

PARTS CHECKLIST

1. Handset
2. Base Unit
3. AC Power Adaptor
4. Battery Pack
5. Wall Mounting Bracket
6. Telephone Line Cord
7. Belt Clip

To purchase replacement battery packs, call **VTECH** Communications at 1-800-595-9511. In Canada, call VTECH Electronics at 1-800-267-7377.



HANDSET

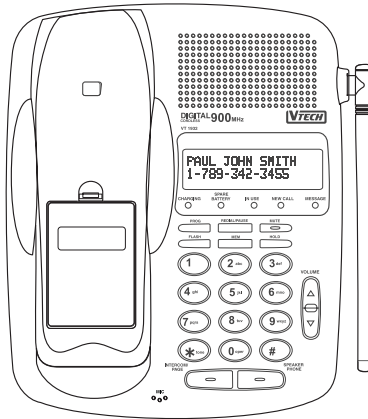

BASE UNIT

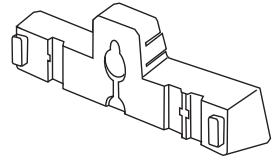

WALL MOUNTING BRACKET

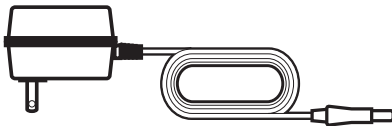

AC POWER ADAPTOR

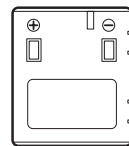

BATTERY PACK



TELEPHONE LINE CORD

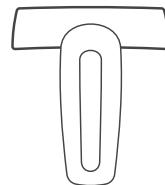

BELT-CLIP

FCC and IC Regulations

This equipment complies with Parts 15 and 68 of the Federal Communications Commission (FCC) rules for the United States. It also complies with regulations RSS210 and CS-03 of Industry and Science Canada. Operation is subject to the following two conditions: (1) this device may not cause interference, and (2) this device must accept any interference, including interference that may cause undesired operation of the device.

A label is located on the underside of the base unit containing either the FCC registration number and Ringer Equivalence Number (REN) or the IC registration number and Load Number. You must, upon request, provide this information to your local telephone company.

This equipment is compatible with inductively coupled hearing aids.

Should you experience trouble with this telephone equipment, please contact:

VTECH COMMUNICATIONS

SERVICE DEPT. at 1-800-595-9511.

In Canada, call VTECH Electronics at 1-800-267-7377.

For repair/warranty information. The telephone company may ask you to disconnect this equipment from the line network until the problem has been corrected.

FCC Part 15

Warning: Changes or modifications to this unit not expressly approved by the party responsible for compliances could void the user's authority to operate the equipment.

The equipment has been tested and

found to comply with part 15 of the FCC rules. These limits are designed to provide reasonable protection against harmful interference in a residential installation. This equipment generates, uses and can radiate radio frequency energy and, if not installed and used in accordance with the instructions, may cause harmful interference to radio communications. However, there is no guarantee that interference will not occur in a particular installation. If this equipment does cause harmful interference to radio or television reception, which can be determined by turning the equipment off and on, the user is encouraged to try and correct the interference by one or more of the following measures:

- Reorient or relocate the receiving antenna.
- Increase the separation between the equipment and receiver.
- Connect the equipment into an outlet or on a circuit different from that to which the receiver is connected.
- Consult the dealer or an experienced radio/TV technician for help.

FCC Part 68

The FCC requires that you connect your cordless telephone to the nationwide telephone network through a modular telephone jack (USOC RJ11C, RJ11W or RJ14).

Your telephone company may discontinue your service if your equipment causes harm to the telephone network. They will notify you in advance of disconnection, if possible. During notification, you will be informed of your right to file a complaint with the FCC.

Occasionally, your telephone company

FCC AND IC REGULATIONS

may make changes in its facilities, equipment, operation, or procedures that could affect the operation of your equipment. If so, you will be given advance notice of the change to give you an opportunity to maintain uninterrupted service.

The base unit contains no user serviceable parts. The handset contains a user replaceable battery pack.

If it is determined that your telephone equipment is malfunctioning, the FCC requires that it not be used and that it be unplugged from the modular jack until the problem has been corrected. Repairs to this telephone equipment can only be made by the manufacturer or its authorized agents or by others who may be authorized by the FCC. For repair procedures, follow the instructions outlined under the manufacturer's Limited Warranty.

This equipment may not be used on coin service provided by the phone company or Party Lines.

The REN is useful in determining the number of devices you may connect to your telephone line and still enable the devices to ring when you receive a call. The general rule is that the REN value should not exceed 5.0 total; however, contact your local telephone company for the specific number in your area.

IC (Industry Canada)

This telephone is registered for use in Canada.

Notice: The REN assigned to this device denotes the number of devices you may connect to the telephone loop, which is used by the device to prevent

overloading. The termination on a loop may consist of any combination of devices subjected only to the requirement that the sum of the REN does not exceed five (5.0)

Notice: The Industry Canada label identifies certified equipment. This certification means that the equipment meets certain telecommunications network protective, operational and safety requirements. The Department does not guarantee the equipment will operate to the user's satisfaction.

FCC AND IC REGULATIONS

Before installing this equipment, users should ensure that it is permissible to be connected to the facilities of the local telecommunications company. The equipment must also be installed using an acceptable method of connection. The customer should be aware that compliance with the above conditions may not prevent degradation of services in some situations.

Repairs to certified equipment should be made by an authorized Canadian maintenance facility designated by the supplier. Any repairs or alterations made by the user to this equipment, or equipment malfunctions, may give the telecommunications company cause to request the user to disconnect the equipment.

Users should ensure for their own protection that the electrical ground connections of the power utility, telephone lines and internal metallic water pipe system, if present, are connected together. This precaution may be particularly important in rural areas.

Caution: Users should not attempt to make such connections themselves, but should contact the appropriate electrical inspection authority, or electrician, as appropriate.

Your **VT 1932** is designed to operate at the maximum power allowed by the FCC . This means your handset and base unit can communicate only over a certain distance - which will depend on the location of the base unit and handset, weather, and the construction and layout of your home or office.

IMPORTANT SAFETY INSTRUCTIONS

When using your telephone equipment, basic safety precautions should always be followed to reduce the risk of fire, electric shock and injury to persons, including the following:

1. Read and understand all instructions.
2. Follow all warnings and instructions marked on the product.
3. Unplug this product from the wall outlet before cleaning. Do not use liquid cleaners or aerosol cleaners. Use a dry cloth for cleaning.
4. Do not use this product near water, for example, near a bath tub, wash bowl, kitchen sink, or laundry tub, in a wet basement, or near a swimming pool.
5. Do not place this product on unstable cart, stand, or table. The telephone may fall, causing serious damage to the telephone.
6. Slots and openings in the cabinet and the back or bottom are provided for ventilation, to protect it from overheating, these openings must not be blocked or covered. The openings should never be blocked by placing the product on the bed, sofa, rug, or other similar surface. This product should never be placed near or over a radiator or heat register. This product should not be placed in a built-in installation unless proper ventilation is provided.
7. This product should be operated only from the type of power source indicated on the marking label. If you are not sure of the type of power supply to your home, consult your dealer or local power company.
8. Do not allow anything to rest on the power cord. Do not locate this product where the cord will be abused by persons walking on it.
9. Do not overload wall outlets and extension cords as this can result in the risk of fire or electric shock.
10. Never push objects of any kind into this product through cabinet slots as they may touch dangerous voltage points or short out parts that could result in a risk of fire or electric shock. Never spill liquid of any kind on the product.
11. To reduce the risk of electric shock, do not disassemble this product, but take it to a qualified service personnel when some service or repair work is required. Opening or removing covers may expose you to dangerous voltages or other risks. Incorrect reassembly can cause electric shock when the appliance is subsequently used.
12. Unplug this product from the wall outlet and refer servicing to qualified service personnel under the following conditions:
 - A. When the power supply cord plug is damaged or frayed.
 - B. If liquid has been spilled into the product.

IMPORTANT SAFETY INSTRUCTIONS

- C. If the product has been exposed to rain or water.
- D. If the product does not operate normally by following the operating instructions. Adjust only those controls, that are covered by the operating instructions because improper adjustment of other controls may result in damage and will often require extensive work by a qualified technician to restore the product to normal operation.
- E. If the product has been dropped or the cabinet has been damaged.
- F. If the product exhibits a distinct change in performance.
- 13. Do not use the telephone to report a gas leak in the vicinity of the leak.

CAUTION: TO REDUCE THE RISK OF FIRE OR INJURY TO PERSONS BY BATTERY, READ AND FOLLOW THESE INSTRUCTIONS.

1. Use only the appropriate type and size battery pack specified in the instruction manual provided for this product.
2. Do not dispose of the battery pack in a fire. The cell may explode. Check with State and local codes for possible special disposal instructions.
3. Do not open or mutilate the battery pack. Released electrolyte is corrosive and may cause damage to the eyes or skin. It may be toxic if swallowed.
4. Exercise care in handling battery in order not to short the battery with conducting materials such as rings, bracelets, and keys. The battery or conductor may overheat and cause burns.
5. Charge the battery pack provided with or identified for use with this product only in accordance with the instructions and limitations specified in the instruction manual.
6. Observe proper polarity orientation between the battery pack and battery charger.

SAVE THESE INSTRUCTIONS

GETTING STARTED

- Plug the **AC POWER ADAPTER** into a live electrical outlet and the **DC POWER CONNECTOR** into the back of the Base Unit.

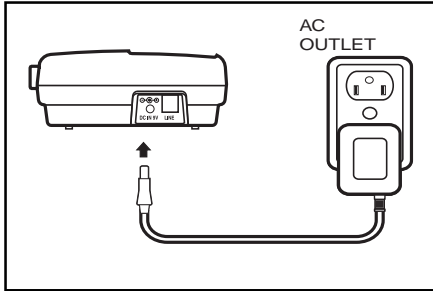

- Slide the Handset battery cover down, and remove it from the Handset.

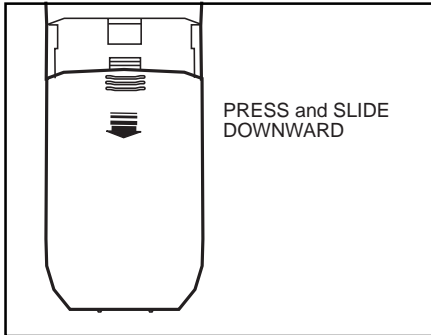

- Install the **BATTERY PACK**, with the metal contacts facing down and aligned with the Handset contacts. Replace Handset battery cover.

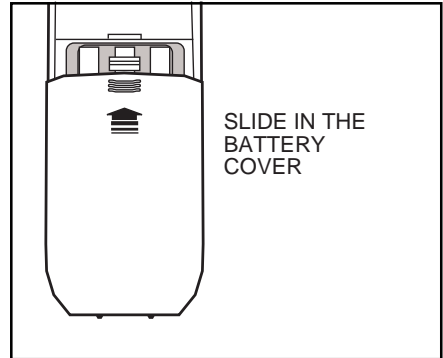
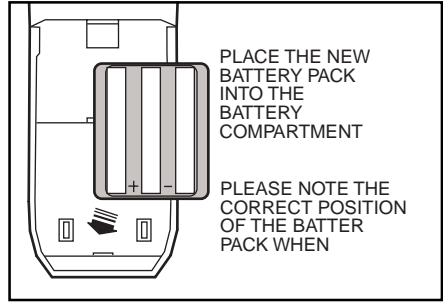

- Place the Handset into the Base Unit cradle. Make sure the Charging light is illuminated. **Charge for at least 16 hours before first using the phone.** The Handset can charge face up or down.
- Set the **TONE/PULSE** switch, located on the antenna side of the Base Unit, to the desired dialing mode. In most areas, **TONE** is the desired mode.

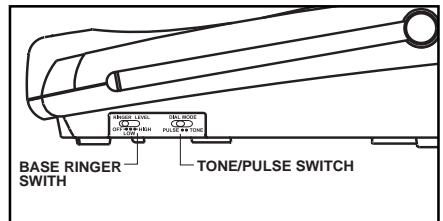

- After charging the battery pack, connect the telephone line cord to a live telephone outlet and the TEL. LINE jack, located on the back edge of the Base Unit.
- If your Base Unit is not connected to a live telephone outlet, the Handset will display:

CHECK TEL. LINE

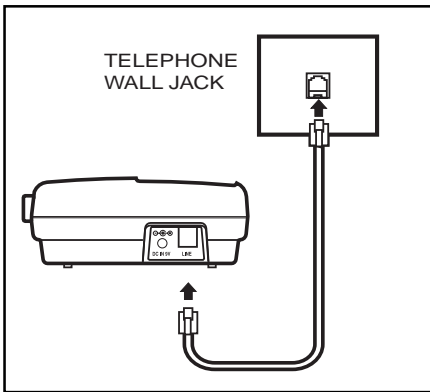

For best results, raise the antenna on the Base Unit and Handset when using the phone.



The RBRC® Seal on the (easily removable) nickel-cadmium battery (contained in our product) indicates that VTech Communications, INC. is

voluntarily participating in an industry program to collect and recycle these batteries at the end of their useful lives, when taken out of service within the United States and Canada.

The RBRC® program provides a convenient alternative to placing used nickel-cadmium batteries into the trash or municipal waste, which be illegal in your areas.

VTech's payments to RBRC® make it easy for you to drop off the spent battery at local retailers participating in the RBRC® program or at authorized VTech product service centers. Please call **1-800-8-BATTERY™** for information on Ni-Cd battery recycling and disposal bans/restrictions in your area. VTech's involvement in this program is part of its commitment to protecting our environment and conserving natural resources.

Remove the nickel-cadmium battery pack by pressing on the lock knob and sliding downward as mentioned on this manual.

RBRC® is a registered trademark of Rechargeable Battery Recycling Corporation.

WALL MOUNTING

The Wall Mounting bracket is designed to fit on standard Wall Mounting plates

1. Choose a spot near an electrical outlet and a telephone jack.

Your phone requires a modular telephone jack and a standard electrical outlet (120v AC). The power cord is six feet long; make sure there is an electrical outlet within reach of the Base Unit. The outlet should not be controlled by a wall switch. If the switch is ever turned off, the phone will not operate.

2. Position the wall mount bracket on the base.

Line up the tabs on the wall mounting bracket with the holes on the bottom of the base. Snap the wall mounting bracket firmly into place.

3. Mount the base on the wall.

Position the base so the mounting studs will fit into the holes on the bottom of the base. Position the power cord to extend down the wall. Slide the base down on the mounting studs until it locks into place.

4. Connect the telephone line cord.

Insert one end into the TEL.LINE jack on the back edge of the base. Insert the other end into the wall jack.

5. Plug the AC adapter into an electrical outlet and the DC connector into the power jack located on the back of the Base Unit .

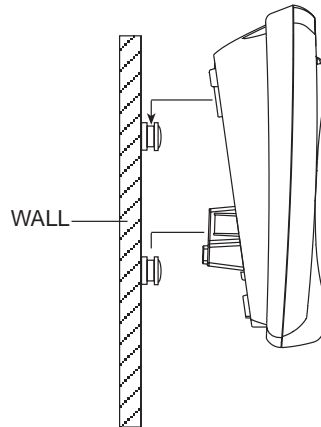
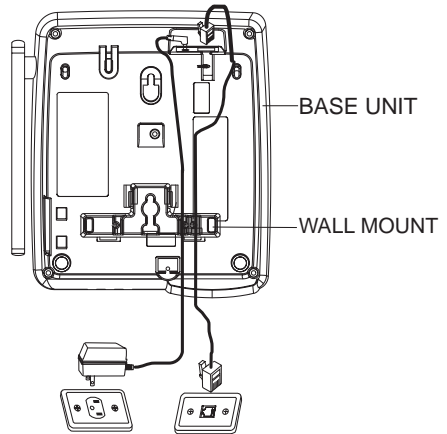

HANDSET UNIT KEYS AND FEATURES

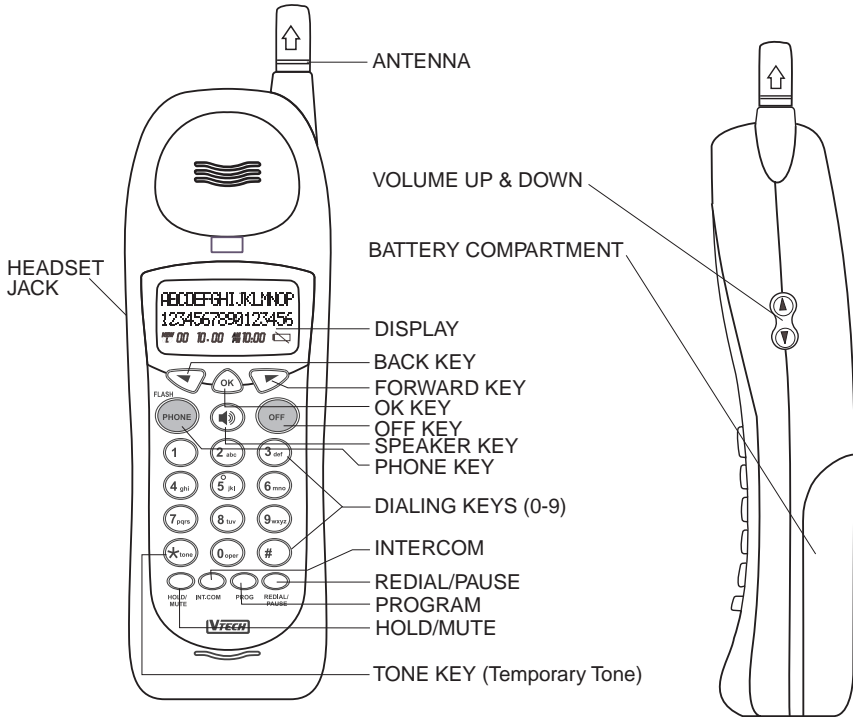

BASE UNIT KEYS AND FEATURES

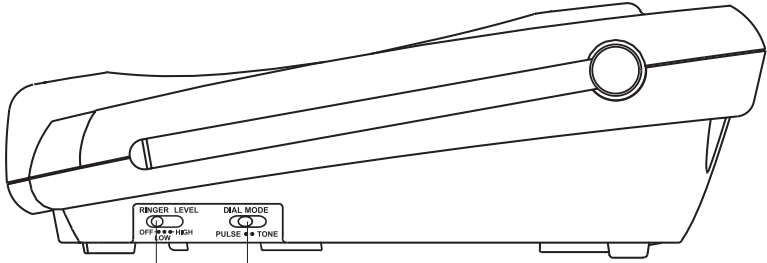
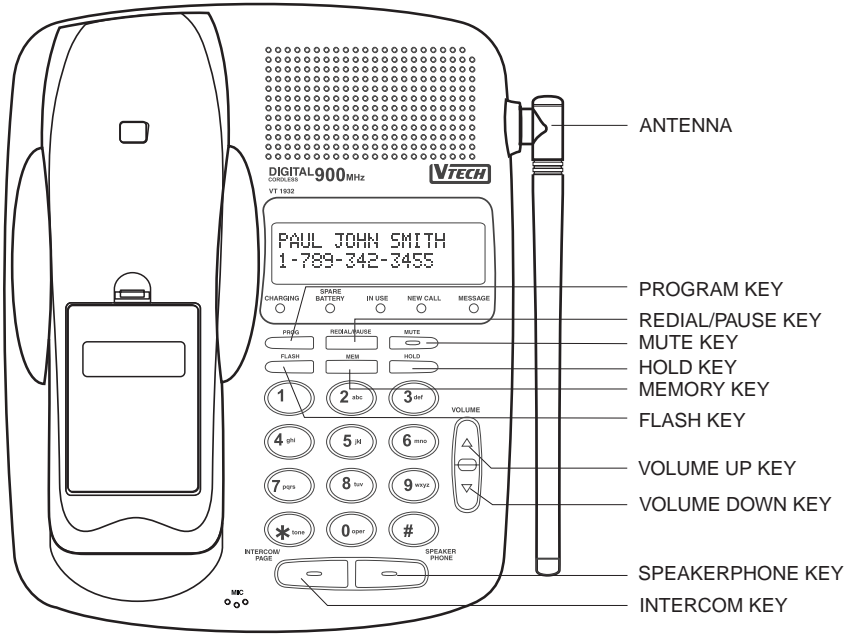

BASE RINGER SWITCH **TONE/PULSE SWITCH**

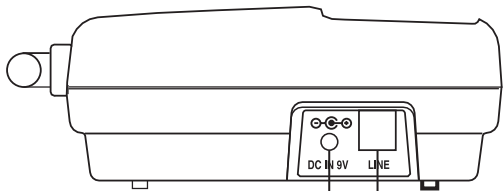



AC POWER JACK
PHONE CORD JACK

BASIC TELEPHONE OPERATIONS

AREA CODE PROGRAMMING



To benefit from all the Caller ID features of your telephone, you must enter your home area code.

If you live in an area where you dial calls within your own area code by dialing 7 digits (no area code), follow these steps (with the Handset **OFF**):



- Press **Program**.
- Press  until **AREA** is blinking.
- Press **Select**.
- **HOME** should be blinking. If not, press  until it blinks.
- Press **Select**. **ENTER AREA CODE** is displayed.
- Enter your **own home area code**.
- Press **Select**.

LESS COMMON ALTERNATIVE

If you live in an area where all local calls require 10 digits (area code plus phone number, without dialing “1” first):

- Press **Program**.
- Press  until **AREA** is blinking.
- Press **Select**.
- **HOME** should be blinking. If not, press  until it blinks.
- Press **Select**. **ENTER AREA CODE** is displayed.
- Enter **000**.
- Press **Select** and continue below.

You may program up to 5 local area codes. An area code is “local” if you do not dial “1” when you make calls to that area code. In other words, you make calls to “local” area codes by dialing 10 digits (area code plus phone number) without a preceding “1”. This might include your own area code

- Press **Program**.
- Press  until **AREA** is blinking.
- Press **Select**.
- Press  until **LOCAL** is blinking. Press **Select**.

- Press  until the desired location is blinking (**#1.....#5**).
- Press **Select**. **ENTER AREA CODE** is displayed.
- Enter a “local” area code.
- Press **Select**.

NOTE: To replace or edit an existing area code, use the  key to delete the existing digits, and enter the desired area code. Press **Select** when done.

MAKING CALLS

Handset: Press **PHONE**. Listen for Dial Tone. Dial the phone number. Press **OFF** to end your call.

Cordless Speakerphone:

Press  on the Handset. Dial the number. The Handset can now be used as a cordless speakerphone. You can hold it in your hand or place it standing up on a table. To end a call, press **OFF**.

CALL TIMER

While the Handset is **ON**, the approximate duration of your call is displayed.

Base Unit Speakerphone:

Press **Speakerphone** on the base. Dial the number. To end a call, press **Speakerphone** again.

SPEAKERPHONE TIPS

If you use your Speakerphone in a noisy environment, the other person’s voice may fade out. In this case, try eliminating the environmental noise (a television or radio playing, for example). Otherwise, press **Mute** while the other person is speaking. Before you start to talk, press **Mute** again so the other person can hear you.

BASIC TELEPHONE OPERATIONS

REDIAL/PAUSE

Press **PHONE** or the Handset  key.
Press **Redial/Pause**.
The last number you called will be redialed.

ANSWERING CALLS

Handset: Press **PHONE**. **TALK** is displayed on the Handset. Press **OFF** to end your call.

Cordless Speakerphone: Press  on the Handset. The Handset answers the call as a cordless speakerphone. You can hold it in your hand or place it standing up on a table. To end a call, press **OFF**.

Base Unit Speakerphone: Press **Speakerphone** on the Base. To end the call, press **Speakerphone** again.

LINE IN USE

The **LINE IN USE** indicator on the Base Unit will illuminate when the Handset, or an extension phone sharing the same line is in use.

BASE IN USE

In the **OFF** (on hook) mode, the Handset will display **BASE IN USE** if the Base Speakerphone is in use.

HANDSET VOLUME

Adjust the Handset volume with the ▲ and ▼ keys, located on the side of the Handset. There are 4 volume levels.

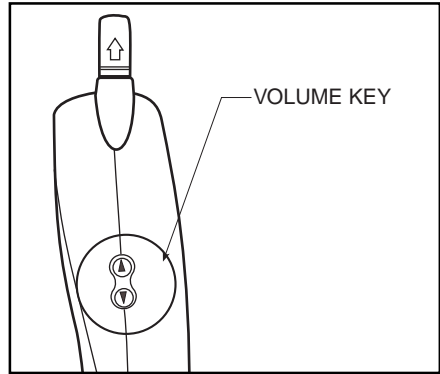

MUTE

When you mute a call, the other person cannot hear you, but you can hear them. To mute a Handset call, press **Mute/Hold** during the call. The Handset will display **MUTE**. You can still hear the other person talk, but they cannot hear you. Press **Mute/Hold** again to return to normal 2-way conversation.

HOLD

To put a Handset call on hold, press and hold the **Mute/Hold** key for 2 seconds. The Handset will display **HOLD**. Neither you nor the other person can hear each other. Press **PHONE** or  to return to normal 2-way conversation.

CALL WAITING

If you subscribe to Call Waiting, you will hear a tone when you receive a second call while on the phone. If you subscribe to Caller ID on Call Waiting, the Handset displays who is calling before you answer.

To answer Call Waiting during a normal handset call, press **PHONE**. To answer during a Handset **Speakerphone** call, press . To answer during a Base Unit Speaker call, press **Flash** on the Base.

BASIC TELEPHONE OPERATIONS

PAGING THE HANDSET

- To make the Handset ring, press **Intercom** on the Base.
- To stop the ringing, press **OFF** on the Handset.

INTERCOM

(Conversation between the Base and Handset)

From the Handset: Press **Intercom**. The Base Unit will ring, and the intercom call will be *automatically* connected.

From the Base: Press **Intercom**. The Handset will ring. To answer the call, press **Intercom** on the Handset.

To end an Intercom call, press **OFF** on the Handset or **Intercom** on the Base.

VOICE MAIL INDICATOR

If you subscribe to Voice Mail, the **Voice Mail** light on the Base Unit will flash when you have new messages. The Handset will display:

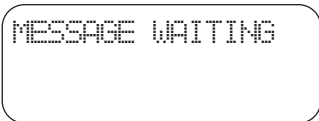

Once you have reviewed your new messages, the MESSAGE WAITING indication on the Handset, and the Voice Mail light on the Base will turn off.

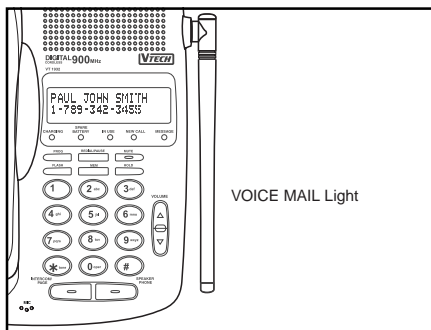

VOICE MAIL TIOP:

After hearing your messages, wait until the Voice Mail indicators turn off before you make another call. This will ensure the indicators do not remain on after the messages are reviewed.

If, after reviewing all new voice messages, the Handset or Base Unit Voice Mail indicator remains on, using the Handset, follow these steps:

- Press **Program**.
- Press **#**. The Handset displays:

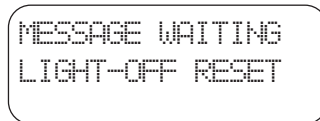

- With **LIGHT-OFF** flashing, press **Select**.

If you have new messages, but the Voice Mail indicators do not turn on, ask your phone company to make sure your Voice Mail service has Visual Message Indication assigned.

SETTING THE HANDSET RINGER

- Press **Program**.
- Press **Left Arrow** until **RINGER** is blinking.
- Press **Select**. **TYPE** is blinking.
- Press **Select**.





There are 4 ringer styles. The current setting is blinking.

- Press **Left Arrow** or **Right Arrow** to hear the other ringer styles OR turn the Handset ringer **OFF**.
- When the desired ringer type is blinking, press **Select**.

To turn the Handset ringer ON again, follow the steps in, "**Setting the Handset Ringer**".

BASIC TELEPHONE OPERATIONS

HANDSET RINGER VOLUME

- Press **Program**.
- Press  until **RINGER** is blinking.
- Press **Select**.
- Press  until **VOL** is blinking.
- Press **Select**.
- Press  or  to raise or lower the ringer volume.
- When the desired setting is blinking, press **Select**.

BASE UNIT RINGER

The Base Unit ringer volume is controlled by a switch on the right edge of the Base. It can be set to Off, Low, or High volume.

HANDSET SPEAKERPHONE FEATURE

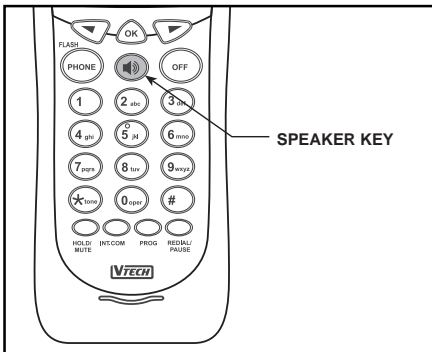

Press the  to make or answer a call using the Handset Speakerphone. The Handset displays **SPEAKERPHONE**. You can now talk hands-free, away from the Base Unit. Press **OFF** to end a call.

Call Waiting: If you hear a Call Waiting tone during a speakerphone call, press the  key to answer it. (Do not use the **PHONE** key to answer Call Waiting while using the speakerphone.)

Switching from Speakerphone to Ear-piece: At any time during a Handset

speaker call, you can press **PHONE** to switch to a non-speaker call. The Handset will display **TALK**, and you can hold the handset to your ear normally. Press  whenever you want to change back to the Speakerphone. The Handset will display **SPEAKERPHONE**.

CALLER ID

This telephone provides three types of Caller ID:

Caller ID: Displays the name and number of each caller after the phone begins ringing (requires Caller ID service from your telephone company).





Caller ID on Call Waiting: Shows the name and number of each caller on Call Waiting after you hear the Call Waiting tone (requires Caller ID on Call Waiting service).

Voice Announce: Announces aloud the name or number of each caller while displaying it on the Handset (requires Caller ID service).

The phone has a Call Log, which stores the name, number, date, and time of the last 50 calls received. You can review the Call Log to see who called while you were out. You can speed-dial numbers from the Call Log. And you can store names and numbers from the Call Log into your directory.

REVIEWING THE CALL LOG

With the Handset OFF:

- Press  or . You will see the number of NEW (not viewed) and OLD (previously viewed) calls.
- Continue to press  or  to review the callers.

Some locations are not equipped to send Caller ID information when a person places a call. When you receive calls from such locations, your phone will display **UNAVAILABLE**.

If a caller purposely blocks their phone number from being delivered by Caller



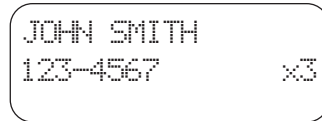

ID, your phone will display **PRIVATE**.

HINT: If an x_ follows the phone number (x3 for example) it indicates the party has called more than once.







ERASING CALLS

To erase a call; with the Handset OFF:

- Press  or  until you see the call you want to erase.
- Press **Select**.
- Press  until **ERASE** is blinking. Press **Select**.
- Press  until **YES** is blinking. Then press **Select**.

To erase your entire Call Log; after you have viewed all calls and the handset is off:

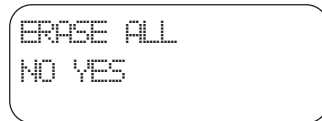

- Press  or  until you see any call in the log.
- Press **Select**.
- Press  until **ERASE** is blinking. Press **Select**.
- Press  until **ALL** is blinking. Then press **Select**. The handset displays:



- Press  until **YES** is blinking. Then press **Select**.

SPEED DIALING FROM CALLER ID

With the Handset OFF:

- Press  or  until you see the desired caller.
- Press **PHONE**. You will hear a dial tone, and the number will be dialed automatically.

DIRECTORY

TO STORE A NAME, NUMBER, AND VOICE ANNOUNCE RECORDING:

- Press **Program**. **DIRECTORY** will be blinking.
- Press **Select**.
- The screen will display **ENTER NAME**.

Use the Dialing keys to enter the desired name. Press the key until the desired letter or character appears. A guide to the characters:

<u>KEY</u>	<u>C H A R A C T E R S</u>
1	1
2	A>B>C>2
3	D>E>F>3
4	G>H>I>4
5	J>K>L>5
6	M>N>O>6
7	P>Q>R>S>7
8	T>U>V>8
9	W>X>Y>Z>9
0	0
*	*
#	& ' , - . # @

If consecutive characters are found on the same key (*D* and *E*, for example), you'll need to press  to advance to the next space. For example, to enter the name **DEAN**:

Press	3	(<i>D</i>)
Press		
Press	3 <i>twice</i>	(<i>E</i>)
Press	2	(<i>A</i>)
Press	6 <i>twice</i>	(<i>N</i>)

When the name is complete, press **Select**. The screen will display:



```
DEAN
ENTER NUMBER
```



Enter the phone number. Press **Redial/**

Pause if you need to enter a 2-second pause in the dialing sequence. (For example, you might store a voice mail access number, pause, password.)

When the phone number is complete, press **Select** .

STORING A CALLER ID RECORD IN THE DIRECTORY

With the Handset **OFF**:





- Press  or  until you see the desired call.
- Press **Select** .
- Press  until **EDIT** is blinking. Press **Select** .

If you want to edit the name, press  to erase letters. Use the dialpad to enter new letters. When the name is correct, press **Select** .

If you want to edit the number, press  to erase digits. Use the dialpad to enter new digits. When the number is correct, press **Select** .

You will then hear a long beep. The name and number have been stored in the Directory. If you want to record this person's name for Voice Announce Caller ID, you will need to edit the entry and add a recording at that time. See the section, "**Editing a Directory Entry**."

MAKING DIRECTORY CALLS

- Press **Select**. **DIRECTORY** will appear.
- Press  or  to scroll to the desired name; **or**, search by entering the first letter of the name, and then press  or  if necessary.
- Press **PHONE**. You will hear a dial tone, and the number will be dialed.

DIRECTORY

EDITING A DIRECTORY ENTRY

- Press **Select** . The Handset says **DIRECTORY**.
- Press ◀ or ▶ to scroll to the desired name; *or*, search by entering the first letter of the name, and then press ◀ or ▶ if necessary.
- Press **Select** .
- Press ▶ until **EDIT** is blinking.
- Press **Select** .The name appears.
- If you want to edit the name, press ◀ to erase letters. Use the dialpad to enter new letters. When the name is correct, press **Select** .

The number appears. If you want to edit the number, press ◀ to erase digits. Use the dialpad to enter new digits. When the number is correct, press **Select**.

The handset displays several options that let you hear the recorded name or re-record or erase it. Press ◀ or ▶ until the desired option is blinking. Press **Select** .

ERASING A DIRECTORY ENTRY

- Press **Select** .
- Press ◀ or ▶ to scroll to the desired name; *or*, search by entering the first letter of the name, and then press ◀ or ▶ if necessary.
- Press **Select** .
- Press ▶ until **ERASE** is blinking.
- Press **Select**. Press ▶ until **YES** is blinking.
- Press **Select** .

PROGRAMMING SPEED DIAL NUMBERS IN THE BASE UNIT

With the Base Unit OFF:

- Press **Program**
- Press **Memory**

- Enter desired Location (**0-9**)
- Enter the Phone Number
- Press **Program**

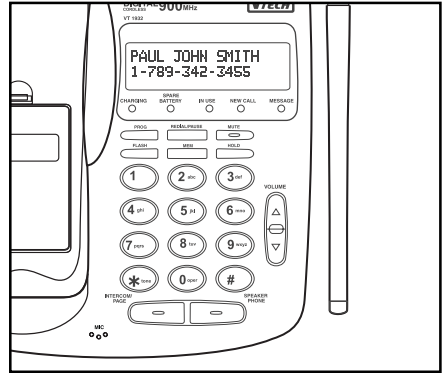

SPEED DIALING FROM THE BASE UNIT

- Press **Speakerphone**
 - Press **Memory**•Enter Location (**0-9**)
- ### Taking Care Of Your Telephone

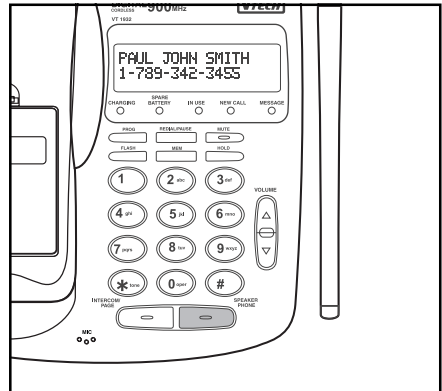

HEADSET OPERATIONS

Your **VTech** cordless phone is equipped with a 2.5mm headset Jack for use with an optional accessory Headset for hands-free operation.

If you choose to use the Headset option, you must obtain an optional accessory Headset, which is compatible with the **VTech** cordless phone.

To purchase a Headset, call VTech Customer Service at 1-800-595-9511. In Canada, call **VTECH** Electronics at 1-800-267-7377.

Once you have a compatible 2.5mm Headset, locate the Headset Jack on the **VTech** cordless phone Handset. Connect the plug on the Headset cord to the jack on the cordless Handset. The plug should fit securely. Do not force the connection.

OPERATION

NOTE: Whenever a compatible Headset is connected to the cordless Handset, the microphone on the Handset will be muted. This is done to limit the effect of background noise.

The following operational characteristics also apply to other headsets which are not sold by **VTech**; however, **VTech** assumes no responsibility for their performance.

The **VTech** compatible Headset has a reversible, monaural design. You can wear you Headset on either ear, leaving one ear free for room conversation.

The headband can be adjusted to fit the contour of you head. Using both hands, slide the headband up or down so that it rests comfortably on your head, with the speaker cushion centered against your ear.

For maximum sound quality, the flexible microphone should be positioned at the corner of your mouth, about one inch from your face.

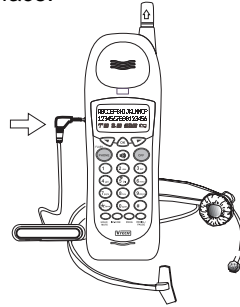

BELT CLIP

The **VTech** cordless phone is also equipped with a detachable belt clip. Align the pins on the inside edge of the clip with the notches on the sides of the **VTech** cordless phone Handset. The belt clip should snap securely into place. Do not force the connection.

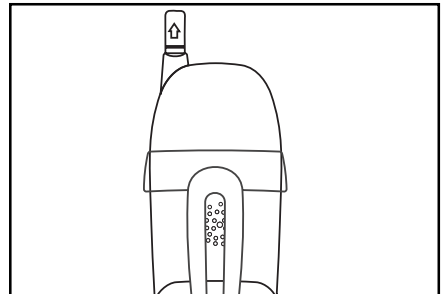

POWER BACKUP

When a spare battery pack (optional) is installed in the Base Unit, your VTech cordless telephone uses this battery to provide operational backup during a power failure. If you have a fully charged battery pack in the Base Unit charger, you will be able to place and receive calls from the Handset for up to **5** hours.

Note:

During power backup mode, the Base Unit functions are not operable. In addition, Caller ID information may not be reliable.

REPLACING A DRAINED HANDSET BATTERY

The spare battery pack can also be used to replace a drained Handset battery, to ensure uninterrupted use. Be sure to put the drained battery pack in the Base Unit charger for recharging.

The Base Unit battery compartment charges at a slower rate than a battery pack charging in the Handset. It takes **24** hours to fully charge a battery pack in the Base Unit.

To purchase replacement battery packs, call **VTECH** Communications at 1-800-595-9511. In Canada, call VTECH Electronics at 1-800-267-7377.

Taking Care Of Your Telephone

Your **VT 1932** cordless telephone contains sophisticated electronic parts, so it must be treated with care.

Avoid rough treatment

Please the Handset down gently. Save the original packing materials to protect your telephone if you ever need to ship it.

Avoid water

Your telephone can be damaged if it gets wet. Do not use the Handset outdoors in the rain, or handle it with wet hands. Do not install your Base Unit near a sink, bathtub or shower.

Electrical storms

Electrical storms can sometimes cause power surges harmful to electronic equipment.

For your own safety, use caution when using electric appliances during storms.

Cleaning your telephone

Your telephone has a durable plastic casing that should retain its luster for many years. Clean it only with a soft cloth slightly dampened with water or a mild soap. Do not use excess water or cleaning solvents of any kind.

Remember that electrical appliances can cause serious injury if used when you are wet or standing in water. If your Base Unit should fall into water, **DO NOT RETRIEVE IT UNTIL YOU UNPLUG THE POWER CORD AND TELEPHONE LINE CORDS FROM THE WALL.** Then pull the unit out by the unplugged cords.

IN CASE OF DIFFICULTY

If you have difficulty operating your phone, the suggestions below should solve the problem. If you still have difficulty after trying these suggestions, call **VTECH Communications** at 1-800-595-9511. In Canada, call **VTECH Electronics** at 1-800-267-7377.

THE PHONE DOESN'T WORK AT ALL.

- Make sure the Power Cord is plugged
- Make sure the telephone line cord is plugged firmly into the base unit and the telephone wall jack.
- Make sure the batteries are properly charged. If the 'LOW BATTERY' message is shown, the battery pack needs charging.

NO DIAL TONE.

- First check all the suggestions above.
- If you still don't hear a dial tone, disconnect the base unit from the telephone jack and connect a different phone. If there is no dial tone on that phone either, the problem is in your wiring or local service. Call your local telephone company.

YOU GET NOISE, STATIC, OR A WEAK SIGNAL EVEN WHEN YOU'RE NEAR THE BASE UNIT.

- Household appliances plugged into the same circuit as the base unit can sometimes cause interference. Try moving the appliance or the base unit to another outlet.

YOU GET NOISE, STATIC, OR A WEAK SIGNAL WHEN YOU'RE AWAY FROM THE BASE UNIT.

- You may be out of range. Either move close to the base, or relocate the base unit.

- The layout of your home may be limiting the range. Try moving the base unit to another position.

THE HANDSET DOES NOT RING WHEN YOU RECEIVE A CALL.

- Make sure you have the handset ringer activated. To set the ringer, see "**HANDSET RINGER VOLUME**".
- Make sure the telephone line cord is plugged firmly into the base unit and the telephone jack. Make sure the power cord is plugged in.
- You may be too far from the base unit.
- You may have too many extension phones on your telephone line to allow all of them to ring. Try unplugging some of the other phones.

YOU HEAR OTHER CALLS WHILE USING YOUR PHONE.

- Disconnect your base unit from the telephone jack, and plug in a regular telephone. If you still hear other calls, the problem is probably in your wiring or local service. Call your local telephone company.

YOU HEAR NOISE IN THE HANDSET, AND NONE OF THE KEYS OR BUTTONS WORK.

Make sure the power cord is plugged in.

COMMON CURE FOR ELECTRONIC EQUIPMENT

Electronics, like people, can sometimes get confused. If the unit does not seem to be responding normally, then try putting the handset in the cradle. If it does not seem to respond after trying this a few times, do the following (in the order listed):

1. Disconnect the power to the base.

IN CASE OF DIFFICULTY

2. Disconnect (remove) the handset battery pack.
3. Remove the base unit battery pack, where applicable.
4. Wait a few minutes.
5. Connect power to the base.
6. Install the handset battery pack.
7. Install the base unit battery pack, where applicable.
8. Place the handset in the base unit cradle. If the handset has not been recently charged, allow 8 hours before use.

LIMITED WARRANTY

WHAT DOES OUR WARRANTY COVER?

- Any defect in material or workmanship.

FOR HOW LONG AFTER THE ORIGINAL PURCHASE?

- To the original purchaser only - ONE YEAR.

WHAT WILL VTECH DO?

- At our option, repair or replace your unit.

HOW DO I SEND MY UNIT, IN OR OUT OF WARRANTY?

- Call VTECH Communications customer service for Return Authorization at:
1-800-595-9511
in Canada, call VTECH Electronics at:
1-800-267-7377.
- Properly pack your unit. Include any cables & accessories which were originally provided with the product. We recommend using the original carton and packing materials.
- Include in the package a copy of the sales receipt or other evidence of date of original purchase (if the unit was purchased within the last twelve months).
- Print your name and address, along with a description of the defect, and include this in the package.
- Include payment for any service or repair not covered by warranty, as determined by VTECH Communications.
- Ship the unit via UPS Insured, or equivalent to:

VTECH COMMUNICATIONS
8770 SW NIMBUS AVENUE
BEAVERTON, OREGON 97008

in Canada, ship the unit via UPS Insured, or equivalent to:

VTECH ELECTRONICS
Suite 200- 7671 Alderbridge Way
Richmond, B.C. V6X 1Z9

VTECH Communications assumes no responsibility for units sent without prior Return Authorization.

WHAT DOES OUR WARRANTY NOT COVER?

- Batteries
- Damage from misuse, neglect, or acts of nature (lightning, floods, power surges, etc.)
- Products which may have been modified or incorporated into other products
- Products purchased and/or operated outside the USA, its territories, or Canada.
- Products serviced by the owner or a service facility not expressly authorized by VTECH Communications
- Products purchased more than 12 months from current date
- Units purchased in "AS IS" condition, or units purchased as "Distressed Merchandise".

HOW DOES STATE LAW OR PROVINCE LAW RELATE TO THIS WARRANTY?

- This warranty gives you specific rights. You may also have other rights which vary from state to state or from province to province.

TECHNICAL SPECIFICATIONS

FREQUENCY CONTROL

Crystal Controlled Dual PLL Synthesizer

TRANSMIT FREQUENCY

Handset: 923.10 MHz to 927.75 MHz (All ten channels within this range)

Base : 902.3 MHz to 906.65 MHz (All ten channels within this range)

RECEIVE FREQUENCY

Handset: 902.3 MHz to 906.65 MHz (All ten channels within this range)

Base : 923.10 MHz to 927.75MHz (All ten channels within this range)

NOMINAL EFFECTIVE RANGE

Maximum power allowed by FCC and IC. Actual operating range may vary according to environmental conditions at the time of use.

SIZE

Handset: 17.5 x 6 x 4.5cm (L x W x T)
Maximum (Antenna excluded)

Base : 20.5 x 17x 70cm (L x W x T)
Maximum (Antenna excluded)

WEIGHT

Handset: 205 grams
Base : 570 grams

POWER REQUIREMENTS

Handset: Self-contained nickel-cadmium rechargeable battery supply, 3.6V nominal, 600mAh capacity.

Base: 9VDC @ 500mA

MEMORY

Speed Dial:50 Memory locations, 32 digits and 16 letters per location.

CID : Alpha Numeric Display 50 Memory locations

SPECIFICATIONS ARE TYPICAL AND MAY CHANGE WITHOUT NOTICE.

TABLE OF CONTENTS

PARTS CHECKLIST	1
FCC AND IC REGULATIONS	2
IMPORTANT SAFETY INSTRUCTIONS	5
GETTING STARTED	7
WALL MOUNTING	9
HANDSET UNIT KEYS AND FEATURES	10
BASE UNIT KEYS AND FEATURES	11
BASIC TELEPHONE OPERATIONS	
Area Code Programming	12
Making Calls	12
Speakerphone Tips	12
Redial/Pause	13
Answering Calls	13
Handset Volume	13
Mute	13
Hold	13
Call Waiting	13
Paging the Handset	14
Intercom	14
Voice Mail Indicator	14
Voice Mail Tips	14
Setting The Handset Ringer	14
Handset Ringer Volume	15
Base Unit Ringer	15
Handset Speakerphone Feature	15
CALLER ID	
Reviewing the Call Log	16
Erasing Calls	16
Speed Dialing from Caller ID	16
DIRECTORY	
To Store a Name, Number, and Voice Announce Recording	17
Storing a Caller ID Record in the Directory	17

TABLE OF CONTENTS

Making Directory Calls	17
Editing a Directory Entry	18
Erasing a Directory Entry	18
Programming Speed Dial Numbers in the Base Unit	18
Speed Dialing from the Base Unit	18
HEADSET OPERATIONS	19
ADDITIONAL OPERATIONS	20
MAINTENANCE	20
IN CASE OF DIFFICULTY	21
LIMITED WARRANTY	23
TECHNICAL SPECIFICATIONS	24



VTECH COMMUNICATIONS LTD.



Is a trademark of VTECH COMMUNICATIONS LTD., a member of THE VTECH GROUP OF COMPANIES.

Distributed in the U.S.A. by VTECH Communications, 8770 SW Nimbus Avenue / Beaverton, Oregon, 97008.

Distributed in Canada by VTECH Electronics Canada Ltd., Suite 200 - 7671 Alderbridge Way Richmond, B.C. V6X 1Z9.

Copyright 1998 for VTECH COMMUNICATIONS LTD..

91-5083-10-00
ISSUE 0