

USER'S MANUAL

42" WIDE PLASMA DISPLAY

PDS4233W/PDS4234W

Plasmavision™

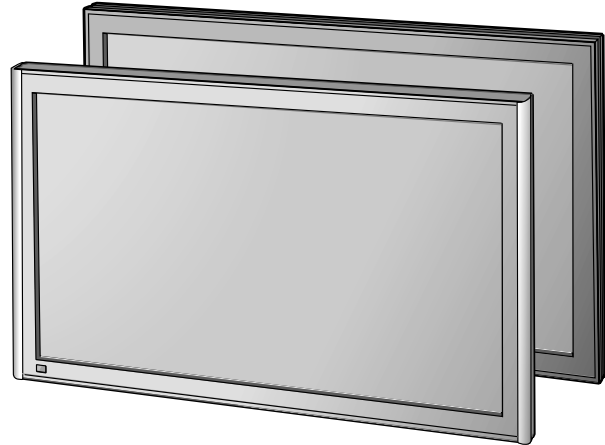

Contents

	Page		Page
Before Use		Adjustments	
• Safety Precautions	2-3	• Adjusting Pictures (PICTURE Menu)	24-25
• Features	4	• Adjusting Screen Position and Size (POSITION/SIZE Menu)	26-27
• Accessories	5	• Adjusting Audio (AUDIO Menu)	28-29
• Handy Tips	5	• Other Adjustments (FEATURES Menu)	30-38
• Installation	6	• Initialization of user adjustment value (FACTORY DEFAULT)	39
Usage		Others	
• Part Names and Functions	7-10	• Options	40
• Using the Remote Control	11	• Factory Settings	41
• Connecting the Display to External Equipment	12-13	• Specification	42
• Basic Operations	14	• Cleaning and Maintenance	44
• Selecting Input Mode	15		
• Watching Pictures on the Wide Screen	16-17		
• How to Use Menus	18-23		

Before using the display, read this manual carefully so that you know how to use the display correctly. Refer to this manual whenever questions or problems about operation arise. Be sure to read and observe the safety precautions.

Keep this manual where the user can see it easily.

** Installation and removal require special expertise. Consult your product dealer for details.*



DECLARATION OF CONFORMITY

according to EN45014

We

Fujitsu General (U.K.) Co. Limited

of

Unit 150, Centennial Park, Centennial Avenue Elstree, Hertfordshire, WD6 3SG

Manufacturer: Shinjyo Fujitsu General Limited
702-3 Kanazawa Shinjyo-shi
Yamagata Japan

declares under our sole responsibility that the product,

Type: 42" PLASMA DISPLAY

Model Name: PDS4233W

to which this declaration relates are in conformity with the following standards;

European Standards:

- EMC: a. EN55022 1994/A1:1995/A2:1997/A3:1998 Class A
b. EN61000-3-2 1995
c. EN61000-3-3 1995
d. EN55024 1998
(EN61000-4-2 1995 / EN61000-4-3 1996)
(EN61000-4-4 1995 / EN61000-4-5 1995 / EN61000-4-6 1996)
(EN61000-4-8 1993 / EN61000-4-11 1994)
- Safety: e. EN60950 1992/A1:1993/A2:1993/A3:1995/A4:1997

*By conformance with the standard referenced, the product follows
the provisions of the directives listed below.*

- a. EC Council Directive 89/336/EEC of 3rd, May 1989
b. EC Council Directive 92/31/EEC of 28th, April 1992
c. EC Council Directive 93/68/EEC of 22nd, July 1993
d. EC Council Directive 73/23/EEC of 19th, February 1973

Place of Issue: United Kingdom

Date of Issue: Oct. 2001

Signature: _____



H. Hirosaki, Chief Executive Officer
Fujitsu General (U.K.) Co. Limited

Declaration reference: Fujitsu General (U.K) Co. Limited

Unit 150, Centennial Park, Centennial Avenue Elstree,
Hertfordshire, WD6 3SG, United Kingdom

Tel: + 44-(0)20-8731-3450

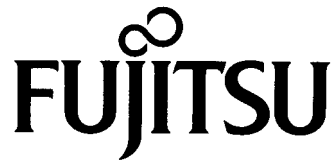
Fax: + 44-(0)20-8731-3451



DECLARATION OF CONFORMITY

according to EN45014

We

Fujitsu General (U.K.) Co. Limited

of

Unit 150, Centennial Park, Centennial Avenue Elstree, Hertfordshire, WD6 3SG

Manufacturer: Shinjyo Fujitsu General Limited
702-3 Kanazawa Shinjyo-shi
Yamagata Japan

declares under our sole responsibility that the product,

Type: 42" PLASMA DISPLAY

Model Name: PDS4234W

to which this declaration relates are in conformity with the following standards;

European Standards:

- EMC: a. EN55022 1994/A1:1995/A2:1997/A3:1998 Class B
b. EN61000-3-2 1995
c. EN61000-3-3 1995
d. EN55024 1998
(EN61000-4-2 1995 / EN61000-4-3 1996)
(EN61000-4-4 1995 / EN61000-4-5 1995 / EN61000-4-6 1996)
(EN61000-4-8 1993 / EN61000-4-11 1994)
- Safety: e. EN60950 1992/A1:1993/A2:1993/A3:1995/A4:1997

*By conformance with the standard referenced, the product follows
the provisions of the directives listed below.*

- a. EC Council Directive 89/336/EEC of 3rd, May 1989
b. EC Council Directive 92/31/EEC of 28th, April 1992
c. EC Council Directive 93/68/EEC of 22nd, July 1993
d. EC Council Directive 73/23/EEC of 19th, February 1973

Place of Issue: United Kingdom

Date of Issue: Oct. 2001

Signature: _____

H. Hirosaki, Chief Executive Officer
Fujitsu General (U.K.) Co. Limited

Declaration reference: Fujitsu General (U.K) Co. Limited

Unit 150, Centennial Park, Centennial Avenue Elstree,
Hertfordshire, WD6 3SG, United Kingdom

Tel: + 44-(0)20-8731-3450

Fax: + 44-(0)20-8731-3451

SAFETY PRECAUTIONS

FCC NOTICE

- PDS4233W: A Class A digital device

This equipment has been tested and found to comply with the limits for a Class A digital device, pursuant to Part 15 of the FCC Rules. These limits are designed to provide reasonable protection against harmful interference when the equipment is operated in a commercial environment. This equipment generates, uses, and can radiate radio frequency energy and, if not installed and used in accordance with the instruction manual, may cause harmful interference to radio communications. Operation of this equipment in a residential area is likely to cause harmful interference in which case the user will be required to correct the interference at his own expense.

- PDS4234W: A Class B digital device

This equipment has been tested and found to comply with the limits for a Class B digital device, pursuant to Part 15 of the FCC Rules. These limits are designed to provide reasonable protection against harmful interference in a residential installation. This equipment generates, uses and can radiate radio frequency energy and, if not installed and used in accordance with the instructions, may cause harmful interference to radio communications. However, there is no guarantee that interference will not occur in a particular installation. If this equipment does cause harmful interference to radio or television reception, which can be determined by turning the equipment off and on, the user is encouraged to try to correct the interference by one or more of the following measures:

- Reorient or relocate the receiving antenna.
- Increase the separation between the equipment and receiver.
- Connect the equipment into an outlet on a circuit different from that to which the receiver is connected.
- Consult the dealer or an experienced radio/TV technician for help.

IMPORTANT INFORMATION

WARNING: This is a Class A and Class B product. In a domestic environment this product may cause radio interference in which case the user may be required to take adequate measures.

WARNING: TO REDUCE THE RISK OF FIRE AND ELECTRIC SHOCK, DO NOT EXPOSE THIS PRODUCT TO RAIN OR MOISTURE.

IMPORTANT SAFEGUARDS

Electrical energy can perform many useful functions. This unit has been engineered and manufactured to assure your personal safety. But **IMPROPER USE CAN RESULT IN POTENTIAL ELECTRICAL SHOCK OR FIRE HAZARD.** In order not to defeat the safeguards incorporated into this product, observe the following basic rules for its installation, use and service. Please read these “Important Safeguards” carefully before use.

- All the safety and operating instructions should be read before the product is operated.
- The safety and operating instructions should be retained for future reference.
- All warnings on the product and in the operating instructions should be adhered to.
- All operating instructions should be followed.
- Unplug this product from the wall outlet before cleaning. Do not use liquid cleaners or aerosol cleaners. Use a damp cloth for cleaning.
- Do not use attachments not recommended by the product manufacturer as they may cause hazards.
- Do not use this product near water. Do not use immediately after moving from a low temperature to high temperature, as this causes condensation, which may result in fire, electric shock, or other hazards.
- The apparatus shall not be exposed to dripping or splashing.
- No objects filled with liquids, such as vases, shall be placed on the apparatus.

- Do not place this product on an unstable cart, stand, or table. The product may fall, causing serious injury to a child or adult, and serious damage to the product. The product should be mounted according to the manufacturer's instructions, and should use a mount recommended by the manufacturer.
- When the product is used on a cart, care should be taken to avoid quick stops, excessive force, and uneven surfaces which may cause the product and cart to overturn, damaging equipment or causing possible injury to the operator.



- Slots and openings in the cabinet are provided for ventilation. These ensure reliable operation of the product and protect it from overheating. These openings must not be blocked or covered. (The openings should never be blocked by placing the product on bed, sofa, rug, or other similar surface. It should not be placed in a built-in installation such as a bookcase or rack unless proper ventilation is provided and the manufacturer's instructions have been adhered to.)

For proper ventilation, separate the product from other equipment, which may prevent ventilation, and keep distance more than 10 cm.

- This product should be operated only from the type of power source indicated on the label. If you are not sure of the type of power supply of your home, consult your product dealer or local power company.
- This product is equipped with a three-wire plug. This plug will fit only into a grounded power outlet. If you are unable to insert the plug into the outlet, contact your electrician to install the proper outlet. Do not defeat the safety purpose of the grounded plug.
- Power-supply cords should be routed so that they are not likely to be walked on or pinched by items placed upon or against them. Pay particular attention to cords at doors, plugs, receptacles, and the point where they exit from the product.
- For added protection for this product during a lightning storm, or when it is left unattended and unused for long periods of time, unplug it from the wall outlet and disconnect the cable system. This will prevent damage to the product due to lightning and power line surges.
- Do not overload wall outlets, extension cords, or convenience receptacles on other equipment as this can result in a risk of fire or electric shock.
- Never push objects of any kind into this product through openings as they may touch dangerous voltage points or short out parts that could result in a fire or electric shock. Never spill liquid of any kind on the product.
- Do not attempt to service this product yourself as opening or removing covers may expose you to dangerous voltages and other hazards. Refer all service to qualified service personnel.
- Unplug this product from the wall outlet and refer service to qualified service personnel under the following conditions:
 - a) When the power supply cord or plug is damaged.
 - b) If liquid has been spilled, or objects have fallen on the product.
 - c) If the product has been exposed to rain or water.
 - d) If the product does not operate normally by following the operating instructions. Adjust only those controls that are covered by the Operation Manual, as an improper adjustment of other controls may result in damage and will often require extensive work by a qualified technician to restore the product to its normal operation.
 - e) If the product has been dropped or damaged in any way.
 - f) When the product exhibits a distinct change in performance—this indicates a need for service.
- When replacement parts are required, be sure the service technician has used replacement parts specified by the manufacturer or with same characteristics as the original part. Unauthorized substitutions may result in fire, electric shock, or other hazards.
- Upon completion of any service or repairs to this product, ask the service technician to perform safety checks to determine that the product is in proper operating condition.
- The product should be placed more than one foot away from heat sources such as radiators, heat registers, stoves, and other products (including amplifiers) that produce heat.
- When connecting other products such as VCR's, and personal computers, you should turn off the power of this product for protection against electric shock.
- Do not place combustibles behind the cooling fan. For example, cloth, paper, matches, aerosol cans or gas lighters that present special hazards when overheated.
- Use only the accessory cord designed for this product to prevent shock.

The power supply voltage rating of this product is AC100–240 V, and the power cord attached conforms to the following power supply voltage. Use only the power cord designated by our dealer to ensure Safety and EMC.

When it is used with other power supply voltage, the power cable must be changed.

Use the standard power plug and cord set of the specified country.

Consult your product dealer.



Power supply voltage: AC 100–125 V (Included)

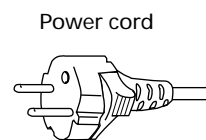

Power cord
AC 200–240 V (Not included)

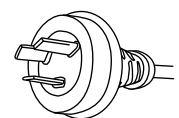

AC 240 V (SAATYPE) (Not included)

FEATURES

This display uses a plasma display panel and is only 8.5 cm deep. With its high picture quality and performance, it is perfectly suited for multimedia applications.

Variety of input signals

- In addition to video, S-video, and RGB, signals, this display supports input of high-quality video signals such as DVD and HDTV.
- The display has an RGB input terminal to receive digital RGB signal of DVI standard to display a high definition picture quality in addition to mD-sub terminal and BNC terminal.
- Depending on the model, the display supports video input for different color television systems as follows: NTSC, PAL, SECAM, PAL60, N-PAL, M-PAL, 4.43NTSC.
- The display has a component video input terminal to receive signals from the DVD player and HDTV equipment as well as digital broadcasting signals (color difference signals).
- The display has an RGB input terminal to receive signals, including VGA, SVGA, XGA and SXGA*1.

5 screen sizes (Video input mode) and 3 screen sizes (RGB input mode)

- This display offers a total of five different screen sizes in video input mode: Normal, Wide1, Wide2, Zoom1, and Zoom2. A Normal mode is also available for displaying of normal-size (4:3 aspect ratio) pictures.
- The display has an Auto mode to switch screen size automatically depending on the contents of software.
- Three different screen sizes in RGB input mode (Normal, Wide, and Zoom) are also available.

Vertical installation

- The display can be installed vertically, enabling advertisement to be displayed. In this case, you can set up the display so that on-screen information, such as input modes and menus, is displayed properly.

Power management function

- The display features a DPMS (Display Power Management Signaling) function that ensures automatic power saving capability.

Flexible as part of a system

- You can operate the display by remote control using the RS-232C interface.
- If you have two or more displays, you can assign a unique number to each of them so that you can select which one you want to use.
- Input Priority function for selecting automatic switching to desired mode is provided to avoid troublesome operation.
- Main unit key lock function can prevent mischief and malfunction.

Others

- Troublesome adjustment of clock phase can be avoided by automatic clock phase adjustment function (Automatic Clock Phase function).
- You can specify the color temperature.
- The white screen and screen orbiter functions are available to minimize phosphor burn-in.
- 2 audio input terminals and 9W + 9W external speaker output terminal are available.
- A clear picture can be obtained by digital noise reduction function.
- A display suitable for such film materials as movie pictures can be made by 24 frame mode function.

*1 The refresh rate of 60, 72, 75 and 85 Hz for SVGA (800 x 600) and those of 60, 70, 75 Hz for XGA (1024 x 768) and those of 60, 75 Hz for SXGA (1280 x 1024) are supported.
Note that the SVGA, XGA and SXGA pictures will be compressed when displayed on the screen.

ACCESSORIES

CHECKING ACCESSORIES

One remote control

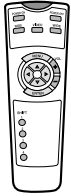

Two AA batteries

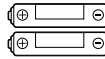

One user's manual

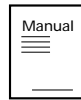

One power cable

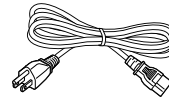

Two ferrite cores

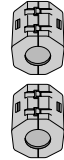

HANDY TIPS

- Pictures may become “burnt” into the screen phosphors if the screen is left on for extended periods. To ensure that the display has a prolonged service life, be sure to use a screen orbiter, white screen. This will ensure the same picture or pattern is not constantly displayed for long periods. (See P. 35-37.)
- The plasma display panel, which is built for maximum precision, provides more than 99.99% effective pixels. You may find, however, that some pixels constantly remain lit or dimmed.
- The display has a fan to prevent its internal temperature from rising.
- Be careful with the air delivered by the fan. It may be very hot.
- Contact your dealer if you find that the display does not seem to function properly when used with other audio-visual equipment. You may need to move your display if it produces degraded pictures or noise due to electromagnetic radiation, or if the infrared remote control does not function properly.
- Pictures may not be displayed properly if you connect a non-standard PC to the RGB input terminal. In this case, contact your dealer for more information.
- The protective circuit, built into the display, automatically turns off the power if the display has a problem. In this case, you will see that the power indicator lamp flashes red.

Warning

If the power indicator lamp flashes red, this signifies that the display has developed a problem. When this happens, be sure to remove the power plug from the receptacle to prevent fire or electric shock. Then, check the display in accordance with the instructions given on P. 44, or contact your dealer.

- Viewing the screen constantly for extended periods can strain your eyes. Be sure to stay at a proper distance (at least 1.5 m or 5 feet) from the screen and to look occasionally away while working.
- Have the display inspected and cleaned by your dealer at regular intervals.

Information

Cables for connecting the display to external equipment are not supplied. Contact your dealer for more information on these products.

INSTALLATION

To prevent the display's internal components from overheating, make sure that the display is installed in a well-ventilated location. Be sure to use the optional stand, wall-mounting unit or the other unit when installing the display. Also, be also sure that your dealer performs the installation.

See the appropriate instruction manual for more information on the installation hardware you select.

To prevent an accident and ensure safety in the event of an earthquake, fix the display securely into position as described below.

To ensure proper heat radiation, provide at least as much space around the display as shown below.

- * Make sure that the display is installed in a location where the temperature can be maintained between 0°C and 40°C.
- * Never attempt to tilt the display sideways or backward.
- * To prevent the power and other cables from being accidentally pulled, make sure that they run along the wall or through corners.
- * The display can be installed with either of its sides facing down.

When using the stand

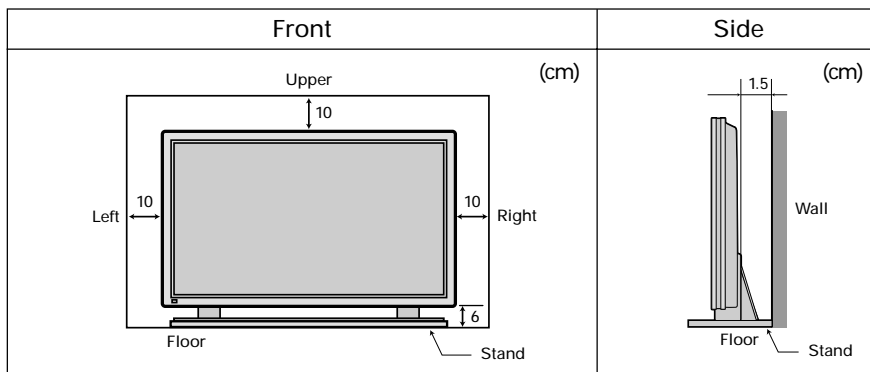

When using the wall-mounting unit (horizontal type)

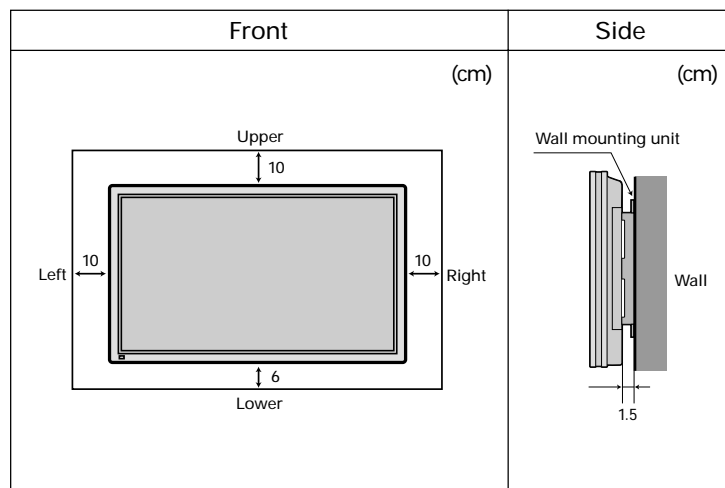

When using the wall-mounting unit (vertical type)

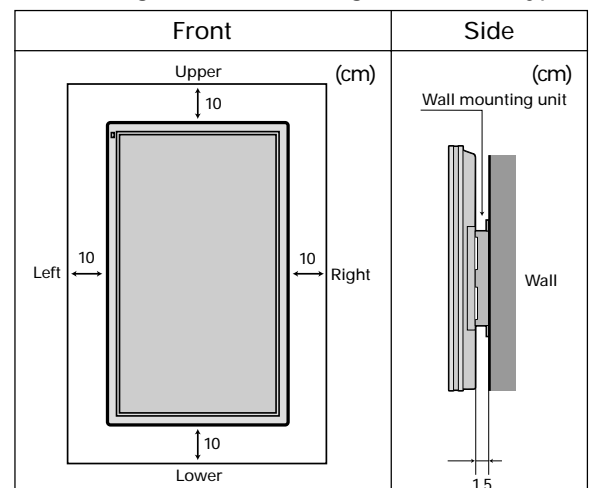

* When installing the display vertically, be sure to rotate the text.(Refer to OSD Rotate. See P.32) and setup vertical installation. (Refer to Installation. See P.38)

Note

The display is a highly precise piece of equipment and therefore must be packed properly before transportation. Be sure to use only those packing materials originally supplied with the display when repacking it.

Reference

See P. 40 for more information on options.

PART NAMES AND FUNCTIONS

Front

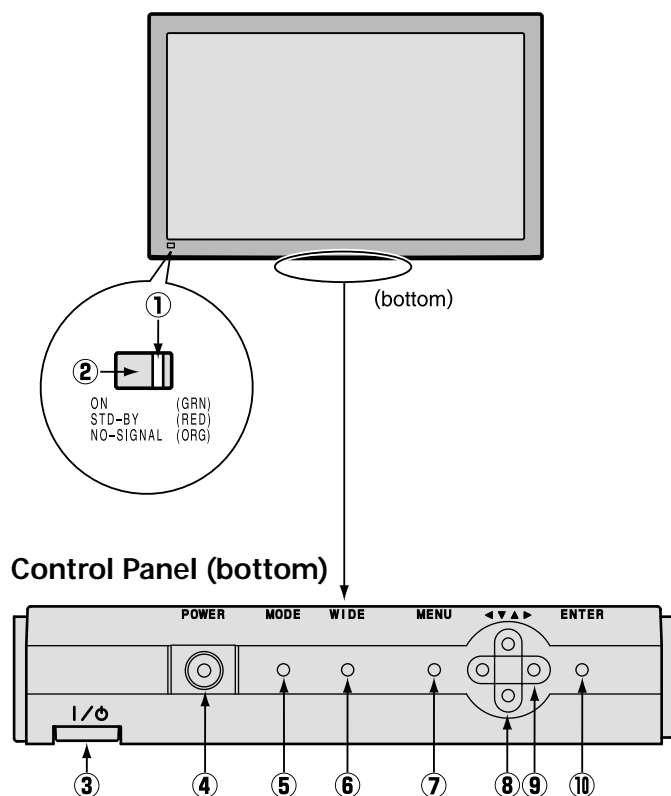

① Power indicator lamp

This lamp shows the state of the power supply.

Lit (red): Stand-by

Lit (green): Power ON

Lit (orange): Power saving (DPMS: Power saving function) mode ON

Flashing (red): Malfunction (Flashes differently depending on the type of malfunction. See P. 44 for more information.)

② Remote control signal receiver

Receives signals from the remote control.

③ Main power switch

When pressed, power indicator lamp ① lights red, and the power can be turned on or off by the remote controller.

When this switch is pressed again, the power is cut and power indicator lamp ① goes off.

④ Power button [POWER]

Turns the power ON or OFF.

⑤ Input mode selector button [MODE]

Switches between picture input modes.

⑥ Wide screen selector button [WIDE]

Switches the screen over to a desired wide screen.

⑦ Menu button [MENU]

Displays picture adjustment menus.

⑧ Adjustment buttons [▼ / ▲]

Adjust the volume.

The [▼ / ▲] buttons can also be used to scroll through the options when a menu is displayed.

⑨ Adjustment buttons [◀ / ▶]

The [◀ / ▶] buttons can also be used to scroll through options in a menu, or to change values.

⑩ Enter button [ENTER]

Press this button to finalize the selection of a desired option in a menu.

Warning

If the power indicator lamp flashes red, this signifies that the display has developed a problem. When this happens, be sure to remove the power plug from the receptacle and contact your dealer. Leaving the display power ON can result in fire or electric shock.

PART NAMES AND FUNCTIONS (Continued)

Bottom

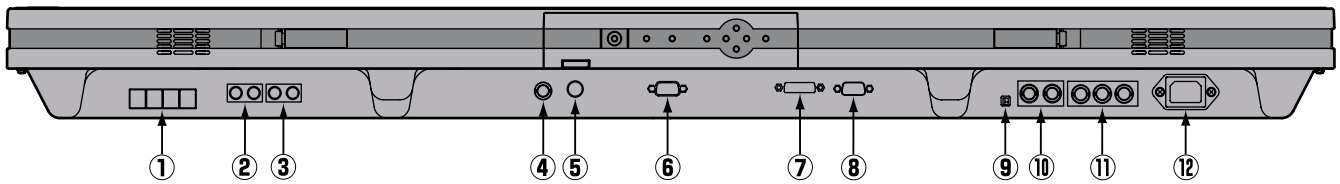

① **External speaker output terminal (EXT SP)**

Connect this terminal to the optionally available speaker. (Use a speaker with 4 to 16 Ω .)

*See the speaker instruction manual for more information.

② **Sound 1 input terminal (AUDIO 1 INPUT)**

Connect this terminal to the sound output terminal of your VCR, etc.

③ **Sound 2 input terminal (AUDIO 2 INPUT)**

Connect this terminal to the sound output terminal of your VCR, etc.

④ **Video input terminal (VIDEO INPUT)**

Connect this terminal to the video output terminal of your VCR or video disk player.

⑤ **S-video input terminal (S-VIDEO INPUT)**

Connect this terminal to the S-video output terminal of your VCR or video disk player.

⑥ **RS-232C terminal (RS-232C)**

This terminal is provided for you to control the display from the PC. Connect it to the RS-232C terminal on the PC.

When connecting a cable, attach a ferrite core to the cable. (See P. 12.)

⑦ **RGB 1 input terminal (RGB 1 INPUT/DVI-D)**

Connect this terminal to the PC's display (digital RGB) output terminal.

*The connection cable No.88741-8000 made by **molex Inc.** is recommended.

⑧ **RGB 2 input terminal (RGB 2 INPUT/mD-sub)**

Connect this terminal to the PC's display (analog RGB) output terminal or decoder (digital broadcast tuner, etc.) output terminal.

⑨ **RGB 3 synchronization switch (SYNC SW TTL/ANALOG (75 Ω))**

This switch is used to terminate horizontal (H) terminal and vertical (V) terminal, out of RGB3 input terminals, with 75 Ω .

TTL : Used when sending RGB signals from the PC to the RGB 3 terminal

ANALOG (75 Ω): Used when sending analog synchronization signals to the RGB 3 terminal

⑩+⑪ **RGB 3 input terminal (RGB 3 INPUT/BNC)**

Connect this terminal to the PC's display (analog RGB) output terminal or decoder (digital broadcast tuner, etc.) output terminal.

*When RGB3 input terminal is connected, Comp.video mode is not available. (See P. 33.)

⑪ **Component video input terminal (COMPONENT VIDEO INPUT)**

Connect this terminal to the component video output (color difference output) terminal of your HDTV unit or DVD player.

*When Comp.video input terminal is connected, RGB3 mode is not available. (See P. 33.)

⑫ **Power input terminal**

Connect this terminal to the power cable supplied with the display.

When connecting a cable, attach a ferrite core to the cable. (See P.12)

Description of Input Terminals

DVI-D terminal (RGB 1 INPUT/DVI-D)

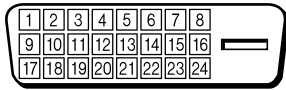

Pin No.	Signal	Pin No.	Signal	Pin No.	Signal
1	T.M.D.S. Data2-	9	T.M.D.S. Data1-	17	T.M.D.S. Data0-
2	T.M.D.S. Data2+	10	T.M.D.S. Data1+	18	T.M.D.S. Data0+
3	T.M.D.S. Data2 Shield	11	T.M.D.S. Data1 Shield	19	T.M.D.S. Data0 Shield
4	—	12	—	20	—
5	—	13	—	21	—
6	DDC Clock	14	+5V Power	22	T.M.D.S. Clock Shield
7	DDC Data	15	Ground(for +5V)	23	T.M.D.S. Clock +
8	—	16	Hot Plug Detect	24	T.M.D.S. Clock-

RGB2 input terminal (RGB2 INPUT/mD-sub)

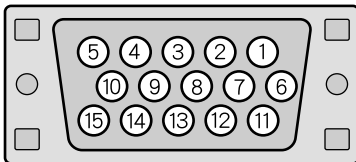

Pin No.	Input signal	Pin No.	Input signal
1	Red	9	—
2	Green	10	Ground
3	Blue	11	—
4	—	12	—
5	Ground	13	Horizontal synchronization
6	Ground	14	Vertical synchronization
7	Ground	15	—
8	Ground	Frame	Ground

RS-232C terminal (RS-232C)

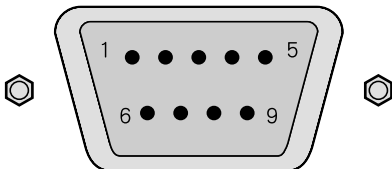

Pin No.	Signal
1	DCD (Data Carrier Detect)
2	RD (Received Data)
3	TD (Transmit Data)
4	DTR (Data Terminal ready)
5	GND (Ground)
6	DSR (Data Set Ready)
7	RTS (Request To send)
8	CTS (Clear To Send)
9	RI (Ring Indication)

PART NAMES AND FUNCTIONS (Continued)

Remote Control

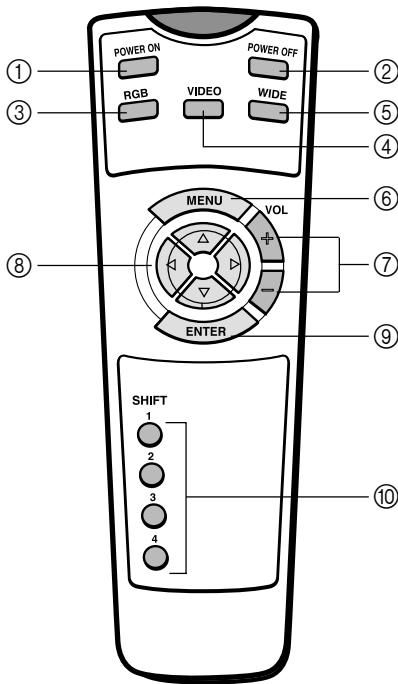

- ① **Power ON button [POWER ON]** → (See P. 14.)
Turns the power ON.
- ② **Power OFF button [POWER OFF]** → (See P. 14.)
Turns the power OFF.
- ③ **RGB input mode selector button [RGB]** → (See P. 15.)
Switches between RGB input modes.
- ④ **Video input mode selector button [VIDEO]** → (See P. 15.)
Switches between video input modes.
- ⑤ **Wide screen selector button [WIDE]** → (See P. 16-17.)
Switches the screen over to a desired wide screen.
- ⑥ **Menu button [MENU]** → (See P. 18-39.)
Use this button to display a desired menu for adjusting the picture.
- ⑦ **Volume adjustment buttons [VOL +/-]** → (See P. 14.)
Adjust the volume. Press the + button to increase the volume.
Press the - button to reduce the volume.
- ⑧ **Adjustment buttons [◀ / ▶ / ▲ / ▼]** → (See P. 18-39.)
Use these buttons to scroll through options in a menu and change values.
- ⑨ **Enter button [ENTER]** → (See P. 18-39.)
Press this button to finalize the selection of a desired menu or option within a menu.
- ⑩ **Display selector buttons [SHIFT 1-4]** → (See P. 36.)
When you use two or more displays, you can use these buttons to control up to four displays by assigning a unique number to each display.

PUTTING BATTERIES IN THE REMOTE CONTROL

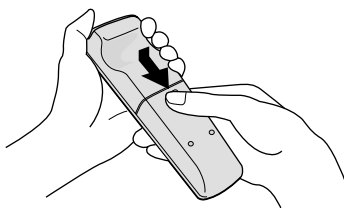

- ① To remove the cover, slide it outwards while pressing it down.

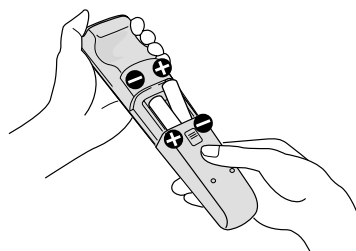

- ② Place two AA batteries in the remote control. Make sure that the batteries are properly oriented.

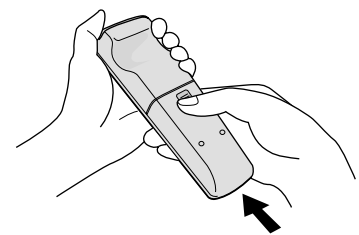

- ③ Close the cover until it snaps into place.

CAUTION: Be sure to use replacement batteries of the same type as the original ones.
When disposing of used batteries, please comply with governmental regulations or environmental public institution's rules that apply in your country/area.

Note

The remote control will not function properly if the batteries are dead. Be sure to replace them as needed.

USING THE REMOTE CONTROL

PRECAUTIONS

To prevent malfunction, be sure not to apply any form of severe shock to the remote control.

To prevent malfunction or deformation, be sure not to allow the remote control to become wet; also, keep it away from hot locations or heating equipment.

Be sure not to clean the remote control using a cloth dampened in any volatile solvent, such as benzene or thinner.

EFFECTIVE RANGE FOR THE REMOTE CONTROL

Point the remote control at the display's signal receiver when using it.

Make sure that there are no obstacles between the remote control and the display's signal receiver.

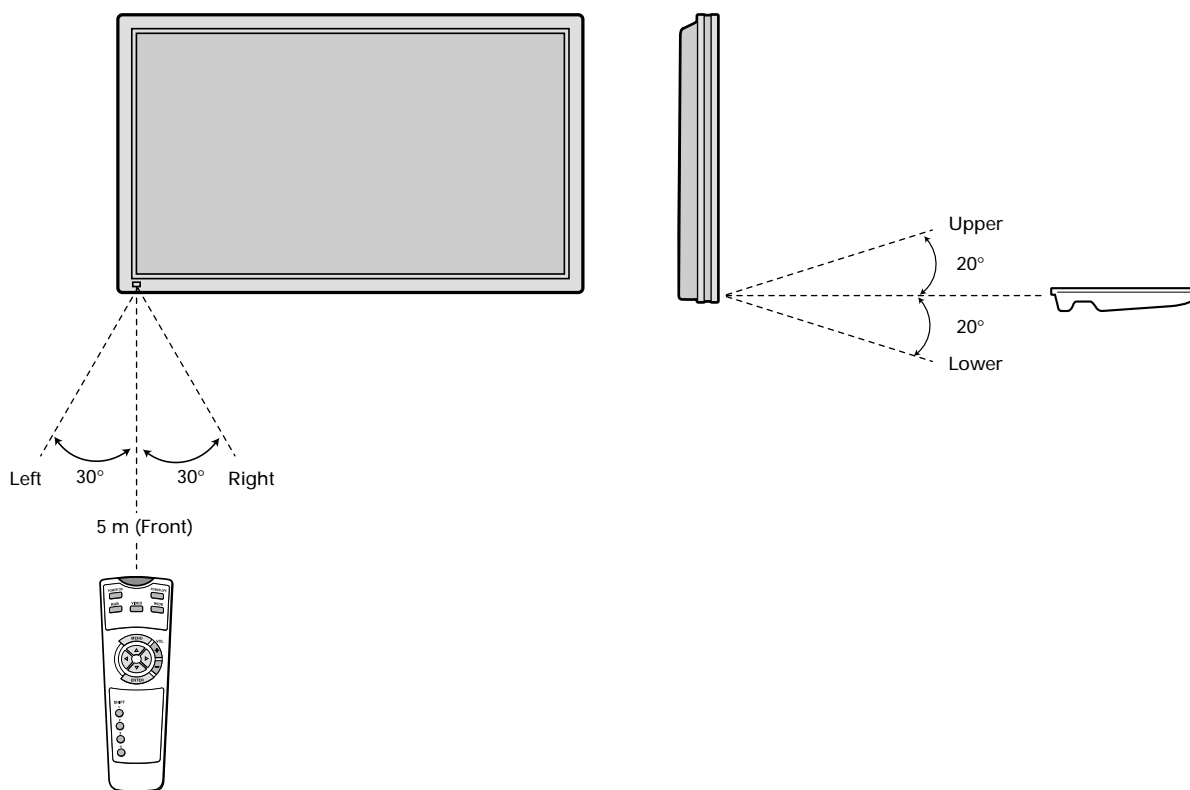

Information

The remote control may not function properly if you use a high-frequency fluorescent lamp. If you experience problems, move the lamp or use the remote control from a different position.

CONNECTING THE DISPLAY TO EXTERNAL EQUIPMENT

Be sure to turn OFF the power to the display and external equipment before making any connections.

No cables are supplied with the display for connection to external equipment. The type of cable to be used varies depending on the PC model. Contact your dealer for more information.

RECEPTACLE

Make sure that the power cable's grounding wire is grounded.

The display comes with a 3-prong power plug; one prong is connected to the grounding wire. If you have only a 2-hole receptacle, you will need to have it replaced. Contact your dealer for more information.

CONNECTING THE DISPLAY TO EXTERNAL EQUIPMENT

Carefully check the terminals for position and type before making any connections.

Loose connectors can result in picture or color problems. Make sure that all connectors are securely inserted into their terminals.

Terminal	Connector
VIDEO INPUT	BNC
S-VIDEO INPUT	S terminal
COMPONENT VIDEO INPUT	BNC x 3
RGB INPUT	mD-sub 15-pin , BNC x 5 , DVI-D
AUDIO INPUT	Pin jack
RS-232C	D-sub 9-pin

Ferrite cores

These ferrite cores are used to attenuate undesired signals.

Two ferrite cores

When connecting a cable to the power input terminal, RS-232C terminal, attach one of these ferrite cores to the cable near the terminal.

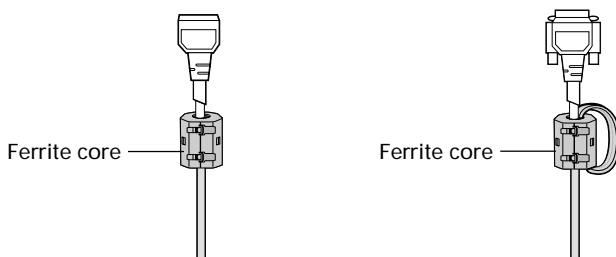

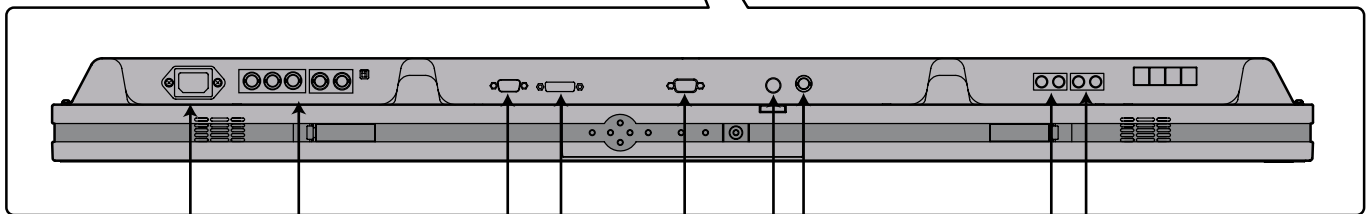
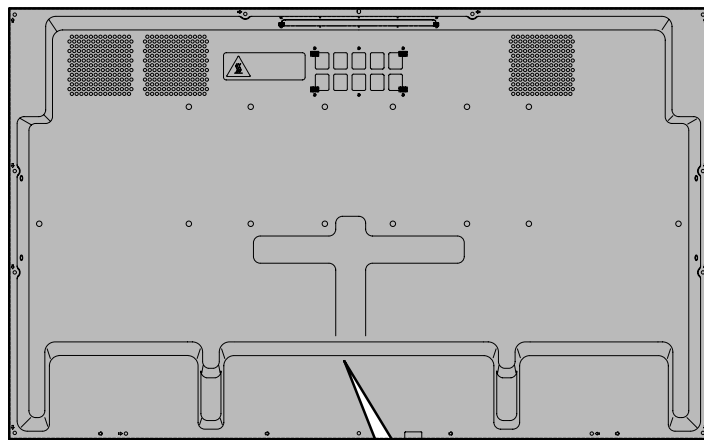

POWER INPUT COMPONENT VIDEO INPUT (color difference input) / RGB3 INPUT RGB2 INPUT (mD-sub) RGB1 INPUT (DVI-D) RS-232C S-VIDEO INPUT VIDEO INPUT AUDIO2 INPUT AUDIO1 INPUT

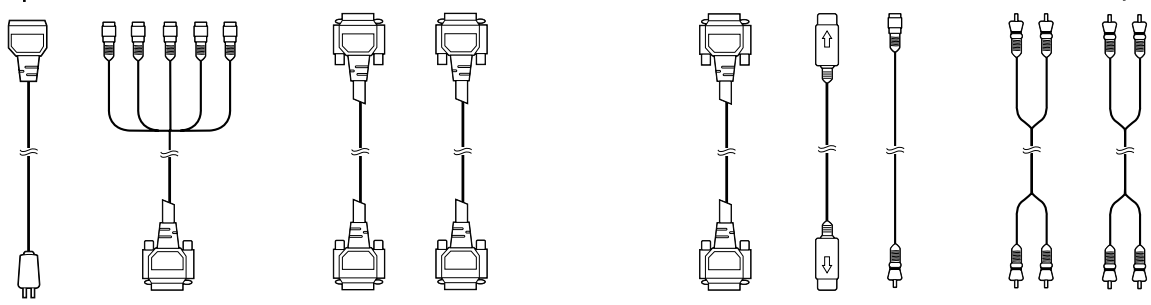

To receptacle To color difference output terminal / To display (analog RGB) output terminal To display (analog RGB) output terminal To display (digital RGB) output terminal To RS-232C output terminal To S-video output terminal To video output terminal To sound output terminal To sound output terminal

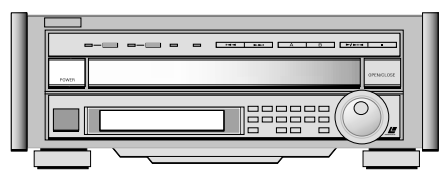

Connection to AV equipment

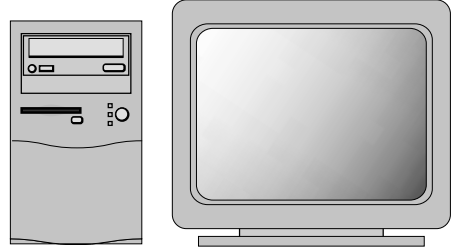

Connection to PC

BASIC OPERATIONS

TURNING ON THE POWER

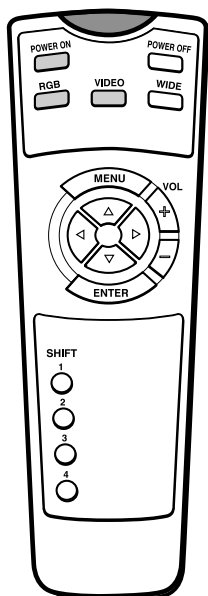



- 1** Press the main power switch at the bottom of the display.

When you do so, the main power turns ON.

- 2** Press  on the remote control.

When you do so, the power indicator lamp turns green.

- 3** Press  or  to select a desired input mode.

* You can also use the switches on the display's control panel to accomplish these steps.

TURNING OFF THE POWER

Press  when the power is ON.



The power indicator lamp turns red.

ADJUSTING THE VOLUME

Press  to increase the volume.

Press  to reduce the volume.

Any value between 0 and 40 can be selected.

* "No Audio" appears if you press  or  after you have selected "No Audio" for "Audio Input". (See P. 35.)

* Note that the volume level remains stored even when you turn OFF the power.

* As Audio Input is set at "No Audio" in the factory settings, the sound volume cannot be adjusted.



When the volume adjustment button is pressed

SELECTING INPUT MODE

VIDEO INPUT MODE

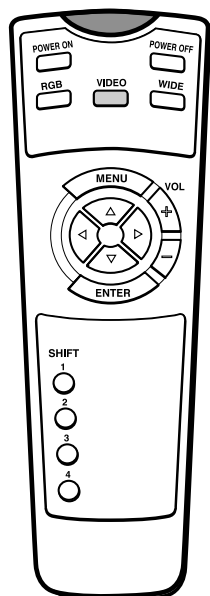

* You can also use the switches on the display's control panel to accomplish these steps.

1 Press to select a desired input mode.

Each time you press , a different input mode appears. The sequence is as follows:

 → Video → S-video → Comp.video

Video: Displays pictures from equipment connected to the Video terminal.

S-video: Displays pictures from equipment connected to the S-video terminal.

Comp.video: Displays pictures from equipment connected to the component video input terminal.

* You can switch between video input modes while you are in RGB input mode.

* When Comp.video input terminal is connected, RGB3 mode is not available. Setting is made in BNC Input mode.(See P.33.)



S-video mode

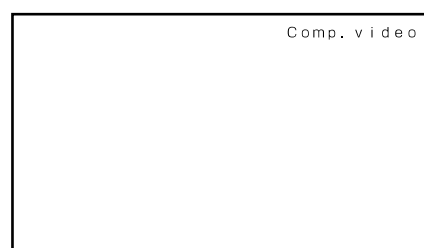

Comp.video mode

RGB INPUT MODE

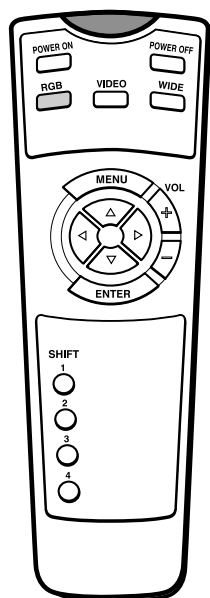

* You can also use the switches on the display's control panel to accomplish these steps.

1 Press to select a desired input mode.

Each time you press , a different input mode appears. The sequence is as follows:

 → RGB1 → RGB2 → RGB3

RGB1: Displays pictures from equipment connected to the RGB1 (DVI-D) terminal.

RGB2: Displays pictures from equipment connected to the RGB2 (mD-sub) terminal.

RGB3: Displays pictures from equipment connected to the RGB3 (BNC x5) terminal.

* You can switch between RGB input modes while you are in a video input mode.

* When RGB3 input terminal is connected, Comp.video mode is not available. Setting is made in BNC Input mode.(See P.33.)

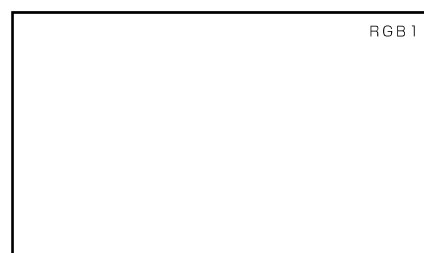

RGB1 mode



RGB2 mode

WATCHING PICTURES ON THE WIDE SCREEN

SWITCHING BETWEEN SCREEN SIZES

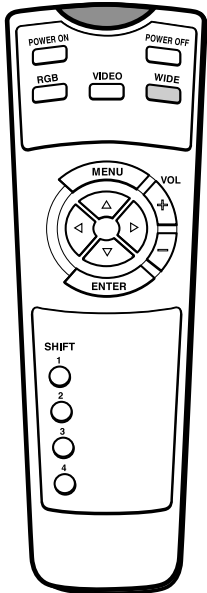

* You can also use the switches on the display's control panel to accomplish these steps.

1 Press **WIDE**.

The currently selected mode will appear.

2 Press **WIDE** to select a desired picture mode.

Each time you press **WIDE**, a different picture mode appears. The sequences used are as follows:

When you are in a Video or S-video input mode

→Normal→Auto→Wide1→Wide2
←Zoom2 ← Zoom1←

When you are in a Comp.video input mode

→Normal→Wide1→Wide2
←Zoom2 ← Zoom1←

When you are in an RGB input mode

→Normal→Wide→Zoom

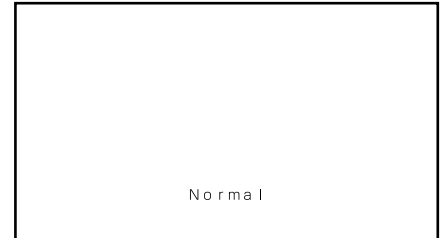

Normal mode



Wide1 mode

* Depending on the type of signal, some aspects may not be selected.

Note

- Displaying a picture in a Normal mode for extended periods of time may cause phosphor burn-in.
- A variety of picture modes are available with this display. Remember that if you select a mode with an aspect ratio (ratio of frame width to frame height) different from that of the TV program or video media, the pictures will appear differently than if you had selected a mode having the same aspect ratio.
- Showing a movie or similar premium event at a different aspect ratio from its original one at any event site, restaurant, or bar for profit-making purposes or for a public audience may constitute a copyright infringement.
For films, try to select a mode having the same aspect ratio as the original picture; this enables the director's original intentions to be preserved.

Reference

See P. 26–27 for how to adjust the picture size and position.

SCREEN SIZE

Normal

Displays pictures of normal size (i.e., a 4:3 aspect ratio).

Auto

The screen size changes automatically in accordance with the contents of image software you use.

Wide1

Displays natural-looking pictures of standard size on the wide screen.

Wide2/Wide

Ideal for displaying vertically extended pictures such as squeezed pictures and recorded HDTV programs.

Zoom1/Zoom

Enlarges horizontally extended pictures equally in all directions to maintain the aspect ratio constant.

Zoom2

Reduces the height of horizontally extended pictures with captions, without eliminating the caption. Only the height of pictures is reduced, not the height of the caption.

(Captions may not be easy to read, however, depending on the picture.)

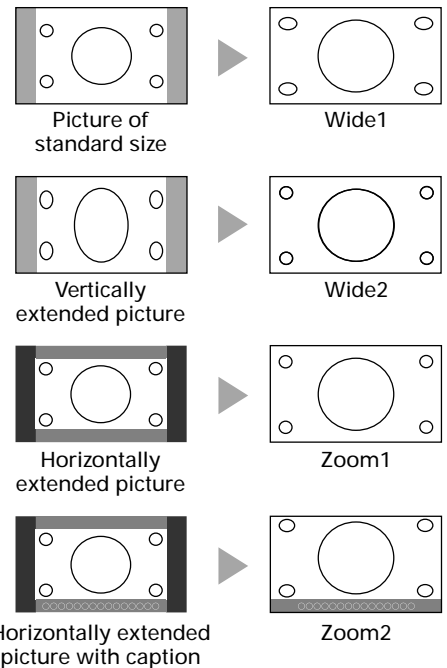

ASPECT RATIO

The following aspect ratios are available.

4:3 aspect ratio
(VHF/UHF broadcasting, BS broadcasting)

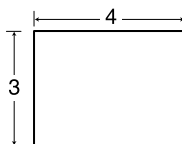

16:9 aspect ratio
(HDTV broadcasting)

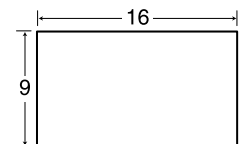

1.85:1 aspect ratio
(Vista Vision size)

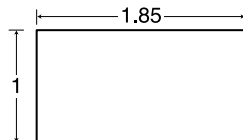

2.35:1 aspect ratio
(Cinema Vision size)

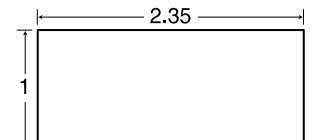



Information

You may find dark areas on top and at the bottom of the screen if you select one of the Zoom modes for media while using the Vista Vision or Cinema Vision size i.e., the sizes used frequently for picture software.

HOW TO USE MENUS



SELECTING OPTIONS IN A MENU

Use the [MODE] button on the display or  and  on the remote control to select a desired input mode.



1 Press .

The main menu screen will appear.

2 Press  or  to switch between sub-menus.

Each time you press  or , one of the available menus appears.

The corresponding menu screen will appear.

3 Press  or  to select an option for adjustment/setup.

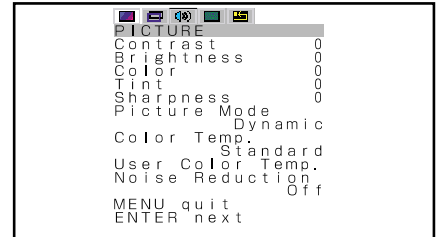

Ex.: "PICTURE" selected in the main menu screen

A total of five different menus (PICTURE, POSITION/SIZE, AUDIO, FEATURES, FACTORY DEFAULT) are available.

You can easily distinguish between these menus as shown below.

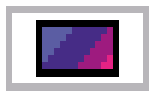

PICTURE



POSITION/SIZE





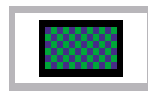

AUDIO

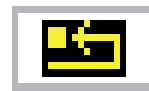

FEATURES



FACTORY DEFAULT

*Press , ,  or  to make adjustment/setup, and press  to store.

* Do not change input signals when any of the menus are displayed.



* Audio Input menu will not be displayed when "No Audio" is selected. (See P. 35.)

USING THE PICTURE MENU



When you finish selecting a desired option in the PICTURE menu screen, press .

At this time, the adjustment/setup screen for that option will appear.

You can use  or  to change the value for the option. Press  to store. (See P. 24–25.)

Changes you make will be stored only for the selected mode.

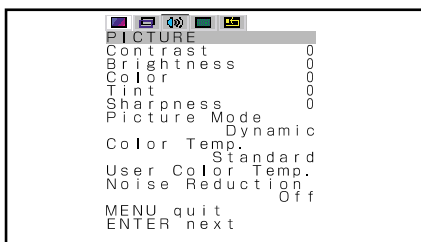

PICTURE Menu screen (Video Input Mode)

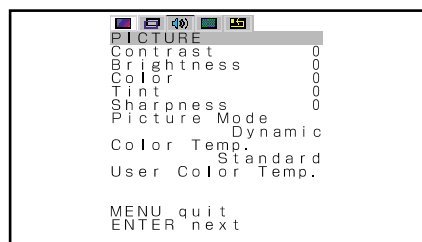

PICTURE Menu screen (RGB Input Mode)

Option	Function	Operation	Range
(1) Contrast	Adjusts picture contrast.	<ul style="list-style-type: none"> ⬆: Higher contrast ⬇: Lower contrast 	-30 to +30
(2) Brightness	Adjusts screen brightness.	<ul style="list-style-type: none"> ⬆: Brighter screen ⬇: Darker screen 	-60 to +60
(3) Color	Adjusts color darkness.	<ul style="list-style-type: none"> ⬆: Darker colors ⬇: Lighter colors 	-60 to +60
(4) Tint	Adjusts tint.	<ul style="list-style-type: none"> ⬆: More greenish colors ⬇: More purplish colors 	Video, S-video: -30 to +30 Comp.video, RGB-PC, Decoder : -60 to +60
(5) Sharpness	Adjusts picture sharpness.	<ul style="list-style-type: none"> ⬆: Sharper pictures ⬇: Less sharp pictures 	Video, S-video, Comp.video, Decoder : -16 to +16 RGB-PC : -4 to +4
(6) Picture Mode	Can set up the picture mode.	Use ⬆ or ⬇ for switching.	Dynamic/Fine/Real1/Real2/Static
(7) Color Temp.	Adjusts color temperature.	Use ⬆ or ⬇ for switching.	Warm/Standard/Cool/User
(8) User Color Temp.	Can set up when User is selected in Color Temp.	Press ⬆ or ⬇ to select Red, Green or Blue and press ⬆ or ⬇ to make adjustment.	0 to 255 for each of Red, Green and Blue
(9) Noise Reduction (for Video, S-video, Comp.video)	Sets up noise reduction.	Use ⬆ or ⬇ for switching.	Off/Min./Std./Max.

USING THE POSITION/SIZE MENU



When you finish selecting a desired option in the POSITION/SIZE menu screen, press .

When you do so, the adjustment screen for that option appears.

Press ⬆ or ⬇ to select option and press ⬆ or ⬇ to make adjustment. Press to store. (See P. 26–27.)

Changes you make will be stored only for the selected mode.

*You cannot adjust screen size in RGB1 (DVI-D) mode.

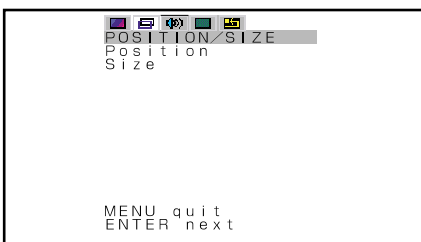

POSITION/SIZE Menu screen

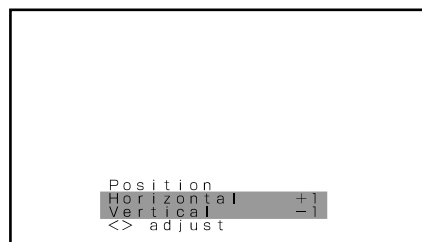

"Position" adjustment screen

Option	Function	Operation	Range
(1) Position	Adjusts screen position.		Video, S-video Horizontal: -30 to +30 Vertical Zoom: -15 to +15 Others: -7 to +7 Comp.video: -16 to +16 1080I,720P: -32 to +32 RGB-PC: -150 to +150 Decoder: -16 to +16 1080I,720P: -32 to +32
Horizontal	Adjusts horizontal position.	<ul style="list-style-type: none"> ⬆: Moves screen to the right. ⬇: Moves screen to the left. 	
Vertical	Adjusts vertical position.	<ul style="list-style-type: none"> ⬆: Moves screen up. ⬇: Moves screen down. 	
(2) Size	Adjusts screen size.		Video, S-video: -7 to +7 Comp.video: -4 to +4 RGB-PC: -25 to +50 Decoder: -4 to +4
Width	Adjusts width.	<ul style="list-style-type: none"> ⬆: Increases width. ⬇: Reduces width. 	
Height	Adjusts height.	<ul style="list-style-type: none"> ⬆: Increases height. ⬇: Reduces height. 	

HOW TO USE MENUS (Continued)

USING THE AUDIO MENU



When you finish selecting a desired option in the AUDIO menu screen, press .

When you do so, the adjustment screen for that option appears.

Press or to select option and press or to make adjustment. Press to store. (See P. 28–29.)

The adjustments you make will be stored for each audio input terminal.

*Audio Input menu will not be displayed when "No Audio" is selected. (See P. 35.)



AUDIO Menu screen

Option	Function	Operation	Range
(1) Treble	Adjusts treble.	: Stronger treble : Weaker treble	-6 to +6
(2) Bass	Adjusts bass.	: Stronger bass : Weaker bass	-6 to +6
(3) Balance	Adjusts volume balance.	: Higher volume from right-hand speaker : Higher volume from left-hand speaker	-10 to +10

USING THE FEATURES MENUS



- FEATURES setup screen has 5 options of Adjustment, Function, On Screen Menu, Input Terminal and Others.

- Options with "" on the right

When you select an option with "", press . The adjustment/setup screen for that option appears. (See P. 30–38.)

You can use or on this screen to make selections or changes. Press to store.

- Options with no "" on the right

When you select an option with no "", press or to make selections or changes. Press to store. (See P. 30–38.)

FEATURES Menu

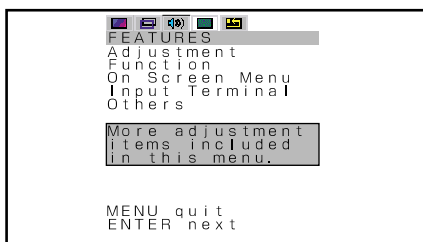

FEATURES Menu screen (Comp.video Input Mode)

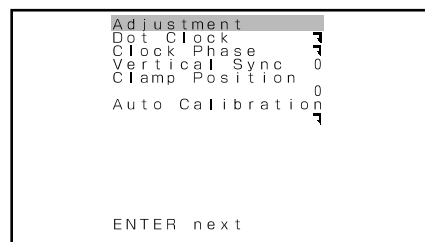

Adjustment Menu screen

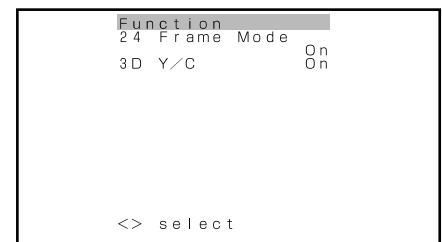

Function Menu screen

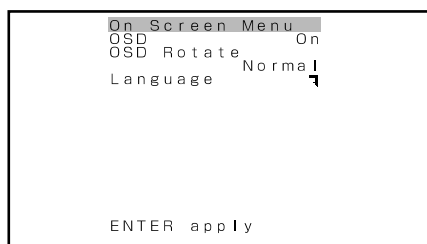

On Screen Menu screen

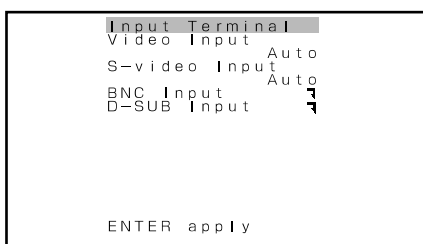

Input Terminal Menu screen

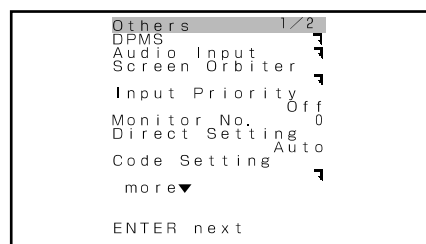

Others(1/2) Menu screen

Adjustment Menu (See P. 30-31.)

Option	Function	Operation	Range
(1) Dot Clock (for RGB2, RGB3)	Adjusts the dot clock.	Eliminates blur when the optimum value is selected with or .	-60 to +60
(2) Clock Phase (for RGB2, RGB3)	Adjusts clock phase.	Eliminates blur when the optimum value is selected with or .	Auto/Manual (Can adjust 1 to 32 for Manual)
(3) Vertical Sync (for RGB2, RGB3)	Corrects vertical synchronization signal.	Use or to select the optimum value for eliminating flicker.	-1 to +1
(4) Clamp Position (for Comp.video, RGB2, RGB3)	Adjusts clamp pulse phase.	Use or for switching.	-8 to 8
(5) Auto Calibration (for RGB2, RGB3)	Selects the optimum dynamic range of images.	Select Execute and use or to select an option.	Execute Yes/No

Function Menu(See P. 30,32.)













Option	Function	Operation	Range
(1) 24 Frame Mode (for Video, S-video, Comp.video)	Displays the optimum movie pictures.	Use or for switching.	On (Movie) / Off (Normal)
(2) 3D Y/C (for Video(3.58NTSC))	Selects whether to enable the 3D Y/C circuit.	Use or for switching.	On (3D Y/C circuit) / Off (3-line)

On Screen Menu(See P. 30,32)

Option	Function	Operation	Range
(1) OSD	Selects whether to display information other than menus.	Use or for switching.	On (displayed) / Off (not displayed)
(2) OSD Rotate	Rotates on-screen text.	Use or for switching.	-90 Deg. (counterclockwise)/ Normal/ +90 Deg. (clockwise)
(3) Language	Selects language used for menus.	Display the "Language" selection screen and use or to select a language.	English Deutsch (German) Español (Spanish) Français (French) Italiano (Italian) Português (Portuguese)

HOW TO USE MENUS (Continued)

Input Terminal Menu(See P. 30,33–34.)

Option	Function	Operation	Range
(1) Video Input (for Video)	Selects video mode.	Use  or  for switching.	Auto/NTSC/PAL/SECAM/ PAL60/N-PAL/M-PAL/ 4.43NTSC
(2) S-video Input (for S-video)	Selects video mode.	Use  or  for switching.	Auto/NTSC/PAL/SECAM/ PAL60/N-PAL/M-PAL/ 4.43NTSC
(3) BNC Input	Selects BNC Input signal.	Display BNC Input screen and press  or  to select an option. Use  or  for switching. Select Comp.video or Decoder by Function to set up Mask.	Function Comp.video/RGB-PC/ Decoder Mask Off/5/10/15 (dot)
(4) D-SUB Input	Selects D-SUB Input signal.	Display D-SUB Input screen and press  or  to select an option. Use  or  for switching. Select Decoder by Function to set up Mask.	Function RGB-PC/Decoder Mask Off/5/10/15 (dot)

Others Menu(See P. 30,34–38.)



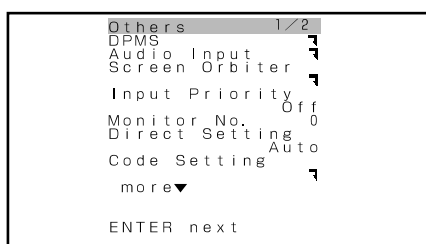



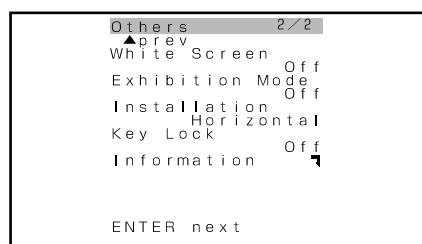





Others Menu screen is divided into the following two screens.



















Others(1/2) Menu screen



Others(2/2) Menu screen

Option	Function	Operation	Range
(1) DPMS	Specifies time before DPMS starts. Can specify the background color when specifying time.	Display DPMS screen and press  or  to select an option. Use  or  for switching. Can specify background by setting time to other than Off.	Time Off (disabled)/1 min./ 15 min./45 min./60 min. Background Black/White
(2) Audio Input	Selects audio input terminal.	Display the “Audio Input” adjustment screen and use  or  to select an option. Use  or  to switch between available choices for the selected option.	No Audio/Audio 1/Audio 2
(3) Screen Orbiter (for RGB)	Sets up screen orbiter.	Display the “Screen Orbiter” adjustment screen and use  or  to select an option. Use  or  to switch between available choices for the selected option.	Mode/Time Off (disabled) Time (every 1 hr) Mode (every time mode is switched) Moving area Min.(moves in small range) Std.(moves in moderate range) Max. (moves in wide range)

Option	Function	Operation	Range
(4) Input Priority	Specifies input mode of highest priority.	Use  or  for switching.	Off/RGB2/RGB3/Video/S-video/Comp.video
(5) Monitor No.	Selects display number.	Use  or  for switching.	0 (no setup) 1/2/3/4
(6) Direct Setting (for RGB)	Selects input signal.	Use  or  for switching.	RGB1: Auto/VGA/WVGA/XGA/WXGA RGB2, RGB3: Auto/VGA/WVGA/480P/XGA/WXGA/SXGA/SXGA+
(7) Code Setting (for RGB2, RGB3)	Specifies and displays type of input signal directly.	Display Code Setting screen and press  or  to select an option. Select Manual to set up Parameter.	Auto/Manual
(8) White Screen	Sets up to display white over the entire screen.	Use  or  for switching.	On /Off(disabled)
(9) Exhibition Mode	Sets up Exhibition mode.	Use  or  for switching.	On (Exhibition mode)/ Off(disabled)
(10) Installation	Sets up whether horizontal or vertical installation.	Use  or  for switching.	Horizontal/Vertical
(11) Key Lock	Locks the main unit button.	Use  or  for switching.	On (Key Lock)/ Off(disabled)
(12) Information	Displays system operation status.	Display the "Information" screen.	Display only

USING THE FACTORY DEFAULT MENU

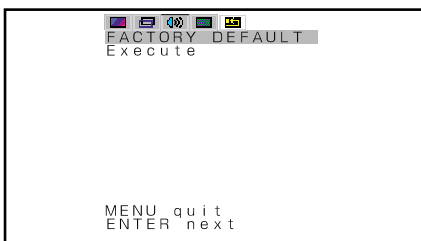

- Select **FACTORY DEFAULT** and execute to restore the adjustment/setting made in the MENU to factory settings. (See P. 39.)

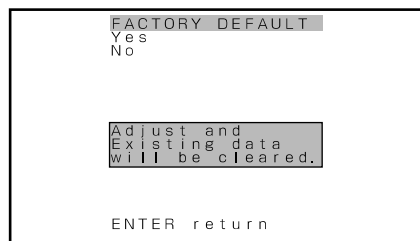

FACTORY DEFAULT Menu screen



Yes/No selection screen

Option	Function	Operation	Range
FACTORY DEFAULT	Restores the adjustment/setting made in the MENU to factory settings.	Select Execute and use  or  to select an option.	Yes/No

ADJUSTING PICTURES (PICTURE MENU)

BASIC OPERATIONS [EX.: ADJUSTING TINT (Tint)]

You can make changes to all picture adjustment options in the PICTURE Menu.

The changes you make will be stored for a selected input mode. Therefore, you need to select a desired input mode before making any changes.

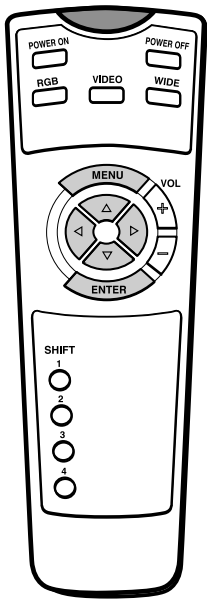

* You can also use the switches on the display's control panel to accomplish these steps.

1 Press .

The main menu screen will appear.

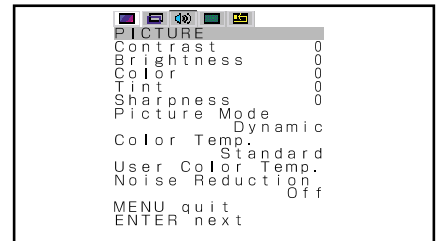

"PICTURE" selected in the main menu screen

2 Press or to select "PICTURE".

Each time you press or , one of the available menus appears in the following sequence:

PICTURE ↔ POSITION/SIZE ↔ AUDIO ↔ FEATURES ↔ FACTORY DEFAULT

The PICTURE Menu screen will appear.

3 Press or to select "Tint".

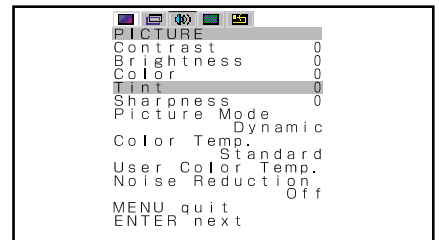

"Tint" selected in the PICTURE Menu screen (Video Input Mode)

4 Press .

The "Tint" adjustment screen will appear.

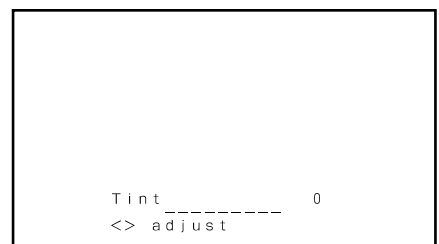

"Tint" adjustment screen

5 Press or to change tint values.

: More greenish colors

: More purplish colors

6 Press to store.

Press when you finish.

* Repeat steps 3, 4, 5, and 6 when you wish to make changes to other options.

* On-screen information disappears if you do not take any action for about 60 seconds.

* The following abbreviations used in this document represent input modes in which you can make adjustments:

[V]: Video mode, [S]: S-video mode, [C]: Comp.video mode, [R]: RGB mode



• Adjusting Contrast (Contrast)

V S C R

Any value between -30 and +30 can be selected.

⬆️: Higher contrast

⬇️: Lower contrast

Press **ENTER** to store.

• Adjusting Screen Brightness (Brightness)

V S C R

Any value between -60 and +60 can be selected.

⬆️: Brighter screen

⬇️: Darker screen

Press **ENTER** to store.

• Adjusting Color Darkness (Color)

V S C R

Any value between -60 and +60 can be selected.

⬆️: Darker colors

⬇️: Lighter colors

Press **ENTER** to store.

• Adjusting Tint (Tint)

V S C R

Any value between -30 and +30 for [V S], and -60 and +60 for [C R] can be selected.

⬆️: More greenish colors

⬇️: More purplish colors

Press **ENTER** to store.

• Adjusting picture Sharpness (Sharpness)

V S C R

Any value between -16 and +16 for [V S] [C R] (Decoder), and -4 and +4 for [R] (RGB-PC), can be selected.

⬆️: Sharper pictures

⬇️: Less sharp pictures

Press **ENTER** to store.

• Setting Picture Mode (Picture Mode)

V S C R

Can set up the picture mode.

Each time you press ⬆️ or ⬇️, one of the available choices appears in the following sequence:

➔ Dynamic ↔ Fine ↔ Real1 ↔ Real2 ↔ Static ←

Dinamic: Suitable for watching a normal motion picture. (Standard)

Fine: Suitable for watching a dark picture such as movie.

Real 1: Makes a strong contrast picture.

Real 2: Makes a bright color picture.

Static: Suitable for watching a still picture.

Press **ENTER** to store.

*Select Dinamic, Fine, Real 1, Real 2 or Static to suit your taste.

• Adjusting Color Temperature (Color Temp.)

V S C R

Use ⬆️ or ⬇️ to specify a desired color temperature. Each time you press ⬆️ or ⬇️, one of the available choices appears in the following sequence:

➔ Warm ↔ Standard ↔ Cool ↔ User ←

Warm: More reddish colors

Standard: Standard color temperature

Cool: More bluish colors

User: User Color Temp. setup

Press **ENTER** to store.

• Setting User Color Temp. (User Color Temp.)

V S C R

Can set up when User is selected in Color Temp.

Press ⬆️ or ⬇️ to select Red, Green or Blue and press ⬆️ or ⬇️ to make adjustment in the range of 0 to 255.

Press **ENTER** to store.

* Color Temp. setup is switched to User. The initial value of User Color Temp. is adjusted individually at the factory.

• Setting Noise Reduction (Noise Reduction)

V S C

Can select the noise reduction setting corresponding to the noise level of the input signal.

Each time you press ⬆️ or ⬇️, one of the available choices appears in the following sequence:

➔ Off ↔ Min. ↔ Std. ↔ Max. ←

Off: Noise reduction does not function.

Min.: Weak setting

Std.: Standard setting

Max.: Strong setting

Press **ENTER** to store.

*Some type of signal can not be selected.

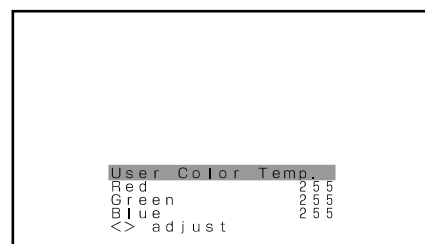

User Color Temp. adjustment screen

ADJUSTING SCREEN POSITION AND SIZE (POSITION/SIZE MENU)

BASIC OPERATION [EX.: ADJUSTING HORIZONTAL DIRECTION OF SCREEN POSITION]

You can make changes to all screen adjustment options in the POSITION/SIZE Menu.

The changes you make will be stored for the selected input mode. Therefore, you need to select a desired input mode before making any changes.

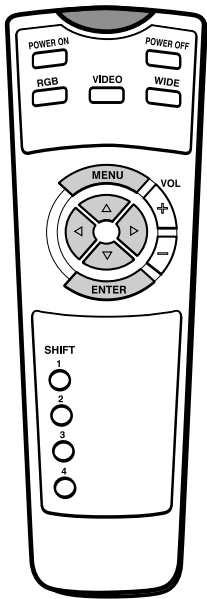



* You can also use the switches on the display's control panel to accomplish these steps.

1 Press .

The main menu screen will appear.





2 Press  or  to select "POSITION/SIZE".

Each time you press  or , one of the available menus appears in the following sequence:

PICTURE \longleftrightarrow POSITION/SIZE \longleftrightarrow AUDIO \longleftrightarrow FEATURES \longleftrightarrow FACTORY DEFAULT



The POSITION/SIZE Menu screen will appear.

"POSITION/SIZE" selected from the main menu screen

3 Press  or  to select "Position".

4 Press .

The "Position" adjustment screen will appear.

5 Press  or  to select "Horizontal" values of screen position.

6 Press .

The "Horizontal" adjustment screen will appear.

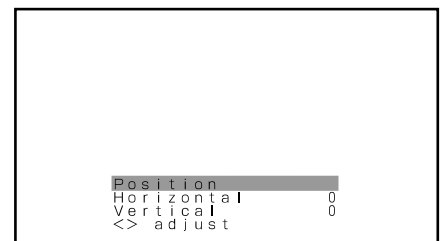

"Position" adjustment screen

7 Press  or  to change horizontal values.

: Moves screen to the right.

: Moves screen to the left.

8 Press  to store.

Press  when you finish.

* Repeat steps 3 to 8 when you wish to make changes to other options.



Adjusting Screen Position (Position)

V S C R

Horizontal position (Horizontal)

➤: Moves screen to the right.

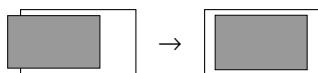

➤: Moves screen to the left.

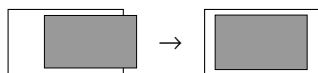

Vertical position (Vertical)

➤: Moves screen up.

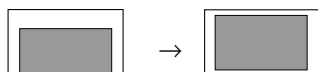

➤: Moves screen down.

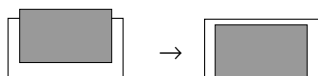

Press  to store.

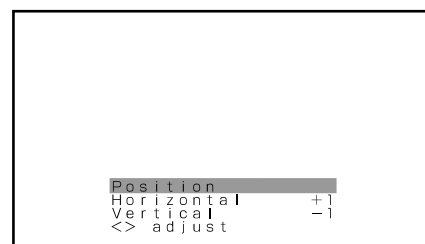

"Position" adjustment screen

Adjusting Screen Size (Size)

V S C R

Screen width (Width)

➤: Increases width.

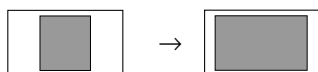

➤: Reduces width.

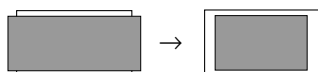

Screen height (Height)

➤: Increases height.

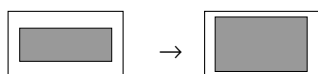

➤: Reduces height.

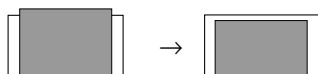

Press  to store.

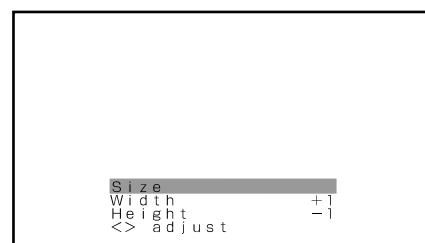

"Size" adjustment screen





*You cannot adjust screen size in RGB1 (DVI-D) mode.

Setting Range

	Video, S-video mode	Comp.video mode	RGB mode
Position	Horizontal: -30 to +30 Vertical Zoom: -15 to +15 Others: -7 to +7	-16 to +16 -32 to +32 (for1080I,720P)	RGB-PC: -150 to +150 Decoder: -16 to +16 -32 to +32 (for1080I,720P)
Size	-7 to +7	-4 to +4	RGB-PC: -25 to +50 Decoder: -4 to +4

* On-screen information disappears if you do not take any action for about 60 seconds.

* The following abbreviations used in this document represent input modes in which you can make adjustments:

: Video mode, : S-video mode, : Comp.video mode, : RGB mode

ADJUSTING AUDIO (AUDIO MENU)

BASIC OPERATION [EX.: ADJUSTING VOLUME BALANCE (Balance)]

You can make changes to all sound adjustment options in the AUDIO Menu.

The changes you make will be stored for the selected input mode. Therefore, you need to select a desired input mode before making any changes.

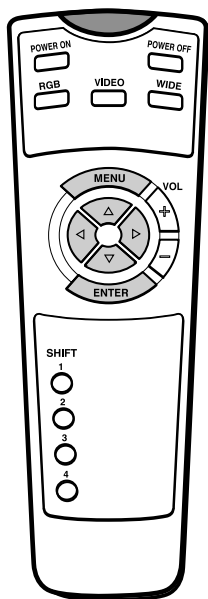

* You can also use the switches on the display's control panel to accomplish these steps.

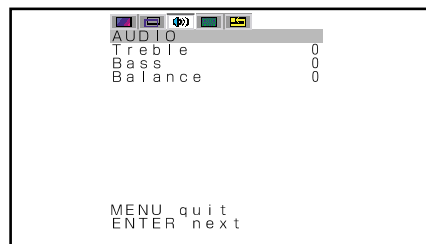

1 Press .

The main menu screen will appear.





"AUDIO" selected in the main menu screen

2 Press  or  to select "AUDIO".

Each time you press  or , one of the available menus appears in the following sequence:

PICTURE ↔ POSITION/SIZE ↔ AUDIO ↔ FEATURES ↔ FACTORY DEFAULT

The AUDIO Menu screen will appear.

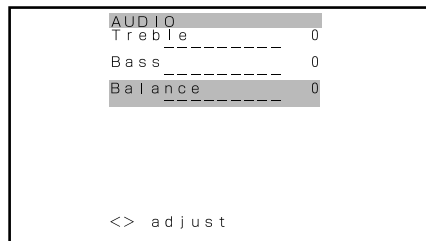

3 Press  or  to select "Balance".



"Balance" selected in the AUDIO Menu screen

4 Press .

The "Balance" adjustment screen will appear.

5 Press  or  to adjust the balance.

: Higher volume from the right-hand speaker

: Higher volume from the left-hand speaker

6 Press  to store.

Press  when you finish.

* Repeat steps 3 to 6 when you wish to make changes to other options.

* Audio Input menu will not be displayed when "No Audio" is selected. (See P. 35.)



Adjusting Treble (Treble)

Any value between -6 and +6 can be selected.

▶: Stronger treble

◀: Weaker treble

Adjusting Bass (Bass)

Any value between -6 and +6 can be selected.

▶: Stronger bass

◀: Weaker bass

Adjusting Volume Balance (Balance)

Any value between -10 and +10 can be selected.

▶: Higher volume from the right-hand speaker

◀: Higher volume from the left-hand speaker

Each audio input

Each audio input

Each audio input

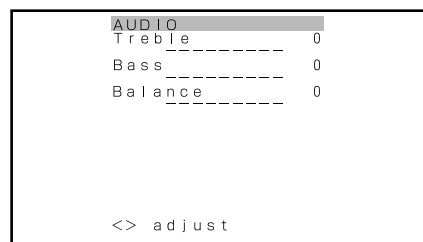

AUDIO Menu screen

* On-screen information disappears if you do not take any action for about 60 seconds.

* The following abbreviations used in this document represent input modes in which you can make adjustments:

▶: Video mode, ◀: S-video mode, ◻: Comp.video mode, ◻: RGB mode

OTHER ADJUSTMENTS (FEATURES MENU)

BASIC OPERATION [EX.: SELECTING LANGUAGE (Language)]

You can make the following changes in the FEATURES Menu.

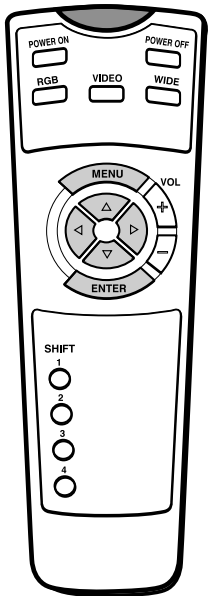

* You can also use the switches on the display's control panel to accomplish these steps.

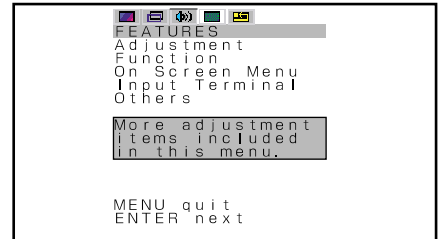

1 Press .

The main menu screen will appear.



"FEATURES" selected in the main menu screen

2 Press  or  to select "FEATURES".

Each time you press  or , one of the available menus appears in the following sequence:

PICTURE ↔ POSITION/SIZE ↔ AUDIO ↔ FEATURES ↔ FACTORY DEFAULT

The FEATURES Menu screen will appear.

3 Press  or  to select "On Screen Menu".

- Select a desired option for adjustment/setup from Adjustment, Function, On Screen Menu, Input Terminal and Others.

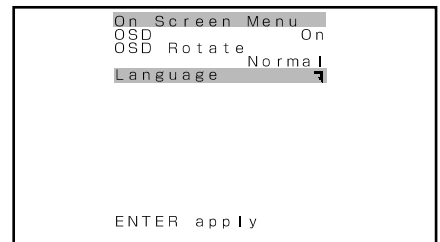

On Screen Menu screen

4 Press .

- On Screen Menu appears.



5 Press  or  to select "Language".

6 Press .

The "Language" selection screen will appear.



"Language" selection screen

7 Press  or  to select the language.

8 Press .

The menu is displayed in the selected language.

Press  when you finish.

* Repeat steps 3 to 8 when you wish to make changes to other options.

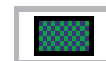

• **FEATURES setup screen has the following 5 options.**

- Adjustment : Can make a fine adjustment of pictures such as Dot Clock, Clamp Position.
- Function : Can make a function setting such as 24 Frame Mode, 3D Y/C. (See P. 32.)
- On Screen Menu : Can make a display setting such as OSD, Language. (See P. 32.)
- Input Terminal : Can make an input terminal setting such as Video Input. (See P. 33 - 34.)
- Others : Can make other settings. (See P. 34 - 38.)

ADJUSTMENT

• **Adjusting Dot Clock (Dot Clock)** [R]

You may find that pictures blur, depending on the clock frequency of your PC's processor.

If you experience blurring, you can obtain a clearer picture by adjusting the "Dot Clock".

Use or to select a value between -60 and +60.

Press to store.

• **Adjusting Clock Phase (Clock Phase)** [R]

You may find that pictures blur, depending on the clock phase of your PC's processor. If you experience blurring, you can obtain a clearer picture by adjusting the "Clock Phase".

Use or to select "Auto" or "Manual".

Auto: Makes automatic adjustment.

Manual: Does not make automatic adjustment.

Use or to specify a value between 1 and 32.

Press to store.

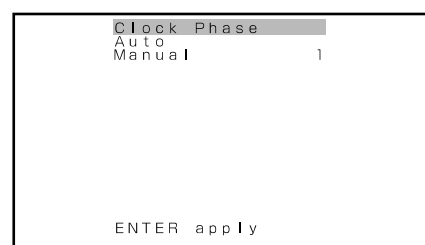

When selecting Manual by Clock Phase

• **Eliminating Flicker (Vertical Sync)** [R]

Corrects the vertical synchronization signal timing to eliminate vertical flicker.

Use or to specify a value between -1 and +1.

Press to store.

*Some type of signal can not be selected.

• **Adjusting Clamp Position (Clamp Position)** [C] [R]

Adjusts clamp pulse in accordance with the input signal received from connected equipment.

Use or to specify a value between -8 and 8.

Press to store.

• **Selecting the Optimum Dynamic Range of Images (Auto Calibration)** [R]

Receives a white screen signal and adjusts the dynamic range of images to the optimum.

(1) Select Auto Calibration and press .

Auto Calibration screen appears.

(2) Select Execute and press .

Press or to select Yes or No.

Yes: Stores the data of Auto Calibration.

No: Disables the execution result of Auto Calibration.

(3) Press to execute.

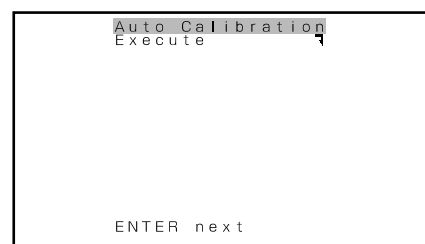

"Auto Calibration" setting screen

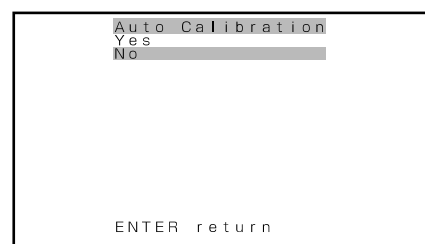

"Yes/No" selection screen

* On-screen information disappears if you do not take any action for about 60 seconds.

* The following abbreviations used in this document represent input modes in which you can make adjustments:



[V]: Video mode, [S]: S-video mode, [C]: Comp.video mode, [R]: RGB mode

OTHER ADJUSTMENTS (FEATURES MENU)(Continued)

FUNCTION

• Displaying the optimum movie pictures (24 Frame Mode) [V] [S] [C]

Can make the optimum display of 24 frames/second signals such as movie pictures.

Each time you press  or , one of the available choices appears in the following sequence:

On  Off

On : Displays the optimum movie pictures.



Off : Displays normal pictures.

Press  to store.

*Some type of signal can not be selected.

• Setting 3D Y/C Circuit (3D Y/C) [V]

Selects whether to use the 3D Y/C circuit.

Each time you press  or , one of the available choices appears in the following sequence:

On  Off

On : Enables the 3D Y/C circuit.

You can make this selection only for 3.58NTSC signal. You can make the optimum display for the movie film signals.

Off : Enables 3-line.



Press  to store.

ON SCREEN MENU

• Setting Display Information (OSD)

All modes

You can use this option to select whether to display information other than menus. (Error messages are displayed regardless of what choice you make for this option.)

Each time you press  or , one of the available choices appears in the following sequence:

On  Off

On : Displays all information.

Off : Displays only menus and error messages.



Press  to store.

• When rotating text (for installing the display with one of its sides facing down)

Rotating text (OSD Rotate)

All modes

You can use this option to rotate the text.

Each time you press  or , one of the available choices appears in the following sequence:

 -90 Deg.  Normal  +90 Deg. 

-90 Deg. : Displays text from left to right when the display is installed with the power indicator lamp at the top.

Normal : Displays text normally.

+90 Deg. : Displays text from left to right when the display is installed with the power indicator lamp at the bottom.

Press  to store.

• Selecting Language (Language)

All modes

You can use this option to select the language displayed on the screen.

(1) Select "Language" and press .

The "Language" selection screen will appear.

(2) Press  or  to select your desired language.

English

Deutsch (German)

Español (Spanish)

Français (French)

Italiano (Italian)

Português (Portuguese)

(3) Press .

The menu is displayed in the selected language.





"Language" selection screen

INPUT TERMINAL

• Selecting Video Mode (Video Input) [V]

You can use this option to select the desired video mode of pictures it will receive to the Video Input terminal.

Each time you press  or , one of the available modes appears in the following sequence:

→Auto↔NTSC↔PAL↔SECAM↔PAL60↔N-PAL↔M-PAL↔4.43NTSC←



Auto: Automatically selects NTSC, PAL and SECAM.

Other than Auto: You need to select a system appropriate to the input signal.

Press  to store.

• Selecting Video Mode (S-video Input) [S]

You can use this option to select the desired video mode of pictures it will receive to S-video Input terminal.

Each time you press  or , one of the available modes appears in the following sequence:

→Auto↔NTSC↔PAL↔SECAM↔PAL60↔N-PAL↔M-PAL↔4.43NTSC←

Auto: Automatically selects NTSC, PAL and SECAM.

Other than Auto: You need to select a system appropriate to the input signal.

Press  to store.

• Selecting BNC Input (BNC-Input)



All modes

You can use this option to select the signal system it will receive to BNC Input terminal.

(1) Select BNC Input and press .

BNC Input screen appears.

(2) Select the signal system to receive.

Each time you press  or , one of the available choices appears in the following sequence:

→Comp.video↔RGB-PC↔Decoder←



Comp.video: For using color difference input.

RGB-PC: For using PC with RGB signal input.

Decoder: For using decoder with RGB signal input.

(3) Press  or  to select Function.

(4) Select Comp.video or Decoder by FUNCTION to set up Mask.

Each time you press  or , one of the available choices appears in the following sequence:

→Off↔5↔10↔15←

Off: Does not mask.

Number: Masks the fringe (top, bottom, right and left) of the screen by the number of pixels specified.

(5) Press  to store.

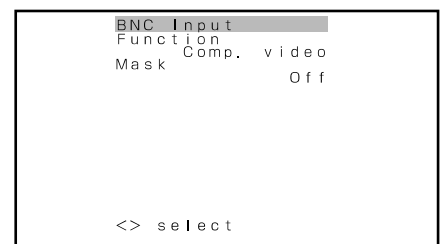

"BNC-Input" selection screen

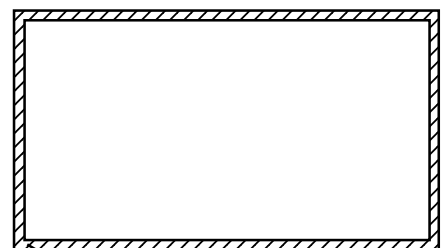

This fringe part is masked.

* On-screen information disappears if you do not take any action for about 60 seconds.

* The following abbreviations used in this document represent input modes in which you can make adjustments:

[V]: Video mode, [S]: S-video mode, [C]: Comp.video mode, [R]: RGB mode

OTHER ADJUSTMENTS (FEATURES MENU)(Continued)

INPUT TERMINAL

• Selecting D-SUB Input (D-SUB Input)



All modes

You can use this option to select the signal system it will receive to D-SUB Input terminal.

- (1) Select D-SUB Input and press .

D-SUB Input screen appears.

- (2) Select the signal system to receive.

Each time you press  or , one of the available choices appears in the following sequence:



RGB-PC \leftrightarrow Decoder

RGB-PC: For using RGB for PC

Decoder: For using digital broadcast tuner

- (3) Press  or  to select Function.

- (4) Select Decoder by FUNCTION to set up Mask.

Each time you press  or , one of the available choices appears in the following sequence:

\rightarrow Off \leftrightarrow 5 \leftrightarrow 10 \leftrightarrow 15 \leftarrow

Off: Does not mask.

Number: Masks the fringe (top, bottom, right and left) of the screen by the number of pixels specified.

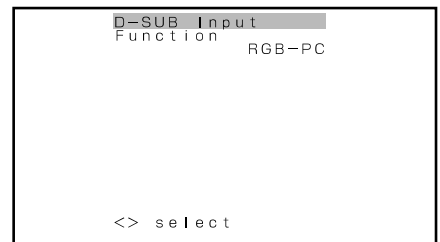

"D-SUB Input" selection screen

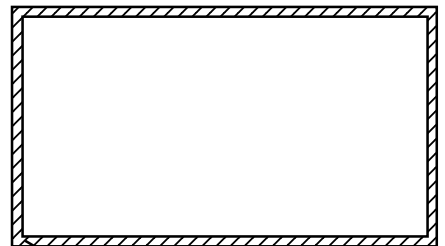

This fringe part is masked.

OTHERS MENU

• Selecting time before DPMS starts (DPMS)

All modes

You can use this option to select the amount of time before the DPMS function starts.

DPMS (which stands for "display power management signaling") allows the display to maintain an automatic power saving function.

This function causes on-screen information to disappear until the next input operation, if the power is ON and the display has not received any signals for the predetermined period of time. When DPMS is active, the power indicator lamp turns orange.

- (1) Select DPMS and press .

DPMS screen appears.

- (2) Press  or  to select Time.

- (3) Each time you press  or , one of the available choices appears in the following sequence:

\rightarrow Off \leftrightarrow 1min. \leftrightarrow 15min. \leftrightarrow 45min. \leftrightarrow 60min. \leftarrow



Off: Disables DPMS



Number: Approximate time before DPMS starts. (Unit: minutes)

* The power indicator lamp turns orange while the DPMS is ON.

* The power turns ON automatically when the display receives a signal.

- (4) Can specify background color.

Press  or  to select background color.

Each time you press  or , one of the available choices appears in the following sequence:

Black \leftrightarrow White

Black: Mutes images in Black background.

White: Mutes images in White background.

* Switches approx. 20 seconds after the display stops receiving signals.

- (5) Press  to store.

* DPMS does not function in RGB1 mode.

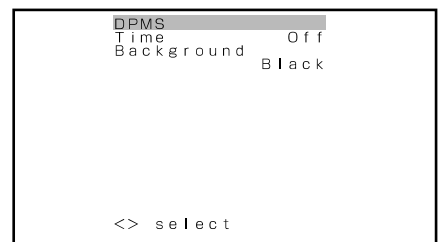

DPMS selection screen



• Selecting input terminals (Audio Input)



All modes



You can use this option to select one of the two available terminals to receive sound from input equipment.

- (1) Select "Audio Input" and press .

The "Audio Input" selection screen will appear.

- (2) Press  or  to select input equipment.
- (3) Select a desired input terminal.

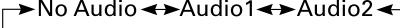
Each time you press  or , one of the available choices appears in the following sequence:

 No Audio ↔ Audio1 ↔ Audio2 

No audio: No sound in the corresponding mode.

Audio 1, Audio 2: Selects Audio 1 or 2 for receiving sound in the corresponding mode.

* Repeat steps (2) and (3) for each piece of input equipment.

- (4) Press  to store.

*Audio Input menu will not be displayed when "No Audio" is selected.

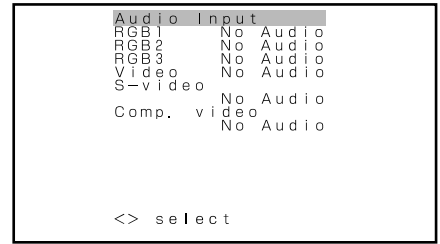

"Audio Input" selection screen



• Minimizing phosphor burn-in (Screen Orbiter)



You can use this option to move the screen position to minimize phosphor-induced "burn-in".



Follow the steps below.

- (1) Select "Screen Orbiter" and press .

The "Screen Orbiter" setting screen will appear.

- (2) Press  or  to select "Mode/Time".
- (3) Select a desired pattern.

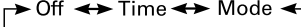



Each time you press  or , one of the available choices appears in the following sequence:



 Off ↔ Time ↔ Mode 



Off: Disables Screen Orbiter.

Time: Moves the pattern approximately every one hour.

Mode: Moves the pattern when the power is turned ON or when you switch between modes.

- (4) Press  or  to select "Moving Area".
- (5) Press  or  to select the range for moving the pattern.

Each time you press  or , one of the available choices appears in the following sequence:

 Min. ↔ Std. ↔ Max. 

Min.: Pattern moves in small range. (About 5 pixels)

Std.: Pattern moves in moderate range. (About 10 pixels)

Max.: Pattern moves in wide range. (About 15 pixels)

- (6) Press  to store.



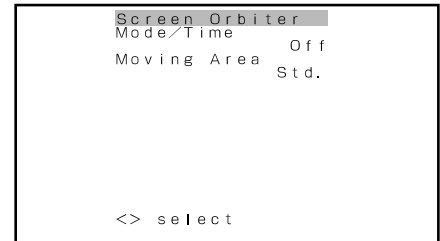





"Screen Orbiter" setting screen

* On-screen information disappears if you do not take any action for about 60 seconds.

* The following abbreviations used in this document represent input modes in which you can make adjustments:

: Video mode, : S-video mode, : Comp.video mode, : RGB mode

OTHER ADJUSTMENTS (FEATURES MENU)(Continued)

Using screen protection functions (examples)



The screen protection functions minimize phosphor burn-in but cannot completely eliminate it.

When using the display occasionally	When using the display continuously
<ul style="list-style-type: none"> Select a desired amount of time for "DPMS". Thus, when the display does not receive a signal, it will automatically display white or black over the entire screen. When the predetermined time elapses, the power will turn OFF. 	<p>When switching between RGB and video input modes only occasionally</p> <ol style="list-style-type: none"> Select "Time" for "Mode/Time" with "Screen Orbiter". Select a desired range for "Moving Area" with "Screen Orbiter". This causes the screen saver pattern to move in the same range at regular intervals. <p>When switching between RGB and video input modes frequently</p> <ol style="list-style-type: none"> Select "Mode" for "Mode/Time" with "Screen Orbiter". Select a desired range for "Moving Area" with "Screen Orbiter". When the mode is switched from Video to RGB, the display position moves.

• Input mode of priority (Input Priority)

All modes

You can use this option to switch between modes only when a signal is received through the selected input mode terminal. You cannot switch the input mode.

Each time you press  or , one of the available choices appears in the following sequence:

➔ Off ↔ RGB2 ↔ RGB3 ↔ Video ↔ S-video ↔ Comp.video ←

Off: Switches between modes normally.

Other modes: Displays pictures when a signal is received through the selected input mode terminal.

Press  to store.

*RGB1 mode cannot be selected.

• Assigning Numbers to Displays (Monitor No.)

All modes

When you use two or more displays, you can use a single remote control to control individual displays by assigning a unique number to each of the displays.

Each time you press  or , one of the available numbers appears in the following sequence:

➔ 0 ↔ 1 ↔ 2 ↔ 3 ↔ 4 ←

0: You can normally control displays.

You cannot control displays if you press any of [SHIFT 1] through [SHIFT 4].

1-4: Allows you to control a desired display by pressing the corresponding button (one of [SHIFT 1] through [SHIFT 4]).



When you do not press any of the SHIFT buttons, you can control all displays.

Press  to store.

* You can check the "Monitor No." on the Information screen. (See P.38.)

• **Setting RGB Input Signal Compulsorily (Direct Setting)** [R]

You can use this option to switch the setting for RGB input signal.

Each time you press  or , one of the available choices appears in the following sequence:

For RGB1 mode:

→ Auto ↔ VGA ↔ WVGA ↔ XGA ↔ WXGA ←

For RGB2.3 mode:

→ Auto ↔ VGA ↔ WVGA ↔ 480P ↔ XGA ↔ WXGA ↔ SXGA ↔ SXGA+ ←

Auto: The optimum display is obtained automatically for input signals.



Others: The optimum resolution setting is fixed for each signal.

Press  to store.

* In Auto mode, the resolution of VGA, WVGA, 480P, XGA, WXGA, SXGA and SXGA+ may not be automatically distinguished. Switch to the fixed display when the image is not displayed properly.

• **Specifying RGB Input Signal (Code Setting)** [R]

You can use this option to specify and display the type of RGB input signal by code number.

Each time you press  or , one of the available choices appears in the following sequence:

Auto ↔ Manual

Auto: Automatically displays the input signal to the optimum.

Manual: Selects RGB code number.

Press  to store.

* In Auto mode, the optimum resolution may not be set up automatically depending on the type of signal.

Select the type of signal when the image is not displayed properly.

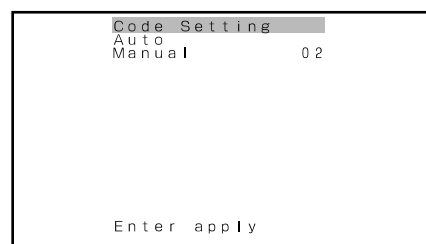

However, note that when the type of signal is selected directly, the signal of other resolution may not be displayed properly.



"Code Setting" setting screen

• **Displaying white over entire screen (White Screen)** All modes

You can use this option to display white over the entire screen to minimize phosphor burn-in.

Each time you press  or , one of the available choices appears in the following sequence:

On ↔ Off

Off: Does not display white.

On: Displays a white screen immediately.

Press  to store.

* On-screen information disappears if you do not take any action for about 60 seconds.

* The following abbreviations used in this document represent input modes in which you can make adjustments:

[V]: Video mode, [S]: S-video mode, [C]: Comp.video mode, [R]: RGB mode

OTHER ADJUSTMENTS (FEATURES MENU)(Continued)

• Setting Exhibition Mode (Exhibition Mode)

All modes

You can use this option to display the enhanced contrast, which is most suitable for the use by unspecified persons.

Each time you press  or , one of the available choices appears in the following sequence:

On \leftrightarrow Off

On: Sets up Exhibition mode.

Off: Sets up normal mode.

Press  to store.



* In Exhibition mode, the display returns to the original setting in about 5 minutes even if the adjustment is changed.

* The setup will be cancelled when removing the power plug from the receptacle.

• Horizontal/Vertical installation (Installation)

All modes

You can use this option to setup the number of fan rotation, etc. for horizontal and vertical installation.

Each time you press  or , one of the available choices appears in the following sequence:

Horizontal \leftrightarrow Vertical

Horizontal: For installing horizontally

Vertical: For installing vertically



Press  to store.

* Be sure to make this setup when changing the direction of installation.

• Locking Main Unit Button (Key Lock)

All modes

You can use this option to disable the main unit button.

Each time you press  or , one of the available choices appears in the following sequence:



On \leftrightarrow Off

On: Disables the main unit button.

Off: Enables the main unit button.

Press  to store.

• Displaying System Status (Information)

Displays system operation status.

Select "Information" and press .

The "Information" screen will appear.

Mode: Input mode appears at the upper right corner of the screen.

Monitor No.: Monitor number

Freq. Scan Mode: Frequency scanning

Input Signal: Video mode

Input Sync.: Signal type

Freq.: Frequency and polarity (fH, fV)

Preset No.: RGB code number

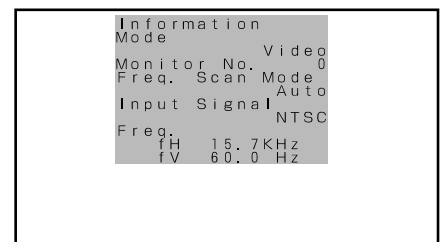



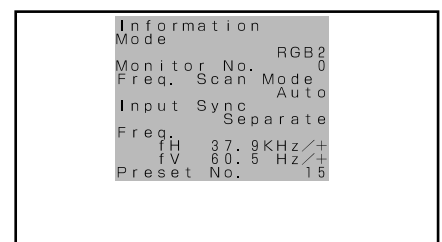

Information screen (Video Input Mode)



Information screen (RGB2 Input Mode)

* On-screen information disappears if you do not take any action for about 60 seconds.

* The following abbreviations used in this document represent input modes in which you can make adjustments:

: Video mode, : S-video mode, : Comp.video mode, : RGB mode

INITIALIZATION OF USER ADJUSTMENT VALUE(FACTORY DEFAULT)

You can restore the values of the adjustment/setting made in the MENU to factory settings.

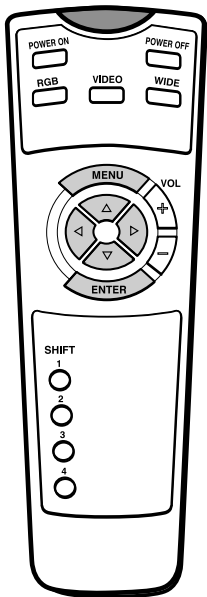

* You can also use the switches on the display's control panel to accomplish these steps.



1 Press .

The main menu screen will appear.



"FACTORY DEFAULT" selected in the main menu screen

2 Press  or  to select "FACTORY DEFAULT".

Each time you press  or , one of the available menus appears in the following sequence:

PICTURE ↔ POSITION/SIZE ↔ AUDIO ↔ FEATURES ↔ FACTORY DEFAULT



The FEATURES Menu screen will appear.

3 Press .

- Displays the message of whether to proceed with the initialization.



Displays the message of whether to proceed the initialization

4 Press  or  to select the Yes.

5 Press .

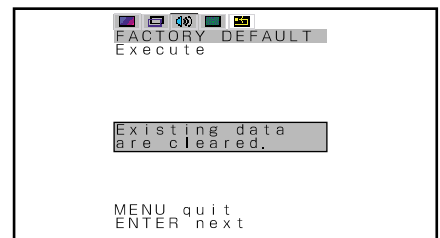

- The message of having completed the initialization will be displayed after initializing.

Press  when you finish.

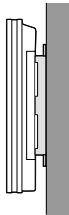
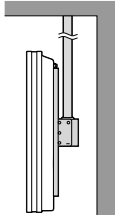
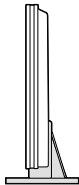
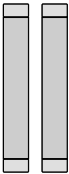

Displays the message of having completed the initialization

OPTIONS

<p>Wall-mounting unit (for both vertical and horizontal)</p>	<p>Vertical: 0° to 5° mounting angle Horizontal: 0° to 15° mounting angle</p>	<p>P-42WB12</p>	
<p>Hanging unit</p>	<p>0° to 15° mounting angle (variable) The pipe is not supplied with the ceiling-hanging unit, so consult your produce dealer.</p>	<p>P-42CT11</p>	
<p>Stand</p>		<p>P-42TT33</p>	
<p>Speaker</p>		<p>P-42SP11 (1 set of 2 speakers)</p>	
<p>Speaker Stand</p>		<p>P-42ST11 (1 set of 2 speakers stands)</p>	

- * When installing an option, make sure that all installation requirements for that option (as given in the relevant instruction manual) are met.
- * The colors of options do not match the display colors perfectly.

Warning

To prevent injury, fire, and electric shock, arrange for options to be initially installed (or installed at a different location) by your dealer.

FACTORY SETTINGS

This display can store the latest four types of signals for RGB adjustment value. The fifth input signal will replace the adjustment value of the first input signal.

To do this, select a desired signal and follow the instructions in “Adjusting Screen Position and Size” on P. 26–27 to adjust the parameters. When you finish, the settings will be automatically stored. Thus, when the display receives that signal, pictures will be displayed in accordance with the settings you most recently selected.

Main corresponding signals (RGB mode)

Display (dots x lines)	Horizontal frequency (kHz)	Vertical frequency (Hz)	Signal
640 x 480	31.47	59.94	VGA
640 x 480	37.86	72.81	VGA 72 Hz
640 x 480	37.50	75.00	VGA 75 Hz
640 x 480	43.27	85.01	VGA 85 Hz
720 x 400	31.47	70.09	400 lines
800 x 600	37.88	60.32	SVGA 60 Hz
800 x 600	48.08	72.19	SVGA 72 Hz
800 x 600	46.88	75.00	SVGA 75 Hz
800 x 600	53.67	85.06	SVGA 85 Hz
1024 x 768	48.36	60.00	XGA 60 Hz
1024 x 768	56.48	70.07	XGA 70 Hz
1024 x 768	60.02	75.03	XGA 75 Hz
1280 x 1024	63.98	60.02	SXGA 60 Hz
1280 x 1024	79.98	75.03	SXGA 75 Hz
640 x 480	35.00	66.67	MAC 13RGB
848 x 480	31.02	60.00	
852 x 480	31.72	59.97	
720 x 485	15.73	59.94	60 fields
720 x 575	15.63	50.00	50 fields
640 x 400	31.50	70.15	NEC 31 kHz

* With some input signals, “Out of range” may appear even when the horizontal and vertical frequencies are within their permissible ranges. Make sure that the vertical frequency of the input signal is 85 Hz or less for SVGA, 75 Hz or less for XVGA/ SXGA.

In the Comp.video and Video/S-video modes, the display has been factory-set as follows for different input signals:

Main corresponding signals (Comp.video mode)

Horizontal frequency (kHz)	Vertical frequency (Hz)	Signal
15.73	59.94	SDTV 480I
15.63	50.00	SDTV 576I
31.47	59.94	SDTV 480P
31.25	50.00	SDTV 576P
45.00	60.00	HDTV 720P
37.50	50.00	HDTV 720P
33.75	60.00	HDTV 1080I
28.13	50.00	HDTV 1080I

Main corresponding signals (Video, S-video mode)

Horizontal frequency (kHz)	Vertical frequency (Hz)	Signal
15.73	59.94	NTSC
15.63	50.00	PAL
15.63	50.00	SECAM
15.63	59.52	PAL60
15.63	50.00	N-PAL
15.73	59.95	M-PAL
15.73	59.94	4.43NTSC

- With the 800 x 600, 1024 x 768 and 1280 x 1024 modes, pictures of reduced size are displayed on the screen, using size reduction and interpolation. Note also that on-screen information is also displayed in reduced size.
- “Out of range” appears if the display receives a signal whose characteristic does not fall within the display’s permissible range.
- You can check input signals through “Information” on the FEATURES Menu screen. (See P. 38.)
- All terms (i.e., company and product names) used in this document are trademarks or registered trademarks.

SPECIFICATION

Model	PDS4233W/PDS4234W	
Screen size	42" wide screen: 92.0 cm (W) x 51.8 cm (H) (105.6 cm diagonal) 36.2 inch (W) x 20.4 inch (H) (41.6 inch diagonal)	
Aspect ratio	16:9 (wide)	
Weight	28.5 kg / 62.8 lbs	
Outer dimensions	103.5 (W) x 64.0 (H) x 8.5 (D) cm / 40.7 (W) x 25.2 (H) x 3.3 (D) inch	
Power supply	100–240 VAC 50/60 Hz	
Power consumption	3.5 A	
Screen dimensions	92.0 (W) x 51.8 (H) cm / 36.2 (W) x 20.4 (H) inch	
Number of pixels	852 (H) x 480 (V)	
Display modes	Video, S-video input:	Normal/Auto/Wide1/Wide2/Zoom1/Zoom2
	Component video input:	Normal/Wide1/Wide2/Zoom1/Zoom2
	RGB:	Normal/Wide/Zoom
Colors	16.77 million (for each of 256 RGB gradations)	
External equipment terminals		
Video input terminals	Video input	1 BNC terminal 1 Vp-p/75 Ω
	S-video input	1 S terminal Y: 1 Vp-p/75 Ω C: 0.286 Vp-p/75 Ω
	Component video input (color difference input)	3 BNC terminals Y: 1 Vp-p/75 Ω P _B /B-Y: 0.7 Vp-p/75 Ω P _R /R-Y: 0.7 Vp-p/75 Ω
Applicable systems	NTSC/PAL/SECAM/PAL60/N-PAL/M-PAL/4.43NTSC	
PC input terminal	RGB1 input terminal 1 DVI-D terminal RGB2 input terminal mD-sub, 3 rows, 15-pin Picture signal: 0.7 Vp-p/75 Ω Synchronization signal:TTL level RGB3 input terminal 5 BNC terminals R:0.7 Vp-p/75 Ω G:0.7 Vp-p/75 Ω B:0.7 Vp-p/75 Ω H:TTL level or 0.3 Vp-p/75 Ω V:TTL level or 0.3 Vp-p/75 Ω	
Sound terminals	2 sound input pin jacks (L/R) (2 lines) 500 mVrms/at least 22kΩ	
Control terminal	1 RS-232C connector (D-sub 9-pin)	
External speaker output terminal	Lever terminal, 1 line (L/R) Effective max. output: 9 W + 9 W (EIAJ), 8 Ω	
Operating conditions	Temperature: 0 to 40 °C / 32 to 104 °F Humidity: 20 to 90 %	
Accessories	1 remote control, 2AA batteries, 1 instruction manual, 1 power cable, 2 ferrite cores	

- Specifications and external appearance may be change for the sake of improvement.
- **Plasmavision** is a worldwide trademark of Fujitsu General Limited and is a registered trademark in Japan, the U.S.A. and other countries or areas.

Regulation ---PDS4233W

- UL, CSA Safety: UL1950/CSA C22.2 No.950
EMC: FCC Part 15 Class A, ICES-003 Class A
- CE Safety: EN60950 1992, A1: 1993, A2: 1993, A3: 1995, A4: 1997
EMC: EN55022 1998, Class A
EN61000-3-2 1995
EN61000-3-3 1995
EN55024 1998
EN61000-4-2 1995
EN61000-4-3 1996
EN61000-4-4 1995
EN61000-4-5 1995
EN61000-4-6 1996
EN61000-4-8 1993
EN61000-4-11 1994
- AS Safety: IEC60950 A1/A2/A3/A4
EMC: AS/NZS 3548

Regulation ---PDS4234W

- UL, CSA Safety: UL1950/CSA C22.2 No.950
EMC: FCC Part 15 Class B, ICES-003 Class B
- CE Safety: EN60950 1992, A1: 1993, A2: 1993, A3: 1995, A4: 1997
EMC: EN55022 1998, Class B
EN61000-3-2 1995
EN61000-3-3 1995
EN55024 1998
EN61000-4-2 1995
EN61000-4-3 1996
EN61000-4-4 1995
EN61000-4-5 1995
EN61000-4-6 1996
EN61000-4-8 1993
EN61000-4-11 1994
- AS Safety: IEC60950 A1/A2/A3/A4
EMC: AS/NZS 3548

CLEANING AND MAINTENANCE

Precautions

Be sure to remove the power plug from the receptacle before cleaning the display.
Be sure not to clean the display using a cloth dampened with volatile solvents, such as benzene or thinner. Such solvents can harm the display's cabinet, the filter at the screen front, and the remote control. They can also cause paint to come off these sections.

Cleaning the Screen

Clean the screen gently with a soft cloth.
The screen surface is fragile. Never attempt to clean it with a hard material, press on it forcefully, or tap it.

Cleaning the Cabinet and Remote Control

Use a soft cloth for cleaning.
If the cabinet or remote control is heavily stained, soak a soft cloth in a mixture of water and detergent and squeeze it dry before wiping off the stains. Use a soft, dry cloth for final cleaning.

Cleaning the ventilation grille

Remove dust from the ventilation grille in the rear of the main unit periodically with a vacuum cleaner as the accumulated dust can increase the internal temperature of the main unit causing machine failure or fire hazard.

HANDY TIPS

In the event of problems with the display, check the following explanations before contacting your dealer for servicing.

Problem	Action
• Power does not turn ON.	• Check whether the power plug is securely inserted into the receptacle.
• No pictures are displayed.	• Check cables for disconnection. • Check whether the power for all input equipment is ON. • Check for connection to wrong terminals or for wrong input mode. • Check whether the input mode display is colored pink. Special setup may have been made. Return to original setup or initialize the User adjustment value.
• Remote control does not function properly.	• Check for incorrect battery orientation. • Check for dead batteries. • Check for distance from the display. • Check whether you are pointing the remote control transmitter properly at the display's receiver. • Check for any obstacle between the remote control and the display.
• The display makes a snapping sound.	• This sound is produced when the cabinet expands or contracts due to variations in temperature. This sound does not indicate that the display has a problem.
• The display makes a buzzing sound.	• The display has fans to maintain the temperature of internal components at a constant level. This sound is produced by the fan as it rotates.
• There are spots on the screen.	• Check whether your AV equipment is affected by interference from automobiles, trains, high-voltage transmission lines, neon signs or other potential sources of interference.
• Degraded colors/tints	• Check whether all picture adjustments have been properly made. (See "Adjusting Pictures" on P. 24–25.)
• Improper screen position/size	• Check whether screen position and size have been properly adjusted. (See "Adjusting Screen Position and Size" on P. 26–27.)
• No sound from speakers	• Check cables for disconnection.
• No sound	• Check whether you have selected "No Audio" for the "Audio Input" setting. (See "Features" on P. 35.)
• If "Invalid operation" appears.	• Check whether you have selected "Input Priority". (See "Features" on P. 36.)
• If "Out of range" appears, the display is receiving a signal whose picture or signal cannot be reproduced by the display.	• Input proper signals. Make sure that the vertical frequency of the input signal is 85 Hz or less for SVGA, 75 Hz or less for XVGA / SXGA.
• The screen turns to black and white.	• Input proper signals. Make sure that the vertical frequency of the input signal is 85 Hz or less for SVGA, 75 Hz or less for XVGA / SXGA.
• If "Error message Condition 1" appears, the fan is defective.	• Remove the power plug from the receptacle, and contact your dealer for repairs.
• If "Error message Condition 2" appears, the display's internal components are extremely hot.	• Remove the power plug from the receptacle. (You can turn the power back ON again when the components have cooled sufficiently.) If the message appears again when you turn the power back on, remove the power plug from the receptacle, and contact your dealer for a repairs.
• If the power indicator lamp flashes red.	• Remove the power plug from the receptacle, and inform your dealer about how the lamp flashed. As explained below, the power indicator lamp flashes differently depending on the type of problem: – Flashes repeatedly: Improper supply voltage level – Flashes once: Malfunction by the fan – Flashes twice: Excessive temperature – Flashes three times or more: Other problems

FUJITSU

FUJITSU GENERAL LIMITED

1116, Suenaga, Takatsu-ku, Kawasaki 213-8502, Japan

A list of errata.

P.44

SPECIFICATION

Screen size

(error) ~~92.0~~ cm(W) x 51.8 cm(H) (~~105.6~~ cm diagonal)
~~36.2~~ inch(W) x 20.4 inch(H) (41.6 inch diagonal)

↓

(exactly) 92.1 cm(W) x 51.8 cm(H) (105.7 cm diagonal)
36.3 inch(W) x 20.4 inch(H) (41.6 inch diagonal)

P.44

SPECIFICATION

Operating conditions

(error) Humidity: 20 to ~~90~~ %

↓

(exactly) Humidity: 20 to 80 %