

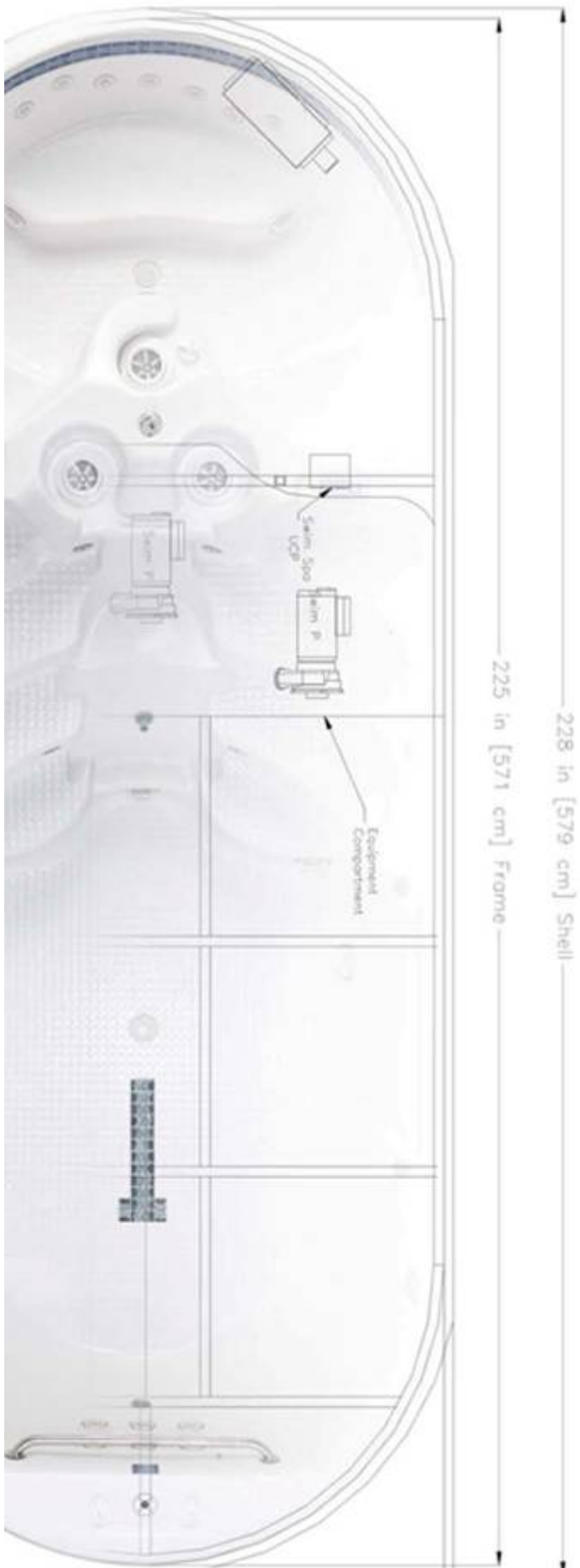

**AquaticFitnessSystems<sup>®</sup>**  
**CONSUMER PLANNING GUIDE**



# Table of Contents

<b>WARNINGS AND SAFETY CONSIDERATIONS</b> .....	<b>1</b>
IMPORTANT INSTALLATION INSTRUCTIONS.....	1
IMPORTANT WARNING .....	1
IMPORTANT SAFETY INSTRUCTIONS.....	1
IMPORTANT SAFETY INSTRUCTIONS (CANADA) (CSA SAFETY INFORMATION) .....	2
Hyperthermia .....	3
Safety Do's and Don'ts .....	4
DANGER SIGN .....	4
<b>SITE SELECTION AND PREPARATION</b> .....	<b>5</b>
CONSIDERATIONS .....	5
INSTALLATION TYPES .....	5
OUTDOOR SELF-CONTAINED.....	6
OUTDOOR INSTALLATION: BUILDER PACKAGE .....	6
INDOOR INSTALLATION .....	8
ACCESS TO SITE.....	10
TRUCK .....	10
CRANE .....	10
<b>ELECTRICAL</b> .....	<b>11</b>
ELECTRICAL REQUIREMENTS FOR NORTH AMERICA AFS.....	12
ELECTRICAL REQUIREMENTS FOR INTERNATIONAL AFS .....	12
<b>ALTERNATIVE HEATER CONNECTION (GAS OPTION)</b> .....	<b>13</b>
ALTERNATIVE HEATER CONNECTION OPTION (GAS HEATER).....	13
<b>INSTALLATION</b> .....	<b>13</b>
TESTING THE INSTALLATION .....	13
<b>CONTRACTOR INFORMATION</b> .....	<b>13</b>
ARCHITECTURAL DRAWINGS .....	13
LOCAL CODE REQUIREMENTS.....	13
<b>DELIVERY AND SETUP</b> .....	<b>14</b>
DELIVERY .....	14
SETUP .....	14
TESTING.....	15
<b>TROUBLESHOOTING GUIDE</b> .....	<b>16</b>
HEATING SYSTEM .....	16
ELECTRICAL SYSTEM.....	17
WATER SYSTEM.....	17
<b>APPENDIX A</b> .....	<b>18</b>
<b>NORTH AMERICA AFS DRAWINGS (Doc 133)</b> .....	<b>18</b>
NORTH AMERICA SITE PLAN.....	18
NORTH AMERICA CONSTRUCTION SPECIFICATIONS .....	18
NORTH AMERICA AFS VIEW .....	18
<b>INTERNATIONAL AFS DRAWINGS (Doc 199)</b> .....	<b>18</b>
INTERNATIONAL SITE PLAN.....	18
INTERNATIONAL CONSTRUCTION SPECIFICATIONS .....	18
INTERNATIONAL AFS VIEW .....	18
<b>SPECIFICATIONS</b> .....	<b>18</b>
SWIM SPACE AND WATER LEVEL .....	18
SPECIFICATIONS: AQUATIC FITNESS SYSTEMS 16.....	18
SPECIFICATIONS: AQUATIC FITNESS SYSTEMS 19.....	18
SPECIFICATIONS: AQUATIC FITNESS SYSTEMS 19 DT .....	18
<b>JUMPER SETTINGS FOR AFS PACK</b> .....	<b>18</b>
NORTH AMERICA JUMPER SETTINGS.....	18
INTERNATIONAL JUMPER SETTINGS .....	18
<b>GAS CONVERSION INSTRUCTIONS</b> .....	<b>18</b>

# WARNINGS AND SAFETY CONSIDERATIONS



## **IMPORTANT INSTALLATION INSTRUCTIONS** **READ AND FOLLOW ALL INSTRUCTIONS CAREFULLY**

- **Concrete Pad.** The AFS must be fully supported over the entire base. A typical installation on soil that will support 1,000 psi load, is 6 inch (15 cm) thick concrete with # 4 rebar on 18 inch (46 cm) centers. (Ref. Doc 138 and Doc 199 Addendum below)\*. Conditions at the site will determine the exact support requirements. Please contact your local contractor for adequate installation. Damages caused by inadequate support will not be covered by the warranty Doc 138 in the Appendix A of this document
- **Excess Water.** Normal use of the swim spa causes large amounts of water to splash out of the unit. Depending on the specific installation, additional provisions may have to be made for proper removal of this water.
- **Clearance Access:** In order to better service your product, clearance for access to AFS must be 36 inches (92 cm) at equipment compartment and 24 inches (61 cm) around the remaining area.



## **IMPORTANT WARNING** **READ AND FOLLOW ALL INSTRUCTIONS CAREFULLY**

An empty AFS should never be exposed to temperatures below 0°F (-18°C) as extreme cold can cause shell damage. This includes storage, delivery, and draining (winterizing). If your AFS can be exposed to these temperatures, keep the AFS filled and running. If you do not plan to use your AFS, you can lower the temperature setting to 61°F (16°C).

Failure to adhere to these guidelines will void the warranty.



## **IMPORTANT SAFETY INSTRUCTIONS** **READ AND FOLLOW ALL INSTRUCTIONS CAREFULLY**

Installation and use of this equipment requires the user to always follow safety precautions including:

- **Risk of Accidental Drowning.** Exercise extreme caution to prevent unsupervised children going near the Aquatic Fitness System. Children should not use the Aquatic Fitness System without adult supervision.
- **Risk of Serious Injury or Death.** If you need to replace the suction fitting or pump make sure that the flow rates are compatible. Never operate the Aquatic Fitness System if the suction fittings are broken or missing. Never replace a suction fitting with one rated less than the flow rate marked on the original suction fitting.
- **Risk of Electric Shock.** Install at least 5 FEET (1.5 m), from all metal surfaces. As an alternative, the Aquatic Fitness System may be installed within 5 feet of metal surfaces if each metal surface is permanently connected by a minimum No. 8 AWG (8.4 mm<sup>2</sup>) solid copper conductor attached to the wire connector on the grounding lug, inside the equipment compartment on the equipment can.
- **Risk of Electric Shock.** Do not permit any electrical appliance, such as a light, telephone, radio, television, etc. within 5 feet (1.5 m) of the Aquatic Fitness System. Never operate any electrical appliances from inside the Aquatic Fitness System or when you are wet.
- **Danger.** The electrical supply for this Aquatic Fitness System must include a suitably rated switch or circuit breaker to open all ungrounded supply conductors to comply with section 680-42 of the National Electrical Code, ANSI/NFPA 70-1993. The disconnect must be readily accessible and visible to the Aquatic Fitness System occupant but installed at least 5 feet (1.5 m), from the Aquatic Fitness System water.
- **Danger.** A grounding wire connector is provided on this Aquatic Fitness System to connect a minimum No. 8 AWG (8.4 mm<sup>2</sup>) solid copper conductor between this unit and any metal equipment, metal enclosures of electrical equipment, metal water pipe, or conduit within 5 feet (1.5 m) of the Aquatic Fitness System.
- **Risk of Electric Shock.** Do not attempt to remove the light housing cover without lowering the water level below the light housing cover.
- **To Reduce the Risk of Injury:** The water in the Aquatic Fitness System should never exceed 104° F (40° C). Water temperatures between 100° F (38° C) and 104° F (40° C) are considered safe for a healthy adult. Lower water temperatures are recommended for young children and when Aquatic Fitness System use exceeds 10 minutes.

- **To Reduce the Risk of Injury:** Since excessive water temperatures have a high potential for causing fetal damage during the early months of pregnancy, pregnant or possibly pregnant women should limit Aquatic Fitness System water temperatures to 100° F (38° C).
- **To Reduce the Risk of Injury:** Before entering the Aquatic Fitness System, the user should measure the water temperature with an accurate thermometer since the tolerance of water temperature-regulating devices may vary as much as +/- 5° F (2° C).
- **To Reduce the Risk of Injury:** The use of alcohol, drugs, or medication before or during Aquatic Fitness System use may lead to unconsciousness with the possibility of drowning.
- **To Reduce the Risk of Injury:** Pregnant women, the elderly, infants, or persons suffering from obesity or with a medical history of heart disease, low or high blood pressure, circulatory system problems, or diabetes, should consult a physician before using the Aquatic Fitness System. People with infectious diseases should not use an Aquatic Fitness System.
- **To Reduce the Risk of Injury:** Persons using medication should consult a physician before using the Aquatic Fitness System since some medication may induce drowsiness, while other medication may affect heart rate, blood pressure, and circulation.
- Observe a reasonable time limit when using the Aquatic Fitness System. Long exposures at high temperatures can cause high body temperature (hyperthermia, see pg. 3). Enter and exit the Aquatic Fitness System slowly. Wet surfaces can be very slippery.
- Proper chemical maintenance of Aquatic Fitness System water is necessary to maintain safe water and prevent possible damage to Aquatic Fitness System components.
- Use the cover straps and clip tie downs to secure the cover when not in use. This will help discourage unsupervised children from entering the spa and keep the spa cover secure in high wind conditions. There is no guarantee that the cover, clip tie downs, or the actual locks will prevent access to the Aquatic Fitness System.

## SAVE THESE INSTRUCTIONS



### IMPORTANT SAFETY INSTRUCTIONS (CANADA) (CSA SAFETY INFORMATION)

In addition to the preceding safety instructions, Canadian owners should read and understand the following information from the Canadian Safety Association:

## READ AND FOLLOW ALL INSTRUCTIONS CAREFULLY

- A green colored terminal or a terminal marked G, GR, Ground, Grounding, or the symbol \* is located inside the supply terminal box or compartment. To reduce the risk of electric shock, this terminal must be connected to the grounding means provided in the electric supply service panel with a continuous copper wire equivalent in size to the circuit conductors supplying this equipment.
  - IEC Publication 417, Symbol 5019.
- At least two lugs marked "BONDING LUGS" are provided on the external surface or on the inside of the supply terminal box/compartment. To reduce the risk of electric shock, connect the local common bonding grid in the area of the hot tub or Aquatic Fitness System to these terminals with an insulated or bare copper conductor not smaller than No. 6 AWG.
- All field-installed metal components such as rails, ladders, drains or other similar hardware within 3 meters of the Aquatic Fitness System or hot tub shall be bonded to the equipment grounding bus with copper conductors not smaller than No. 6 AWG.
- Children should not use Aquatic Fitness Systems or hot tubs without adult supervision.
- **AVERTISSEMENT:** NE PAS LAISSER LES ENFANTS UTILISER UNE CUVE DE RELAXATION SANS SURVEILLANCE.
- Do not use Aquatic Fitness Systems or hot tubs unless all suction guards are installed to prevent body and hair entrapment.
- **AVERTISSEMENT:** POUR ÉVITER QUE LES CHEVEUX OU UNE PARTIE DU CORPS PUISSENT TRES ASPIRÉS, NE PAS UTILISER UNE CUVE DE RELAXATION SI LES GRILLES DE PRISE D'ASPIRATION NE SONT PAS TOUTES EN PLACE.
- People using medications and/or having adverse medical history should consult a physician before using an Aquatic Fitness System or hot tub.
- **AVERTISSEMENT:** LES PERSONNES QUI PRENNENT DES MÉDICAMENTS OU ONT DES PROBLÈMES DE SANTÉ DEVRAIENT CONSULTER UN MÉDECIN AVANT D'UTILISER USE CUVE DE RELAXATION.
- People with infectious diseases should not use an Aquatic Fitness System or hot tub.

- **AVERTISSEMENT:** LES PERSONNES ATTEINTES DE MALADIES INFECTIEUSES NE DEVRAIENT PAS UTILISER UNE CUVE DE RELAXATION.
- To avoid injury, exercise care when entering or exiting the Aquatic Fitness System or hot tub.
- **AVERTISSEMENT:** POUR ÉVITER DES BLESSURES, USER DE PRUDENCE EN ENTRANT DANS UNE CUVE DE RELAXATION ET E SORTANT.
- Do not use drugs or alcohol before or during the use of the Aquatic Fitness System or hot tub to avoid unconsciousness and possible drowning.
- **AVERTISSEMENT:** POUR ÉVITER L'ÉVANOUISSEMENT ET LA NOYADE EVENTUELLE, NE PRENDRE NI DROGUE NI ALCOOL AVANT D'UTILISER UNE CUVE DE RELAXATION NI QUAND ON S'Y TROUVE.
- Pregnant or possibly pregnant women should consult a physician before using an Aquatic Fitness System or hot tub.
- **AVERTISSEMENT:** LES FEMMES ENCEINTES, QUE LEUR GROSSESSE SOIT CONFIRMÉE OU NON, DEVRAIENT CONSULTER UN MÉDECIN AVANT D'UTILISER UNE CUVE DE RELAXATION.
- Water temperature in excess of 38° C may be injurious to your health.
- **AVERTISSEMENT:** IL PEUT TRES DANGEREUX POUR LA SANTÉ DE SE PLONGER DANS DE L'EAU À PLUS DE 38°C.
- Before entering the Aquatic Fitness System or hot tub, measure the water temperature with an accurate thermometer.
- **AVERTISSEMENT:** AVANT D'UTILISER UNE CUVE DE RELAXATION MESURER LA TEMPÉRATURE DE L'EAU À L'AIDE D'UN THERMOMÈTRE PRÉCIS.
- Do not use an Aquatic Fitness System or hot tub immediately following strenuous exercise.
- **AVERTISSEMENT:** NE PAS UTILISER UNE CUVE DE RELAXATION IMMÉDIATEMENT APRÈS UN EXERCICE FATIGANT.
- Prolonged immersion in an Aquatic Fitness System or hot tub may be injurious to your health.
- **AVERTISSEMENT:** L'UTILISATION PROLONGÉE D'UNE CUVE DE RELAXATION PEUT TRES DANGEREUSE POUR LA SANTÉ.
- Do not permit electric appliances (such as a light, telephone, radio, television, etc.) within 1.5m of this Aquatic Fitness System or hot tub.
- **AVERTISSEMENT:** NE PAS PLACER D'APPAREIL ÉLECTRIQUE (LUMINAIRE, TÉLÉPHONE, RADIO, TÉLÉVISEUR, ETC.) À MOINS DE 1.5 M DE CETTE CUVE DE RELAXATION.
- Maintain water chemistry in accordance with manufacturer's instructions.
- **ATTENTION:** LA TENEUR DE L'EAU EN MATIÈRES DISSOUTES DOIT TRE CONFORME AUX DIRECTIVES DU FABRICANT.
- The use of alcohol or drugs can greatly increase the risk of fatal hyperthermia in hot tubs and Aquatic Fitness Systems.
- **AVERTISSEMENT:** LA CONSOMMATION D'ALCOOL OU DE DROGUE AUGMENTE CONSIDÉRABLEMENT LES RISQUES D'HYPERTHERMIE MORTELLE DANS UNE CUVE DE RELAXATION.

## SAVE THESE INSTRUCTIONS

### Hyperthermia

Prolonged immersion in hot water may induce hyperthermia. Hyperthermia occurs when the internal temperature of the body reaches a level several degrees above the normal body temperature of (98.6° F, 37° C). The symptoms of hyperthermia include dizziness, drowsiness, lethargy, and fainting. The effects of hyperthermia include:

- Failure to perceive heat,
- Failure to recognize the need to exit the spa,
- Unawareness of impending hazard,
- Fetal damage in pregnant women,
- Physical inability to exit spa,
- Unconsciousness resulting in the danger of drowning.

## Safety Do's and Don'ts

### DO

- **DO** read all operating instructions.
- **DO** read, understand and follow all Safety, Danger and Warning instructions before use.
- **DO** test water temperature with your hand before entering.
- **DO** keep the cover down when the spa or AFS remains unused.
- **DO** check on water chemistry regularly to ensure proper ph.

### DO NOT

- **DO NOT** block or sit on the filter recess area.
- **DO NOT** dive or jump into your AFS.
- **DO NOT** allow horseplay or unsupervised use of your AFS.
- **DO NOT** allow anyone to tamper or play with any of the safety or suction fittings of your spa or AFS system.

## DANGER SIGN

Every AFS has a warning sign that outlines safety precautions. Read and familiarize yourself with all warnings listed on this sign. Make the sign visible and accessible to all AFS users.

Replacement signs may be obtained from our service department at the following address:

For North America:

[Service-NorthAmerican@d1spas.com](mailto:Service-NorthAmerican@d1spas.com)

For Europe:

[Service-Europe@d1spas.com](mailto:Service-Europe@d1spas.com)





# SITE SELECTION AND PREPARATION

You have many options for installing your **Aquatic Fitness System**. By design, your **Aquatic Fitness System** is self-supporting when placed on an adequate foundation, and can be installed above ground, in deck, or in ground, allowing you to locate it almost anywhere you wish – outdoors or indoors. However, think carefully about your site location, taking into consideration climate, usage, water spillage, splashing, and drainage.

When your **Aquatic Fitness System** is in place and filled with water, it can weigh over 10 tons (20,000 lbs). **It is important that a proper foundation is built that can fully support that weight.** The **Aquatic Fitness System** must sit on a flat, level, continuous surface foundation that fully contacts the bottom of the Aquatic Fitness System. An uneven or cracked concrete pad, or the use of shims of any kind, may cause the **Aquatic Fitness System** to buckle, distort and/or crack, which will void the Warranty. We recommend you to follow closely the minimum foundation specifications which are provided in Appendix A summarized below:

- **Concrete Pad.** The AFS must be fully supported over the entire base. A typical installation on soil that will support 1,000 psi load, is 6 inch (15 cm) thick concrete with # 4 rebar on 18 inch (46 cm) centers. (Ref. Doc 138 and 199 Addendum below)\*. Conditions at the site will determine the exact support requirements. Please contact your local contractor for adequate installation. Damages caused by inadequate support will not be covered by the warranty \* Doc 138 in the Appendix A of this document
- **Excess Water.** Normal use of the swim spa causes large amounts of water to splash out of the unit. Depending on the specific installation, additional provisions may have to be made for proper removal of this water.
- **Clearance Access:** In order to better service your product, clearance for access to AFS must be 36 inches (92 cm) at equipment compartment and 24 inches (61 cm) around the remaining area.



	<p>A correctly installed pad that “meets” or “exceeds” all specifications is very important to a successful <b>Aquatic Fitness System</b> installation. An uneven or cracked concrete pad, or the use of shims of any kind, may cause the <b>Aquatic Fitness System</b> to buckle, distort and/or crack, which will void the Warranty.</p>
--	--

## CONSIDERATIONS

Important consideration must be given to the type of installation desired, the type of site access available, type of power available, and a wide range of additional items that are directly dependent on each of these major choices. First, let’s consider the type of installation you want.

## INSTALLATION TYPES

Your **Aquatic Fitness System** can be installed outdoors or indoors. It can be installed above ground, below ground (like a swimming pool), or partially inground. You can plan to have your equipment package (pumps, filters, etc.) installed under the skirt and hidden from view, or installed remotely. You should carefully consider the following items before making your final decision on the type of installation you want.

	<p><a href="#">Appendix A</a> contains a list of architectural requirements, including concrete specifications for the pad, equipment diagrams, size and shape specifications for all <b>Aquatic Fitness Systems</b>, and a blank site plan for you to sketch in your proposed installation.</p>
	<p>If installed indoors, you must provide proper ventilation. Contact an HVAC professional to ensure proper humidity control. Installation must comply with requirements as stated in HVAC application handbook (ASHRA 1999b)</p>

## OUTDOOR SELF-CONTAINED

This type of installation provides for “everything in one place.” You build a new pad (or use an existing one if it meets or exceeds the specifications required for a safe **Aquatic Fitness System** installation); bring the **Aquatic Fitness System** and the power and water to the site; hook up the equipment that is installed within **Aquatic Fitness System** under the skirt; and test it. Everything is in one place.

Be sure to keep the following things in mind when planning the installation of your **Aquatic Fitness System** outdoor:

- Local codes pertaining to fencing.
- Local building, electrical, and plumbing codes.
- View from your house.
- Wind direction.
- Exposure to sunlight
- Privacy from neighbors and roadways.
- Proximity to trees (falling leaves, branches, debris and shade).
- Proximity to overhead utility lines.



Do **not** locate **Aquatic Fitness System** under power lines!

- Dressing and bathroom location.
- Location to facilitate adult supervision.
- Landscaping and nighttime lighting.
- Ease of access to **Aquatic Fitness System** equipment access panel.
- Method of entry and exit from the **Aquatic Fitness System**; handrails and steps.
- Seating direction and view from **Aquatic Fitness System** seats.
- Storage area for maintenance equipment and chemicals
- Location of electrical power source.



Warning

**This unit requires a GFCI (Ground Fault Circuit Interrupter).** A “line of sight” service disconnect must be located where visible from the hot tub, not less than 5 feet ( $\cong 1.5$  meters) from the **Aquatic Fitness System** and not to exceed 50 feet ( $\cong 15.24$  meters) from the **Aquatic Fitness System**. This requirement may be filled with the GFCI sub-panel. **All supply wire to be rated minimum 90°C.**

## OUTDOOR INSTALLATION : BUILDER PACKAGE

This type of installation provides for “everything in more than one place.” You must first build a new pad (or use an existing one if it meets or exceeds the specifications required for a safe **Aquatic Fitness System** installation). Next you may build a shed (or use an existing building located near the pad) to house the **Aquatic Fitness System** equipment package. You will need to have electrical power and water brought to the site (and gas also if you have chosen to use a gas heater). Hook up and test the equipment that is installed in your remote location. This installation type allows you to locate the **Aquatic Fitness System** equipment package where it is convenient for you to access.



Warning

**WARNING** – It is extremely important to use spreaders whenever your Aquatic Fitness Systems is being installed.



## ABOVE GROUND

This installation type is typically the easiest because it normally requires little excavation. The **Aquatic Fitness System** is simply placed on a qualifying pad and hooked up.



## BELOW GROUND

In ground **Aquatic Fitness Systems** require a lot more planning, but can be very rewarding. Since your **Aquatic Fitness System** is completely self-supporting when placed on a proper foundation pad, backfilling with sand, gravel or earth is not recommended and will void the warranty.



- If you are planning to locate the equipment in a remote location, you will have to excavate a trench for the plumbing from the **Aquatic Fitness System** to the equipment. The depth of the trench will be dependant upon your local soil conditions and frost levels. We recommend installing the lines well below the frost line.
- After excavating the ground install a concrete foundation pad as described above.
- If you choose to leave the equipment attached to the **Aquatic Fitness System** and are installing it below grade, you must plan for complete drainage so standing water never reaches the electrical components of the spa. You must also ensure that nothing obstructs the equipment access panel, and that proper ventilation is made available to cool the equipment.
- **Clearance Access:** In order to better service your product, clearance for access to AFS must be 36 inches (92 cm) at equipment compartment and 24 inches (61 cm) around the remaining area.
- If you choose to heat your **Aquatic Fitness System** with an optional gas pool heater, the heater must be installed above ground and a minimum of five feet away from the **Aquatic Fitness System**. Check all local codes regarding the installation of gas heaters.
- If the equipment is left under the unit, drainage must be provided to drain off water. The equipment is not capable of being submerged in water. Also insure that whatever you surround the pool with does not create additional hazards; splashed water may create walking hazards and/or cause water damage.
- Check all local building, electrical, and plumbing codes to ensure that your installation is in compliance.



It is your responsibility to comply with all local codes pertaining to the installation of this product. If you back fill the **Aquatic Fitness System**, it voids any warranty.

### PARTIAL IN-GROUND

This type of installation can allow you to take advantage of any special geographical features unique to your site. For example, you may choose to excavate part of a terraced lot and put one end of the **Aquatic Fitness System** into the excavation and wrap a “ground-level” deck around it.



**WARNING** – It is extremely important to use spreaders whenever your Aquatic Fitness Systems is being installed.

### INDOOR INSTALLATION

This type of installation provides for “everything in one place – inside.” You will have some special challenges and/or considerations with an indoor installation, but the result can be very rewarding. Some important things to consider are:

When installed indoors, your **Aquatic Fitness System** has the potential to create an increased humidity condition whenever the cover is off for extended periods of time. If you install the **Aquatic Fitness System** in a closed room, a means of decreasing unwanted humidity must be provided; ventilation fans, high-capacity dehumidifier or multiple window openings for cross ventilation are some examples. Consult with your Authorized **Aquatic Fitness System** dealer for more examples or cost estimates.





**Warning**

If installed indoors, you must provide proper ventilation. Contact an HVAC professional to ensure proper humidity control. Installation must comply with requirements as stated in HVAC application handbook (ASHRA 1999b)

- Although your **Aquatic Fitness System** is designed to give years of trouble-free operation, you must plan for the possibility that your **Aquatic Fitness System** will need service or replacement. Locate your **Aquatic Fitness System** so that nothing obstructs the equipment access panel. Be sure to allow access to the **Aquatic Fitness System**, for repair or removal, when designing your indoor installation. Failure to do so may significantly increase service charges in future years.
- Building materials for all **Aquatic Fitness System** indoor installations, including but not limited to floors, walls, ceilings, doors, windows, trim, must be of materials capable of withstanding humidity and direct long-term contact with water. All furnishings must meet the same requirements.
- By the very nature of their use, **Aquatic Fitness Systems** have the potential to create a very wet environment. Dependant upon the installation and the skill level of the users, varying amounts of water may be splashed out of the **Aquatic Fitness System** at any given time. Splashed water lying on the floor may create slip hazards and/or cause water damage. You must provide for proper drainage of any water created through use of your **Aquatic Fitness System**.
- Be certain that floor load bearing capacities are adequate to support the filled weight of the **Aquatic Fitness System**, room occupants and furnishings.
- Inspect your **Aquatic Fitness System** carefully for leaks after filling and from time to time during the first 48 hours of operation. Although every **Aquatic Fitness System** is pressure tested and water tested to the most rigid industry standards before leaving the factory, in very rare instances, rough handling during transportation from the factory or at time of installation may cause a leak.
- Indoor sunrooms may create unusually high ambient temperature conditions. Always keep your **Aquatic Fitness System** covered with a solid thermal cover when it is not in use. Carefully monitor your **Aquatic Fitness System's** water temperature to ensure it does not exceed 104 F.
- Check all local building, electrical, and plumbing codes to ensure that your installation is in compliance.
- A licensed and bonded tradesman should perform all electrical, structural and plumbing work.



**Warning**

**WARNING** – It is extremely important to use spreaders whenever your Aquatic Fitness Systems is being installed.

## ACCESS TO SITE

Part of your location planning must include a review of accessibility to your proposed site.

### TRUCK

You will need to determine if a truck can access your site, or at least get close enough for a crane or large forklift to transfer your **Aquatic Fitness System** to your pad.

### CRANE





Crane or 3-Ton "All Terrain" Forklift

Because of the size and weight of the **Aquatic Fitness System**, it will be necessary to use a crane or 3-ton forklift to place your system on its pad. Make sure that you consider all access requirements including, but not limited to, overhead restrictions such as power lines and trees, surface weight limits, space between buildings, etc.



**WARNING** – It is extremely important to use spreaders whenever your Aquatic Fitness Systems is being installed.

# ELECTRICAL

 <p>Danger</p>	<b>DANGER – RISK OF ELECTRICAL SHOCK</b>
 <p>Warning</p>	<b>WARNING</b> – Be sure to read all of the following information before connecting your <b>Aquatic Fitness System</b> to any source of electricity!
 <p>Warning</p>	<b>It is the responsibility of the installer and the owner to install a readily accessible disconnecting means and a GFCI (Ground Fault Circuit Interrupter) during the installation of the Aquatic Fitness System.</b> The “line of sight” service disconnect must be located where visible from the hot tub, not less than 5 feet ( $\cong$ 1.5 meters) from the <b>Aquatic Fitness System</b> and not to exceed 50 feet ( $\cong$ 15.24 meters) from the <b>Aquatic Fitness System</b> . This requirement may be filled with the GFCI sub-panel. <b>All supply wire to be rated minimum 90°C.</b>
 <p>Note</p>	READ “IMPORTANT SAFETY INSTRUCTIONS” OF THIS MANUAL

## ELECTRICAL REQUIREMENTS FOR NORTH AMERICAN AFS

The Wiring Diagram for your **Aquatic Fitness System** is provided in the inside cover of the Lower Equipment Compartment lid. However, for your convenience, we have also provided samples of different wiring configurations for 50A/40A, and remote heater installations for both pack configurations in the **Notes and Plans** section of this document.

<b>North American AFS Electrical Requirements</b>				
Model	Power	Branch Circuit	Circuit Protection	American Wire Gauge
<b>Aqua Pro 19, AquaFit 16 And Aquafit 19 Dual Temp Swim side</b>	<b>240V</b>	<b>3 wire + ground</b>	<b>50A</b>	<b>#6 AWG</b>
	240V	3 wire + ground	40A	#6 AWG
	240V	3 wire + ground	40A w/Gas Heater**	#6 AWG
<b>AquaFit 19 DT Spa side</b>	<b>240V</b>	<b>3 wire + ground</b>	<b>40A</b>	<b>#6 AWG</b>
	240V	3 wire + ground	50A	#6 AWG

\*\* Contact your local dealer for any questions related to electrical requirements or gas heater conversion procedure. Please look at appendix A of this document for more information on gas heater conversion instructions

## ELECTRICAL REQUIREMENTS FOR INTERNATIONAL AFS

The Wiring Diagram for your **Aquatic Fitness System** is provided in the inside cover of the Lower Equipment Compartment lid. However, for your convenience, we have also provided samples of different wiring configurations for 50A/40A, and remote heater installations for both pack configurations in the **Notes and Plans** section of this document.

<b>International AFS Electrical Requirements</b>				
Model	Power	Branch Circuit	Circuit Protection	Adapted Metric Cable
<b>Aqua Pro 19, AquaFit 16 And Aquafit 19 Dual Temp Swim side</b>	<b>230 V</b>	<b>4 wire + ground</b>	<b>3 x 16 A</b>	5G6
	230 V	2 wire + ground	1 x 32 A	3G10
	230 V	3 wire + ground	2 x 16 A*	5G6
<b>AquaFit 19 DT Spa side</b>	<b>230 V</b>	<b>4 wire + ground</b>	<b>3 x 16 A</b>	5G6
	230 V	2 wire + ground	1 x 32 A	3G10
	230 V	3 wire + ground	2 x 16A*	5G6
<b>Mandatory: Connect a breaker rated for proper amperage, with 30 mA differential</b>				

\* Due to power limitations in this configuration, pump 1 and pump 3 cannot be operated in high speed at the same time.



## ALTERNATIVE HEATER CONNECTION (GAS OPTION)

### ALTERNATIVE HEATER CONNECTION OPTION (GAS HEATER)

Be sure to review the required specifications for your unit. For information on how to connect a gas heater to your unit, please refer to the Appendix A of this document.

## INSTALLATION

### TESTING THE INSTALLATION

Be sure to inspect all electrical, gas (if installed), and plumbing connections. All connections must meet or exceed local codes.

Once filled with water, turn on the power and run the motors, check filters, lights, heater, etc. to make sure that everything is correctly connected and in proper working order.

Be sure to check closely for leaks that might be caused by loose connections or shipping damage. If you find any leaks that were caused by shipping damage, contact the Dimension One Spas Inc. Warranty Department immediately for assistance.



## CONTRACTOR INFORMATION

### ARCHITECTURAL DRAWINGS

Architectural drawings (doc 133 and 195) are available in the Appendix A or at [www.AquaticFitnessSystems.com/installation](http://www.AquaticFitnessSystems.com/installation)

### LOCAL CODE REQUIREMENTS

Be sure to check all local code requirements before planning your installation. Some local codes are more stringent than others.

 Caution	Normal use of the <b>Aquatic Fitness Systems</b> causes large amounts of water to splash out of the unit. These foundation specifications are only for mechanical support of the <b>Aquatic Fitness System</b> . Depending on the specific installation, additional provisions will have to be made for proper drainage of the water around the slab.
 Note	Verify with owner, location of all depressions, openings, cast in place accessories, etc. prior to construction. See <a href="#">Appendix A</a> for more detailed information.
 Warning	As soil conditions vary, we advise you to check with a local contractor to give you guide lines that determine the thickness of the foundation pad needed. See Appendix A for more detailed information.

Locate your **Aquatic Fitness System** so that the equipment is above grade and not susceptible to groundwater or flooding. If you are building your **Aquatic Fitness System** into the ground and require your equipment to also be located underground, you must build a watertight vault with a sump-pump for proper water evacuation. Water must always drain away from the **Aquatic Fitness System**.

 Caution	Sufficient drainage must be available to prevent the equipment from ever being submerged. Failure to provide sufficient drainage will void the Warranty.
--	--

The entire end of your **Aquatic Fitness System** containing the equipment access panel must remain accessible in order to allow routine maintenance of your **Aquatic Fitness System** equipment. It is imperative that the owner and users of this **Aquatic Fitness System** carefully read all instructions in this manual prior to having your **Aquatic Fitness System** installed at your chosen location, whether indoors or outdoors.

 Caution	Improper installation may result in equipment damage and will void the Warranty.
--	--

## DELIVERY AND SETUP

### DELIVERY

The site will require access by a flat-bed truck and a crane or heavy-duty fork lift.

 Caution	An empty AFS should never be exposed to temperatures below 0°F (-18°C) as extreme cold can cause shell damage. This includes storage, delivery, <u>and</u> draining (winterizing). If your AFS can be exposed to these temperatures, keep the AFS filled and running. If you do not plan to use your AFS, you can lower the temperature setting to 61°F (16°C).  Failure to adhere to these guidelines will void the warranty.
--	--

### SETUP

Your Dimension One Aquatic Fitness System has a very high quality finish. Stains and dirt will generally not adhere to this surface. You may clean your AFS's surface with an approved cleaner such as Leisure Time Multi-Purpose Cleaner. Check with your dealer before using any household cleaning products on your AFS. Do not use any "409" type cleaners or any cleaners containing abrasives, as these will damage the AFS shell surface.

Fill the **Aquatic Fitness System** with water. The **Aquatic Fitness System** should be filled until the water level is approximately 2 inches (5 centimeters) above the bottom of the tile line.

### CONNECT POWER

Turn on the circuit breaker for your **Aquatic Fitness System** on your house panel. The main pump will start in one of the modes as described under the **Aquatic Fitness System** side control functions.

Select jets (main pump) on high speed. Let the system run for a few minutes to bleed air out of the plumbing system. Select second pump on high speed. If the system does not prime after 2 minutes of running, turn off electrical power to the **Aquatic Fitness System**.

 Caution	RUNNING ANY PUMP DRY FOR AN EXTENDED PERIOD WILL PERMANENTLY DAMAGE THE PUMP.
--	---

The air control valves on the **Aquatic Fitness System** labeled "max" and "min" regulate the amount of air drawn through the **Aquatic Fitness System's** jets. More air produces a more vigorous massage. Your **Aquatic Fitness System** will heat quicker with the air valves set to "min".

With the **Aquatic Fitness System** operating, gradual heating of the water takes place over 12 to 24 hours. After initial startup, the low speed pump will start running if the water temperature is below 85°F (29.4°C) Monitor the temperature and adjust the setting as desired. The water temperature must never exceed 104 F.



Please read and follow the remaining instructions in this owner's manual, including instructions on water treatment. Proper water treatment is critical to the maintenance of your **Aquatic Fitness System's** equipment as well as your own health and satisfaction.



Be sure to refer to the Water Care Guide (P/N 01513-192) in order to test and treat your water properly.

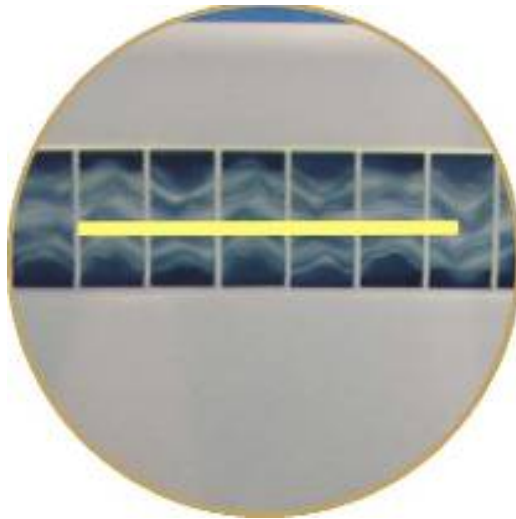

## TESTING

### TEST THE TOP SIDE CONTROL

Refer to the Owner's Manual that was shipped with the Aquatic Fitness System for instructions on how to use and program the Top Side Control. Be sure to test each controllable setting.

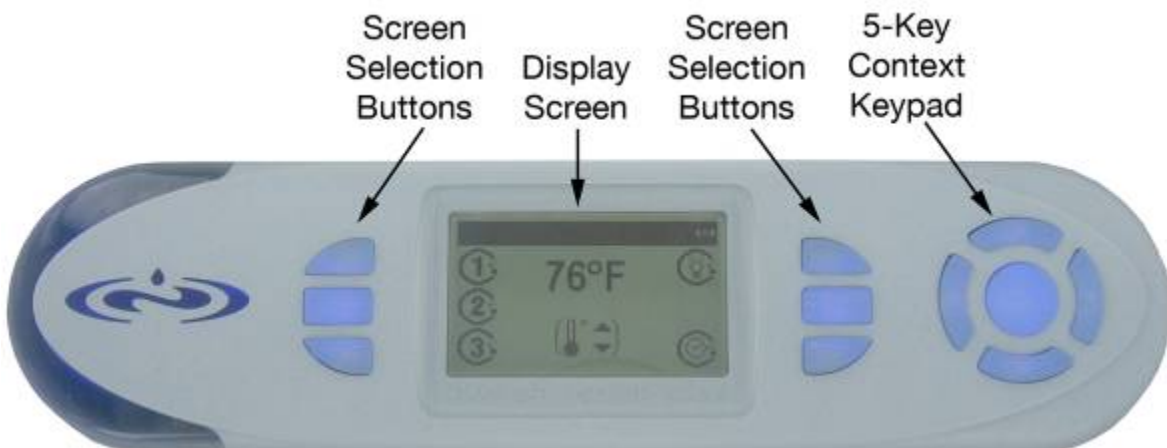

# TROUBLESHOOTING GUIDE

## HEATING SYSTEM

Symptom	Problem	Corrective Action
<b>Does not heat</b>	1. Temperature setting is too low	1. Turn up the "set temperature" on the control panel
	2. Dirty filter	2. Clean filter
	3. Flow switch malfunction	3. Call your dealer for service
<b>Too hot</b>	1. Temperature setting too high	1. Turn down the "set temperature" on the control panel
	2. High limit tripped	2. Call your dealer for service
<b>Flashing temperature of 34°F (≈1° C) or 134°F (≈56° C) appears on the display</b>	Possible temperature sensor failure	Call your dealer for service
<b>Hot Tub Temperature erratic</b>	Water level	Fill hot tub to about six inches below the top of the spa or 1" (2.54 cm) to 2" (5.08 cm) above the bottom of the tile line.
<b>Display reads OVERHEAT</b>	1. Too much filtration	1. Reduce the number of filter cycles and/or the filter cycle duration
	2. Temperature setting too high	2. Turn down the "set temperature" on the control panel
	3. High limit or sensor problem	3. Call your dealer for service

## ELECTRICAL SYSTEM

Symptom	Problem	Corrective Action
Will not turn on – in any mode	No power	Check circuit breaker and/or GFCI
Turns on by itself	Normal automatic daily filtration, or anti-freeze cycle	No action required
Light is out	Burned out bulb	Replace bulb
Pump shuts down unexpectedly while in use	1. Automatic timer has shut pump off	1. Push JETS Button again to start another cycle. If desired, reprogram automatic pump timer for longer duration.
	2. Motor over-heated and automatic protective device has shut down pump(s)	2. If pump(s) will not restart when JETS Button is pushed, call for service  Make sure that the equipment panel vent area is not blocked. Vent blockage can cause serious damage to your equipment.

## WATER SYSTEM

Symptom	Problem	Corrective Action
Pulsing jets	Water level too low	Fill spa to proper water level
No Jet Action, or action is poor	1. Jets turned off	1. Turn jets on by turning jet face clockwise
	1. Selector Valve turned	1. Turn the Selector Valve to the appropriate position
	3. Dirty Filter	3. Clean Filter
	4. Air lock	4. Loosen pump union to allow air to bleed
	5. Gate valve closed	5. Open gate valve

# **APPENDIX A**

## **NORTH AMERICA AFS DRAWINGS (Doc 133)**

**NORTH AMERICA SITE PLAN**  
**NORTH AMERICA CONSTRUCTION SPECIFICATIONS**  
**NORTH AMERICA AFS VIEW**

## **INTERNATIONAL AFS DRAWINGS (Doc 199)**

**INTERNATIONAL SITE PLAN**  
**INTERNATIONAL CONSTRUCTION SPECIFICATIONS**  
**INTERNATIONAL AFS VIEW**

## **SPECIFICATIONS**

**SWIM SPACE AND WATER LEVEL**  
**SPECIFICATIONS: AQUATIC FITNESS SYSTEMS 16**  
**SPECIFICATIONS: AQUATIC FITNESS SYSTEMS 19**  
**SPECIFICATIONS: AQUATIC FITNESS SYSTEMS 19 DT**

## **JUMPER SETTINGS FOR AFS PACK**

**NORTH AMERICA JUMPER SETTINGS**  
**INTERNATIONAL JUMPER SETTINGS**

## **GAS CONVERSION INSTRUCTIONS**







# NORTH AMERICA AFS VIEW

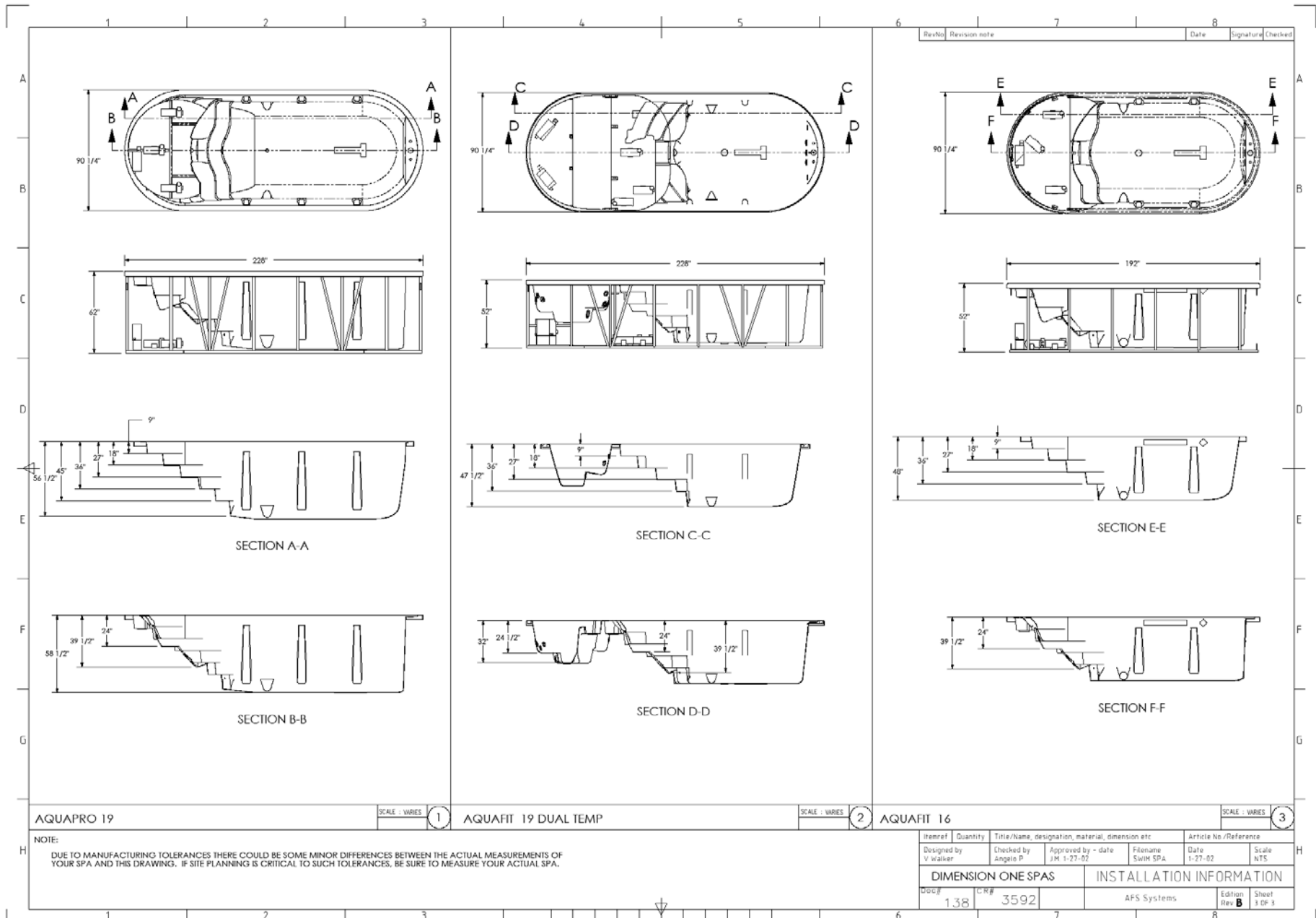

# INTERNATIONAL AFS DRAWINGS (Doc 199)

INTERNATIONAL SITE PLAN (Available in bigger size at [www.AquaticFitnessSystems.com/installation](http://www.AquaticFitnessSystems.com/installation))

Rev/No		Revision note	Date	Signature	Checked
B	SHELL DESIGN UPDATES		6/2/05	DP	AP

<b>GENERAL SPECIFICATIONS</b> Spa Size: _____ Depth: _____ Sq. Ft. Shape: _____ Area: _____ Sq. Ft. Perimeter: _____ M Volume: _____ Liters Filter Rate: _____ LPH Turnover rate: _____ Hrs.	
<b>EIGNITION:</b> Access: _____ No. Lights: _____ Fence Removal: <input type="checkbox"/> Cont. <input type="checkbox"/> Owner Fence Replaced by: <input type="checkbox"/> Cont. <input type="checkbox"/> Owner Remove Det: <input type="checkbox"/> Leave Det: <input type="checkbox"/> Sew Out: <input type="checkbox"/> Concrete Removal: <input type="checkbox"/> Sola/Construction Report: <input type="checkbox"/> Cont. <input type="checkbox"/> Owner <input type="checkbox"/> Not Req'd.	
SPA Model: _____ Note: Refer to product specification sheet for details	
<b>SPA FILTRATION:</b> Filter Type: _____ Make & Model: _____ Size: _____ Area: _____ Sq Ft. Circulation Pump Model: _____ LPH _____ LPH @ _____ Ft Head _____ Volts _____ PH Clean Type: _____	
<b>HYDRO-THERAPY EQUIPMENT:</b> Therapy Pump(s) Model: _____ HP _____ LPH _____ Volts _____ PH	
<b>SPA HEATING:</b> <input type="checkbox"/> Fuel _____ <input type="checkbox"/> Natural Gas <input type="checkbox"/> Propane <input type="checkbox"/> Oil Make & Model: _____ BTU Input _____ Vent Size _____ Combustion Ventilation Req'd _____ Sq Ft <input type="checkbox"/> Electric Make & Model _____ KW _____ Phase _____ Volts _____	
<b>SPA FITTINGS:</b> Main Output: _____ Size _____ Qty _____ Stimmers: _____ Type _____ Qty _____ Sides: _____ Type _____ Qty _____ Therapy Jets: _____ Type _____ Qty _____	
<b>SPA PIPING / PLUMBING:</b> Filter: _____ Gas Heater Piping: <input type="checkbox"/> Copper <input type="checkbox"/> Galvanized at four feet (121 cm) spacing and following the heater. Pool Piping: _____ PVC Schedule 40 (Size as per plan)	
POOL/SPA CONTRACTOR TO IDENTIFY ALL VALVES & PIPING	
ADDITIONAL: _____	
CONTRACTOR LICENSE(S): _____	

<b>SITE INFORMATION</b>	
<b>IMPORTANT NOTE FOR GENERAL CONTRACTOR</b> AT ALL NEW SERVICES & DRAINING TRENCHES PROVIDE "WARNING" TAPE AT 30.45cm BELOW GRADE	<b>GENERAL CONDITIONS</b> 1. ANY SUBSTITUTIONS, REVISIONS OR ADDITIONS TO THE PLANS ARE TO BE APPROVED IN THE FIELD BY OWNER OR ARCHITECT. CONTRACTOR WILL TAKE FULL RESPONSIBILITY FOR ADJUSTMENTS TO ANY MATERIAL OR WORK THAT IS NOT APPROVED. 2. ALL WORK IS TO BE PERFORMED BY LICENSED, INSURED FIRMS WHO ARE ACTIVE & EXPERIENCED IN THE RESPECTIVE TRADES REPRESENTED ON THE DINGS & EXECUTED TO THE HIGHEST STANDARDS OF THOSE TRADES. 3. CONTRACTOR SHALL COORDINATE HIS WORK W/ ALL RELATED TRADES. 4. ALL WORK SHALL BE IN COMPLIANCE W/ ALL LOCAL CODES, ORDINANCES & MFG INSTRUCTIONS & SPECIFICATIONS. 5. ALL WORK IS SUBJECT TO APPROVAL OF THE OWNER/ARCH OR THEIR REPRESENTATIVE. 6. VERIFY ALL DIM ON SITE & NOTIFY THE OWNER/ARCH OF ANY DISCREPANCIES PRIOR TO CONSTRUCTION. DO NOT PROCEED UNTIL ANY NECESSARY ADJUSTMENT ARE MADE.
7. PROVIDE FOR RACEWAYS FOR OTHER TRADES UNDER SLABS & FOOTINGS (SUCH AS POOL, PLUMBING, IRRIGATION, ELEC ETC.) 8. CONTRACTOR SHALL PROVIDE ALL LABOR, EQUIP., MATERIALS & SUPPLIES TO INSTALL ALL WORK ON THE PLANS & AS SPECIFIED HEREIN. 9. CONTRACTOR SHALL OBTAIN & PAY FOR ALL REQUIRED INSPECTIONS, PERMITS & FEES. PROVIDE NOTICES READ BY GOVERNMENTAL AUTHORITIES. FILE DINGS AS NECESSARY, SCHEDULE INSPECTIONS & TESTS & SUBMIT CERTIFICATES OF APPROVAL UPON COMPLETION. 10. CONTRACTOR SHALL PROMPTLY NOTIFY THE OWNER/ARCH OF ANY WORK OUTLINED ON THE PLANS OR SPICES THAT IS NOT IN ACCORDANCE W/APPLICABLE LAWS, CODES & REGULATIONS, W/OUT SUCH NOTICE & APPROPRIATE MODIFICATIONS BY OWNER/ARCH, THE CONTRACTOR ASSUMES FULL RESPONSIBILITY FOR ANY WORK EXECUTED WHICH IS CONTRARY TO SUCH LAWS, CODES & REGULATIONS. 11. DUE TO MANUFACTURING TOLERANCES THERE COULD BE SOME MINOR DIFFERENCES BETWEEN THE ACTUAL MEASUREMENTS OF YOUR SPA AND THE DRAWINGS INDICATED HERE. IF SITE PLANNING IS CRITICAL TO SUCH TOLERANCES, BE SURE TO MEASURE YOUR ACTUAL SPA. 12. ALL DIMENSIONS ARE IN CENTIMETERS.	<b>PROJECT SYMBOLS</b> - - - - - SERVICE LINE - - - - - PERIMETER LINE - - - - - ORIGINAL SETBACK - - - - - NEW SETBACK - - - - - EXISTING WALL IN EXISTING SPA - - - - - NEW SPA

Item#	Quantity	Title/Name, designation, material, dimension etc	Article No./Reference		
Designed by V Walker	Checked by Angelo P	approved by - date Filename	Date L-26-02	Scale NTS	
Doc# 199		CR# 3592	DIMENSION ONE SPAS SWIM SPA INTALLATION, EXPORT		
SITE INFORMATION			Edition B	Sheet 1 OF 3	

# INTERNATIONAL CONSTRUCTION SPECIFICATIONS

**FOUNDATION PLAN**

**FOUNDATION SECTION**

**CONCRETE SECTION DETAIL**

**CONCRETE SPECIFICATIONS**

SCALE: VARIES 1

**REMOTE GAS HEATER DIAGRAM**

SCALE: VARIES 3

**REMOTE EQUIPMENT DIAGRAM**

SCALE: VARIES 2

**SELF CONTAINED DIAGRAM**

SCALE: VARIES 4

**GENERAL NOTES & CONDITIONS**

SCALE: NONE 5

Item#	Quantity	Title/name, designation, material, dimension etc	Article No./Reference
Designed by	Checked by	Approved by - date	Filename
V. Walker	Angelo P		

**DIMENSION ONE SPAS**

Doc# 1338 CR# 3592

Edition B Sheet 2 OF 3

# INTERNATIONAL AFS VIEW

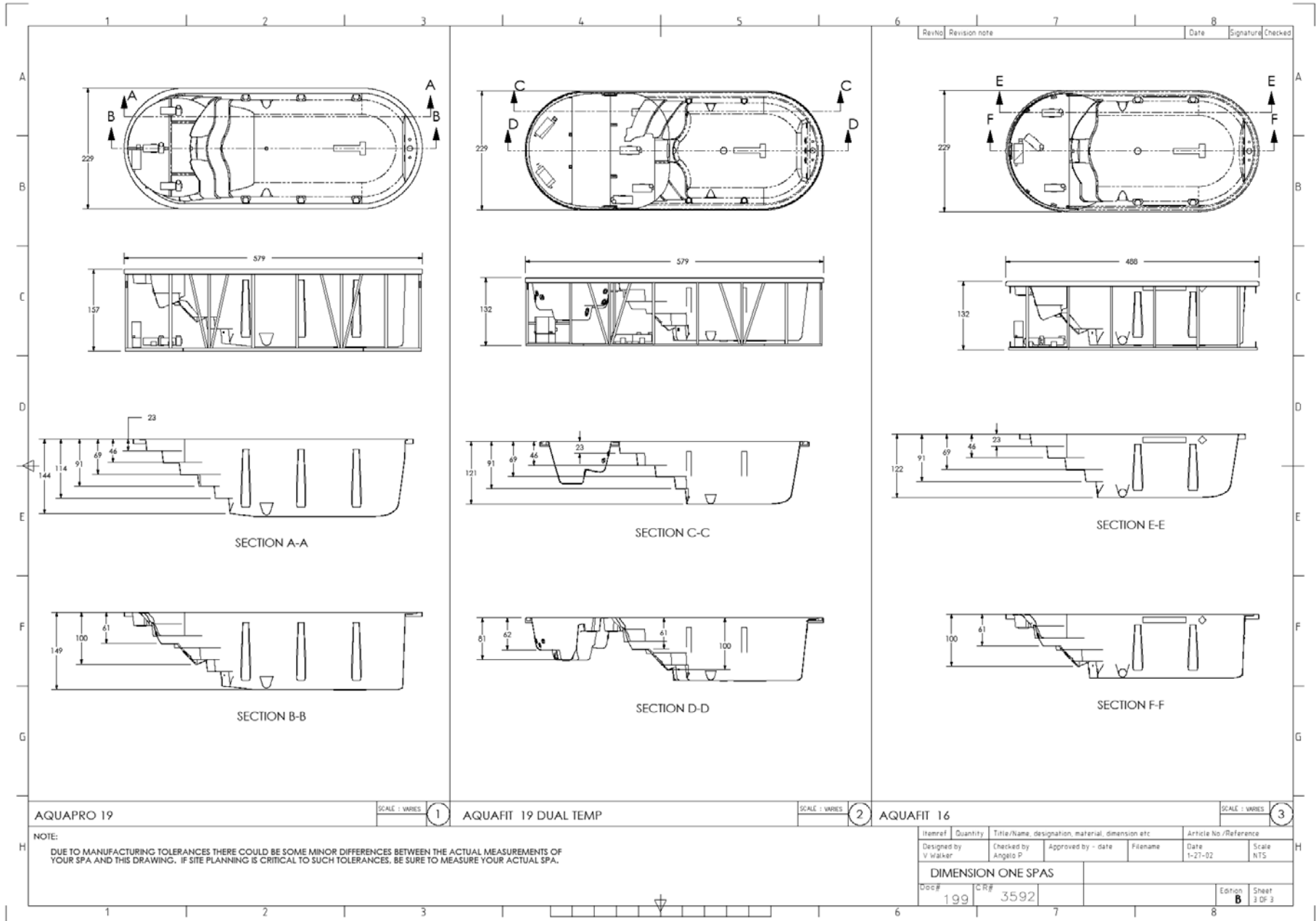



# SPECIFICATIONS

## SWIM SPACE AND WATER LEVEL

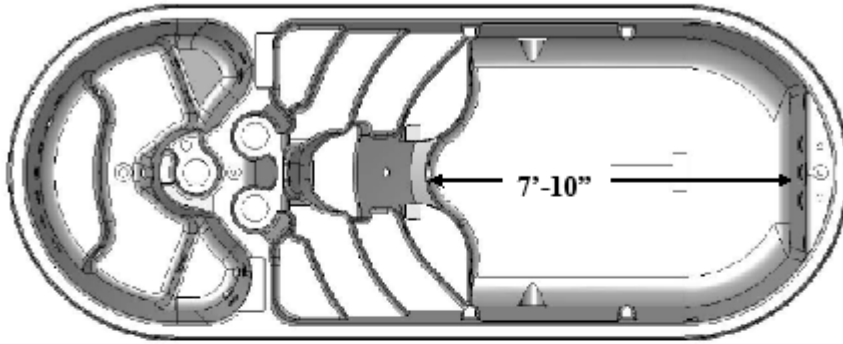

### **AFS 19DT**

Water Level: 42 inches (~106 cm)

Swim Space: 7'10" (~238 cm)

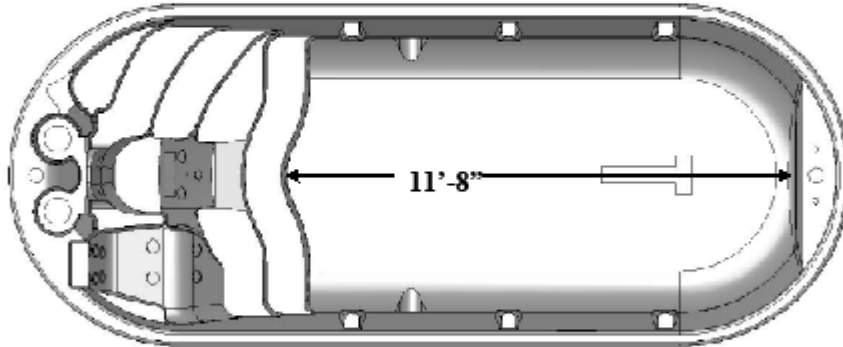

### **Aquapro 19**

Water Level: 52 inches (~132 cm)

Swim Space: 11'8" (~355 cm)

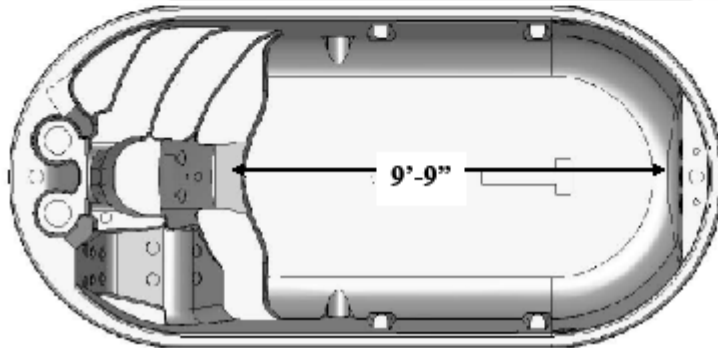

### **AFS 16**

Water Level: 42 inches (~106 cm)

Swim Space: 9'9" (~297 cm)

## SPECIFICATIONS: AQUATIC FITNESS SYSTEMS 16

General	
Shape	Oval
Seating Capacity	n/a
Shell Material	DuraTex™
Dimensions	90½" x 192" x 52" H / (229cm X 488cm x 132cm H)
Corner Radii	N/A
Water Capacity	1700 Gallons (6440 Liters)
Dry Weight	2400 lbs (1090 kg)
Shipping Weight	2400 lbs (1090 kg)
Full Weight	17100 lbs (7760 kg)
Skirt Material	Wood or Synthetic optional

Water System	
Water Treatment System	CD - Ozone*
Plumbing Systems	2
Filters/Coverage	2 / 75 sq. ft.
Gate Valves	8
VCR Jet® - Air Adjustable/Directional	0
VCR Jet® - Rotator	0
VCR Jet® - Dual Rotator	0
VCR Jet® - Multi Port Spinner	0
VCR Jet® - Mini Rotator	4
VCR Jet® - Mini Directional	10
VCR Jet® - Euro Directional	0
VCR Jet® - Euro Rotator	0
VCR Jet® - Mini Directional in NFJ	0
Typhoon Jet	0
Swim Jets	6
Ozone Jet	2 *
Heater Return Jet	1 *
Pump Returns	5
Diverter Valves	1
Floor Drains	1
Skimmer	2 - 8" Weir

Special Features	
NeckFlex® Jet Pillows	0
Headrest Pillows	1
Optimounts™	12
Tether Mount	2
Bar	1
Swim Jet Air Valves	2
Swim Tether	1

Pump Information	Domestic (60Hz)	Export (50Hz)
Motor Size – Peak (Continuous) HP	5.0 (3.0) HP	3.6 (2.0) HP
Jet Pumps # of Pumps/Speed	One / Dual & Two / Single	One / Dual & Two / Single
Circulation pump	0	0
Electrical System	Domestic (60Hz)	Export (50Hz)
Voltage	240	230
Amperage	50/40	1x32 / 3x16 / 2x16
Heater	5.5 kW *	5.2 kW *
Thermostat	Electronic *	Electronic *
Light	2 Multi color LED**	2 Multi color LED**
Control System	Gecko Alliance*	Gecko Alliance*
Upper Control	Gecko Alliance*	Gecko Alliance*



- Note: 1. Subject to change without notice.  
 2. \* For builder's pack models the following equipment is not supplied.  
 Ozone Jets, Heater return jet, water treatment system, heater, thermostat, upper control, control system and pumps.  
 3. \*\* Builder's pack light is an incandescent bulb

## SPECIFICATIONS: AQUATIC FITNESS SYSTEMS 19

General		
Shape	Oval	
Seating Capacity	n/a	
Shell Material	DuraTex™	
Dimensions	90¼" x 228" x 62" H / (229cm X 579cm x 157cm H)	
Corner Radii	N/A	
Water Capacity	2400 Gallons (9085 Liters)	
Dry Weight	3600 lbs (1633 kg)	
Shipping Weight	3600 lbs (1633 kg)	
Full Weight	23600 lbs (10705 kg)	
Skirt Material	Wood or Synthetic optional	
Water System		
Water Treatment System	CD - Ozone*	
Plumbing Systems	2	
Filters/Coverage	2 / 75 sq. ft.	
Gate Valves	8	
VCR Jet® - Air Adjustable/Directional	0	
VCR Jet® - Rotator	0	
VCR Jet® - Dual Rotator	0	
VCR Jet® - Multi Port Spinner	0	
VCR Jet® - Mini Rotator	4	
VCR Jet® - Mini Directional	8	
VCR Jet® - Euro Directional	0	
VCR Jet® - Euro Rotator	0	
VCR Jet® - Mini Directional in NFJ	4	
Typhoon Jet	0	
Swim Jets	6	
Ozone Jet	2 *	
Heater Return Jet	1 *	
Pump Returns	5	
Diverter Valves	1	
Floor Drains	1	
Skimmer	2 - 8" Weir	
Special Features		
NeckFlex® Jet Pillows	1	
Headrest Pillows	0	
Optimounts™	14	
Tether Mount	2	
Swim Bar	1	
Swim Jet Air Valves	2	
Swim Tether	1	
Pump Information		
	Domestic (60Hz)	Export (50Hz)
Motor Size – Peak (Continuous) HP	5.0 (3.0) HP	3.6 (2.0) HP
Jet Pumps # of Pumps/Speed	One / Dual & Two / Single	One / Dual & Two / Single
Circulation pump	0	0
Electrical System		
	Domestic (60Hz)	Export (50Hz)
Voltage	240	230
Amperage	50 / 40	1x32 / 3x16 / 2x16
Heater	5.5 kW *	5.2 kW *
Thermostat	Electronic *	Electronic *
Light	2 Multi color LED**	2 Multi color LED**
Control System	Gecko Alliance *	Gecko Alliance *
Upper Control	Gecko Alliance *	Gecko Alliance *



- Note: 1. Subject to change without notice.  
 2. \* For builder's pack models the following equipment is not supplied.  
 Ozone Jets, Heater return jet, water treatment system, heater, thermostat, upper control, control system and pumps.  
 3. \*\* Builder's pack light is an incandescent bulb.



## SPECIFICATIONS: AQUATIC FITNESS SYSTEMS 19DT

General		
Shape	Oval	
Seating Capacity	n/a	
Shell Material	DuraTex™	
Dimensions	90 1/4" x 228" x 52" H // (229cm X 579cm x 132cm H)	
Corner Radii	N/A	
Water Capacity	1730 Gallons (6550 Liters) swim 1450 Gallons (5490 Liters) spa 280 Gallons (1060 Liters)	
Dry Weight	3500 lbs (1590 kg)	
Shipping Weight	3500 lbs (1590 kg)	
Full Weight	18000 lbs (8200 kg)	
Skirt Material	Wood or Synthetic optional	
Water System		
Water Treatment System	CD - Ozone (swim) / UV bulb (spa)	
Plumbing Systems	4	
Filters/Coverage	3 / 75 sq. ft.	
Gate Valves	10	
VCR Jet® - Air Adjustable/Directional	0	
VCR Jet® - Rotator	0	
VCR Jet® - Dual Rotator	0	
VCR Jet® - Multi Port Spinner	0	
VCR Jet® - Mini Rotator	8	
VCR Jet® - Mini Directional	8	
VCR Jet® - Euro Directional	0	
VCR Jet® - Euro Rotator	0	
VCR Jet® - Mini Directional in NFJ	0	
Typhoon Jet	1	
Swim Jets	6	
Ozone Jet	2 swim, 1 spa	
Heater Return Jet	1 swim, 1 spa	
Pump Returns	5 swim, 2 spa	
Diverter Valves	1	
Floor Drains	1 swim, 1 spa	
Skimmer	3 - 8' Weir	
Special Features		
NeckFlex® Jet Pillows	0	
Headrest Pillows	0	
Optimounts™	10	
Tether Mount	2	
Swim Bar	1	
Swim Jet Air Valves	2	
Swim Tether	1	
Pump Information		
	<b>Domestic (60Hz)</b>	<b>Export (50Hz)</b>
Swim Motor Size – Peak (Continuous) HP	5.0 (3.0) HP	3.6 (2.0) HP
Swim Jet Pumps # of Pumps/Speed	One / Dual & Two / Single	One / Dual & Two / Single
Spa Motor Size – Peak (Continuous) HP	4.0 (2.0) HP	3.6 (2.0) HP
Spa Jet Pumps # of Pumps/Speed	One/ Single	One/ Single
Circulation pump	1 spa side	1 spa side
Electrical System		
	<b>Domestic (60Hz)</b>	<b>Export (50Hz)</b>
Voltage	240	230
Amperage - swim	50 / 40	3x16 / 2x16 / 1x32
Amperage - spa	50 / 40	3x16 / 2x16 / 1x32
Heater	5.5 kW	5.2 kW
Thermostat	Electronic	Electronic
Light	3 Multi color LED	3 Multi color LED
Control System - swim	Gecko	Gecko
Upper Control - swim	Gecko	Gecko
Control System - spa	Gecko	Gecko
Upper Control - spa	Gecko	Gecko



Note: 1. Subject to change without notice.  
2. Builder Pack model not available.

# JUMPER SETTINGS FOR AFS PACK

## NORTH AMERICA JUMPER SETTINGS

All jumpers are read at power-up only.

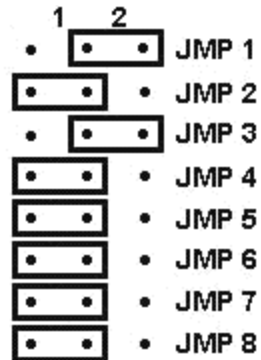

Jumper Number	Function	Position 1 (Left)	Position 2 (Right)
JMP-1	Maximum amperage draw	<b>50Amp</b>	40Amp
JMP-2	Heat associated pump/ default set point	<b>Circulation Pump/100°F</b>	Pump 1/85°F
JMP-3	Pump 2 not installed	x	
JMP-4	Pump 3 not installed	X	
JMP-3	Pump 2 is single speed	X	
JMP-4	Pump 3 not installed		X
JMP-3	Pump 2 is dual speed		X
JMP-4	Pump 3 not installed		X
<b>JMP-3</b>	<b>Pump 2 is single speed Pump 3 is single speed</b>		<b>X</b>
<b>JMP-4</b>		<b>X</b>	
JMP-5	Waterfall	<b>Installed</b>	Not Installed
JMP-6	Dynamic Lighting	<b>Installed</b>	Not Installed
JMP-7	Heater management	<b>Enabled (restricted)</b>	Disabled**
JMP-8	Not used	---	---

Default settings shown in **Bold**.

\*\* If jumper 7 is set to position 2, Heater management is disabled and heat is driven between P63 and P66.

## INTERNATIONAL JUMPER SETTINGS

All jumpers are read at power-up only.

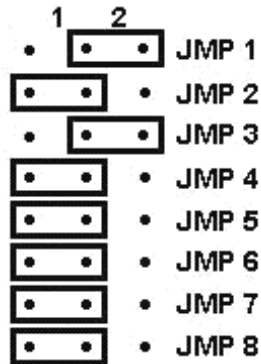

Jumper Number	Function	Position 1 (Left)	Position 2 (Right)
JMP-1	Input is 2x16Amp	X	
JMP-2			X
<b>JMP-1</b>	<b>Input is 1x32Amp</b>		<b>X</b>
<b>JMP-2</b>		<b>X</b>	
JMP-1	Input is 3x16Amp		X
JMP-2			X
JMP-3	Heat associated pump/ default set point	<b>Circulation Pump/100°F</b>	Pump 1/85°F
JMP-4	Pump 2 not installed Pump 3 not installed	X	
JMP-5		X	
JMP-4	Pump 2 is single speed Pump 3 not installed	X	
JMP-5			X
JMP-4	Pump 2 is dual speed Pump 3 not installed		X
JMP-5			X
<b>JMP-4</b>	<b>Pump 2 is single speed Pump 3 is single speed</b>		<b>X</b>
<b>JMP-5</b>		<b>X</b>	
JMP-6	Waterfall	<b>Installed</b>	Not Installed
JMP-7	Dynamic Lighting	<b>Installed</b>	Not Installed
JMP-8	Heater management	<b>Enabled (restricted)</b>	Disabled**

Default settings shown in **Bold**.

\*\* If jumper 8 is set to position 2, Heater management is disabled and heat is driven between P63 and P66.



# AFS GAS HEATER CONVERSION INSTRUCTIONS

Please read the following document if you want to learn how to heat up an Aquatic Fitness System with a gas heater:

In order to make the conversion, you need to purchase an AFS gas heater conversion kit from an authorized D1 dealer (part # 01512-0071)

- 1) Make sure that the GFCI is turned off
- 2) Locate the lower control (blue box) and open it



- 3) Attach the relay to the black shield in the Lower Control with two dots of silicone: one on the bottom and one on the side.



- 4) Move the heater management jumper to the right position (disabled). Jumper 7 for North American boards and jumper 8 for Export boards.



- 5) Disconnect the power wires from the electrical heater (Black, red, green and white cables) and secure the loose ends to a nearby ground stud.



- 6) Connect one wire jumper to P63 and the other wire jumper to P66. Connect the wire jumpers to the two unmarked terminals of the relay

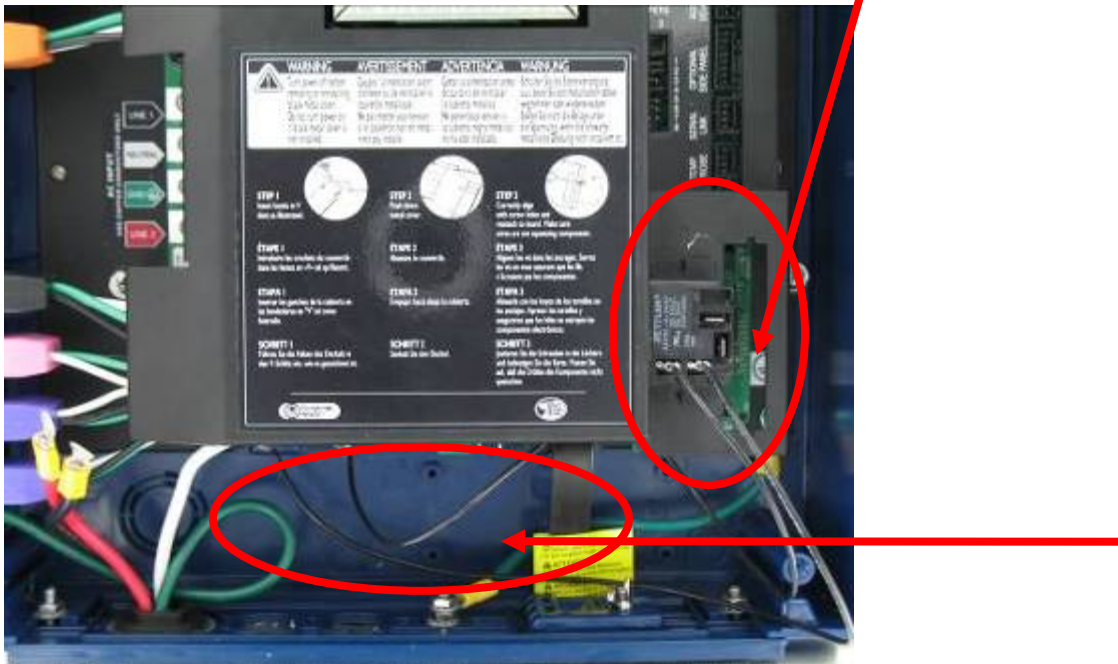

7) Connect the wires from the gas heater safety circuit to the relay terminals marked NO and COM

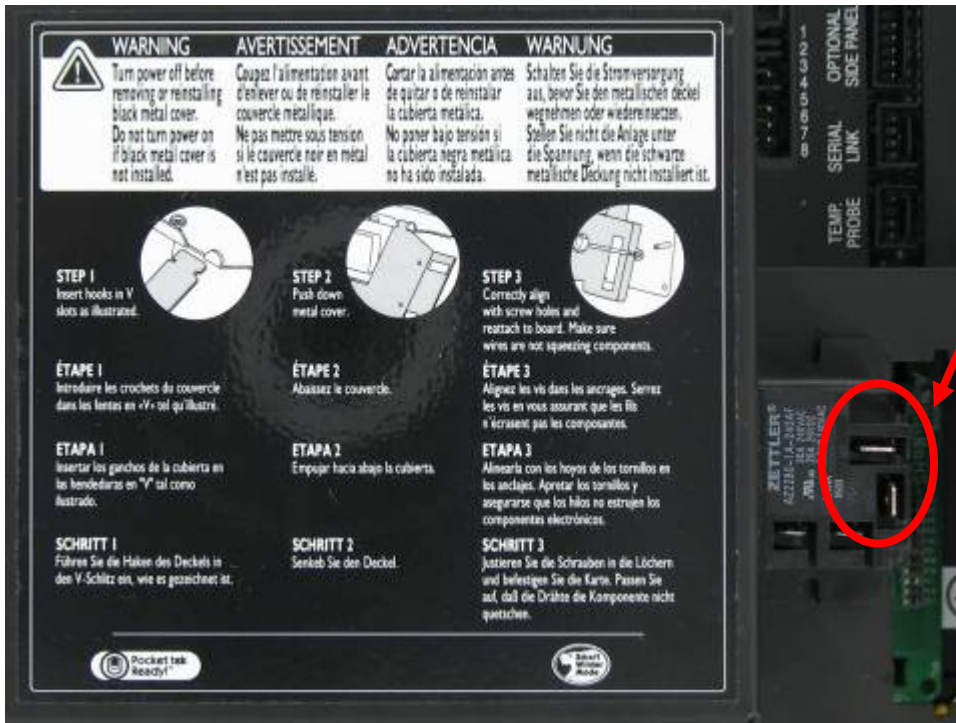

8) Cut off the 2" ends caps at pump 1 output and return. Connect to the heater plumbing.

