

OpenAir™

GCA Series Spring Return 160 lb-in Electronic Damper Actuators



Description

The OpenAir 24 Vac/dc spring return 160 lb-in (18 Nm) electronic actuator is designed for digital or analog control of building HVAC dampers.

Features

- Brushless DC motor technology with stall protection
- Bi-directional fail-safe spring return
- Patented self-centering shaft coupling
- Manual override
- 160 lb-in (18 Nm) torque
- 5° preload as shipped from factory
- Offset and span adjustment models available
- Models with independently adjustable dual auxiliary switches available
- UL and cUL listed; **CE** certified

Application

These actuators are designed for use in constant or variable air volume installations for the control of return air, mixed air, exhaust, and face and bypass dampers requiring up to 160 lb-in (18 Nm) torque. They are designed for applications that require the damper to return to a fail-safe position when there is a power failure.

Product Numbers

Table 1.

Product Number	Operating Voltage			Control			Cables		Built-in Control Options				
	24 Vac ± 20%	24 Vdc ± 10%	120 Vac ± 10%	0 to 10 Vdc	2 to 10 Vdc or 0 to 10 Vdc	Floating	2-position	Standard	Plenum	Position Feedback	Dual Auxiliary Switches	Signal Inversion	Offset 0 to 5 Vdc Span 2 to 30 Vdc
GCA121.1U	•	•					•	•					
GCA121.1P	•	•					•		•				
GCA126.1U	•	•					•	•			•		
GCA126.1P	•	•					•		•		•		
GCA221.1U			•				•	•					
GCA226.1U			•				•	•			•		
GCA131.1U	•	•				•		•					
GCA131.1P	•	•				•			•				
GCA132.1U	•	•				•		•		•			
GCA136.1U	•	•				•		•			•		
GCA136.1P	•	•				•			•		•		
GCA151.1U	•	•			•			•		•		•	
GCA151.1P	•	•			•				•	•		•	
GCA156.1U	•	•			•			•		•	•	•	
GCA156.1P	•	•			•				•	•	•	•	
GCA161.1U	•	•		•				•		•			
GCA161.1P	•	•		•					•	•			
GCA163.1U	•	•		•				•		•			•
GCA163.1P	•	•		•					•	•			•
GCA164.1U	•	•		•				•		•	•		•
GCA164.1P	•	•		•					•	•	•		•
GCA166.1U	•	•		•				•		•	•		
GCA166.1P	•	•		•					•	•	•		

Warning/Caution Notations

WARNING:		Personal injury/loss of life may occur if you do not perform a procedure as specified.
CAUTION:		Equipment damage may occur if you do not perform a procedure as specified.

Specifications

Ambient Conditions	Ambient temperature operation storage and transport	-25°F to 130°F (-32°C to 55°C) -40°F to 158°F (-40°C to 70°C)				
	Ambient humidity (non-condensing)	95% rh				
Agency Certification		UL listed to UL60730 (to replace UL873) cUL certified to Canadian Standard C22.2 No. 24-93				
CE Conformity	Electromagnetic compatibility (EMC) Immunity for all models, except GCA132.xx Immunity for GCA132.xx Emissions for all models	2004/108/EC EN61000-6-2 EN61000-6-1 EN61000-6-3				
Power Supply		GCA16x	GCA15x	GCA13x	GCA12x	GCA22x
		24 Vac ± 20% 24 Vdc ± 10%	24 Vac ± 20% 24 Vdc ± 10%	24 Vac ± 20% 24 Vdc ± 10%	24 Vac ± 20% 24 Vdc ± 10%	120 Vac ± 10% —
	Frequency	50/60 Hz	50/60 Hz	50/60 Hz	50/60 Hz	50/60 Hz
	Power Consumption					
	running	7 VA/5W	7 VA/5W	7 VA/5W	7 VA/5W	8 VA
	holding	5 VA/3W	5 VA/3W	5 VA/3W	5 VA/3W	6 VA
Control Signal		GCA16x	GCA15x	GCA13x	GCA12x	GCA22x
	Input Signal (Y-G0) voltage input	0 to 10 Vdc (max. 35 Vdc)	0 to 10 Vdc or 2 to 10 Vdc (max. 35 Vdc)	Floating	2-Position	2-Position
	input resistance	>100K ohms	>100K ohms	—	—	—
Feedback Signal		GCA16x	GCA15x	GCA13x	GCA12x	GCA22x
	Position output signal (U-G0) voltage output	0 to 10 Vdc	0 to 10 Vdc	0 to 1000 ohms <10 Ma (GCA 132x only) Load <1W	—	—
	maximum output current	±1 mA	+1 mA, -5 mA	—	—	—
Function	Running/spring return torque	Operating with 24 Vac Maximum torque 160 lb-in (18 Nm) <360 lb-in (40 Nm)				
	Runtime for 90° operating with motor closing (on power loss) with spring return	90 sec 15 seconds typical				
	NOTE: At -25°F, spring return is 142 lb-in (16 Nm).					
Equipment rating		Class 2, in accordance with UL/CSA				

**Specifications,
 Continued**

Mounting	Nominal angle of rotation	90°
	Maximum angular rotation	95°
	Shaft size	3/8-inch to 1-inch (8 mm to 25.6 mm) diameter
Auxiliary features	Minimum shaft length	1/4-inch to 5/8-inch (6 to 18 mm) square
	Control signal adjustment	3/4-inch (20 mm)
Dual auxiliary switches	Offset (start point)	0 Vdc to 5 Vdc
	Factory setting	0 Vdc
	Span	2 Vdc to 30 Vdc
	AC rating (Standard cable)	24 Vac to 250 Vac AC 6A resistive AC 2A FLA, 12 LRA
	AC rating (Plenum cable)	24 Vac AC 4A resistive AC 2A, FLA, 12 LRA
	DC rating (Standard/Plenum cable)	12 Vdc to 30 Vdc DC 2A
	Switch Range	
	Switch A	0 to 90° with 5° intervals
	Recommended range usage	0 to 45°
	Factory setting	5°
Switch B	0 to 90° with 5° intervals	
Recommended range usage	45° to 90°	
Factory setting	85°	
Switching hysteresis	2°	
Housing	Enclosure	NEMA 2, IP54 per EN 60 529 in vertical to horizontal 90° See Figure 17.
		NEMA 3R rated when installed with ASK75.1U Weather Shield in the vertical position. See Figure 18. See <i>Accessories</i> , Figure 9.
	Material	Die-cast aluminum alloy
	Gear lubrication	Silicone-free



WARNING:
 Apply only AC-line voltage from the same phase or only UL-Class 2 voltage to the switching outputs of both auxiliary switches A and B. Mixed operation is not permissible.

NOTE: With plenum cables, only UL-Class 2 voltage is permitted.

Miscellaneous	Pre-cabled connection	18 AWG
	Cable length	3 feet (0.9 m)
	Noise level	<45 dBA (running)
	Life cycle	Designed for over 60,000 full strokes and a minimum of 1.5 million repositions at rated torque and temperature.
	Dimensions	See Figure 31.
	Weight	4.85 lb (2.2 kg)

Actuator Components

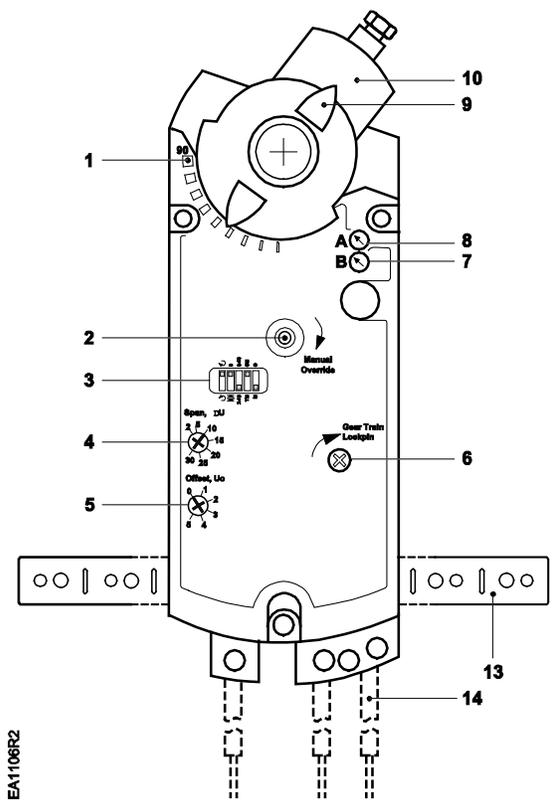
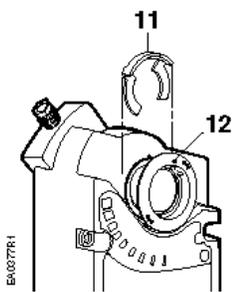

Legend

1. Positioning scale for angle of rotation
2. Manual override wrench opening and direction of rotation arrow
3. DIP switches
4. Span adjustment
5. Offset (start point) adjustment
6. Gear train lock pin
7. Auxiliary switch B
8. Auxiliary switch A
9. Position indicator
10. Self-centering shaft adapter
11. Shaft adapter locking clip
12. Position indicator adapter
13. Mounting bracket
14. Connection cables

Figure 1. Modulating GCA Actuator.

NOTE: Not all features are on all models. See Table 1 for a listing of features per model.

Accessories

NOTE: The control signal adjustment cannot be added in the field. Order the product number that includes the option(s).

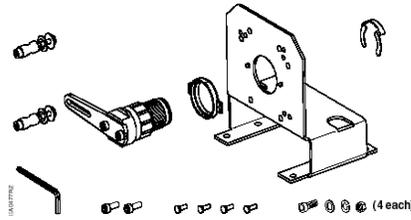

Figure 2. Floor Mount Kit.

ASK71.1U: Allows foot mounting of OpenAir actuators. Should be used for in-the-air stream applications, and generally, anywhere a foot-mounted actuator can be mounted. Kit contains:

- Crank arm for changing angular rotation into a linear stroke.
- Support bearing ring to minimize side loading on the actuator's output bearing.
- Mounting bracket.
- Required mounting fasteners.

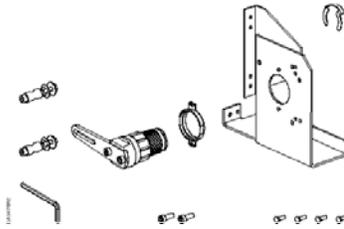

Figure 3. Frame Mount Kit.

ASK71.2U: Allows mounting OpenAir actuators directly to damper frame. Should be used with louvers and vents and in applications where floor mount kit is not possible. Kit contains:

- Crank arm for changing angular rotation into a linear stroke.
- Support bearing ring to minimize side loading on the actuator's output bearing.
- Mounting bracket.
- Required mounting fasteners.



Figure 4. Crank Arm Kit.

ASK71.3: Allows direct-coupled actuator to provide an auxiliary linear drive. Crank arm kit can be used to simultaneously drive a set of opposing or adjacent dampers with single actuator. Kit includes:

- Crank arm to attach to the splined hub of the shaft adapter.
- Other required mounting fasteners.

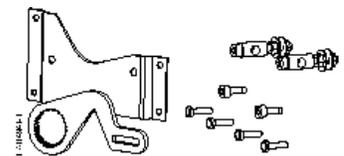

Figure 5. Crank Arm Kit with Mounting Bracket.

ASK71.4: Allows economical mounting of OpenAir actuator to a variety of surfaces. Kit should be used in applications where the actuator can be rigid-surface mounted and linear stroke output is required. Kit includes:

- Crank arm to attach to the splined hub of the shaft adapter.
- Mounting bracket.
- Other required mounting fasteners.

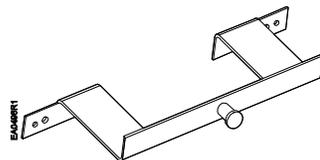

Figure 6. Tandem Mount Bracket.

ASK73.1: Bracket provides an extended anti-rotation pin allowing two OpenAir actuators to directly drive a single damper shaft. Tandem mounting bracket for two GCA 2-position and floating control actuators mounted on the same side of the damper shaft.

**Accessories,
Continued**

Figure 7. Tandem Mount Bracket.

ASK73.2U: Bracket provides an extended anti-rotation pin allowing two OpenAir modulating actuators to directly drive a single damper shaft. Tandem mounting bracket for two GCA16x (standard to 10 Vdc modulating control) Series Actuators mounted on the same side of the damper shaft.

NOTE: For applications requiring single damper shaft operation by up to four GCA modulating control signal actuators mounted on each side of the damper shaft, use the GCA15x Series Actuator with Master/Slave mode operation selected.

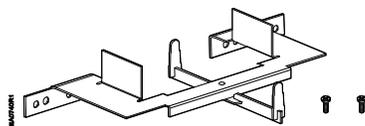
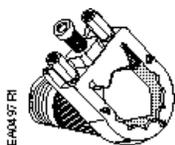

Figure 8. Special Shaft Adapter.

ASK74.1U: Shaft adapter will attach to a 1.05-inch (26.6 mm) diameter shaft; the standard self-centering adapter will accept up to a one-inch (25.4 mm) diameter shaft.

- Adapter can be used for coupling to slightly oversized one-inch (25.4 mm) jackshafts.
- Shaft adapter is 13/16-inches (20 mm) shorter than the height of the self-centering shaft adapter.

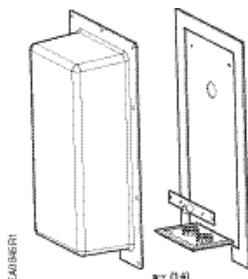

Figure 9. NEMA 3R Weather Shield.

ASK75.1U: GCA Actuators are UL listed to meet NEMA 3R requirements (a degree of protection against rain, sleet, snow and damage from external ice formation) when installed with ASK75.1U Weather Shield and outdoor-rated conduit fittings in the vertical position.

For dimensions, see Figure 29.

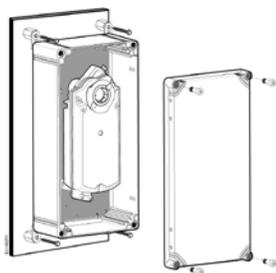

Figure 10. NEMA Type 4X Weather Shield.

ASK75.7U: GCA Actuators are UL listed to meet NEMA Type 4X requirements (a degree of protection against falling dirt, rain, sleet, snow, windblown dust, splashing water, hose-directed water, corrosion, and damage from external ice formation) when installed with an ASK75.7U Weather Shield and outdoor-rated conduit fittings. This weather shield may be mounted in any orientation.

For dimensions, see Figure 30.

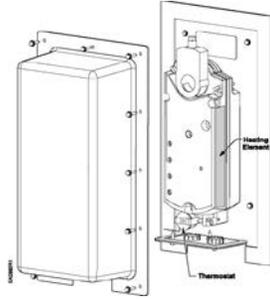

Figure 11. Heater/Weather Shield Assembly.

985-106: Provides protection for GIB, GBB and GCA OpenAir actuators down to temperatures of -58°F (-50°C). Assembly includes:

- Weather Shield
- Heater Kit



Figure 12. 499 Ohm Resistor Assembly Kit.

985-124: Used for converting a 4 to 20 mA controller output signal into a 2 to 10 Vdc actuator signal.

Service Parts

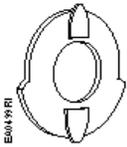

985-003
Position Indicators
(10/pkg.)

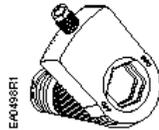

985-004
Standard Shaft Adapter.



985-006
Anti-rotation (Mounting)
Bracket.



985-008
Conduit Adapter,
1/2-inch (12 mm)
for 1/2-inch NPT
Connector.

Figure 13. Orderable Service Parts.

Operation

GCA12x and GCA22x: 2-Position Control

When power is applied, the actuator coupling moves toward the open position 90°.

GCA13x: Floating Control

A floating control signal controls the damper actuator. The actuator's angle of rotation is proportional to the length of time the signal is applied. A 24 Vac/dc control signal to Y1 causes the actuator coupling to rotate clockwise. A 24 Vac/dc control signal to Y2 causes the actuator coupling to rotate counterclockwise.

With no control voltage, the damper actuator holds its position.

GCA16x and GCA15x: Modulating Control

A continuous 0 to 10 Vdc or 2 to 10 Vdc signal from a controller to wire Y operates the damper actuator. The angle of rotation is proportional (or inverse proportional) to the control signal. A 0 to 10 Vdc position feedback output signal between wires U and G0 (system neutral) monitors the position of the damper actuator.

In the event of a power failure or when the operating voltage is shut off, all actuator models will return to the 0 position.

In the event of a blockage in a damper, actuators are overload protected over the full range to prevent damage to the actuators.

Life expectancy

An improperly tuned loop will cause excessive repositioning that will shorten the life of the actuator.

Control Signal Adjustment

GCA 163 and GCA164

The offset (start point) and span of the control signal can be adjusted. The offset, U_o , can be adjusted between 0 to 5 Vdc. The span, ΔU , can be adjusted between 2 to 30 Vdc.

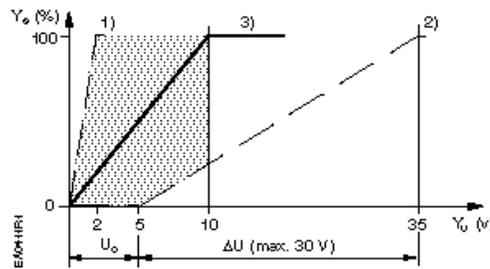

- Ys Mechanical positioning range (100% = angle of rotation 90°)
- Yu Control signal
- Uo Offset (start point)
- ΔU Span
- $U_o = 0V, \Delta U = 2V$

The minimum working range for $Y_s = 100\%$

1. $U_o = 5V, \Delta U = 30V$ The maximum working range for $Y_s = 100\%$
2. $U_o = 0V, \Delta U \approx 10V$ Factory setting

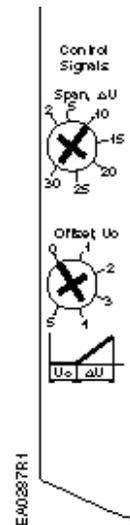

Setting for 10V span
 0V offset

Figure 14. The Minimum and Maximum Control Signal Adjustment.

Example:

Open the actuator from 0% to 50% (45°) using a control signal of $U_{min} = 2V$ to $U_{max} = 10V$.

Calculating the value of ΔU :

$$\Delta U = \frac{100 [\%] (U_{max} - U_{min})}{\text{Working angle of rotation in } \%} = \frac{100 \times (10 - 2)}{50} = 16V$$

Settings

$U_0 = 2Y; \Delta U = 16V$

U_{min} = minimum control signal
 U_{max} = maximum control signal

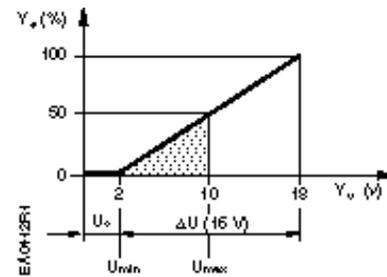
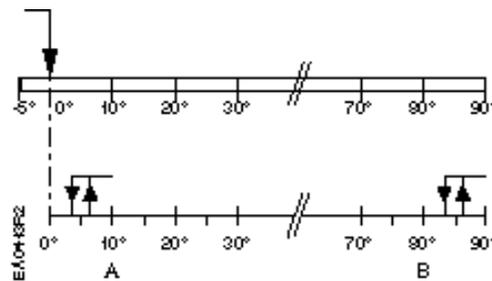

Figure 15. Example.

Dual Auxiliary Switch GCAxx4, GCAxx6



Actuator rotary range with the shaft adapter mounted at position "0".

Setting range for switches A and B

Setting interval: 5°

Switching hysteresis: 2°

To change the settings of A and B:

1. Make sure the actuator is in the "0", fail-safe position. The scale is valid only in the "0" position.
2. Use a flat-blade screwdriver to turn the switch adjustment dials to the desired setting at which a signal is to be given.

Factory setting:
 Switch A 5°
 Switch B 85°

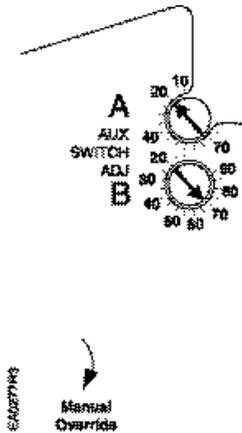

Figure 16. Dual Auxiliary Switch Dials.

NOTE: For GCA15x actuators with signal inversion switch set to Inverse Acting, 90° corresponds to either a 0 to 10 Vdc or a 2 to 10 Vdc. Vdc input signal depends on the input signal selection.

Sizing

The type of actuator required depends on several factors.

1. Obtain damper torque ratings (ft-lb/ft² or Nm/m²) from the damper manufacturer.
2. Determine the area of the damper.
3. Calculate the total torque required to move the damper:

$$\text{Total Torque} = \frac{\text{Torque Rating} \times \text{Damper Area}}{\text{SF}^1}$$

¹ Safety Factor: When calculating the total torque required, a safety factor should be included for unaccountable variables such as slight misalignments, aging of the damper, etc. A suggested safety factor is 0.80.

4. Select the actuator type using Table 2.

NOTE: Mechanically coupled actuators must all be of the exact same type except for the dual auxiliary switches and feedback potentiometer options. Make sure to use the correct tandem-mounting bracket. See Table 2.

Table 2.

Sizing	
Total Torque	Actuator
<62 lb-in (7 Nm)	GMA
>62 lb-in <160 lb-in (>7 Nm <18 Nm)	GCA
>160 lb-in <320 lb-in (>18 Nm <36 Nm)	<p>ASK73.2U*: Tandem mounting bracket with any combination of two GCA16x (standard 0 to 10 Vdc modulating control) actuators mounted on the same side of the damper shaft.</p> <p>ASK73.1*: Tandem mounting bracket for two GCA 2-position and floating control actuators that are mounted on the same side of the damper shaft.</p> <p>NOTE: For applications requiring single damper shaft operation by up to four GCA modulating control signal actuators mounted on each side of the damper shaft, use the GCA15x Series Actuator with Master/Slave mode operation selected. See Figure 22 for master/slave DIP switch settings, and Figure 27 for wiring of this configuration.</p>

*Tandem application tested for up to four actuators. Each bracket mounts two actuators.

Mounting and Installation

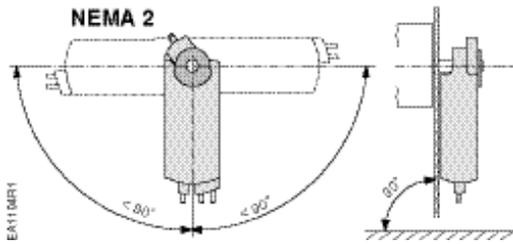

Figure 17.
Acceptable NEMA 2, IP54 per EN 60 529
Mounting Positions.

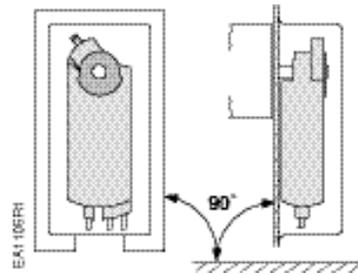

Figure 18.
Only Acceptable Mounting Position for NEMA Type 3R
Rating Using ASK75.1U Weather Shield.

The GCA actuator is UL listed to meet NEMA Type 3R requirements (a degree of protection against rain, sleet, and damage from external ice formation) when installed with the Weather Shield (product number ASK75.1U) and outdoor-rated conduit fittings. Actuator must be in the vertical position.

- The shaft adapter and the position indicator can be mounted on either side of the actuator. The actuator mounting orientation and shaft length determine how they will be mounted on the actuator.
- The minimum damper drive shaft length is 3/4-inch (20 mm).
- See *Specifications* for the minimum and maximum damper shaft dimensions.
- The actuator is shipped from the factory with a 5° preload enabling tight close off of the damper in power-fail-close applications.
- A mounting bracket is included with the actuator.
- The shaft adapter and mounting parts are shipped in a separate container with the actuator.
- See the detailed mounting instructions included with each actuator.

Flip the actuator to select either clockwise or counterclockwise fail-safe rotation of the damper shaft. Follow Steps 1, 2, and 3 of Table 3 to determine the correct actuator mounting orientation.

Table 3. Actuator Mounting Orientation and Damper Control.

EA1039R2	Determining the Actuator Mounting Orientation	① Damper Type					
		② Power Fail Spring Return Position	Close	Open	Close	Open	
		③ Actuator Mounting Orientation					
EA1040R2	Modulating Control	GCA15x Using 2 to 10	$Y = 10V \Omega$	Open	Close	Open	Close
			$Y = 2V \Omega$	Open	Close	Open	Close
		GCA15x or GCA16x Using 0 to 10	$Y = 10V$ (or $Y = U_0 + \Delta U$)	Open	Close	Open	Close
			$Y = 2V \Omega$	Close	Open	Close	Open
			$Y = 10V \Omega$	Close	Open	Close	Open
EA1039R1	3-Position	GCA13x	Y1	Open	Close	Open	Close
			Y2	Open	Close	Open	Close
			Y1	Close	Open	Close	Open
			Y2	Close	Open	Close	Open
EA1039R1	2-Position	GCA12x	Power On	Open	Close	Open	Close
		GCA22x		Open	Close	Open	Close

Manual override

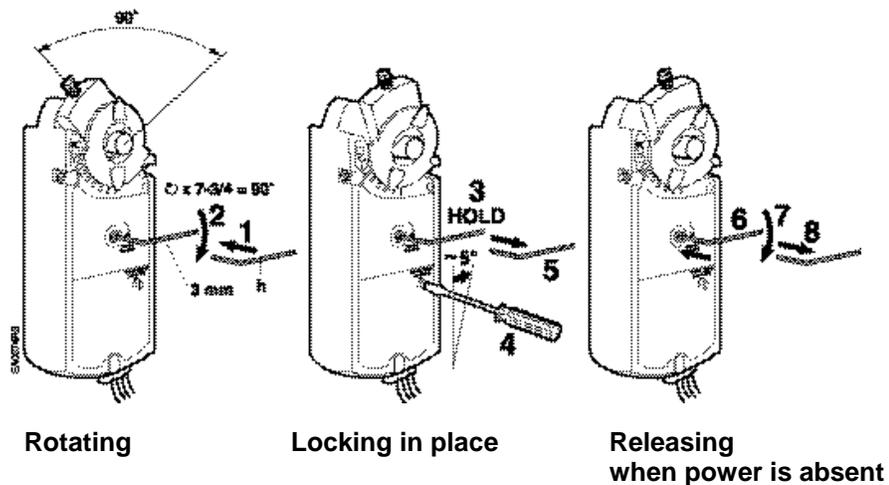

Figure 19. Manual Override.

Always turn the key in the direction of the arrow.



CAUTION:

When engaging the gear train lock pin, be careful to turn only about five degrees until you hear a click or meet slight resistance. Turning too far will strip the lock pin.

To release manual override, either restore power and send a control signal; or when power is absent, insert the 3 mm hex key in the override opening, turn the key in the direction of the arrow and remove the key.

Mechanical Range Adjustment

The angular rotation is adjustable between 0 and 90° at five-degree intervals. To limit the range of shaft movement, remove the locking clip and self-adjusting shaft adapter. Rotate the damper blade shaft to its failed position. Rotate the shaft coupling to the desired position. Insert the shaft adapter into the actuator and fasten it with the locking clip. See Figure 20.

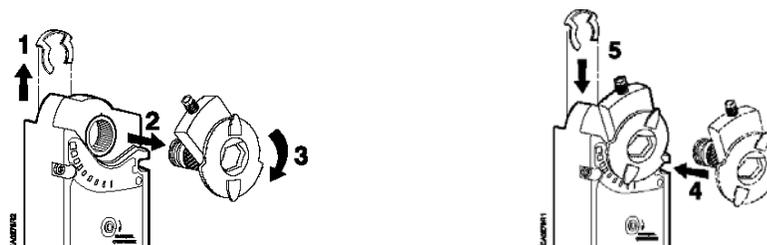

Figure 20. Mechanical Range Adjustment.

Wiring

All wiring must conform to NEC and local codes and regulations.

Use earth ground isolating step-down Class 2 transformers. Do not use autotransformers.

The maximum rating for a Class 2 step-down transformer is 100 VA. Determine the supply transformer rating by summing the VA ratings of all actuators and other components used. It is recommended that one transformer does not power more than nine actuators (or 80% of its VA).



WARNING:

Mixed switch operation is not permitted to the switching outputs of both auxiliary switches (A and B).

Either AC line voltage from the same phase must be applied to all six outputs of the dual auxiliary switches, or UL-Class 2 voltage must be applied to all six outputs.

NOTE: With plenum cables, only UL-Class 2 voltage is permitted.

Implementation of DIP Switch Features (GCA15x Only)

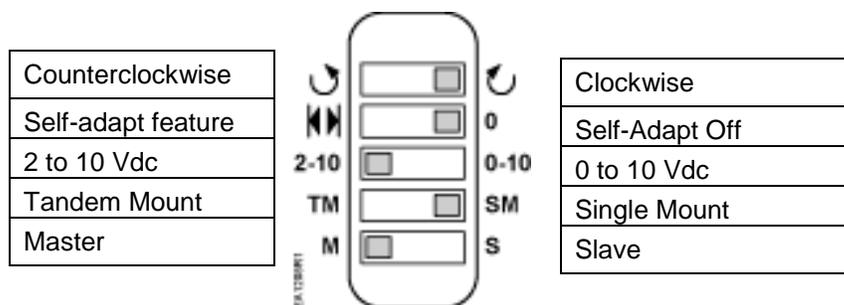

Figure 21. GCA15x Series.

Self-Adapt Feature

The factory setting is 0 (OFF).

When mechanical angle of rotation is limited, the self-adapt switch may be turned ON so that the limited range will become the new 0 to 100% for the actuator logic. In this case, 0 to 100% is not equal to 90°



CAUTION:

When turning the self-adaptive feature on or after a software reset with the feature on, the actuator will enter a three-minute calibration cycle as the actuator adjusts to the rotation limits of the system. A software reset happens after power on or may be caused by electrostatic discharge (ESD) at levels of 2kV and above.

The position output signal U is not influenced by the self-adapt function. The 0 to 10V feedback signal U is always proportional to 0° to 90° (or 90° to 0°).

**GCA15x.1x
(0 to 10 Vdc or
2 to 10 Vdc)
for Tandem
Application
(Master/Slave)**

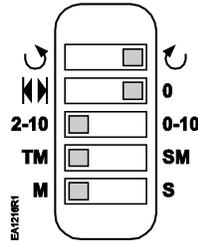

Figure 22. Tandem Application DIP Switch Settings.

- After setting the 4th DIP switch for TM (tandem mount) on all actuators used in the tandem application, one actuator must be identified as the Master by selecting the "M" on the 5th DIP switch.
- The rest of the actuators used in the application must have the "S" (slave) set on the 5th DIP switch.
- Connect all the 2 (black) Neutral wires and connect them to the power supply.
- Connect all the 1 (red) Supply wires together and connect them to the power supply.
- The Output Signal 9 (pink) wire, identified as the Master actuator, needs to be connected to all the Control Signal Wires 8 (gray) of the slave actuators used in the tandem application.

Wire Designations

Each wire has the standard symbol printed on it. See Table 4.

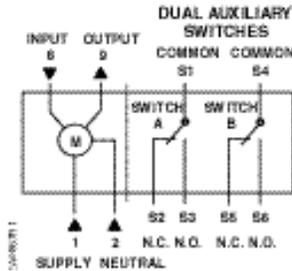

Figure 23. GCA15x, GCA16x, Modulating Control.

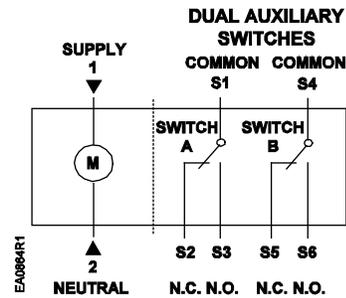

Figure 24. GCA12x, 2-Position Control.

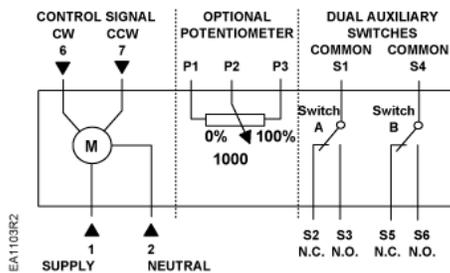

Figure 25. GCA13x, Floating Control.

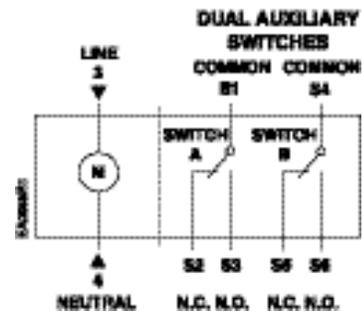

Figure 26. GCA22x, 2-Position Control.

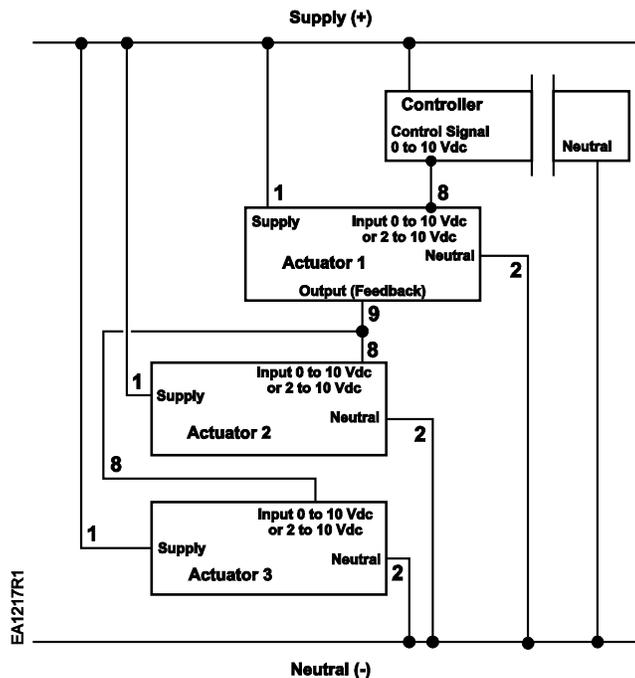

Figure 27. GCA15x.1x for Tandem Application (Master/Slave).

Table 4. Wire Designations.

Standard Symbol	Function	Terminal Designations	Color	
			Standard	Plenum
1	Supply (SP)	G	Red	Red
2	Neutral (SN)	G0	Black	Black
3	Line (120 Vac)	L	Black	Black
4	Neutral (120 Vac)	N	White	White
6	Control Signal clockwise (GCA13x)	Y1	Violet	Violet
7	Control Signal counterclockwise (GCA13x)	Y2	Orange	Orange
8	Input signal: 0 to 10 Vdc (GCA16x) or 2 to 10 Vdc (GCA15x)	Y	Gray	Gray
9	Position output: 0 to 10 Vdc (GCA15x & GCA16x)	U	Pink	Pink
S1	Switch A Common	Q11	Gray/red	Gray/red
S2	Switch A NC	Q12	Gray/blue	Gray/blue
S3	Switch A NO	Q14	Gray/pink	Gray/pink
S4	Switch B Common	Q21	Black/red	Black/red
S5	Switch B NC	Q22	Black/blue	Black/blue
S6	Switch B NO	Q24	Black/pink	Black/pink
P1	Feedback Potentiometer 0 to 100% P1 – P2	A	White/red	Black
P2	Feedback Potentiometer – Common	B	White/blue	Black
P3	Feedback Potentiometer 100 to 0% P3 – P2	C	White/pink	Black

**Start-Up/
 Commissioning
 GCA12x
 (24 Vac/dc)
 GCA22x (120 Vac)**

1. Check Operation:
 - a. Switch on Vac/dc power.
 - b. Allow the actuator shaft coupling to rotate from 0 to 90°.
 - c. Switch off Vac/dc power.
 The actuator shaft coupling will return to the "0" position.
2. Check Spring Return:
 - a. Switch on Vac power.
 - b. Allow the actuator shaft coupling to rotate halfway.
 - c. Switch off Vac power.
 The spring returns the actuator shaft coupling to the fail "0" position.
3. Check the Auxiliary Switch A:
 - a. Set the DMM dial to ohms (resistance) or continuity check.
 - b. Connect wires S1 and S3 to the DMM.
 The DMM should indicate an open circuit or no resistance.
 - c. Switch on Vac power.
 The DMM should indicate contact closure as the actuator shaft coupling reaches the setting of switch A.
 - d. Connect wires S1 and S2 to the DMM.
 The DMM should indicate open circuit or no resistance.
 - e. Switch off Vac power.
 The DMM should indicate contact closure as the actuator shaft coupling reaches the setting of switch A.

**Start-Up/
Commissioning
GCA12x
(24 Vac/dc)
GCA22x (120 Vac)
(Continued)**

4. Check the Auxiliary Switch B:
 - a. Set the DMM dial to ohms (resistance) or continuity check.
 - b. Connect wires S4 and S6 to the DMM.
The DMM should indicate open circuit or no resistance.
 - c. Switch on Vac power.
The DMM should indicate contact closure as the actuator shaft coupling reaches the setting of switch B.
 - d. Connect wires S4 and S5 to the DMM.
The DMM should indicate open circuit or no resistance.
 - e. Switch off Vac power.
The DMM should indicate contact closure as the actuator shaft coupling reaches the setting of switch B.
-

GCA13x

1. Check Operation:
 - a. Connect wires 1 (red) and 2 (black) to 24 Vdc power supply.
 - b. Apply a control signal (24 Vac/dc) to wire 6 (violet).
 - c. Allow the actuator shaft coupling to rotate from 0 to 90°.
 - d. Stop applying a control signal to wire 6 (violet).
 - e. Apply a control signal (24 Vac/dc) to wire 7 (orange).
 - f. Allow the actuator shaft coupling to rotate from 90 to 0°.

 2. Check Spring Return:
 - a. Apply a control signal (24 Vac/dc) to wire 6 (violet).
 - b. Allow the actuator shaft coupling to rotate half way.
 - c. Disconnect wire 1 (red).
 - d. The spring returns the actuator shaft coupling to the fail "0" position.
 - e. Connect wire 1 (red). The actuator shaft coupling begins to move.

 3. Check Feedback:
 - a. Set the digital multimeter (DMM) dial to ohms.
 - b. Connect wires P1 and P2 to the DMM. The DMM should indicate a resistive value.
 - c. Apply a control signal (24 Vac/dc) to wire 6 (violet).
The reading of the DMM should increase.
 - d. Stop applying a control signal to wire 6 (violet).
 - e. Connect wires P2 and P3 to the DMM. The DMM should indicate a resistive value.
 - f. Apply a control signal (24 Vac/dc) to wire 7 (orange).
The reading of the DMM should increase.

 4. Check the Auxiliary Switch A:
 - a. Set the DMM dial to ohms (resistance) or continuity check.
 - b. Connect wires S1 and S3 to DMM. The DMM should indicate an open circuit or no resistance.
 - c. Apply a control signal (24 Vac/dc) to wire 6 (violet).
The DMM should indicate contact closure as the actuator shaft coupling reaches the setting of switch A.
 - d. Stop applying a control signal to wire 6 (violet).
 - e. Connect wires S1 and S2 to the DMM. The DMM should indicate an open circuit or no resistance.
 - f. Apply a control signal (24 Vac/dc) to wire 7 (orange).
The DMM should indicate contact closure as the actuator actuator-shaft coupling reaches the setting of switch A.
-

Start-Up/ Commissioning

GCA13x (Continued)

-
5. Check the Auxiliary Switch B:
 - a. Set the DMM dial to ohms (resistance) or continuity check.
 - b. Connect wires S4 and S6 to the DMM. The DMM should indicate an open circuit or no resistance.
 - c. Apply a control signal (24 Vac/dc) to wire 6 (violet).
The DMM should indicate contact closure as the actuator actuator-shaft coupling reaches the setting of switch B.
 - d. Stop applying a control signal to wire 6 (violet).
 - e. Connect wires S4 and S5 to the DMM. The DMM should indicate an open circuit or no resistance.
 - f. Apply a control signal (24 Vac/dc) to wire 7 (orange).
The DMM should indicate contact closure as the actuator actuator-shaft coupling reaches the setting of switch B.
-

GCA15x GCA16x

1. Check Operation:
 - a. Connect wires 1 (red) and 2 (black) to the 24 Vac or 24 Vdc power supply.
NOTE: With no input signal present, the GCA15x actuator with signal inversion switch set to Inverse Acting will start driving towards 90°.
 - b. Use a Digital Multimeter (DDM) and set the dial to Vdc for the actuator input signal.
 - c. Connect wires 2 (black) and 8 (gray) to the DMM.
 - d. Apply to input signal wire 8 (gray):
 $Y = 10 \text{ Vdc}$ or $Y = U_o + \Delta U$ (GCA16x)
 $Y = 10 \text{ Vdc}$ (GCA15x in direct-acting mode)
 $Y = 2 \text{ Vdc}$ (GCA15x in inverse-acting mode)
 - e. Allow the actuator shaft coupling to rotate from 0 to 90.
 - f. Apply to input signal wire 8 (gray):
 $Y = 0 \text{ Vdc}$ or $Y = U_o$ (GCA16x)
 $Y = 2 \text{ Vdc}$ (GCA15x in direct acting mode)
 $Y = 10 \text{ Vdc}$ (GCA15x in inverse acting mode)

The shaft coupling returns to the "0" position.

2. Check Spring Return:
 - a. Set the DMM dial to Vdc.
 - b. Connect wires 2 (black) and 8 (gray) to the DMM.
 - c. Apply to input signal wire 8 (gray):
 $Y = 5 \text{ Vdc}$ or $Y = U_o + 1/2 \Delta U$ (GCA16x)
 $Y = 6 \text{ Vdc}$ (GCA15x)
 - d. Allow the actuator shaft coupling to rotate halfway.
 - e. Disconnect wire 1 (red).
The spring returns the actuator shaft coupling to the fail "0" position.
 - f. Connect wire 1 (red) and the actuator moves.
-

3. Check Feedback:
 - a. Set the DMM dial to Vdc.
 - b. Attach wires 2 (black) and 9 (pink) to the DMM.
 - c. Apply the input signal as in *Step 1d*, to wire 8 (gray).
The reading at the DMM should increase (decrease for GCA15x in inverse acting mode).
 - d. Apply the input signal as in *Step 1f*, to wire 8 (gray).
The reading at the DMM should decrease (increase for GCA15x in inverse acting mode) and the actuator shaft coupling returns to the fail "0" position.
-

**Start-Up
 Commissioning**

**GCA15x
 GCA16x
 (Continued)**

4. Check the Auxiliary Switch A:
 - a. Set the DMM dial to ohms (resistance) or continuity check.
 - b. Connect wires S1 and S3 to the DMM. The DMM should indicate open circuit or no resistance.
 - c. Apply the input signal as in *Step 1d*, to wire 8 (gray).
 The DMM should indicate contact closure as the actuator shaft coupling reaches the setting of switch A.
 - d. Connect wires S1 and S2 to the DMM. The DMM should indicate open circuit or no resistance.
 - e. Apply the input signal as in *Step 1f*, to wire 8 (gray).
 The DMM should indicate contact closure as the actuator shaft coupling reaches the setting of switch A.

5. Check the Auxiliary Switch B:
 - a. Set the DMM dial to ohms (resistance) or continuity check.
 - b. Connect wires S4 and S6 to the DMM. The DMM should indicate open circuit or no resistance.
 - c. Apply the input signal as in *Step 1d*, to wire 8 (gray).
 The DMM should indicate contact closure as the actuator shaft coupling reaches the setting of switch B.
 - d. Connect wires S4 and S5 to the DMM. The DMM should indicate open circuit or no resistance.
 - e. Apply the input signal as in *Step 1f*, to wire 8 (gray).
 The DMM should indicate contact closure as the actuator shaft coupling reaches the setting of switch B.

**Special
 Application**

Modulating 4 to 20 mA control with GCA15x and an external 499-ohm resistor (985-124, See Accessories).

NOTE: 985-124 is provided with the GCA15x actuator.

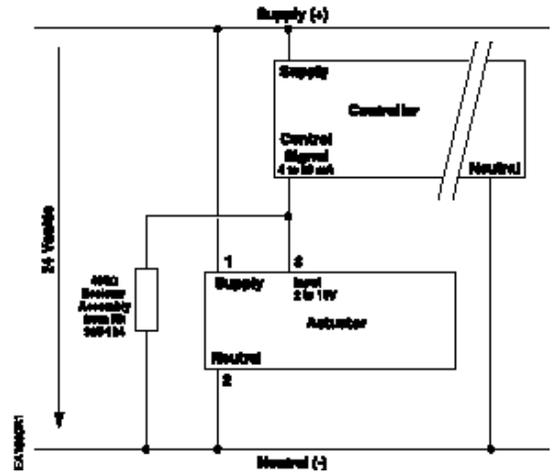

Figure 28.
**Wiring Diagram for Converting
 4 to 20 mA into 2 to 10 Vdc.**

Service



WARNING:

Do not open the actuator. If the actuator is inoperative, replace the unit.

Troubleshooting



WARNING:

To avoid injury or loss of life, pay attention to any hazardous voltage (for example, 120 Vac) when performing checks.

- Check that wires are connected correctly.
- Check that offset (start point) and span are set correctly, if used.
- Use a Digital Multimeter (DMM) to verify that the operating voltage is within range.
- If the actuator is not working, check the damper for blockage. If blocked, remove the obstacle and cycle the actuator power off and on. The actuator should resume normal operating mode.

Dimensions

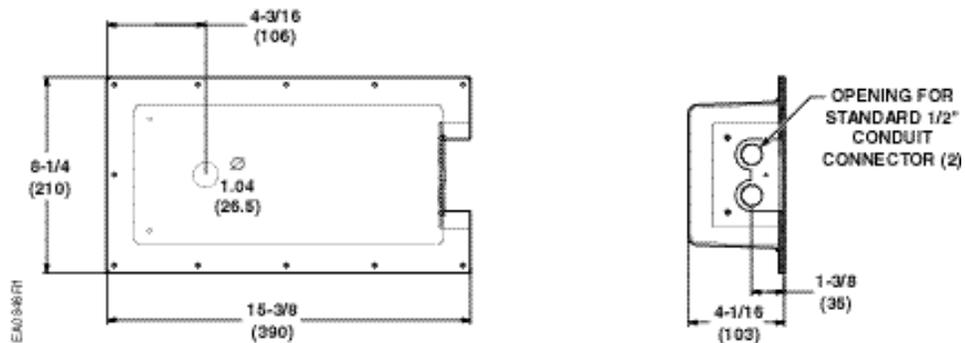

Figure 29. Dimensions of the ASK75.1U Weather Shield in Inches (Millimeters).

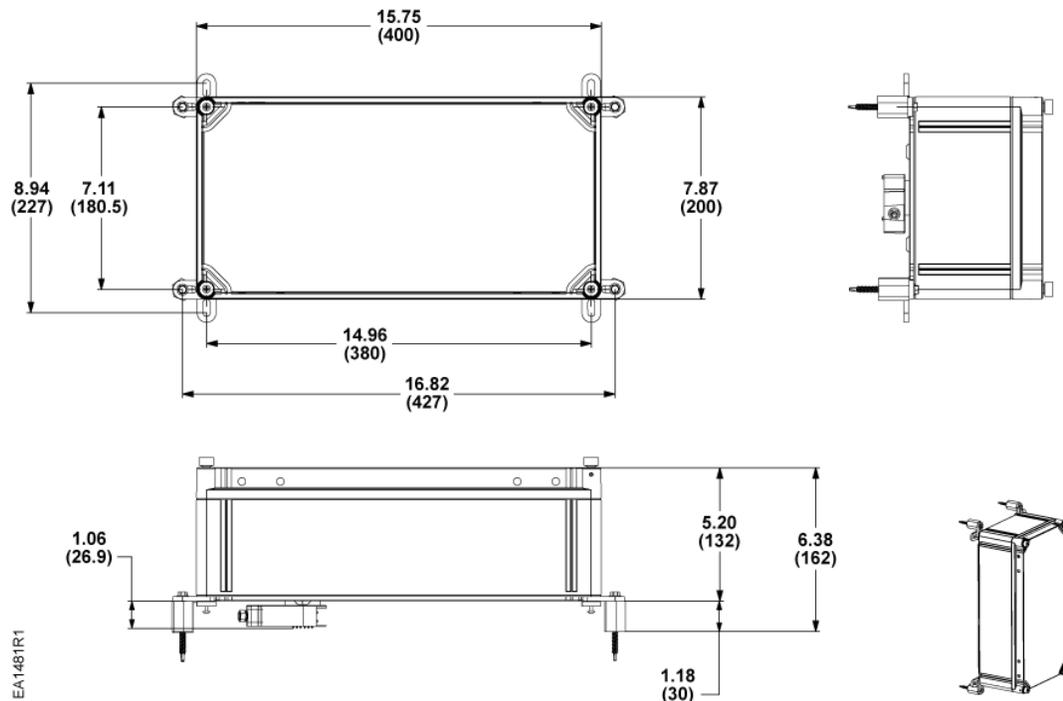

Figure 30. Dimensions of the ASK75.7U Weather Shield in Inches (Millimeters).

Dimensions, Continued

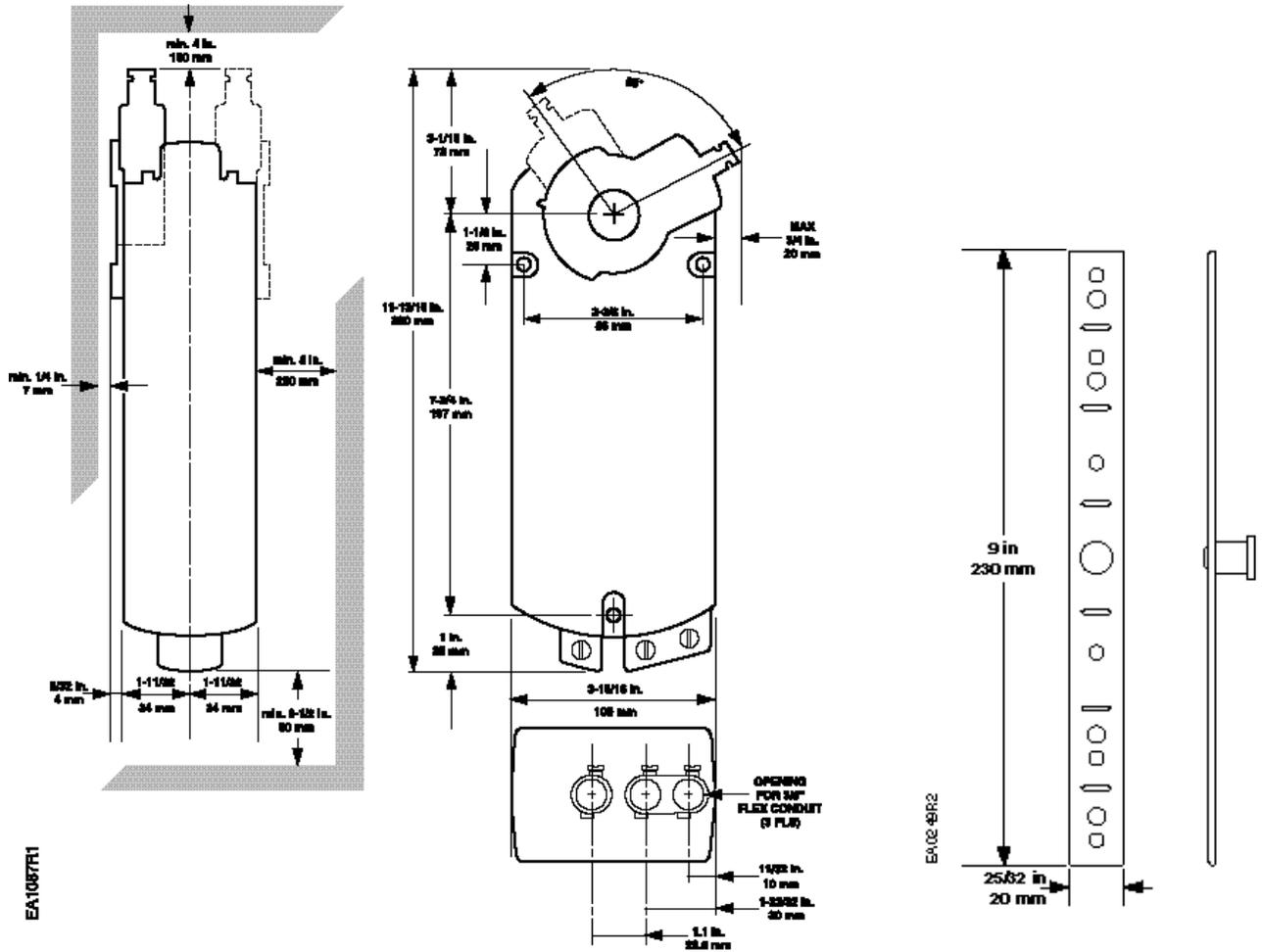

Figure 31. Dimensions of the GCA Actuator and Mounting Bracket in Inches (Millimeters).

Information in this publication is based on current specifications. The company reserves the right to make changes in specifications and models as design improvements are introduced. OpenAir is a trademark of Siemens Schweiz AG. Other product or company names mentioned herein may be the trademarks of their respective owners. © 2014 Siemens Industry, Inc.