



Radio | CD | MP3 | WMA



Toronto 400 BT

7 649 035 110 / 7 649 036 010



www.blaupunkt.com

Bedienungs- und Einbauanleitung
Operating and installation instructions
Mode d'emploi et de montage
Istruzioni d'uso e di installazione
Gebruiksaanwijzing en inbouwhandleiding
Bruks- och monteringsanvisning
Instrucciones de manejo e instalación
Instruções de serviço e de montagem
Betjenings- og monteringsvejledning
Instrukcja obsługi i montażowa
Návod k obsluze a k montáži
Käyttö- ja asennusohje
Kezelési és beszerelési útmutató
Инструкция по эксплуатации и установке
Οδηγίες τοποθέτησης και χρήσης

 **BLAUPUNKT**

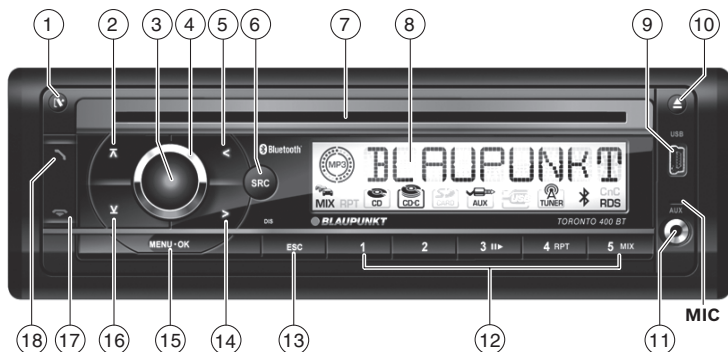

- ① **🔒** button
Unlock the detachable control panel
- ② **⏏** button
In the menu: Call up menu item
Radio mode: Select memory bank
MP3/WMA/C'n'C/CD changer mode: Change to next folder / CD
- ③ **⏻** button
Short press: Switch on car sound system
In operation: Mute car sound system (Mute)
Long press: Switch off car sound system
- ④ Volume control
- ⑤ **⏪** button
In the menu: Change settings
Radio mode: Adjust the stations
Other operating modes: Track selection
- ⑥ **SRC** button
Selecting an audio source
- ⑦ CD tray
- ⑧ Display
- ⑨ USB port
- ⑩ **⏴** button (Eject)
Eject a CD
- ⑪ Front AUX-IN socket
- ⑫ Keys **1 - 5**
- ⑬ **DIS/ESC** button
In the menu: Exit menu
In operation: Switch display
- ⑭ **➤** button
In the menu: Change settings
Radio mode: Adjust the stations
Other operating modes: Track selection
- ⑮ **MENU-OK** button
Short press: Call up menu, confirm settings
Long press: Start scan function
- ⑯ **⏩** button
In the menu: Call up menu item
Radio mode: Select memory bank
MP3/WMA/C'n'C/CD changer mode: Change to previous folder / CD
- ⑰ **📞** button
Ending/rejecting a phone call
- ⑱ **📞** button
Answering a call, speed dial

Safety notes	29	Playing tracks in random order	38
Symbols used	29	Repeatedly playing individual tracks, CDs or directories	39
Road safety	29	Configuring the display.....	39
General safety notes	29	Bluetooth®	39
Declaration of conformity	29	Bluetooth® menu	40
Cleaning notes	30	Registering and connecting a device.....	40
Disposal notes	30	Telephone functions	41
Scope of delivery	30	Bluetooth® streaming mode	42
Optional equipment (not part of the scope of delivery)	30	Additional functions in the Bluetooth® menu	43
Placing the device in operation	31	External audio sources	44
Attaching/detaching the control panel	31	Front AUX-IN socket	44
Setting the tuner region.....	31	Rear AUX input.....	44
Switching on/off	31	Sound settings	45
Volume	32	Calling and exiting the audio menu	45
Switching demo mode on/off	32	Performing settings in the audio menu.....	45
Displaying version numbers	32	Calling and exiting the enhanced audio menu	46
Traffic information	32	Performing settings in the enhanced audio menu	46
Radio mode	33	User settings	47
RDS	33	Calling and exiting the user menu.....	47
Changing to radio mode	33	Performing settings in the user menu	47
Selecting the memory bank	33	Factory settings	50
Tuning into a station.....	33	Useful information	51
Storing stations/Calling stored stations.....	34	Warranty.....	51
Scanning stations.....	34	Service	51
Storing stations automatically (Travelstore) ...	34	Technical data	51
PTY	34	Installation instructions	381
Configuring the display.....	35		
CD/MP3/WMA/C'n'C/CD changer mode	35		
Basic information	35		
Changing to CD/MP3/WMA/C'n'C/ CD changer mode.....	36		
Inserting a CD	37		
Ejecting a CD	37		
Connecting/removing a USB data carrier ...	37		
Selecting tracks	37		
Select a folder/CD (only in MP3/WMA/ C'n'C or CD changer mode)	37		
Fast searching.....	38		
Interrupting playback	38		
Playlist mode (only in MP3/WMA mode)	38		
Scanning all tracks.....	38		

Safety notes

The car sound system was manufactured according to the state of the art and established safety guidelines. Even so, dangers may occur if you do not observe the safety notes in these instructions.

These instructions contain important information to easily and safely install and operate the car sound system.

- Read these instructions carefully and completely before using the car sound system.
- Keep the instructions at a location so that they are always accessible to all users.
- Always pass on the car sound system to third parties together with these instructions.

In addition, observe the instructions of the devices used in conjunction with this car sound system.

Symbols used

These instructions employ the following symbols:



DANGER!

Warns about injuries



CAUTION!

Warns about damaging the CD drive



The CE mark confirms the compliance with EU directives.

➔ Identifies a sequencing step

- Identifies a listing

Road safety

Observe the following notes about road safety:

- **Use your device in such a way that you can always safely control your vehicle.** In case of doubt, stop at a suitable location and operate your device while the vehicle is standing.

- **Remove or attach the control panel only while the vehicle is standing an.**
- **Always listen at a moderate volume** to protect your hearing and to be able to hear acoustic warning signals (e.g. police sirens). During mute phases (e.g. when changing the audio source), changing the volume is not audible. Do not increase the volume during this mute phase.

General safety notes

Observe the following notes to protect yourself against injuries:

- **Do not modify or open the device.** The device contains a Class 1 laser that can cause injuries to your eyes.
- **Do not increase the volume during mute phases**, e.g. when changing the audio source. Changing the volume is not audible during a mute phase.

Use as directed

This car sound system is intended for installation and operation in a vehicle with 12 V vehicle system voltage and must be installed in a DIN slot. Observe the performance limits in the technical data. Repairs and installation, if necessary, should be performed by a specialist.

Installation instructions

You may only install the car sound system yourself if you are experienced in installing car sound systems and are very familiar with the electrical system of the vehicle. For this purpose, observe the installation instructions at the end of these instructions.

Declaration of conformity

The Blaupunkt GmbH declares that the car sound system Toronto 400 BT complies with the basic requirements and the other relevant regulations of the directive 1999/5/EG.

Cleaning notes

Solvents, cleaning and scouring agents as well as dashboard spray and plastics care product may contain ingredients that will damage the surface of the car sound system.

- Use only a dry or slightly moistened cloth for cleaning the car sound system.
- If necessary, clean the contacts of the control panel regularly using a soft cloth moistened with cleaning alcohol.

Disposal notes



Do not dispose of your old unit in the household trash!

Use the return and collection systems available to dispose of the old device.

Scope of delivery

The scope of delivery includes:

- 1 Car sound system
- 1 Operating/installation instructions
- 1 Case for the control panel
- 1 Support frame
- 1 Set of small parts
- 2 Disassembly tools
- 1 USB connecting cable

Extended scope of delivery
(for 7 649 036 010 only):

- 1 Connecting cable chamber A (power supply)
- 1 Connecting cable chamber B (loudspeaker)
- 1 Connecting cable chamber C1 (Line-Out)
- 1 Antenna connection adapter
- 1 Handheld remote control
- 2 Batteries (type AAA)

Note:

We recommend the use of original Blaupunkt accessories (www.blaupunkt.com).

Optional equipment (not part of the scope of delivery)

Contact your Blaupunkt specialised dealer or visit us on the Internet under www.blaupunkt.com for information about optional equipment, such as:

- The steering wheel or handheld remote control from Blaupunkt for safe and convenient operation of the basic functions (switching on/off not possible with the remote control)
- The C'n'C-ready interfaces from Blaupunkt (C'n'C = Command and Control) for connecting additional data carriers and devices (e.g. via the iPod®/USB interface)
- Blaupunkt CD changer
- Blaupunkt or Velocity amplifier

Placing the device in operation

Attaching/detaching the control panel

The car sound system is equipped with a detachable control panel (release panel) to protect your equipment against theft. In the delivery state, the control panel is in the supplied case. To start operating the radio after installation, you must first attach the control panel (see the section "Attaching the control panel" in this chapter).

Always take the control panel with you when leaving the vehicle. The car sound system is worthless to a thief without this control panel.

Caution

Damage to the control panel

Never drop the control panel.

Transport the control panel so that it is protected against impacts and the contacts cannot become dirty.

Do not expose the control panel to direct sunlight or another heat source.

Avoid direct skin contact with the control panel's electrical contacts.

Attaching the control panel

- Push the control panel into the bracket at the right edge of the device.
- Push the control panel carefully into the left bracket until it clicks into place.

Removing the control panel

- Press the  button (1) to unlock the control panel.

The left side of the control panel detaches from the device and is secured by a latch against falling out.

- Grasp the control panel at the left side and pull it beyond the resistance of the latch and straight out of the bracket.

Note:

The car sound system automatically switches off as soon as the control panel is removed.

Setting the tuner region

This car sound system is designed for operation in different regions with different frequency ranges and station technologies. It is factory set to the tuner region "EUROPE". Other available tuner regions include "USA", "THAI" (Thailand) and "S AMERICA" (South America). If you operate the car sound system outside of Europe, you may first have to set a suitable tuner region:

- Switch off the car sound system if it is not already turned off.
- Press and hold the buttons **MENU•OK** (15) and **4** (12) at the same time and press the On/Off button (3).

The car sound system switches on. The currently set tuner region appears on the display.

- Press the button  (16) /  (2) repeatedly until the desired tuner region is displayed.
- Press the **MENU•OK** button (15).

Switching on/off

Switching on/off with the On/Off button

- For switch-on, press the On/Off button (3).
The car sound system switches on.
- To switch off the device, press and hold down the On/Off button (3) for longer than 2 seconds.
The car sound system switches off.

Note:

If you switch on the car sound system while the vehicle ignition is switched off, it automatically switches off after 1 hour to preserve the vehicle battery.

Switching on/off via vehicle ignition

The car sound system will switch off/on simultaneously with the ignition if the device is correctly connected to the vehicle's ignition as shown in the installation instructions and you did not switch the device off by pressing the On/Off button (3).

Volume

Adjusting the volume

You can adjust the volume in steps from 0 (off) to 50 (maximum).

- Turn the volume control (4) to change the volume.

Note:

If a telephone or navigation system is connected with the car sound system as described in the installation instructions, the car sound system is muted in case of a telephone call or navigation announcement so that you can hear the playback of the telephone or navigation system undisturbed. While it is muted, the display shows "TELEPHONE".

Muting the car sound system (Mute)

You can quickly reduce the volume to a preset level.

- Briefly press the On/Off button (3) to mute the car sound system or to reactivate the previous volume.

While it is switched low, the display shows "MUTE".

To adjust the mute volume, please read the section "Performing settings in the user menu", "Mute LVL" menu item in the chapter "User settings".

Switching demo mode on/off

The demo mode shows the functions of the car sound system as scrolling text on the display. You can turn the demo mode on or off:

- Switch off the car sound system if it is not already turned off.
- Press and hold the buttons **MENU-OK** (15) and **2** (12) at the same time and press the On/Off button (3).

The car sound system switches on. The display briefly shows "DEMO MODE" if you switched on the demo mode. By pressing any button, the demo mode is interrupted and you can operate the device.

Displaying version numbers

You can display the version numbers of the different device components.

- Switch off the car sound system if it is not already turned off.
- Press and hold the buttons **MENU-OK** (15) and **1** (12) at the same time and press the On/Off button (3).

The car sound system switches on. The display shows the version number of the first component. The first character identifies the component: P = CPU, E = EPROM, A = Accordo, B = Bluetooth®.

- Press the button < (5) / > (14) to display the version number of the other components.
- Press the **MENU-OK** button (15) to return to the previously played audio source.

Traffic information

In the tuner region "EUROPE", an FM station can identify traffic reports by means of an RDS signal. If the priority for traffic announcements is switched on, a traffic announcement is automatically switched through, even if the car sound system is currently not in radio mode or if a station of the wavebands MW or LW is set.

If priority is switched on, the display shows the traffic jam symbol (🚧). "TRAFFIC" is displayed during a switched-through traffic announcement.

To switch the priority on and off, please read the section "Performing settings in the user menu", "TRAF" menu item in the chapter "User settings".

Notes:

- The volume is increased for the duration of the switched-through traffic announcement. You can adjust the minimum volume for traffic announcements (see the ch. "User settings", section "Performing settings in the user menu", "TA VOLUME" menu item).

- To cancel a switched-through traffic announcement, press the **DIS/ESC** button (13).

Radio mode

RDS

Many FM stations broadcast an RDS (Radio Data System) signal in addition to their programme in the tuner region "EUROPE" that allows the following additional functions:

- The station name is shown on the display.
- The car sound system recognises traffic announcements and news broadcasts and can automatically switch them through in any operating mode (e.g. in CD mode).
- Alternate frequency: If RDS is activated, the car sound system automatically selects the best receivable frequency for the station that is currently set.
- Regional (REG): At certain times, some radio stations divide their programme into regional programmes providing different content. If the REG function is activated, the car sound system changes only to those alternate frequencies on which the same regional programme is being broadcast.

To switch the RDS or REG function on or off, please read the section "Performing settings in the user menu" in the chapter "User settings" (menu items "RDS", "REG").

Changing to radio mode

- Press the **SRC** button (6) repeatedly until "TUNER" is displayed:

The current memory bank appears once as scrolling text on the display.

Selecting the memory bank

The following memory banks are available in the different tuner regions:

Region	Memory banks
EUROPE	FM1, FM2, FMT, MW, LW
USA	FM1, FM2, FMT, AM, AMT
THAI	FM1, FM2, FMT, AM
S AMERICA	FM1, FM2, FMT, AM, AMT

- Press the button **∨** (16) / **∧** (2) repeatedly until the desired memory bank is displayed.

Note:

Up to 5 stations can be stored in each memory bank.

Tuning into a station

There are various ways of tuning into a station:

Tuning into stations manually

- Briefly press the button **<** (5) / **>** (14) once or several times to change the frequency in increments, or long to quickly change the frequency.

Notes:

- For the tuner region "EUROPE": In the FM waveband, the next station of the broadcasting network is automatically tuned into if the RDS function is switched on.
- For the tuner regions "EUROPE", "USA" and "S AMERICA": In the FM waveband, the current selected programme type is displayed and can be changed if the PTY function is activated (see the ch. "PTY").

Starting station seek tuning

- Press the button **<** (5) / **>** (14) for approx. 2 seconds to start station seek tuning.

The radio tunes into the next receivable station.

Notes:

- For the tuner region "EUROPE": In the FM waveband, only traffic information stations are tuned into if the priority for traffic information () is switched on.
- For the tuner regions "EUROPE", "USA" and "S AMERICA": In the FM waveband, the next station with the currently selected programme type is tuned into if the PTY function is activated (see the ch. "PTY").
- The sensitivity of seek tuning can be adjusted (see the chapter "User settings", section "Performing settings in the user menu", menu item "SENS").

Storing stations/Calling stored stations

- Select the desired memory bank.
- If necessary, set the desired station.
- Press the station button **1 - 5** (12) for approx. 2 seconds to store the current station under the button.
- or -
- Briefly press the station button **1 - 5** (12) to call up the stored station.

Scanning stations

The scan function is used to scan every receivable station of the current waveband.

- Press the **MENU-OK** button (15) for approx. 2 seconds to start the scan, or long to continue playing the currently set station.

During the scan, the display alternately displays "SCAN" and the current frequency as well as memory bank or station name.



Note:

For radio mode, you can adjust the scan time for each station (see the ch. "User settings", section "Performing settings in the user menu", "SCAN TIME" menu item).

Storing stations automatically (Travelstore)

With Travelstore, you can automatically search for and store the 5 FM stations offering the strongest reception in the region in one memory bank. Any previously stored stations in this memory bank are deleted in the process.

In the tuner regions "EUROPE" and "THAI", you can store 5 FM stations in the FMT memory bank with Travelstore. In the tuner regions "USA" and "S AMERICA", you can also store 5 AM stations in the AMT memory bank.

- Select a memory bank of the desired waveband, e.g. FM1 or AM.
- Press the button  (16) /  (2) for approx. 2 seconds.

The tuner starts the automatic station seek tuning; the display shows "FM TSTORE" or "AM TSTORE". After the storing is completed, the radio plays the station at memory location 1 of the FMT or AMT level.

Note:

For the tuner region "EUROPE": If the priority for traffic information is switched on () , only traffic information stations are stored.

PTY

In the tuner regions "EUROPE", "USA" and "S AMERICA", an FM station can transmit its current programme type, e.g. CULTURE, POP, JAZZ, ROCK, SPORT or SCIENCE. Hence, the PTY function allows a targeted search for broadcasts of a certain programme type, e.g. for rock or sports broadcasts. Note that PTY is not supported by all stations.

Note:

To use the PTY function, you must activate it separately in the menu (see the ch. "User settings", section "Performing settings in the user menu", "PTY" menu item).

Selecting a programme type**Note:**

In the tuner region "EUROPE", you can adjust the language in which the programme types are displayed (see the ch. "User settings", section "Performing settings in the user menu", "PTY LANG" menu item).

- Briefly press the button \leftarrow (5) / \rightarrow (14).

The currently selected programme type is briefly displayed, and you can select a different programme type.

- If necessary, press the button \leftarrow (5) / \rightarrow (14) repeatedly until the desired programme type is selected.

Searching for stations

- Press the button \leftarrow (5) / \rightarrow (14) for approx. 2 seconds.

As soon as the seek tuning starts, the display briefly shows "SEARCH". Afterwards, the current programme type is displayed.

As soon as a station is found, "PTY FOUND" is briefly shown. As long as the programme type of the adjusted station corresponds to the currently selected programme type, the display alternately shows the programme type and the station name or frequency.

Notes:

- If no station with the selected programme type is found, "NO PTY" is briefly displayed and a beep sounds. The radio will then retune to the station that it played last.

- If the tuned radio station or another station on the broadcasting network broadcasts your selected programme type at a later point in time, the car sound system will automatically switch from the currently tuned station or from the current audio source (e.g. CD) to the station whose programme type matches the one you selected. Note that this function is not supported by all stations.

Configuring the display

- Press the **DIS/ESC** button (13) to change between these two displays:

Display	Meaning
ABCDEF or FM1 102.90	Station name or memory bank/frequency
FM1 11:32	Memory bank/time

**CD/MP3/WMA/C'n'C/
CD changer mode****Basic information****CD/MP3/WMA mode**

This car sound system can be used to play audio CDs (CDDA) and CD-R/RWs with audio, MP3 or WMA files as well as MP3 or WMA files on USB data carriers.

**Risk of severe damage to the CD drive!**

Noncircular contoured CDs (shape CDs) and CDs with a diameter of 8 cm (mini CDs) must not be used.

We accept no responsibility for any damage to the CD drive that may occur as a result of the use of unsuitable CDs.

Notes:

- To ensure proper functioning, use only CDs with the Compact-Disc logo.

- Blaupunkt cannot guarantee the flawless function of copy-protected CDs and all CD blanks and USB data carriers available on the market.

Note the following information when preparing an MP3/WMA data carrier:

- Naming of tracks and directories:
 - Max. 16 characters (CD) or 24 characters (USB) incl. the file extension ".mp3" or ".wma" (if more characters are used, the number of tracks and folders that are recognisable by the car sound system is reduced)
 - No umlauts or special characters
- CD formats: Audio CD (CDDA), CD-R/RW, Ø: 12 cm
- CD data formats: ISO 9669 Level 1 and 2, Joliet
- CD burn speed: Max. 16x (recommended)
- USB format/file system: Mass storage device/FAT32
- File extension of audio files:
 - .MP3 for MP3 files
 - .WMA for WMA files
- WMA files only without Digital Rights Management (DRM) and created with Windows Media Player version 8 or later
- MP3 ID3 tags: Version 1 and 2
- Bitrate for creating audio files:
 - MP3: 32 to 320 kbps
 - WMA: 32 to 192 kbps
- Max. number of tracks: 20,000

C'n'C mode

The C'n'C interface from Blaupunkt (C'n'C = Command and Control) allows an even more convenient control of devices and data carriers that are connected to the car sound system via a C'n'C-ready Blaupunkt interface.

Before connecting a C'n'C-ready Blaupunkt interface, check the mode of the rear AUX input. For further details, please read the section "Rear AUX input" in the chapter "External audio sources".

CD changer mode

You can connect the following CD changers to the car sound system:

- Blaupunkt CDC A03
- Blaupunkt CDC A08
- Blaupunkt IDC A09

Information on handling CDs, inserting CDs and operating the CD changer can be found in the operating instructions supplied with your CD changer.

Before connecting a CD changer, check the mode of the rear AUX input. For further details, please read the section "Rear AUX input" in the chapter "External audio sources".

Changing to CD/MP3/WMA/C'n'C/ CD changer mode

➤ Press the **SRC** button  repeatedly until the desired audio source is displayed:

- "CD": Inserted CD.
- "MP3": Inserted CD that has already been recognised as MP3 CD.
- "USB": Connected USB data carrier.
- Name of the device connected via C'n'C
- "CDC / AUX": Connected CD changer (if no other external audio source is connected).

Notes:

- The respective audio source can be selected only if a corresponding CD is inserted or a corresponding device (e.g. a USB data carrier or CD changer) is connected.
- If the car sound system first has to read the data of a connected device or data carrier before the playback, the display shows "READING". For large data volumes, this may take up to 1 minute. If the device or data carrier is defective or the transferred data cannot be played back, a corresponding message appears on the display (e.g. "ERROR" or "USB ERROR").

- If the connected CD changer first acquires the inserted CDs (e.g. after an interruption of the power supply or a change of the magazine), "MAG SCAN" is displayed. If the CD changer does not contain any CDs or magazine, "NO DISC" is displayed.

Inserting a CD

Note:

You must not hinder or assist the drive as it automatically draws in the CD.

- Insert the CD with its printed side up into the CD tray (7) until you feel a slight resistance. The CD is automatically pulled in and its data are checked (the display shows "READING" during this time). Afterwards, the playback starts in CD or MP3 mode. If a CD is inserted, the display shows the CD symbol.

Note:

If the inserted CD cannot be played back, "CD ERROR" is briefly displayed and the CD is automatically ejected after approx. 2 seconds.

Ejecting a CD

Notes:

- If a CD is ejected and not removed, the drive will automatically draw it back in again after approx. 10 seconds.
 - You can also eject CDs while the car sound system is switched off or whilst another audio source is activated.
- Press the  button (10) to eject an inserted CD.

Connecting/removing a USB data carrier

To be able to connect a USB data carrier, the supplied USB cable must be connected to the car sound system (see Installation Instructions).



- Switch of the car sound system so that the data carrier will be correctly registered and unregistered.
- Connect the USB data carrier to the USB cable or pull it off.

If a USB data carrier is connected, the display shows the USB symbol. If the USB data carrier is initially selected as audio source after connecting it or after switching on the car sound system, the data are read in first (the display shows "READING" during this time).

Notes:

- If the connected USB data carrier cannot be seen, "USB ERROR" is briefly displayed.
- The time required for reading in the data depends on the design and size of the USB data carrier.

Selecting tracks

- Briefly press the button  (5) /  (14) to change to the previous/next track.

Note:

If the current track plays longer than 3 seconds, pressing  (5) once restarts the track.

Select a folder/CD (only in MP3/WMA/C'n'C or CD changer mode)

- Press the button  (16) /  (2) to change to the previous/next folder or CD.

Note:

This also allows you to change between playlists of a device connected via C'n'C.

Fast searching

- Press and hold down the button \leftarrow (5) / \rightarrow (14) until the desired position has been reached.

Interrupting playback

- Press the button 3 \parallel (12) to interrupt the playback ("PAUSE") or to continue.

Playlist mode (only in MP3/WMA mode)

The car sound system can play playlists that were created with an MP3 manager, such as WinAmp or Microsoft Media Player. The playlists must be stored in the root folder of the CD or USB data carrier. The following playlist formats can be recognised: M3U, PLS.

Selecting tracks in Playlist mode

- Press the 2 button (12) for approx. 2 seconds to change to the Playlist mode:

"LIST MODE" briefly appears on the display. The first track of the first playlist is played.

Note:

If the data carrier does not contain any playlists, "NO LIST" is briefly displayed.

- Briefly press the button \leftarrow (5) / \rightarrow (14) to change to the previous/next track of the current playlist.
- Press the button ∇ (16) / \blacktriangleright (2) to change to the previous/next playlist.

The display briefly shows the name of the selected playlist, and the first track of the playlist is being played.

Exiting the Playlist mode

- Press the 2 button (12) for approx. 2 seconds:
- "LIST OFF" briefly appears on the display. The current track continues playing.

Scanning all tracks

The scan function scans all available tracks.

- Press the **MENU-OK** button (15) for approx. 2 seconds to start the scan, or long to continue playing the currently scanned track.

During the scan, the display alternately displays "SCAN" and the current track number or file name.

Notes:

- In the CD changer mode, the scan time per track is approx. 10 seconds. For all other operating modes, you can adjust the scan time for each track (see the ch. "User settings", section "Performing settings in the user menu", "SCAN TIME" menu item).
- In the Playlist mode (MP3 mode), only the tracks of the current playlist are scanned.

Playing tracks in random order

- Press the 5 **MIX** button (12) to change between the playback modes:

Operation	Display	Meaning
CD	MIX ALL	Mixing tracks
MP3/ WMA/ C'n'C ¹	MIX DIR ²	Mixing tracks of the current folder
	MIX ALL ²	Mixing tracks of the data carrier
CDC	MIX CD	Mixing tracks of the current CD
	MIX ALL	Mixing tracks of all CDs
Gen.	MIX OFF	Regular playback

¹ In C'n'C mode, additional playback modes may be available depending on the connected device

² Not in MP3 Playlist mode

If the MIX function is active, the **MIX** symbol appears on the display.

Repeatedly playing individual tracks, CDs or directories

- Press the **4 RPT** button (12) to change between the playback modes:

Operation	Display	Meaning
CD	RPT TRACK	Repeating tracks
MP3/ WMA/ C'n'C ¹	RPT TRACK	Repeating tracks
	RPT DIR ²	Repeating folders
CDC	RPT TRACK	Repeating tracks
	RPT DISC	Repeating a CD
Gen.	RPT OFF	Regular playback

¹ In C'n'C mode, additional playback modes may be available depending on the connected device

² Not in MP3 Playlist mode

If the RPT function is active, the **RPT** symbol appears on the display.

Configuring the display

- Press the **DIS/ESC** button (13) once or several times to change between these displays:

Operation	Display	Meaning
CD	T 01 02:15	Track number and playing time
	T 01 18:33	Track number and time
MP3/ WMA/ C'n'C	01 ABC	File name
	ABCDEF	Artist ¹
	ABCDEF	Album name ¹
	PLAY 02:15	Playing time
	CLK 18:33	Time
CDC	T 01 02:15	Track number and playing time
	T 01 18:33	Track number and time
	CD 02T 03	CD number and track number

¹ Artist and album name must be stored as ID3 tag and are displayed only for approx. 10 seconds and perhaps as scrolling text; otherwise, the file name is displayed.

Note

You can switch the display of CD text of an audio CD on and off (see the ch. "User settings", section "Performing settings in the user menu", "CD TEXT" menu item). If CD text is switched on, the corresponding CD text is displayed once as scrolling text at the start of a track.

Bluetooth®

You can connect the car sound system via Bluetooth® with other Bluetooth®-ready devices, such as cell phones or MP3 players. This allows you to use the car sound system with its integrated microphone as hands-free system for connected cell phones and control the audio output of other Bluetooth® devices and play them back via the loudspeakers of the car sound system (Bluetooth® streaming).

Bluetooth® technology is a wireless connection of short range. For this reason, Bluetooth® devices must be located near the car sound system (in the vehicle) to establish and maintain a connection.

To establish a Bluetooth® connection, you must first register the car sound system and the Bluetooth® device. When you register the devices, a Bluetooth® connection is subsequently established automatically. This connection remains in effect as long as the Bluetooth® device is within range. If the connection is interrupted, e.g. because you moved the cell phone outside the range, the connection is automatically re-established as soon as you are back within range.

You can connect only one cell phone and streaming device with the car sound system at a time. If you connect a new device with the car sound system, the connection to a currently connected device may automatically be interrupted. However, the car sound system leaves up to 5 different Bluetooth® devices registered, and you can quickly and easily connect any of these devices

with the car sound system again. If you register a sixth one, the Bluetooth® device registered first is unregistered.

Bluetooth® menu

In the Bluetooth® menu, you find all the functions for registering, connecting and managing Bluetooth® devices.

Calling the Bluetooth® menu

- Press the **MENU•OK** button (15).
- Press the **√** button (16) to select the "BLUETOOTH" menu item.
- Press the **>** button (14) to open the Bluetooth® menu.
- Press the button **√** (16) / **↶** (2) repeatedly until the desired menu item is selected.

Notes:

- The Bluetooth® menu is automatically exited approx. 30 seconds after the last button activation and you are returned to the display of the current audio source.
- If a Bluetooth® process is running (e.g. re-establishing the connection to the last connected device), the functions of the Bluetooth® menu are blocked. If you attempt to open the Bluetooth® menu during this time, "LINK BUSY" appears on the display. To return to the current audio source, press the **DIS/ESC** button (13). To cancel the Bluetooth® process and open the Bluetooth® menu, press the **↶** button (17).

Exiting the Bluetooth® menu

- Briefly press the **DIS/ESC** button (13) to exit the Bluetooth® menu.

Registering and connecting a device

Registering and connecting a cell phone

- In the Bluetooth® menu, select the "PAIR" menu item.
- Press the **>** button (14) to open the sub-menu.
The "PHONE" menu item is selected.

- Press the **>** button (14) to register a cell phone.

The display shows "PAIRING" and the Bluetooth® symbol is flashing. The car sound system can now be recognised by a Bluetooth® cell phone for approx. 2 minutes and connected.

- Search the car sound system from your cell phone (Bluetooth® name: "TORONTO 400 BT").

As soon as the car sound system is found by the cell phone and should be connected, "ENTER PIN" appears on the display and the PIN "1234".

- Establish the connection from your cell phone. Enter the PIN displayed by the car sound system.

The display may show "PAIRED", followed by "CONNECTED", as soon as the car sound system and the cell phone are registered and connected.

Note:

If no connection can be established, "CON FAIL" (connection failed) is briefly displayed.

Registering and connecting a Bluetooth® streaming device

- In the Bluetooth® menu, select the "PAIR" menu item.
- Press the **>** button (14) to open the sub-menu.

The "PHONE" menu item is selected.

➤ Press the **√** button (16) to select the "STREAMING" menu item.

➤ Press the **>** button (14) to register a streaming device.

The display shows the currently stored PIN (default "1234"). If required, enter the PIN of the streaming device:

➤ Press the button **√** (16) / **↶** (2) repeatedly until the desired number appears at the respective current location.

➤ Press the button **<** (5) / **>** (14) to change between the 4 locations of the PIN.

➤ Press the **MENU-OK** button (15) to confirm the PIN entered.

Note:

Not all streaming devices require the entry of a PIN on the car sound system. For some streaming devices, you have to enter the PIN of the car sound system instead. For those devices, you can simply confirm the current PIN of the car sound system by pressing the **MENU-OK** button (15) and then enter it on the streaming device.

The display shows "PAIRING" and the Bluetooth® symbol is flashing. The car sound system can now be recognised by the streaming device for approx. 2 minutes and connected.

➤ Search the car sound system from your streaming device (Bluetooth® name: "TORONTO 400 BT") and establish the connection. Enter the PIN of the car sound system, if necessary.

The display may show "PAIRED", followed by "CONNECTED", as soon as the car sound system and the streaming device are registered and connected.

Note:

If no connection can be established, "CON FAIL" (connection failed) is briefly displayed.

Telephone functions

Answering/rejecting an incoming phone call

With an incoming call, the display alternately shows "INCOMING" and the number of the caller. The current audio source is muted and a ring tone is played via the loudspeakers of the car sound system.

Note:

If the number of the caller is not being transmitted, the display shows "PRIVATE NUMBER" instead of the number. If the number of the caller is stored together with a name, the name of the entry and the number are displayed (see the ch. "Storing a phone number").

➤ Press the **↶** button (18) to answer the call. "CALL" and the duration of the ongoing call are displayed.

➤ Press the **↷** button (17) to reject the call or to end the current call.

The display shows "CALL END".

Making a call

➤ In the Bluetooth® menu, select the "DIAL NEW" menu item.

➤ Press the **>** button (14).

You can now enter a phone number with up to 20 digits:

➤ Press the button **√** (16) / **↶** (2) repeatedly until the desired number appears at the respective current location.

➤ Press the button **<** (5) / **>** (14) to change between the locations of the number.

➤ Press the **↶** button (18) to call the number entered.

"OUTGOING" and the dialed number are alternately shown on the display.

Note:

If the dialed number is stored together with a name, the name of the entry and the number are displayed (see the ch. "Storing a phone number").

As soon as your calling party answers the call, the display alternately shows "CALL" and the time of the current phone call.

Storing phone numbers

➤ In the Bluetooth® menu, select the "DIAL NEW" menu item.

➤ Press the > button (14).

You can now enter a phone number with up to 20 digits:

➤ Press the button \surd (16) / \blacktriangleright (2) repeatedly until the desired number appears at the respective current location.

➤ Press the button < (5) / > (14) to change between the locations of the number.

➤ Press the desired memory button 1 - 5 (12) for approx. 2 seconds to store only the number.

- or -

➤ Press the **MENU-OK** button (15) to enter a name for the entry.

You can now enter a name with up to 9 characters:

➤ Press the button \surd (16) / \blacktriangleright (2) repeatedly until the desired character appears at the respective current location.

➤ Press the button < (5) / > (14) to change between the locations of the name.

➤ Press the desired memory button 1 - 5 (12) for approx. 2 seconds to store the number and name.

Note:

A number previously stored on the memory button is replaced.

Speed dial

With speed dial, you can call the number dialed last or a stored number (see ch. "Storing a phone numbers").

➤ Press the  button (18).

The display shows the number dialed last.

Note:

If no cell phone is currently connected, the Bluetooth® menu is opened. The "PAIR" menu item is selected.

➤ If necessary, press a memory button 1 - 5 (12) to call the number stored.

➤ Press the  button (18) to call the number. "OUTGOING" and the dialed number are alternately shown on the display.

Bluetooth® streaming mode

Starting the Bluetooth® streaming mode

➤ Press the **SRC** button (6) repeatedly until "BT STREAM" appears on the display.

The playback starts.

Notes:

- The Bluetooth® streaming mode can be selected only if a suitable streaming device is connected.
- If the connection to the streaming device is lost during playback, the display briefly shows "CON LOST" (connection lost) and the car sound system changes to the previous audio source.

Selecting tracks

➤ Briefly press the button < (5) / > (14) to change to the previous/next track.

Additional functions in the Bluetooth® menu

Changing the Bluetooth® PIN

The factory-set Bluetooth® PIN of the car sound system is "1234"; e.g. it must be entered on the cell phone when registering a cell phone. This PIN can be changed.

- In the Bluetooth® menu, select the "PIN EDIT" menu item.
- Press the > button (14) to open the sub-menu.
- Press the button ∇ (16) / \blacktriangleright (2) repeatedly until the desired number appears at the respective current location.
- Press the button < (5) / > (14) to change between the 4 locations of the PIN.
- Press the **MENU•OK** button (15).

Managing registered devices

In the Bluetooth® menu, you can manage the registered Bluetooth® devices (cell phones and streaming devices such as MP3 player).

The registered devices are displayed in the device lists for cell phones ("PHN LIST") and streaming devices ("STR LIST"). You can do the following:

- Disconnecting the connection to the currently connected Bluetooth® device
 - Establishing a connection to one of the registered Bluetooth® devices
 - Unregistering a Bluetooth® device
 - In the Bluetooth® menu, select the menu item "PHN LIST" or "STR LIST".
 - Press the > button (14) to open the sub-menu.
- The first device on the list is displayed.

Note:

If no device is registered, "EMPTY" is briefly displayed.

- If necessary, press the button ∇ (16) / \blacktriangleright (2) repeatedly until the desired device is displayed.

You have the following options:

- Press the \blacktriangleright button (18) to connect the device displayed.

The display shows "CONNECTNG". As soon as the device is connected, "CONNECTED" is briefly displayed and you are returned to the Bluetooth® menu. If the device is already connected, "CON EXIST" (connection exists) is briefly displayed and you are returned to the list of registered cell phones or streaming devices.

- Press the \blacktriangleleft button (17) to disconnect the connection to the device displayed.

The display briefly shows "DISCONNTD" and you are returned to the Bluetooth® menu. If the device was not connected, "NO CONNCT" (no connection) is briefly displayed and you are returned to the list of registered cell phones or streaming devices.

- Press the \blacktriangleleft button (17) for approx. 2 seconds to unregister the displayed device.

The display briefly shows "DELETED" and you are returned to the Bluetooth® menu.

Unregistering all registered devices

- In the Bluetooth® menu, select the "DELETE ALL" menu item.
 - Press the > button (14) to unregister all registered devices.
- The display shows "CONFIRM".
- Press the > button (14) again.
- The display briefly shows "DELETED".

External audio sources

Front AUX-IN socket



Danger! Increased risk of injury from connector.

In case of an accident, the protruding connector in the front AUX-IN socket may cause injuries. The use of straight plugs or adapters leads to an increased risk of injury.

For this reason, we recommend using angled jack plugs, e.g. the Blaupunkt accessories cable (7 607 001 535).

As soon as an external audio source, such as a portable CD/MiniDisc or MP3 player is connected to the Front-AUX-IN socket, it can be selected with the **SRC** button . "FRONT AUX" then appears on the display.

Rear AUX input

Different external audio sources can be connected to the car sound system via the rear AUX input (Rear-AUX-IN):

- C'n'C-ready devices from the Blaupunkt accessories programme (e.g. a C'n'C-ready Bluetooth®/USB or iPod®/USB interface; C'n'C = Command and Control).
- CD changer
- Other external audio sources, such as portable CD players, MiniDisc players, MP3 players or a non-C'n'C-capable Blaupunkt interface.

Note:

An adapter cable is needed to connect an external audio source via the rear AUX input. You can obtain this cable (Blaupunkt no.: 7 607 897 093) from your Blaupunkt dealer.

Before you connect a certain device, first check the mode of the rear AUX input and, if necessary, change the setting (see ch. "User settings", section "Performing settings in the user menu",

"CDC" menu item). Ensure that you change the setting only as long as no device is connected to the rear AUX input. If necessary, remove connected devices first while the car sound system is switched off.

Starting C'n'C mode

- Press the **SRC** button  repeatedly until the name of the device connected via C'n'C appears on the display.

The playback starts.

Notes:

- The C'n'C mode can be selected only if a suitable device is connected via a C'n'C-ready interface.
- To operate the radio in C'n'C mode, please read the chapter "CD/MP3/WMA/C'n'C/CD changer mode".
- When using suitable adapter cables, you can connect up to 3 C'n'C-ready Blaupunkt interfaces to the car sound system. For the car sound system to distinguish the different interfaces, you can assign an individual device number to every interface (see ch. "User settings", section "Performing settings in the user menu", "C'n'C" menu item).

Starting AUX mode

- Press the **SRC** button  repeatedly until "CDC / AUX" appears on the display.

The playback starts.

Note:

You can enter a separate name for the rear AUX input that is shown on the display in AUX mode if you selected the connected audio source (see ch. "User settings", section "Performing settings in the user menu", "AUX EDIT" menu item).

Sound settings

The following sound settings can be changed in the Audio menu:

- Adjusting bass and treble
- Setting the left/right volume distribution (Balance) or front/rear (Fader)
- Setting the boost of bass at low volume (X-Bass).

In the Enhanced Audio menu, you can also perform the following settings:

- Setting the 3-band equalizer:
 - Setting the middle level
 - Selecting bass, middle and treble
 - Adjusting quality factor for bass and middle
- Performing advanced X-Bass settings (level and frequency)
- Selecting equalizer presets

Note:

The settings for bass, middle and treble are each stored for the current audio source.

Calling and exiting the audio menu

- Briefly press the **MENU•OK** button (15) to open the User menu.
- Press the button **↵** (16) / **↶** (2) repeatedly until the "AUDIO" menu item is selected.
- Press the **➤** button (14) to open the audio menu.
- Press the button **↵** (16) / **↶** (2) repeatedly until the desired menu item is selected.
- Perform the setting (see the next section).
- Briefly press the **MENU•OK** button (15) to select a different menu item.
 - or -
- Briefly press the **DIS/ESC** button (13) to exit the menu.

Note:

The menu is automatically exited approx. 15 seconds after the last button activation and you are returned to the display of the current audio source.

Performing settings in the audio menu

BASS

Bass level. Settings: -7 to +7.

- Press the **➤** button (14) to open the sub-menu.
- Press the button **↵** (16) / **↶** (2) to perform the setting.

TREBLE

Treble. Settings: -7 to +7.

- Press the **➤** button (14) to open the sub-menu.
- Press the button **↵** (16) / **↶** (2) to perform the setting.

BALANCE

Left/right volume distribution. Settings: L9 (left) to R9 (right).

- Press the **➤** button (14) to open the sub-menu.
- Press the button **↵** (16) / **↶** (2) to perform the setting.

FADER

Front/rear volume distribution. Settings: R9 (rear) to F9 (front).

- Press the **➤** button (14) to open the sub-menu.
- Press the button **↵** (16) / **↶** (2) to perform the setting.

X-BASS

Increase of bass at low volume. Settings: 0 (off) to 3 (highest increase).

- Press the **➤** button (14) to open the sub-menu.

➤ Press the button **↵**(16) / **↩**(2) to perform the setting.

Calling and exiting the enhanced audio menu

➤ In the audio menu, select the "ENHANCED" menu item.

➤ Press the **➤** button (14) to open the ENHANCED menu.

➤ Press the button **↵**(16) / **↩**(2) repeatedly until the desired menu item is selected.

➤ Perform the setting (see the next section).

➤ Briefly press the **MENU-OK** button (15) to select a different menu item.

- or -

➤ Briefly press the **DIS/ESC** button (13) to exit the menu.

Performing settings in the enhanced audio menu

E-BASS

Adjusting bass frequency and quality factor. Settings:

- Bass frequency: 60/80/100/200 Hz
- Quality factor: 1.0/1.25/1.5/2.0

➤ Press the **➤** button (14) to open the E-BASS submenu.

➤ Press the button **↵**(16) / **↩**(2) to change between the submenus "FREQ" (frequency) and "QFAC" (quality factor).

➤ Press the button **<**(5) / **>**(14) to change between the available settings of the submenu.

E-TREBLE

Setting the treble frequency. Settings: 10/12.5/15/17.5 kHz.

➤ Press the **➤** button (14) to open the E-TREBLE submenu.

➤ Press the button **<**(5) / **>**(14) to change between the available settings of the submenu.

E-MIDDLE

Setting the middle level and frequency as well as quality factor. Settings:

- Middle level: -7 to +7
- Centre frequency: 0.5/1.0/1.5/2.5 kHz
- Quality factor: 0.5/0.75/1.0/1.25

➤ Press the **➤** button (14) to open the E-MIDDLE submenu.

➤ Press the button **↵**(16) / **↩**(2) to change between the submenus "GAIN" (level), "FREQ" (frequency) and QFAC (quality factor).

➤ Press the button **<**(5) / **>**(14) to change between the available settings of the submenu.

E-XBASS

Setting the X-bass level and frequency. Settings:

- X-bass level: 0 (off) to 3
- X-bass frequency: 30/60/100 Hz

➤ Press the **➤** button (14) to open the E-XBASS submenu.

➤ Press the button **↵**(16) / **↩**(2) to change between the submenus "GAIN" (level) and "FREQ" (frequency).

➤ Press the button **<**(5) / **>**(14) to change between the available settings of the submenu.

PRESETS

Selecting equalizer presets. Settings: POP, ROCK, CLASSIC, P-EQ OFF (no presetting).

➤ Press the **➤** button (14) to open the PRESETS submenu.

➤ Press the button **↵**(16) / **↩**(2) to change between the settings.

User settings

Calling and exiting the user menu

- Briefly press the **MENU•OK** button (15) to open the menu.
 - Press the button **∇** (16) / **↶** (2) repeatedly until the desired menu item is selected.
 - Perform the setting (see the next section).
 - Briefly press the **MENU•OK** button (15) to select a different menu item.
- or -
- Briefly press the **DIS/ESC** button (13) to exit the menu.

Note:

The menu is automatically exited approx. 15 seconds after the last button activation and you are returned to the display of the current audio source.

Performing settings in the user menu

CDC

Setting the rear AUX input mode Settings: ON (to connect a CD changer or another external audio source), OFF (to connect a C'n'C-ready Blaupunkt interface).

- Press the **>** button (14) to open the sub-menu.
- Press the **>** button (14) to change between the settings.
- Briefly press the **MENU•OK** button (15) to confirm the selected setting.

The car sound system automatically switches off and on again with the selected setting.

C'n'C

Assigning an individual device number to connected C'n'C-ready interfaces (C'n'C = Command and Control). Length: 4 digits, characters: 0-9, A-F (hexadecimal).

- Press the **>** button (14) to open the sub-menu.
- Press the button **∇** (16) / **↶** (2) to select the interface ("DEV 1 - 3").
- Press the **>** button (14) to change the device number.
- Press the button **<** (5) / **>** (14) to change between the positions.
The character at the selected position flashes if selected.
- Press the button **∇** (16) / **↶** (2) to select a character at the selected location.
- Briefly press the **MENU•OK** button (15) to confirm the device number entered.

CDTEXT

Switching the display of CD text on or off. Settings: ON, OFF.

- Press the **>** button (14) to open the sub-menu.
- Press the **>** button (14) to change between the settings.
- Briefly press the **MENU•OK** button (15) to confirm the selected setting.

TA VOLUME

(only for tuner region "EUROPE")

Setting the minimum volume for traffic announcements. Settings: 1 - 50.

- Press the **>** button (14) to open the sub-menu.
- Press the button **∇** (16) / **↶** (2) or turn the volume control (4) to perform the setting.

SENS

Only possible in FM radio mode: Setting the sensitivity of station seek tuning. Settings: LO1 (lowest) - HI6 (highest).

- Press the **>** button (14) to open the sub-menu.
- Press the button **∇** (16) / **↶** (2) to perform the setting.

SCAN TIME

Setting the scan time in 5-second increments. Settings: 5 – 30.

- Press the > button (14) to open the sub-menu.
- Press the button √ (16) / ⏏ (2) to perform the setting.

CLOCK SET

Setting the time.

- Press the > button (14) to open the sub-menu.
- Press the button < (5) / > (14) to change between minutes and hours.
The minute or hour display flashes if it is selected.
- Press the button √ (16) / ⏏ (2) to adjust the minutes or hours.
- Briefly press the **MENU-OK** button (15) to confirm the time entered.

Note:

In 12-hour mode (12H MODE), an "A" is displayed after the time for the time before noon or a "P" for the time after noon.

12H/24H MODE

Selecting the 12 or 24-hour time. Settings: 12H, 24H.

- Press the > button (14) to open the sub-menu.
- Press the > button (14) to change between the settings.

CLOCK

Switching the display of time on or off with radio and vehicle ignition switched off. Settings: ON, OFF.

- Press the > button (14) to open the sub-menu.
- Press the > button (14) to change between the settings.

- Briefly press the **MENU-OK** button (15) to confirm the selected setting.

BEEP

Switching the confirmation beep on or off. Settings: ON, OFF.

- Press the > button (14) to open the sub-menu.
- Press the > button (14) to change between the settings.
- Briefly press the **MENU-OK** button (15) to confirm the selected setting.

MUTE LVL

Setting the volume for low volume. Settings: 0 - 50.

- Press the > button (14) to open the sub-menu.
- Press the button √ (16) / ⏏ (2) or turn the volume control (4) to perform the setting.

ON VOLUME

Setting the power-on volume Settings: 0 – 50 or LAST VOL (volume set last before switching off the car sound system). With the "LAST VOL" setting, the power-on volume is limited to max. 25.

- Press the > button (14) to select the setting "LAST VOL".
- or -
- Press the < button (5) to set the power-on volume between 0 and 50.
- Press the button √ (16) / ⏏ (2) or turn the volume control (4) to perform the setting.

REG

(only for tuner region "EUROPE")

Only possible in FM radio mode: Switching REG function on or off. Settings: ON, OFF.

- Press the > button (14) to open the sub-menu.
- Press the > button (14) to change between the settings.

PTY LANG**(only for tuner region "EUROPE")**

Only possible in FM radio mode: Selecting the language for the display of programme types. Settings: ENGLISH, FRANCAIS, DEUTSCH.

- Press the > button (14) to open the sub-menu.
- Press the button √ (16) / ↵ (2) to change between the settings.

PTY**(only for tuner regions "EUROPE", "USA", "S AMERICA")**

Only possible in FM radio mode: Switching PTY function on or off. Settings: ON, OFF.

- Press the > button (14) to open the sub-menu.
- Press the > button (14) to change between the settings.

DISP COL

Mixing the colour for the display illumination from the basic colours Red, Green and Blue (RGB). Settings: For R, G and B each 0 to 16.

- Press the < button (5) to select the "4096 COL" submenu (setting R, G and B) or the > button (14) to select the "256 COL" submenu (setting R and G, B remains unchanged).
- Press the > button (14) to open the sub-menu.
- Press the button < (5) / > (14) to change between the colours.

The value of the selected colour flashes.

- Press the button √ (16) / ↵ (2) to adjust the value of the selected colour.
- Briefly press the **MENU•OK** button (15) to confirm the selected setting.

SCAN

Switching the constant colour change of the display illumination on or off. Settings: ON, OFF.

- Press the > button (14) to open the sub-menu.

- Press the > button (14) to change between the settings.

- Briefly press the **MENU•OK** button (15) to confirm the selected setting.

If the constant colour change is switched on, the colour of the display illumination changes constantly across the colour spectrum.

COL SCAN

Selecting the colour of the display illumination during a colour seek.

- Press the > button (14) to start the colour seek.

The display alternately shows "SCANNING" and "OK (MENU)" and the colour of the display illumination changes constantly.

- Briefly press the **MENU•OK** button (15) to select the currently set colour.

DIM DAY/DIM NIGHT

Setting the display brightness for the day (DIM DAY) or the night (DIM NIGHT). Settings: 1 – 16.

- Press the > button (14) to open the sub-menu.
- Press the button √ (16) / ↵ (2) to perform the setting.

If your car sound system is installed as described in the installation instructions and your vehicle features the corresponding connection, the display brightness for day and night is switched by switching the vehicle lighting on or off.

AUX EDIT

Entering names for the rear AUX input in AUX mode. Length: 9 digits; characters: A-Z, 0-9.

- Press the > button (14) to open the sub-menu.
- Press the button < (5) / > (14) to change between the positions.

The character at the selected position flashes if selected.

- Press the button **↵** (16) / **↶** (2) to select a character at the selected location.
- Briefly press the **MENU•OK** button (15) to confirm the name entered.

TRAF

(only for tuner region "EUROPE")

Only possible in FM radio mode: Switching priority for traffic announcements on or off. Settings: ON, OFF.

- Press the **>** button (14) to open the sub-menu.
- Press the **>** button (14) to change between the settings.

RDS

(only for tuner region "EUROPE")

Only possible in FM radio mode: Switching RDS function on or off. Settings: ON, OFF.

- Press the **>** button (14) to open the sub-menu.
- Press the **>** button (14) to change between the settings.

Factory settings

Factory settings in the user menu:

ON VOLUME	LAST VOL
MUTE LVL	0
SENS	HI6
SCAN TIME	10
CLOCK	OFF
BEEP	ON
DIM DAY	15
DIM NIGHT	12
CDTEXT	OFF
12H/24H MODE	24H
CLOCKSET	00:00
TA VOL	20
RDS*	ON
REG*	ON
TRAF*	OFF

* Only in tuner region "EUROPE"

You can restore the original factory settings of the car sound system:

- Briefly press the **MENU•OK** button (15) to open the menu.
- Press the button **↵** (16) / **↶** (2) repeatedly until the "NORMSET" menu item is selected.
- Press and hold down the **MENU•OK** button (15) for longer than 4 seconds.

"NORM ON" briefly appears on the display. The car sound system automatically switches off and on again with the factory settings.

Note:

If you press the **MENU•OK** button (15) for less than 4 seconds, "NORM OFF" appears on the display and the current settings are retained.

Useful information

Warranty

We provide a manufacturer's warranty for products bought within the European Union. For devices purchased outside the European Union, the warranty terms issued by our respective responsible domestic agency are valid.

The warranty terms can be called up under www.blaupunkt.com or requested directly from:

Blaupunkt GmbH
Hotline
Robert-Bosch-Str. 200
D-31139 Hildesheim

Service

In some countries, Blaupunkt offers a repair and pick-up service.

Information about the availability of this service in your country can be found at www.blaupunkt.com.

If you want to take advantage of this service, you may request a pick-up service for your car sound system via the Internet.

Technical data

Voltage supply

Operating voltage: 10.5 - 14.4 V

Current consumption

In operation: 10 A
10 sec. after switch-off: < 3.5 mA

Amplifier

Output power: 4 x 26 watts sine at 14.4 V at 4 ohms.
4 x 50 watts max. power

Tuner

Wavebands in Europe/Thailand:

FM: 87.5 - 108 MHz
AM (MW): 531 - 1,602 kHz
LW (Europe only): 153 - 279 kHz

Wavebands in the US:

FM: 87.7 - 107.9 MHz
AM (MW): 530 - 1,710 kHz

Wavebands in South America:

FM: 87.5 - 107.9 MHz
AM (MW): 530 - 1,710 kHz

FM frequency response:

30 - 15,000 Hz

CD

Frequency response:

20 - 20,000 Hz

Pre-amp out

4 channels: 2 V

Input sensitivity

Rear-AUX-IN: 1.2 V / 10 kΩ
Front-AUX-IN: 500 mV / 6 kΩ
Tel/Nav input: 10 V / 1 kΩ

Dimensions and weight

W x H x D (mm): 182 x 53 x 155
Weight: approx. 1.30 kg

Subject to changes

DE – Einbauanleitung



Sicherheitshinweise

Für die Dauer der Montage und des Anschlusses beachten Sie bitte folgende Sicherheitshinweise.

- Minuspol der Batterie abklemmen! Dabei die Sicherheitshinweise des Kfz- Herstellers beachten.
- Beim Bohren von Löchern darauf achten, dass keine Fahrzeugteile beschädigt werden.
- Der Querschnitt des Plus- und Minuskabels darf 1,5 mm² nicht unterschreiten.

Fahrzeugeitige Stecker nicht an das Radio anschließen!

Die für Ihren Fahrzeugtyp erforderlichen Adapterkabel erhalten Sie im BLAUPUNKT-Fachhandel.

- Je nach Bauart kann Ihr Fahrzeug von dieser Beschreibung abweichen. Für Schäden durch Einbau- oder Anschlussfehler und für Folgeschäden übernehmen wir keine Haftung.

Sollten die hier aufgeführten Hinweise für Ihren Einbau nicht passen, so wenden Sie sich bitte an Ihren Blaupunkt-Fachhändler, Ihren Fahrzeughersteller oder unsere Telefon-Hotline.

Bei Einbau eines Amplifiers oder Changers müssen unbedingt erst die Gerätemassen angeschlossen werden, bevor die Stecker für die Line-In- oder Line-Out-Buchse kontaktiert werden.

Fremdgerätemassen dürfen nicht an der Autoradiomasse (Gehäuse) angeschlossen werden.

GB – Installation instructions



Safety instructions

When carrying out installation work and making connections please observe the following safety instructions:

- Disconnect the negative terminal of the battery! When doing so, please observe the vehicle manufacturer's safety instructions.
- Make sure you do not damage vehicle components when drilling any holes.
- The cross sections of the positive and negative cables must not be less than 1.5 mm².

Do not connect the vehicle's plug connectors to the radio!

You can obtain the adapter cable required for your vehicle type from any BLAUPUNKT dealer.

- Depending on the model, your vehicle may differ from the description provided here. We accept no responsibility for any damages due to incorrect installation or connection or for any consequential damages.

If the information provided here is not suitable for your specific installation requirements, please contact your Blaupunkt dealer, your vehicle manufacturer or our telephone hotline.

When installing an amplifier or changer, you must first connect the device earth connections before connecting the plugs for the line-in or line-out jacks.

Earth connection of external devices may not be connected to earth of car sound system (housing).

FR – Notice de montage



Consignes de sécurité

Respecter les consignes de sécurité suivantes pendant la durée du montage et du branchement.

- Débrancher le pôle (-) de la batterie ! Respecter les consignes de sécurité du constructeur automobile !
- Veiller à n'endommager aucune pièce du véhicule en perçant des trous.
- La section du câble (+) et (-) ne doit pas dépasser 1,5 mm².
- **Ne pas brancher les connecteurs du véhicule sur la radio !**
Les câbles d'adaptation nécessaires pour le type de véhicule sont disponibles auprès des revendeurs BLAUPUNKT.
- En fonction du modèle, votre véhicule peut différer de cette description. Nous déclinons toute responsabilité en cas de dommages causés par des erreurs de montage ou de connexion et en cas de dommages consécutifs.

Si les indications décrites ici ne s'appliquent au montage que vous voulez effectuer, adressez-vous à votre revendeur Blaupunkt, votre constructeur automobile ou notre service d'assistance téléphonique.

Pour le montage d'un amplificateur ou changeur, les masses d'appareil doivent être d'abord connectées avant de connecter les fiches pour les connecteurs Line In ou Line Out.

Les masses des appareils externes ne doivent pas être raccordées à la masse de l'autoradio (boîtier).

IT – Istruzioni di installazione



Note di sicurezza

Durante il montaggio e l'allacciamento osservate per favore le seguenti istruzioni sulla sicurezza.

- Staccate il polo negativo della batteria! Nel fare ciò osservate le istruzioni di sicurezza del fabbricante d'auto.
- Quando praticate dei fori, fate attenzione a non danneggiare nessuna parte dell'autovettura.
- La sezione dei cavi positivi e negativi non deve essere mai inferiore a 1,5 mm².
- Non collegate alla radio le spine in dotazione di autovettura!
- Richiedete ad un negoziante specializzato in articoli BLAUPUNKT il cavo di adattamento richiesto per il vostro modello di autovettura.
- A seconda del modello il Suo veicolo può differire da questa descrizione. Non forniamo garanzia per danni derivanti da errori di montaggio o di collegamento e per danni conseguenti.
- Se le indicazioni qui elencate non sono adatte al Suo montaggio, La preghiamo di rivolgervi al Suo rivenditore Blaupunkt, al fabbricante dell'auto o alla nostra hotline telefonica.

Quando vengono montati un amplificatore o un multilettore CD, bisogna innanzi tutto allacciare le masse degli apparecchi prima di eseguire la connessione delle spine con le prese line-in e line-out.

Le masse di altri apparecchi non devono essere collegate alla massa dell'autoradio (involucro).

NL – Inbowhandleiding



Adviezen voor de veiligheid

Wilt u dedurende het monteren en aansluiten de volgende veiligheidsadviezen in acht nemen.

- De minpool van de batterij afklemmen! De veiligheidsadviezen van de fabrikant in acht nemen.
- Bij het gaten boren erop letten dat geen voertuigonderdelen worden beschadigd.
- De dwarsdoorsnede van de plus- en minkabel mag niet minder dan 1,5 mm² zijn.
- **Stekker aan de voertuigkant niet aan de radio aansluiten!**

De voor uw voertuig vereiste adapterkabel is bij de BLAUPUNKT-vakhandel verkrijgbaar!

- Afhankelijk van de uitvoering kan uw auto afwijken van deze beschrijving. Voor schade door fouten in montage of aansluiting en schade als gevolg daarvan aanvaarden wij geen aansprakelijkheid.

Mochten de hier vermelde aanwijzingen voor de montage voor u niet van toepassing zijn, dan kunt u contact opnemen met uw Blaupunkt-vakhandel, uw autofabrikant of onze telefoon-hotline.

Bij inbouw van een versterker of cd-wisselaar moeten eerst de massacontacten van de apparaten worden verbonden voordat de stekkers voor de line-in- of line-out-bussen worden aangesloten.

De massa van andere apparaten mag niet aan de massa van de autoradio (huis) worden aangesloten.

SW – Monteringsanvisning



Skyddsanvisningar

Vänligen beakta följande skyddsanvisningar under pågående montage och anslutning.

- Lossa polskon från batteriets minuspol! Följ därvid fordonstillverkarens skyddsanvisningar.
- Se till att inga av fordonets komponenter skadas i samband med borrhning av hål.
- Plus- och minuskabeln's ledningsarea måste vara minst 1,5 mm².
- **Fordonets stickkontakt får inte anslutas till radion!**
Din BLAUPUNKT fackhandel tillhandahåller för resp fordonstyp erforderlig adapterkabel.
- Beroende på konstruktionstyp kan fordonet avvika från denna beskrivning. Vi frånsäger oss allt ansvar för skada eller följdskada pga. felaktig montering eller anslutning.

Om här givna monteringsanvisningar ej stämmer överens med faktiska förhållanden, vänligen kontakta Blaupunkt fackhandel, representant för fordonets tillverkare eller vår telefonkundtjänst.

Vid montering av förstärkare eller cd-växlare måste först apparatstommen jordas, innan stickpropparna ansluts till in- eller utgångarna (hylstag line-in resp line-out).

Jord från andra apparater får inte anslutas till bilradions jord (höljet).

ES – Instrucciones de instalación



Normas de seguridad

Durante el montaje y la conexión es imprescindible observar las siguientes normas de seguridad.

- Desemborne el polo negativo de la batería. Observe las normas de seguridad dadas por el fabricante del vehículo.
- Al perforar agujeros, asegúrese de no dañar ninguna pieza del vehículo.
- La sección transversal del cable positivo y del cable negativo no debe ser menor de 1,5 mm².
- **¡No conecte a la radio los conectores ubicados en el vehículo!**
Los cables adaptadores necesarios para su vehículo los encontrará en el comercio especializado en artículos de la marca BLAUPUNKT.
- Dependiendo del modelo, es posible que su vehículo varíe un poco con respecto a la descripción aquí dada. Tenga en cuenta que no asumimos ninguna responsabilidad por los daños debidos a un montaje o conexión incorrectos ni por los daños resultantes.

Si las instrucciones aquí dadas no son aptas para el montaje en su vehículo, póngase en contacto con su proveedor de artículos Blaupunkt o con el fabricante del vehículo, o llame a nuestro teléfono de atención al cliente.

En caso de montar un amplificador o un cambiadiscos, es necesario conectar la puesta a tierra de las unidades antes de establecer el contacto de los conectores para las hembrillas Line-In y Line-Out.

No deben conectarse masas de otros equipos a la masa de la radio (carcasa).

PT – Instruções de montagem



Instruções de segurança

Durante a montagem e a ligação do aparelho, queira respeitar as seguintes instruções de segurança.

- Separar o pólo negativo da bateria! Respeitar ao mesmo tempo as instruções de segurança do fabricante do automóvel.
- Quando se procede à furagem de buracos, prestar atenção para não serem danificadas quaisquer partes do veículo.
- As secções transversais dos cabos positivo e negativo não devem ser inferiores a 1,5 mm².
- **Não ligar as fichas existentes do lado do automóvel ao auto-rádio**
Os cabos adaptadores necessários para o seu automóvel podem ser adquiridos nos revendedores da BLAUPUNKT.
- O seu veículo pode divergir desta descrição em função do modelo. Não assumimos qualquer responsabilidade por erros de montagem ou de ligação nem por danos daí decorrentes.

Caso as presentes instruções não sejam adequadas para a montagem no seu veículo, dirija-se ao revendedor da Blaupunkt, ao fabricante do seu veículo ou à nossa linha verde.

No caso de montagem de um amplificador ou leitor multi-CD, é imprescindível ligar primeiro os aparelhos à terra antes de se conectar as fichas às tomadas Line In ou Line Out.

A massa de aparelhos externos não deve ser ligada à massa do auto-rádio (caixa).

DK – Monteringsvejledning



Sikkerhedshenvisninger

Under monteringen og tilslutningen skal følgende sikkerhedshenvisninger iagttages.

- Batteriets negative pol skal afbrydes! Herved skal bilfabrikantens sikkerhedshenvisninger iagttages.
- Vær opmærksom på, at ingen bildele ødelægges under boringen af huller.
- Tværsnittet af plus- og minuskablet må ikke underskride 1,5 mm².

• Bilens stik må ikke tilsluttes radioen!

De nødvendige adapterkabler til din biltype kan købes hos BLAUPUNKT-specialforretningen.

- Alt efter konstruktion kan bilen afvige fra denne beskrivelse. For skader på grund af monterings- eller tilslutningsfejl og for følgeskader overtager vi intet ansvar.

Hvis de her anførte henvisninger til monteringen ikke skulle passe, kontakt din Blaupunkt-specialforretning, bilfabrikanten eller vor telefon-hotline.

Ved montering af en forstærker eller et Multi CD-apparat skal apparaternes stel først tilsluttes, før stikkene for tilslutningerne Line-In eller Line-Out sættes i.

Eksterne enheders stelforbindelse må ikke sluttes til bilradioens stelforbindelse (kabinet).

PL – Instrukcja montażowa



Wskazówki bezpieczeństwa

Podczas montażu i podłączania należy przestrzegać poniższych wskazówek bezpieczeństwa.

- Odłączyć biegun ujemny akumulatora! Przestrzegać wskazówek bezpieczeństwa producenta pojazdu.
- Przy wierceniu otworów uważać, aby nie uszkodzić kogoś z urządzeń pokładowych pojazdu.
- Przekrój kabla plusowego i minusowego nie może być mniejszy niż 1,5 mm².

• Nie podłączać wtyczek samochodu do radia!

Odpowiedni dla danego typu pojazdu przewód-adaptacji można nabyć u autoryzowanego sprzedawcy produktów BLAUPUNKT.

- Zależnie od marki i modelu, konstrukcja Państwa pojazdu może niekiedy odbiegać od podanego tu opisu. Firma Blaupunkt wyklucza wszelką odpowiedzialność za szkody spowodowane błędnym montażem i instalacją urządzeń.

W przypadku, gdy podane tu wskazówki nie znajdują zastosowania w Państwa pojeździe, prosimy skontaktować się z autoryzowanym sprzedawcą produktów Blaupunkt, producentem pojazdu lub zadzwonić do naszej infolinii.

Przy montażu wzmacniacza lub zmieniaarki należy koniecznie najpierw podłączyć masy urządzeń, zanim połączona zostanie wtyczka do gniazda Line-In lub Line-Out.

Do masy radioodtworacza (obudowa) nie wolno podłączać masy obcych urządzeń.

CZ – Návod k montáži



Bezpečnostní pokyny

Během montáže a připojení dodržujte prosím následující bezpečnostní pokyny.

- Odpojte záporný pól akumulátoru! Přitom dodržujte bezpečnostní pokyny výrobce vozidla.
- Při vrtání otvorů dbejte na to, abyste nepoškodili žádné díly vozidla.
- Průřez kabelu plus a minus pólu musí být minimálně 1,5 mm².
- **Konektory od vozidla nepřipojujte k rádiu!**

Adaptérový kabel potřebný pro vaše vozidlo obdržíte ve specializované prodejně BLAUPUNKT.

- V závislosti na konstrukci se může postup u vašeho vozidla od zde popsaného postupu lišit. Za škody způsobené montáží nebo připojením nepřebíráme žádné ručení.

Pokud zde uvedené pokyny pro montáž neodpovídají vašemu vozidlu, obraťte se na specializovaného prodejce Blaupunkt, výrobce vozidla nebo naši horkou linku.

Při montáži zesilovače nebo měničů, předtím než budou konektory zapojeny do zdířek Line-in nebo Line-out, musí být nejprve bezpodmínečně připojeny kostry přístrojů.

Kostry jiných přístrojů nesmí být připojeny na kostru autorádia (kryt přístroje).

SF – Asennusohjeet



Turvallisuusohjeita

Noudata asennus- ja liitântätöiden yhtedessä seuraavia turvallisuusohjeita.

- Irrota akun miinusnapakytkennät! Noudata ajoneuvon valmistajan antamia turvaohjeita.
- Reikiä poratessasi huolehdi siitä, etteivät ajoneuvon osat vahingoitu.
- Plus- ja miinuskaapelin poikkipinta ei saa alittaa 1,5 mm² mittaa.

Älä kytke auton pistoketta radioon!

Saat autoosi sopivan sovitinjohdon BLAUPUNKT-kauppiaaltasi.

- Autosi saattaa poiketa tästä kuvauksesta. Emme vastaa asennus- tai kytkentävirheiden aiheuttamista vaurioista tai niiden seurauksista.

Jos tässä annetut ohjeet eivät sovellu asennustilanteeseen, kääny Blaupunkt-kauppiiaan, ajoneuvon valmistajan tai puhelinpalvelumme puoleen.

Jos asennetaan vahvistin tai CD-vaihtaja, tällöin on ehdottomasti kytkettävä ensin laitteiden maadoitukset, ennen kuin linjatulo- tai linjalähtöliitântöjen pistokkeet liitetään paikoilleen.

Muiden laitteiden maadoituksia ei saa kytkeä autoradion maadoitukseen (kotelo).

HU – Beszerelési útmutató



Biztonsági előírások

A beszerelési és csatlakoztatási műveletek során kérjük, tartsa be az alábbi biztonsági utasításokat:

- Csatlakoztassa le az akkumulátor negatív kábelét! Ennek végrehajtása közben vegye figyelembe a jármű gyártójának biztonsági utasításait.
- Ügyeljen arra, hogy a furatok készítésekor ne rongálja meg a jármű alkatrészeit.
- A pozitív és negatív kábelek keresztmetszete ne legyen kisebb, mint 1,5 mm².
- **Ne használja a jármű csatlakozót a rádióhoz!**
Bármely BLAUPUNKT kereskedőnél beszeresheti a jármű típusának megfelelő illesztőkábelt.
- A modelltől függően, az Ön járműve eltérhet az itt szereplő leírástól. Nem vállalunk felelősséget a nem megfelelő beszerelésből vagy csatlakoztatásból fakadó vagy egyéb ebből következő bármilyen károsodásért.

Ha az itt leírt információk nem felelnek meg az Ön egyedi beszerelési igényeinek, akkor vegye fel a kapcsolatot Blaupunkt márkakereskedőjével, a jármű gyártójával vagy hívja telefonos ügyfélszolgálatunkat.

- Erősítő vagy CD-váltó beszerelésekor előbb a készülék test csatlakozásait kell csatlakoztatni, majd csak ezután a bemeneti és kimeneti csatlakozódugókat.

A külső eszközök test csatlakozásait nem lehet az autós hangsugárzó rendszer testhez (házhöz) csatlakoztatni.

RU – Инструкция по установке



Указания по технике безопасности

Во время монтажа и подсоединения соблюдайте, пожалуйста, следующие указания по технике безопасности.

- Отсоедините минусовую клемму аккумулятора! Соблюдайте при этом правила техники безопасности завода-изготовителя Вашего автомобиля.
- При сверлении отверстий следите за тем, чтобы не повредить компоненты автомобиля.
- Сечение плюсового/минусового кабелей должен быть не меньше 1,5 мм².
- **Не включайте в аудиосистему автомобильные штекеры!**
Необходимые для Вашего типа автомобиля адаптерные кабели Вы можете приобрести в авторизованном сервисном центре Blaupunkt.
- Ваш автомобиль может - в зависимости от конструкции - отклоняться от данного описания. Завод-изготовитель аудиосистемы не несет ответственности за повреждения и за ошибок при монтаже или подключении, а также за косвенный ущерб.
- Если перечисленные здесь указания для Ваших условий монтажа не подходят, то обратитесь, пожалуйста, в авторизованный сервисный центр Blaupunkt или продавцу Вашего автомобиля.

При установке усилителя перед соединением штекеров гнезд линейного входа и выхода сначала нужно в обязательном порядке подключить массы устройств.

Запрещается подключение масс посторонних устройств к массе аудиосистемы (корпусу).

GR – Οδηγίες Εγκατάστασης



Οδηγίες Ασφαλείας

Όταν εκτελείται εργασία εγκατάστασης και κάνετε τις συνδέσεις, παρακαλούμε παρατηρήστε τις ακόλουθες οδηγίες ασφαλείας:

- Αποσυνδέστε το αρνητικό τερματικό από την μπαταρία! Όταν γίνεται αυτό, παρακαλώ παρατηρήστε τις οδηγίες ασφαλείας του κατασκευαστή του αυτοκινήτου.
- Σιγουρευτείτε ότι δεν κάνετε ζημιά στα εξαρτήματα του αυτοκινήτου όταν ανοίγετε τρύπες.
- Οι διατομές των θετικών και αρνητικών καλωδίων δεν πρέπει να είναι μικρότερες από 1,5 mm².
- **Μην συνδέετε τα βύσματα του οχήματος με το ραδιόφωνο!**
Μπορείτε να λάβετε ένα καλώδιο-προσαρμογέα που χρειάζεται για το όχημά σας από έναν αντιπρόσωπο της BLAUPUNKT.
- Ανάλογα με το μοντέλο, το όχημά σας μπορεί να διαφέρει από την περιγραφή που παρέχεται εδώ. Δεν δεχόμαστε καμία ευθύνη για οποιοσδήποτε ζημιές που οφείλονται σε λανθασμένη εγκατάσταση ή σύνδεση ή για οποιοσδήποτε άλλες ζημιές.

Εάν οι πληροφορίες που παρέχονται εδώ, δεν είναι οι κατάλληλες για τις συγκεκριμένες απαιτήσεις εγκατάστασης, παρακαλούμε επικοινωνήστε με τον αντιπρόσωπο της Blaupunkt, τον κατασκευαστή του οχήματος ή την τηλεφωνική μας γραμμή.

Όταν εγκαθιστάτε έναν ενισχυτή ή εναλλαγέα, πρέπει πρώτα να συνδέσετε τις συνδέσεις της γείωσης πριν συνδέσετε τα βύσματα για τις εισόδους ή εξόδους.

Σύνδεση γείωσης των εξωτερικών συσκευών μπορεί να μην συνδεθεί στη γείωση του ηχητικού συστήματος του αυτοκινήτου (τοποθέτηση).

Mitgelieferte Montage- und Anschlusssteile

Supplied Mounting Hardware

Matériel de montage fourni

Componenti di fissaggio comprese nella fornitura

Meegeleverde montagematerialen

Medföljande monteringsdetaljer

Ferretería de montaje suministrada

Elementos de fixação fornecidos

Medleverede monterings- og tilslutningsdele

Dołączone części montażowe i połączeniowe

Přiložené montážní díly a přípojné svorky

Toimitukseen kuuluvat asennus- ja kytkentäosat

A csomag részét képező szerelőkeret

Поставляемые в комплекте компоненты для установки и подсоединения

Παρεχόμενα Υλικό Τοποθέτησης

Toronto 400 BT (7 649 035 110)

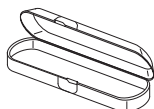
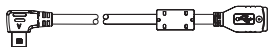
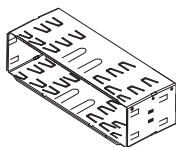

Toronto 400 BT (7 649 036 010)

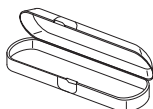
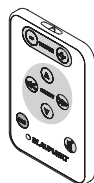
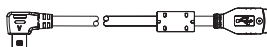
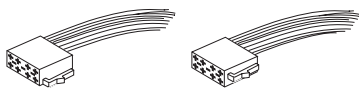
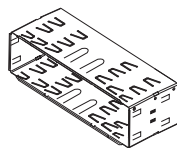

Als Sonderzubehör erhältlich
Available as an optional accessory
Disponibile en option
Reperibili come accessori extra
Als speciale accessoire verkrijgbaar
Tillval

De venta como accesorios especiales
Disponíveis como acessórios opcionais
Fås som specialtilbehør
Dostępne jako wyposażenie dodatkowe
Jako zvláštní příslušenství můžete obdržet

Saatavana lisätarvikkeena
Kiegészítő tartozékként beszerezhető
Поставляется как дополнительная принадлежность
Διατίθεται ως προαιρετικό αξεσουάρ

Preamp./Sub./Center - out cable

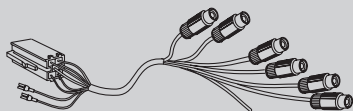

7 607 001 512

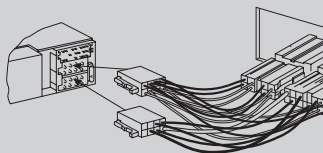

7 607 621 ...

Einbausätze • Installation kits •
Kits de montage • Set di montaggio •
Inbouwsets • Monteringssetser •
Juegos de montaje • Kits de montagem •
Indbygningssæt • Zestawy montażowe •
Montážní soupravy • Asennussarjat •
Beépítő-készlet • Установочные комплекты •
Κιτ εγκατάστασης

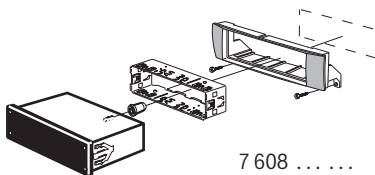

1.

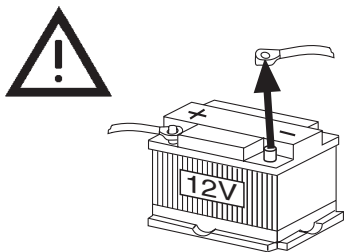

2.

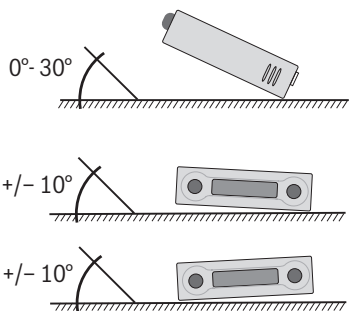

3.

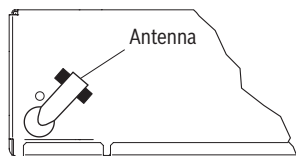

Antenna connection

4.

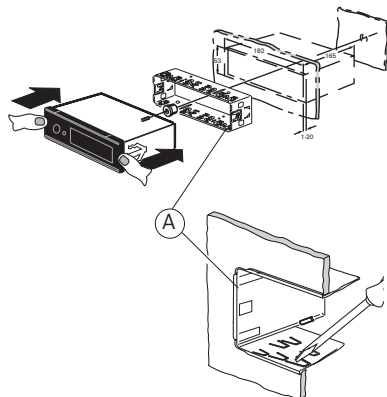

5. Ausbau • Removal • Démontage •
Smontaggio • Demontage • Urmontering •
Desmontaje • Desmontagem •
Udbygning • Demontaž • Demontáž •
Irrotus • Eltávolítás • Демонтаж •
Αφαίρεση

1.

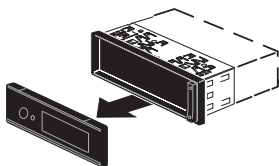

2.

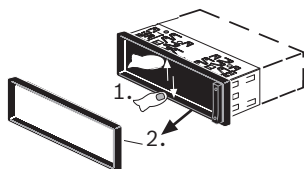

3.

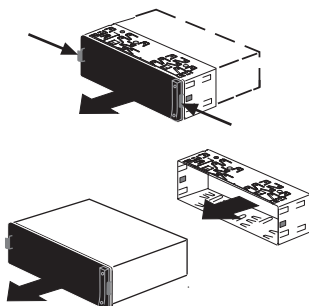

6.

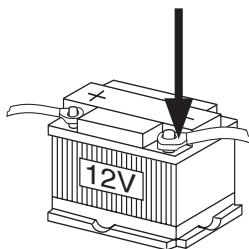

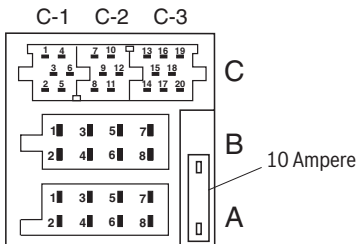

- * Aut. antenna
 FB +12V / RC +12V
 +12V Amplifier

max. 150 mA

A		B	
1	NC	1	Speaker out RR+
2	Radio Mute	2	Speaker out RR-
3	NC	3	Speaker out RF+
4	Permanent +12V	4	Speaker out RF-
5	Aut. antenna *	5	Speaker out LF+
6	Illumination	6	Speaker out LF-
7	Kl.15/Ignition	7	Speaker out LR+
8	Masse/GND	8	Speaker out LR-

C1		C2		C3	
1	Line Out LR	7	NC	13	CDC-Data In
2	Line Out RR	8	NC	14	CDC-Data Out
3	Line Out / Ground	9	Radio Mute	15	Permanent +12V
4	Line Out LF	10	SW Supply - RC +12V *	16	SW Supply +12V *
5	Line Out RF	11	Remote Control	17	Bus - Masse/GND
6	SW Supply +12V Amp. *	12	RC - GND	18	CDC/AUX1 Audio IN-GND
				19	CDC/AUX1 Audio IN-L
				20	CDC/AUX1 Audio IN-R

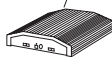

Amplifier

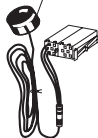

CD-Changer / AUX IN

Preamp - Out cable

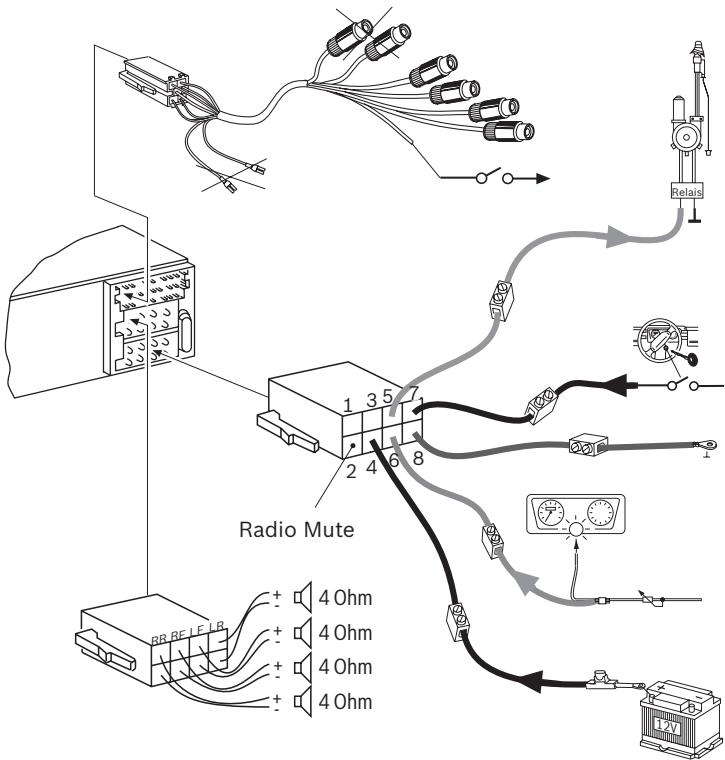

Änderungen vorbehalten! • Subject to changes! • Sous réserve de modifications! •
 Modifiche riservate! • Wijzigingen voorbehouden! • Ändringar förbehålles! • Modificaciones reservadas!
 • Sob reserva de alterações! • Ret til ændringer forbeholdes! • Zmiany techniczne zastrzeżone! • Změny
 vyhrazeny! • Oikeus muutoksiin pidätetään! • Podložno promjenama! • Завод-изготовитель оставляет за
 собой право на внесение изменений! • Μπορεί να αλλάξει!

© 2008 All rights reserved by Blaupunkt. This material may be reproduced, copied or distributed for personal use only.

This product is protected by certain intellectual property rights of Microsoft. Use or distribution of such technology outside of this product is prohibited without a license from Microsoft.

Country:	Phone:	Fax:	WWW:
Germany	(D) 0180-5000225	05121-49 4002	http://www.blaupunkt.com
Austria	(A) 01-610 39 0	01-610 39 391	
Denmark	(DK) 44 898 360	44-898 644	
Finland	(FIN) 09-435 991	09-435 99236	
Great Britain	(GB) 01-89583 8880	01-89583 8394	
Greece	(GR) 210 94 27 337	210 94 12 711	
Ireland	(IRL) 01-46 66 700	01-46 66 706	
Italy	(I) 02-369 62331	02-369 62464	
Luxembourg	(L) 40 4078	40 2085	
Norway	(N) +47 64 87 89 60	+47 64 87 89 02	
Portugal	(P) 2185 00144	2185 00165	
Spain	(E) 902 52 77 70	91 410 4078	
Sweden	(S) 08-7501850	08-7501810	
Switzerland	(CH) 01-8471644	01-8471650	
Czech. Rep.	(CZ) 02-6130 0446	02-6130 0514	
Hungary	(H) 76 889 704	-	
Poland	(PL) 0800-118922	022-8771260	
Turkey	(TR) 0212-335 07 23	0212-346 00 40	
USA	(USA) 800-950-2528	708-6817188	
Brasil (Mercosur)	(BR) 0800 7045446	+55-19 3745 2773	
Malaysia (Asia Pacific)	(MAL) +604-6382 474	+604-6413 640	

01/09 - CM-BP/PRM-CR (DE, GB, FR, IT, NL, SW, ES, PT, DK, PL, CZ, SF, HU, RU, GR)

Passport

Name:

Type: **7 649...**

Serial no.: **BP**

 **BLAUPUNKT**

