

---

# Acer AL1715

## Service Guide

Service guide files and updates are available on the CSD web; for more information, please refer to <http://csd.acer.com.tw>

## **Copyright**

Copyright © 2003 by Acer Incorporated. All rights reserved. No part of this publication may be reproduced, transmitted, transcribed, stored in a retrieval system, or translated into any language or computer language, in any form or by any means, electronic, mechanical, magnetic, optical, chemical, manual or otherwise, without the prior written permission of Acer Incorporated.

## **Disclaimer**

The information in this guide is subject to change without notice. Acer Incorporated makes no representations or warranties, either expressed or implied, with respect to the contents hereof and specifically disclaims any warranties of merchantability or fitness for any particular purpose. Any Acer Incorporated software described in this manual is sold or licensed "as is". Should the programs prove defective following their purchase, the buyer (and not Acer Incorporated, its distributor, or its dealer) assumes the entire cost of all necessary servicing, repair, and any incidental or consequential damages resulting from any defect in the software.

Acer is a registered trademark of Acer Corporation.

Intel is a registered trademark of Intel Corporation.

Pentium and Pentium II/III are trademarks of Intel Corporation.

Other brand and product names are trademarks and/or registered trademarks of their respective holders.

---

## Conventions

The following conventions are used in this manual

SCREEN MESSAGES	Denotes actual messages that appear on screen.
NOTE	Gives bits and pieces of additional information related to the current topic.
WARNING	Alerts you to any damage that might result from doing or not doing specific actions.
CAUTION	Gives precautionary measures to avoid possible hardware or software problems.
IMPORTANT	Remind you to do specific actions relevant to the accomplishment of procedures.

## Preface

Before using this information and the product it supports, please read the following general information.

**1.** This Service Guide provides you with all technical information relating to the BASIC CONFIGURATION decided for Acer's "global" product offering. To better fit local market requirements and enhance product competitiveness, your regional office MAY have decided to extend the functionality of a machine (e.g. add-on card, modem, or extra memory capability). These LOCALIZED FEATURES will NOT be covered in this generic service guide. In such cases, please contact your regional offices or the responsible personnel/channel to provide you with further technical details.

**2.** Please note WHEN ORDERING FRU PARTS, that you should check the most up-to-date information available on your regional web or channel. If, for whatever reason, a part number change is made, it will not be noted in the printed Service Guide. For ACER-AUTHORIZED SERVICE PROVIDERS, your Acer office may have a DIFFERENT part number code to those given in the FRU list of this printed Service Guide. You MUST use the list provided by your regional Acer office to order FRU parts for repair and service of customer machines.

---

## **WARNING: (FOR FCC CERTIFIED MODELS)**

**NOTE:** This equipment has been tested and found to comply with the limits for a Class B digital device, pursuant to Part 15 of the FCC Rules. These limits are designed to provide reasonable protection against harmful interference in a residential installation. This equipment generates, uses and can radiate radio frequency energy, and if not installed and used in accordance with the instructions, may cause harmful interference to radio communications. However, there is no guarantee that interference will not occur in a particular installation. If this equipment does cause harmful interference to radio or television reception, which can be determined by turning the equipment off and on, the user is encouraged to try to correct the interference by one or more of the following measures:

1. Reorient or relocate the receiving antenna.
2. Increase the separation between the equipment and receiver.
3. Connect the equipment into an outlet on a circuit different from that to which the receiver is connected.
4. Consult the dealer or an experienced radio/TV technician for help.

## **NOTICE:**

1. The changes or modifications not expressly approved by the party responsible for compliance could void the user's authority to operate the equipment.
2. Shielded interface cables and AC power cord, if any, must be used in order to comply with the emission limits.
3. The manufacturer is not responsible for any radio or TV interference caused by unauthorized modification to this equipment. It is the responsibility of the user to correct such interference.

As an ENERGY STAR® Partner our company has determined that this product meets the ENERGY STAR® guidelines for energy efficiency.

## **WARNING:**

To prevent fire or shock hazard, do not expose the monitor to rain or moisture. Dangerously high voltages are present inside the monitor. Do not open the cabinet. Refer servicing to qualified personnel only.

## PRECAUTIONS

- Do not use the monitor near water, e.g. near a bathtub, washbowl, kitchen sink, laundry tub, swimming pool or in a wet basement.
- Do not place the monitor on an unstable trolley, stand, or table. If the monitor falls, it can injure a person and cause serious damage to the appliance. Use only a trolley or stand recommended by the manufacturer or sold with the monitor. If you mount the monitor on a wall or shelf, use a mounting kit approved by the manufacturer and follow the kit instructions.
- Slots and openings in the back and bottom of the cabinet are provided for ventilation. To ensure reliable operation of the monitor and to protect it from overheating, be sure these openings are not blocked or covered. Do not place the monitor on a bed, sofa, rug, or similar surface. Do not place the monitor near or over a radiator or heat register. Do not place the monitor in a bookcase or cabinet unless proper ventilation is provided.
- The monitor should be operated only from the type of power source indicated on the label. If you are not sure of the type of power supplied to your home, consult your dealer or local power company.
- The monitor is equipped with a three-pronged grounded plug, a plug with a third (grounding) pin. This plug will fit only into a grounded power outlet as a safety feature. If your outlet does not accommodate the three-wire plug, have an electrician install the correct outlet, or use an adapter to ground the appliance safely. Do not defeat the safety purpose of the grounded plug.
- Unplug the unit during a lightning storm or when it will not be used for long periods of time. This will protect the monitor from damage due to power surges.
- Do not overload power strips and extension cords. Overloading can result in fire or electric shock.
- Never push any object into the slot on the monitor cabinet. It could short circuit parts causing a fire or electric shock. Never spill liquids on the monitor.
- Do not attempt to service the monitor yourself; opening or removing covers can expose you to dangerous voltages and other hazards. Please refer all servicing to qualified service personnel
- To ensure satisfactory operation, use the monitor only with UL listed computers which have appropriate configured receptacles marked between 100 - 240V AC, Min. 3.5A.
- The wall socket shall be installed near the equipment and shall be easily accessible.
- For use only with the attached power adapter (output 12V DC) which have **UL, CSA** listed license

---

## **SPECIAL NOTES ON LCD MONITORS**

The following symptoms are normal with LCD monitor and do not indicate a problem.

### **NOTES**

- Due to the nature of the fluorescent light, the screen may flicker during initial use. Turn off the Power Switch and then turn it on again to make sure the flicker disappears.
- You may find slightly uneven brightness on the screen depending on the desktop pattern you use.
- The LCD screen has effective pixels of 99.99% or more. It may include blemishes of 0.01% or less such as a missing pixel or a pixel lit all of the time.
- Due to the nature of the LCD screen, an afterimage of the previous screen may remain after switching the image, when the same image is displayed for hours. In this case, the screen is recovered slowly by changing the image or turning off the Power Switch for hours.

# Table of Contents

<b>Chapter 1</b>	<b>Monitor Features</b>	<b>6</b>
	Monitor Features	8
	Factory Preset Timing Table	10
	Block Diagram	11
	Main board Diagram	12
	Software Flowchart	13
	Main board Layout	15
	Inverter Board Layout	17
	Front Bezel	18
	Rear Bezel	19
<b>Chapter 2</b>	<b>Operating Instructions</b>	<b>20</b>
	External Controls	20
	Front Panel Controls	20
	OSD Menu	22
	Hot-Key Menu	25
	OSD Message	26
	LOGO	27
<b>Chapter 3</b>	<b>Machine Disassembly</b>	<b>28</b>
<b>Chapter 4</b>	<b>Troubleshooting</b>	<b>31</b>
<b>Chapter 5</b>	<b>Connector Information</b>	<b>34</b>
<b>Chapter 6</b>	<b>FRU (Field Replacement Unit) List</b>	<b>35</b>
	Exploded Diagram	35
<b>Chapter 7</b>	<b>Schematic Diagram</b>	<b>40</b>
	Analog Input	40
	Input	41
	Scaler TSU16AK	42
	Panel Interface	43
	MCU	44
<b>Appendix</b>	<b>Online Support Information</b>	<b>45</b>



## Monitor Features

		SAMSUNG
LCD Panel	Driving system	TFT Color LCD
	Size	43.2cm(17.0")
	Pixel pitch	0.264mm(H) x 0.264mm(V)
	Brightness	300cd/m <sup>2</sup> (Typical)
	Contrast	500:1(Typical)
	Viewable angle	150° (H) 135° (V)
	Response time	12ms
Input	Video	R, G, B Analog Interface
		Digital (Dual-Input Model)
	H-Frequency	30KHz – 80KHz
	V-Frequency	55-75Hz
Display Colors		16.2M Colors
Dot Clock		135MHZ
Max. Resolution		1280 x 1024 @75Hz
Plug & Play		VESA DDC1/2B™
EPA ENERGY STAR®	ON Mode	≤45W
	OFF Mode	≤3W
Input Connector		D-Sub 15pin
		DVI-D 24pin (Dual-Input Model)
Input Video Signal		Analog:0.7Vp-p(standard),75 OHM, Positive
		Digital signal (Dual-Input Model)
Maximum Screen Size		Horizontal: 337.92mm
		Vertical: 270.34mm
Power Source		100~264VAC,47~63HZ
Environmental Considerations		Operating Temp: 5° to 50°C Storage Temp: -20° to 65°C Operating Humidity: 10% to 85%
Dimensions		430(W)×445(H)×152(D) mm
Weight (N. W.)		4.2kg Unit (net)

External Controls	Switch	<ul style="list-style-type: none"> <li>• Auto Adjust Key</li> <li>• &lt;/ Volume down (option)</li> <li>• &gt;/ Volume up (option)</li> <li>• Power Button</li> <li>• MENU/ Exit</li> </ul>
External Controls	Functions	<ul style="list-style-type: none"> <li>• Contrast</li> <li>• Brightness</li> <li>• Focus</li> <li>• Clock</li> <li>• H.Position</li> <li>• V.Position</li> <li>• Language</li> <li>• Input signal Selection</li> <li>• Auto configuration (Analog model only)</li> <li>• (Warm) Color</li> <li>• (Cool) Color</li> <li>• RGB Color temperature</li> <li>• Reset</li> <li>• OSD position /timeout</li> <li>• Display information</li> <li>• Exit</li> </ul>
Power Consumption (Maximum)		45 Watts
Regulatory Compliance		CUL, FCC, VCCI, CCC, MPRII, CE, TÜV/GS, CE, TCO'99, ISO13406-2

## Factory Preset Timing Table

STANDARD		RESOLUTION	HORIZONTAL FREQUENCY(KHz)	VERTICAL FREQUENCY(Hz)
VESA	VGA	640 × 480	31.469	59.940
		640 × 480	37.500	75.000
	SVGA	800 × 600	37.879	60.317
		800 × 600	46.875	75.000
	XGA	1024 × 768	48.363	60.004
		1024 × 768	56.476	70.069
		1024 × 768	60.023	75.029
	SXGA	1280 × 1024	64.000	60.000
		1280 × 1024	80.000	75.000
	IBM	DOS	720 × 400	31.469
MAC	XGA	1024 × 768	48.780	60.001
		1024 × 768	60.241	74.927

## Monitor Block Diagram

The LCD MONITOR contains a main board, an inverter/power board, keypad board and audio board which house the flat panel control logic, brightness control logic and DDC.

The Inverter board will drive the backlight of panel.

The Power will provide the 12V DC-power to inverter board and main board.

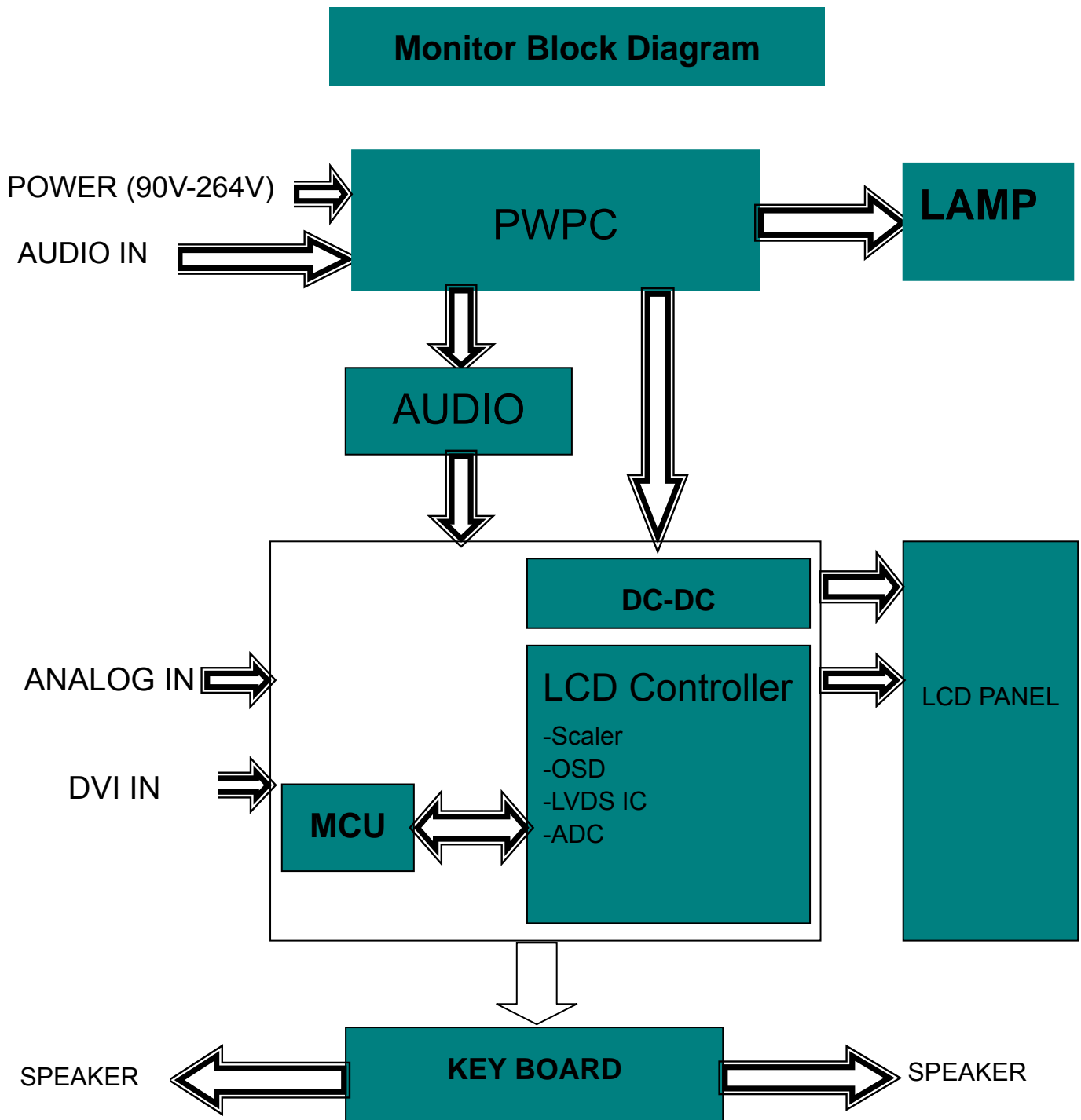

# MAIN BOARD DIAGRAM

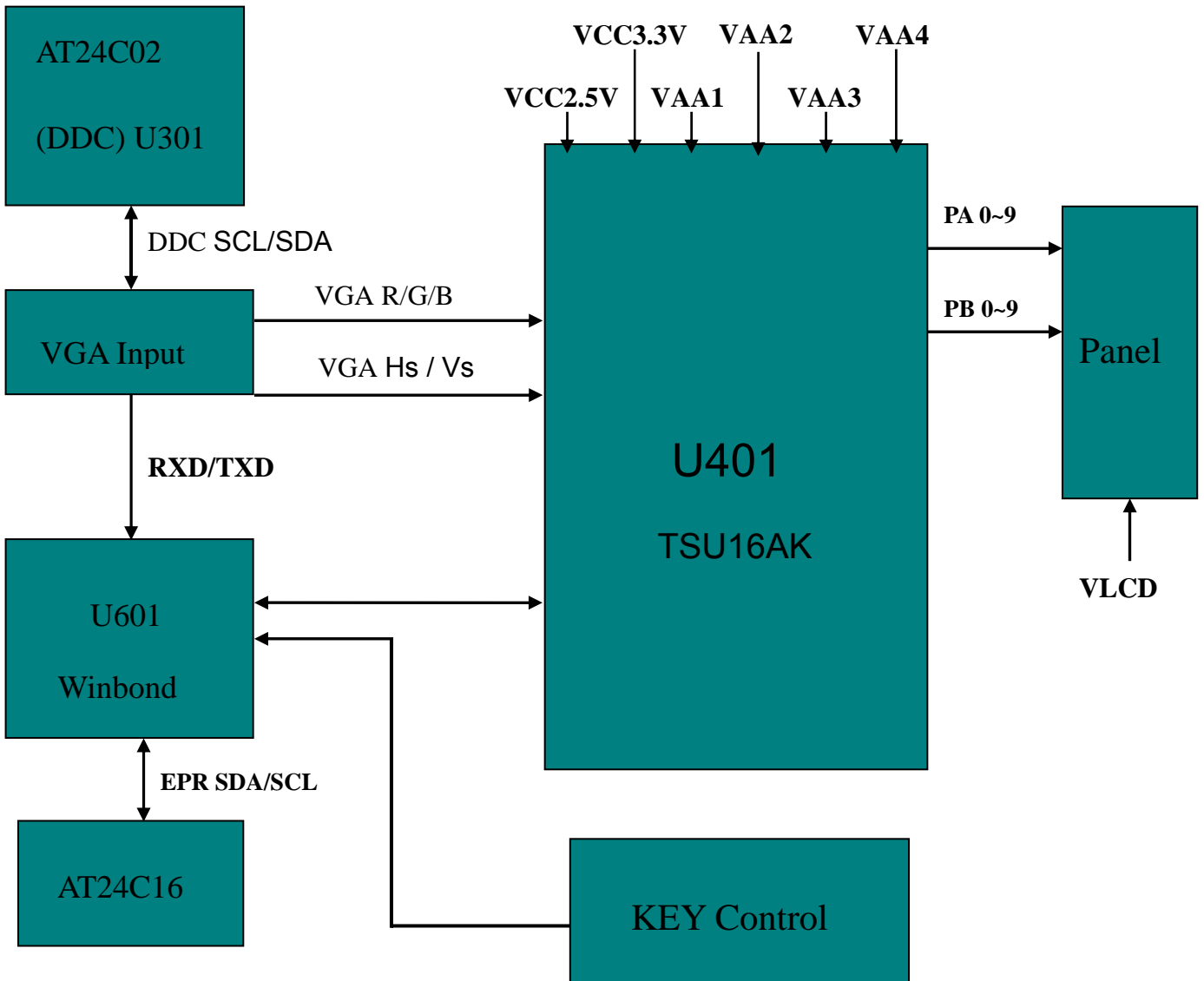

# Software Flow Chart

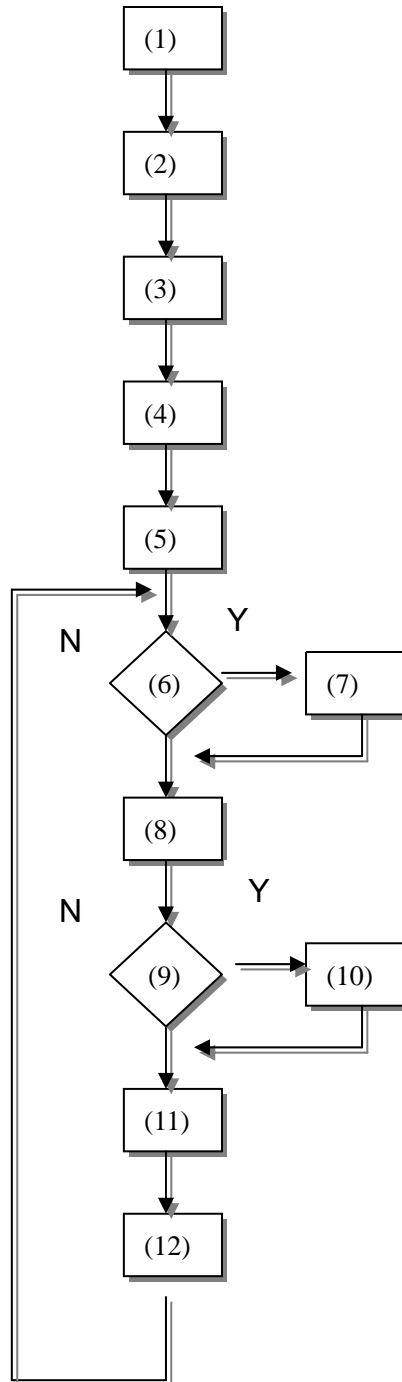

- 
1. Initialize MCU settings, including I/O, Timer, ISR and Serial Port settings.
  2. Read EEPROM content to recover monitor settings, including brightness, contrast, color temperature and OSD position....etc.
  3. Initialize system variable, including system flag, OSD timeout counter, burin mode status... etc.
  4. Initialize OSD menu variable for user operation
  5. Initialize device on the board, now only MST scaler chip will be initialized
  6. Check if system is in power off status from first AC power up. If yes, then go to 7, else go to 8.
  7. If yes, system will be forced to enter power off status
  8. Mode detection
  9. Check if input timing has been changed, if yes then go to 10, else go to 11
  10. Setup MST scaler for display according input timing
  11. OSD handler for OSD operation.
  12. Debug handler, only debug only

# Monitor Board Layout

715L1150-1-ACE  
 SILKSCREEN TOP Date:2004/03/20  
 BY : MSTARSEMI CO. TEL:02-8792-7586 EXT:524

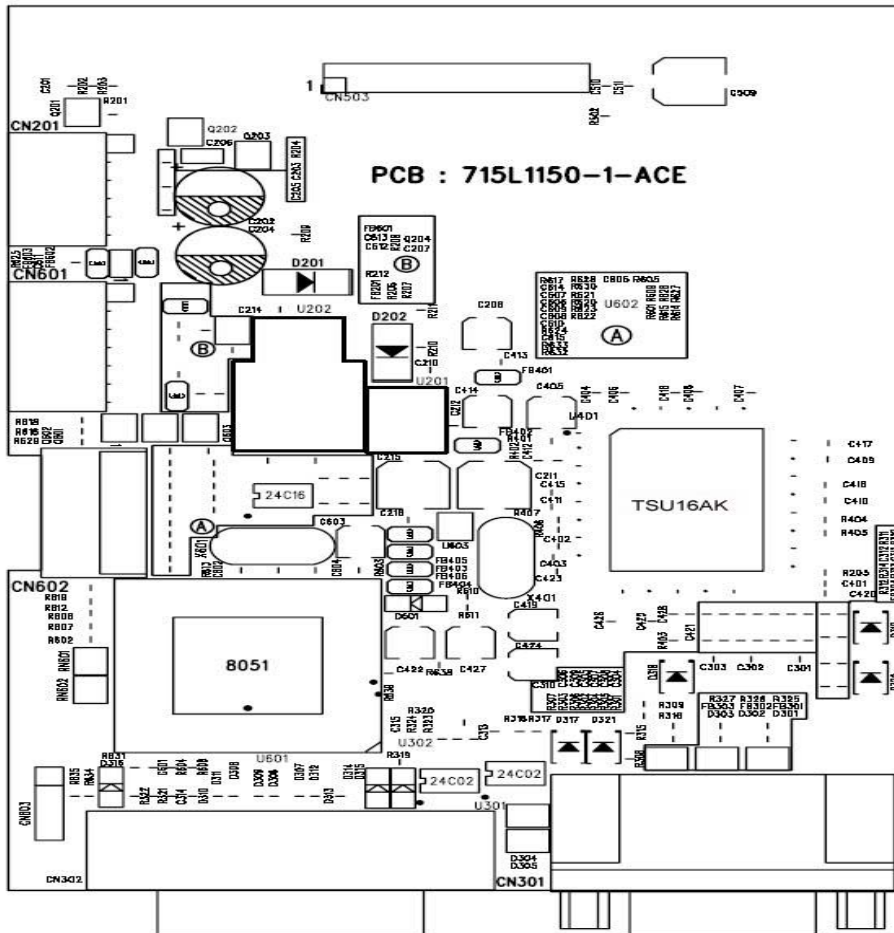

Item	Description
X401	CRYSTAL 14.318MHzHC-49U
X601	20MHz
U201	RT9164A18PG S0T-223
U202	AIC1084-33CM
U301	M24C02-WMN6T SMT
U401	TSU16AK pqfp-128
U601	W78E65P-40
CN201	HEADER 2*6P
CN301	D-SUB 15PIN
CN302	3 PIN
CN503	PIN HEADER 24P 2.0mm
CN601	PIN EADER
CN602	WAFER 16PIN 2.0mm DIP
RN601	CHIP AR 8P4R 10KOHM +5
RN602	CHIP AR 8P4R 10KOHM +5



## Inverter Board Layout

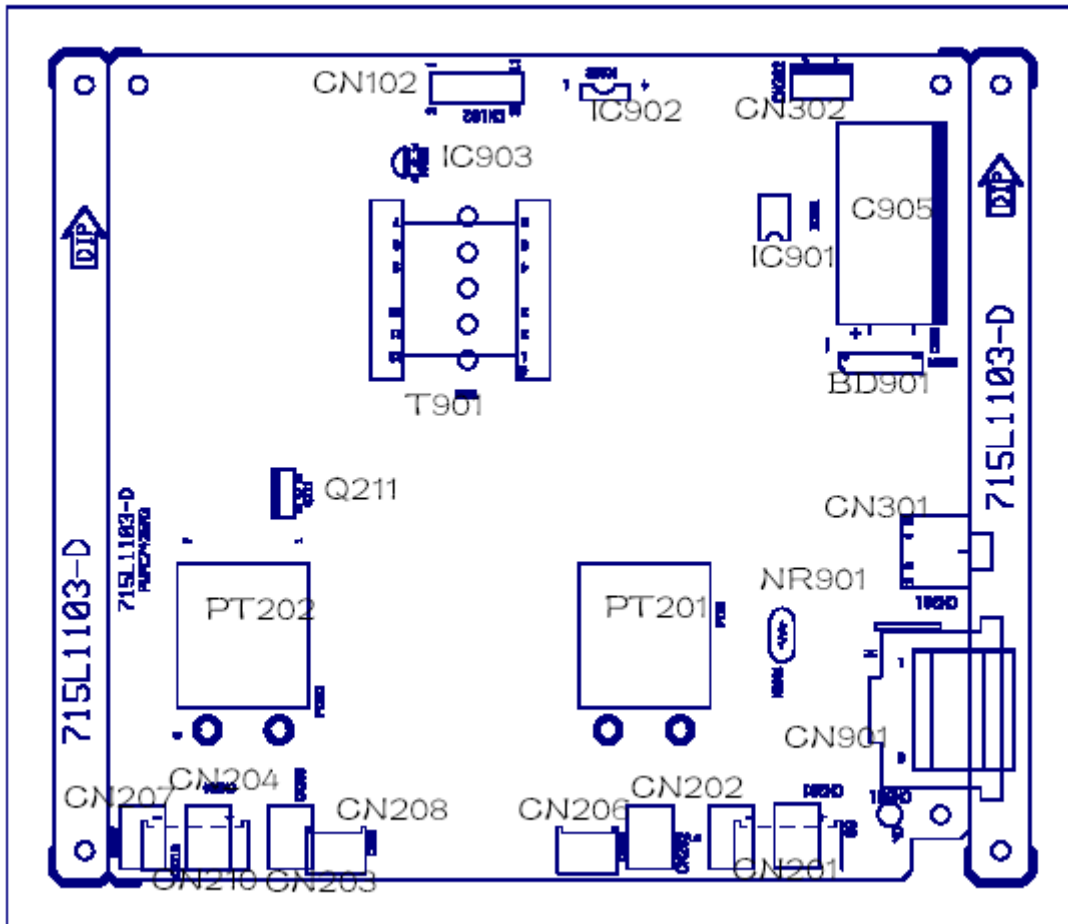

Item	Description
PT201	1.5MM RIVET
PT202	1.5MM RIVET
IC901	SG6841D BY SYSTEM
IC902	PC123 Y82
IC903	HTL431
CN102	HEADER 2*6P
CN201	WAFER
CN202	WAFER
CN203	CONN.2P R/A 87210-0236 DIP
CN204	WAFER
CN301	PHONE JACK(Only for SPK)
CN302	3 PIN
BD901	BRIDGE 2KBP06M
NR901	8 OHM NCTR
C905	100UF +-20% 400V
T901	X'FMR
Q211	2SC5706 DIP SANYO

## Front Bezel

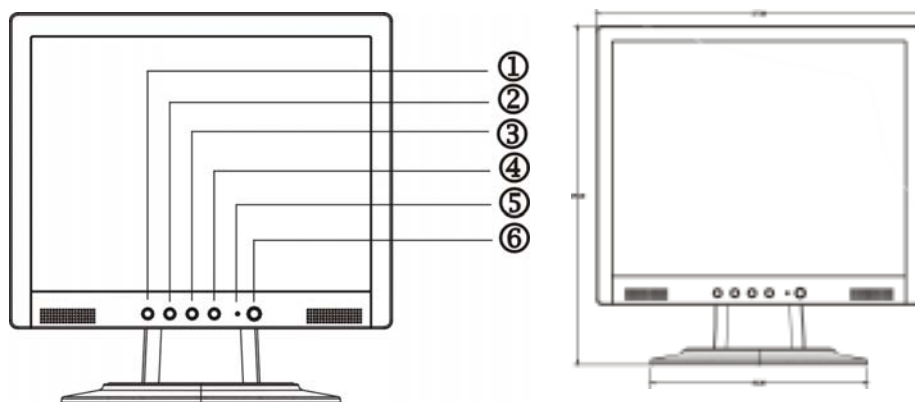

Item	Description
1	Auto Adjust Key/Exit
2	>/ Volume up (option)
3	</ Volume down (option)
4	MENU/ENTER
5	LED
6	POWER

---

## Back Bezel

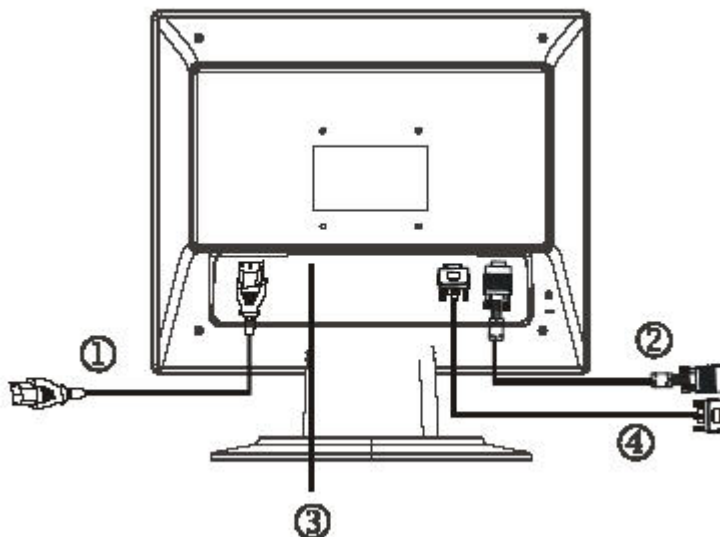

Item	Description
1	AC POWER CORD
2	Signal Cable
3	Audio Cable (Only for speaker)
4	DVI Cable (Only Dual-Input Mode)

# Chapter 2

## Operating Instructions

Press the power button to turn the monitor on or off. The other control buttons are located at front panel of the monitor. By changing these settings, the picture can be adjusted to your personal preferences.

- The power cord should be connected.
- Connect the video cable from the monitor to the video card.
- Press the power button to turn on the monitor position. The power indicator will light up.

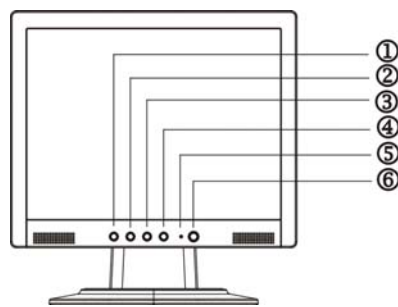

External Control Button

## EXTERNAL CONTROLS

1. Auto Adjust Key/Exit	4. MENU/ENTER
2. >/ Volume up (option)	5. LED
3. </ Volume down (option)	6. Power Key

## FRONT PANEL CONTROLS

- **Power Button:**

Press this button to turn the monitor ON or OFF.

- **MENU / ENTER:**

Activate OSD menu when OSD is OFF or activate/de-activate adjustment function when OSD is ON or Exit OSD menu when in Volume Adjust OSD status.

- **</ Volume down:**

Activates the volume control when the OSD is OFF or navigate through adjustment icons when OSD is ON or adjust a function when function is activated.

---

- **>/ Volume up:**

Activates the volume control when the OSD is OFF or navigate through adjustment icons when OSD is ON or adjust a function when function is activated.

- **Auto Adjust button / Exit:**

1. When OSD menu is in active status, this button will act as EXIT-KEY

(Exit OSD menu).

2. When OSD menu is in off status, press this button for 2 seconds to activate the Auto Adjustment function.

The Auto Adjustment function is used to set the H-Pos, V-Pos, Clock and Focus.

- **Power Indicator:**

Green—Power On mode.

Orange— Power Off mode.

## NOTES

- Do not install the monitor in a location near heat sources such as radiators or air ducts, or in a place subject to direct sunlight, or excessive dust or mechanical vibration or shock.
- Save the original shipping carton and packing materials, as they will come in handy if you ever have to ship your monitor.
- For maximum protection, repackage your monitor as it was originally packed at the factory.
- To keep the monitor looking new, periodically clean it with a soft cloth. Stubborn stains may be removed with a cloth lightly dampened with a mild detergent solution. Never use strong solvents such as thinner, benzene, or abrasive cleaners, since these will damage the cabinet. As a safety precaution, always unplug the monitor before cleaning it.

## OSD Menu

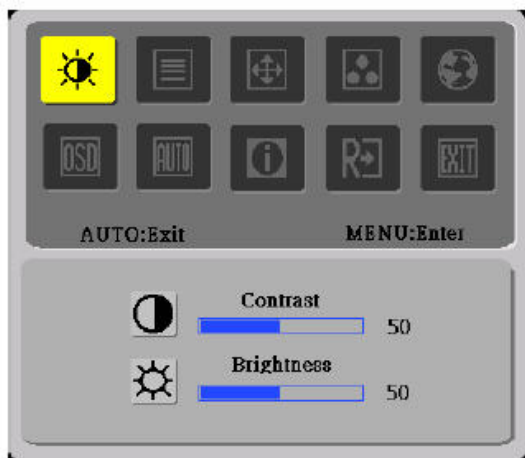

I. Analog-Only Model



II. Dual-Input Model, Analog Signal Input

























III. Dual-Input Model, Digital Signal Input

## How to adjust a setting:

1. Press the MENU-button to activate the OSD window. See figure 4.
2. Press < or > to select the desired function. See figure 4.
3. Press the MENU-button to select the function that you want to adjust.
4. Press < or > to change the settings of the current function.
5. To exit and save, select the exit function. If you want to adjust any other function, repeat steps 2-4.

## The description for control function:

Main Menu Icon	Sub Menu Icon	Sub Menu Item	Description
		Contrast	Contrast from Digital-register.
		Brightness	Backlight Adjustment
		Focus	Adjust Picture Phase to reduce Horizontal-Line noise
		Clock	Adjust picture Clock to reduce Vertical-Line noise.
		H. Position	Adjust the horizontal position of the picture.
		V. Position	Adjust the vertical position of the picture.
	N/A	Warm	Recall Warm Color Temperature from EEPROM.
	N/A	Cool	Recall Cool Color Temperature from EEPROM.
		User / Red	Red Gain from Digital-register.
		User / Green	Green Gain Digital-register.
		User / Blue	Blue Gain from Digital-register.
	N/A	English	Set OSD display language to English.
	N/A	繁體中文	Set OSD display language to Traditional Chinese.
	N/A	Deutsch	Set OSD display language to German.
	N/A	简体中文	Set OSD display language to Simplified Chinese.
	N/A	日本語	Set OSD display language to Japanese.
		H. Position	Adjust the horizontal position of the OSD.
		V. Position	Adjust the vertical position of the OSD.
		OSD Timeout	Adjust the OSD timeout.

Main Menu Icon	Sub Menu Icon	Sub Menu Item	Description
 (Only Analog-Input Model)	N/A	Auto Config	Auto Adjust the H/V Position, Focus and Clock of picture.
 (Only Dual-Input Mode)	N/A	Analog	Select input signal from analog (D-Sub)
	N/A	Digital	Select input signal from digital (DVI)
	N/A	Information	Show the resolution, H/V frequency and input port of current input timing.
	N/A	Reset	Clear each old status of Auto-configuration and set the color temperature to Cool.
	N/A	Exit	Exit OSD

## Hot-Key Menu

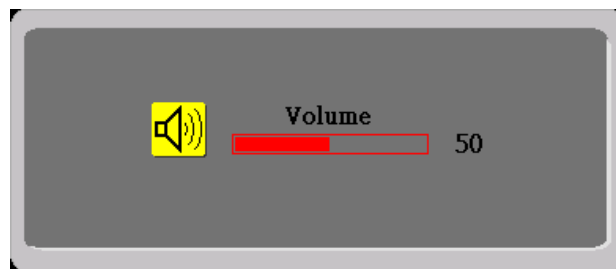

### The description for Hot-Key function:

Item	Operation	Icon	Description
Volume	When the OSD is closed, press Left or Right button will be Volume Hot-Key Function		Volume of Audio adjustment. The Audio will be Mute when volume=0.



---

## OSD Message



### The description for OSD Message:

Item	Description
<b>Auto Config Please Wait</b>	1.) When Analog signal input, if User Press Hot-Key "Auto", will show this message, and the monitor do the auto config function. 2.) When Digital signal input, without this OSD Message.
<b>Input Not Supported</b>	When the Hsync Frequency, Vsync Frequency or Resolution is out of the monitor support range, will show this message. This message will be flying.
<b>Cable Not Connected</b>	1.) Analog-Only Model: When the video cable is not connected, will show this message. This message will be flying. 2.) Dual-Input Model: Dual-Input Model without this OSD Message.
<b>No Signal</b>	1.) Analog-Only Model: When the video cable is connected, but there is no active signal input, will show this message, then enter power saving. 2.) Dual-Input Model: When the video cable is not connected, or the video cable is connected but there is no active signal input, will show this message, then enter power saving.

## LOGO

When the monitor is power on, the LOGO will be showed in the center, and disappear slowly.















# Chapter 3





## Machine Disassembly

This chapter contains step-by-step procedures on how to assemble the monitor for maintenance and troubleshooting.

- NOTE:**
1. The screws for the different components vary in size. During the disassembly process, group the screws with the corresponding components to avoid mismatch when putting back the components.
  2. Note: The monitor surface is susceptible to scratching! Therefore, lay the monitor on a soft surface when mounting or removing the base.
  3. Wear gloves

Picture	Description
	<p>To stick the insulated film on the mainframe and the shield</p>
	
 <p style="text-align: right;">1</p>	<p>Make preparation before putting the main board:</p> <ol style="list-style-type: none"> <li>1. insert the wiring harness</li> <li>2. stick the soft cushion</li> </ol>
 <p style="text-align: right;">2</p>	
	<p>To put the bezel on panel</p>
	<p>To fix the main frame and panel with the screws</p>

Picture	Description
	<p>To put inverter board, and connect related interfaces</p>
	<p>To fix the board with screws</p>
	<p>To fix the wires with adhesive tape</p>
	<p>Connect Inverter board with Audio board</p>
	<p>To fix Audio board with screws</p>
	<p>To connect main board with Audio board</p>
	<p>To connect all other interfaces</p>

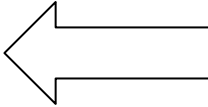
	
	
	
	<p>To fix the main board with screws</p>
	<p>After having fix the board, cover the shield on them</p> <p>STRENGTH: </p>
<p>In the end, cover the back bezel and connect above part with the chassis</p>	

- Warning: 1. In order to prevent the static disturbance, wear resisting static ring  
2. No watch

## Trouble shooting

This chapter provides troubleshooting information for the AL1715:

Defect Mode	Failure Analysis	Repair	Testing
-------------	------------------	--------	---------

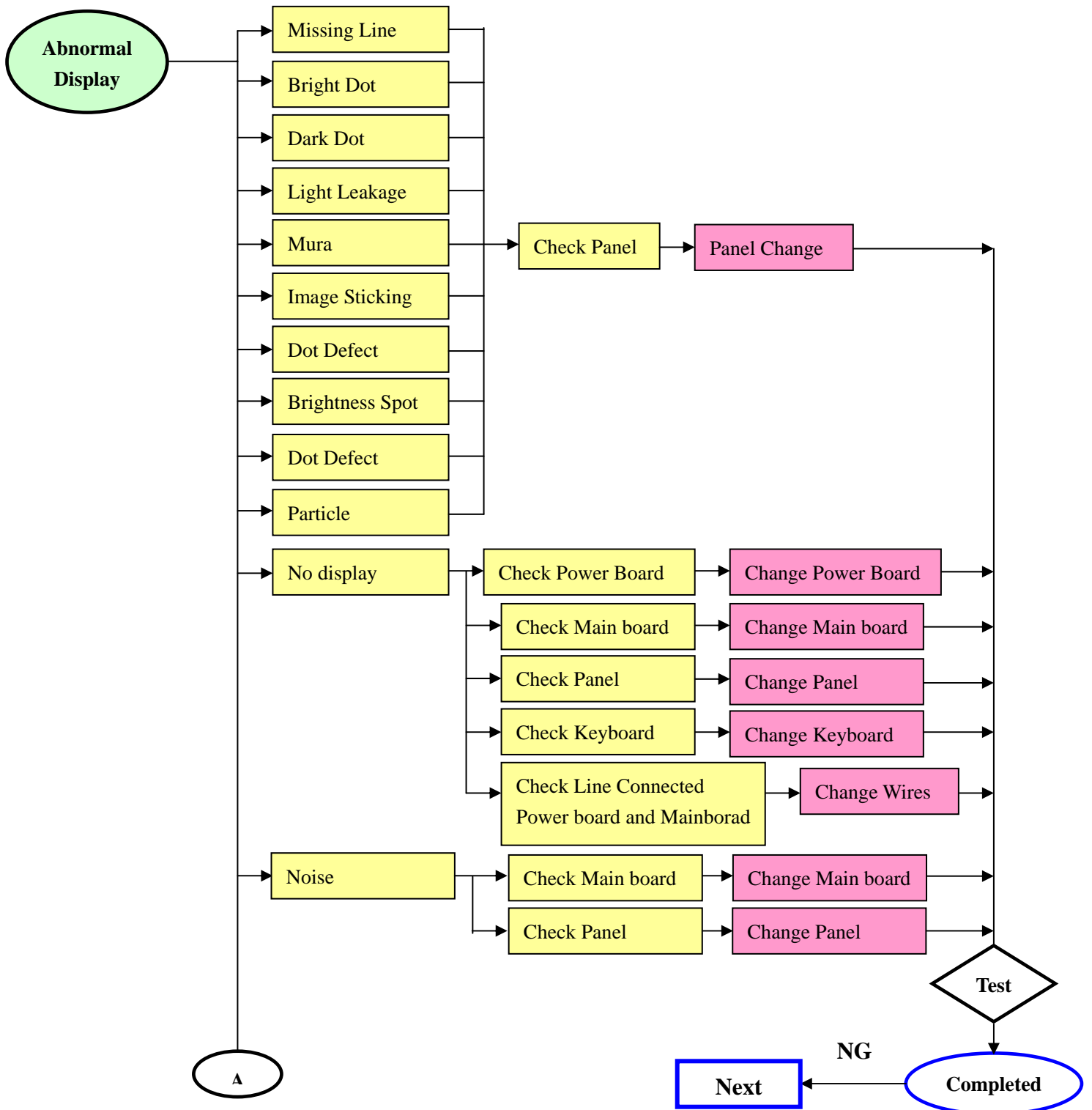

Defect Mode	Failure Analysis	Repair	Testing
-------------	------------------	--------	---------

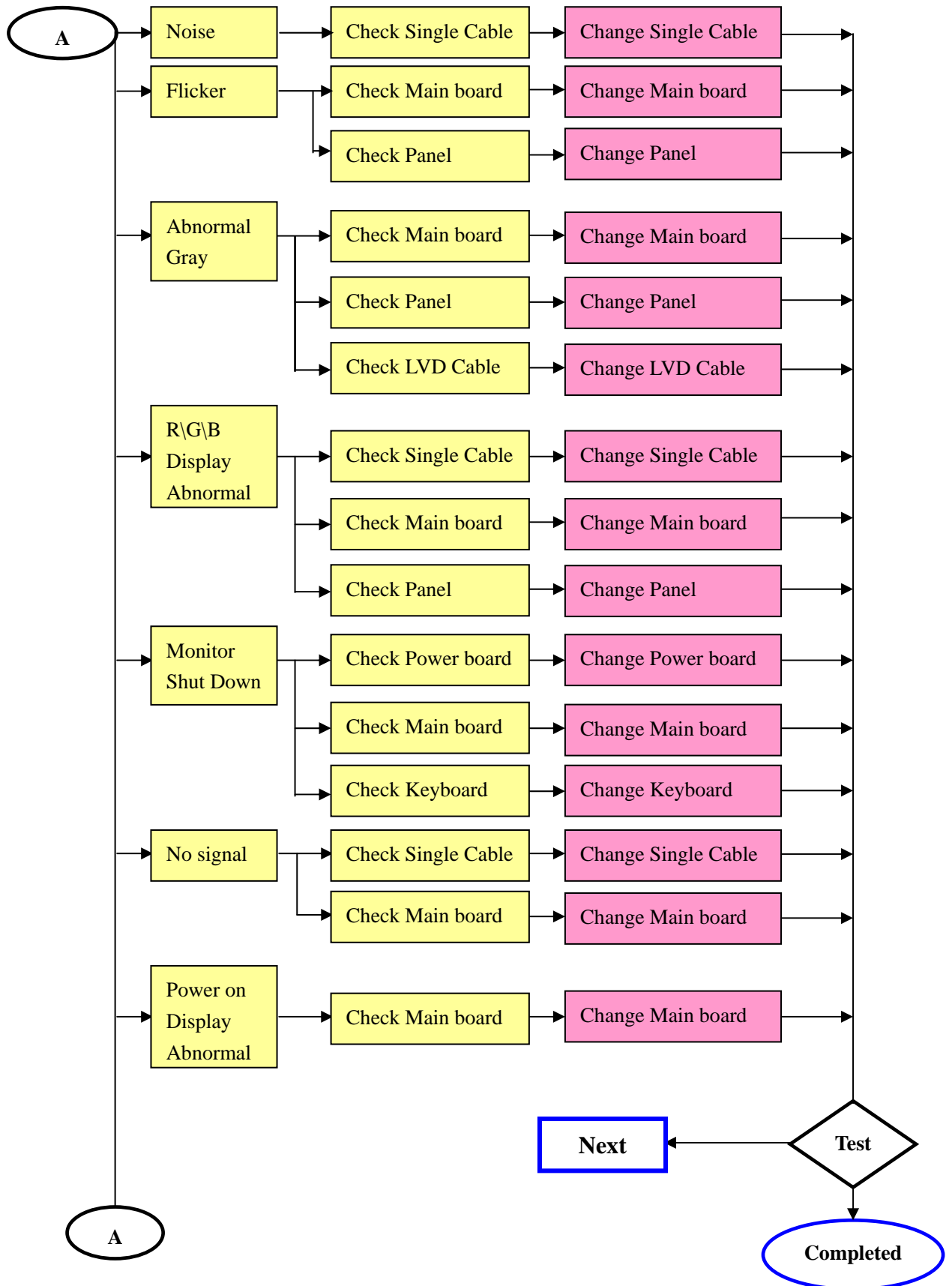

Defect Mode	Failure Analysis	Repair	Testing
-------------	------------------	--------	---------

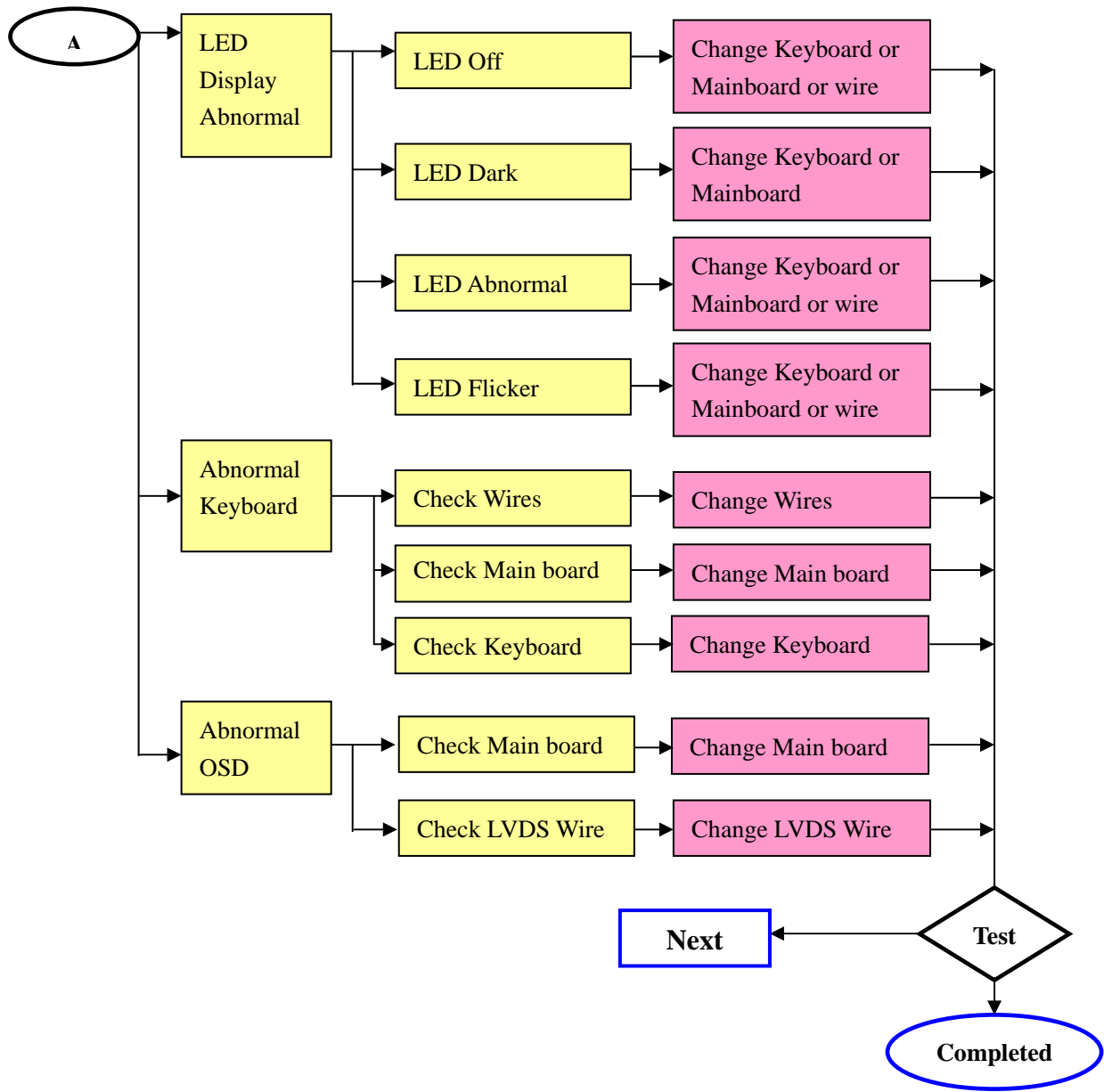

## Connector Information

The following figure shows the connector locations on the monitor board:

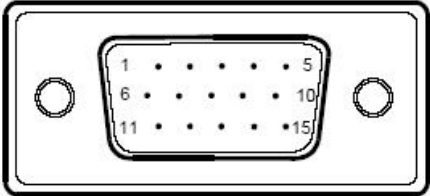

15 - Pin Color Display Signal Cable

PIN NO.	DESCRIPTION	PIN NO.	DESCRIPTION
1.	Red	9.	+5V
2.	Green	10.	Logic Ground
3.	Blue	11.	Monitor Ground
4.	Monitor Ground	12.	DDC-Serial Data
5.	DDC-return	13.	H-Sync
6.	R-Ground	14.	V-Sync
7.	G-Ground	15.	DDC-Serial Clock
8.	B-Ground		

(Dual-Input Model)

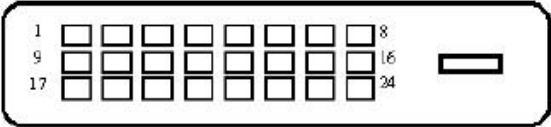





24 - Pin Color Display Signal Cable







Pin	Meaning	Pin	Meaning
1.	TMDS Data2-	13.	TMDS Data3+
2.	TMDS Data2+	14.	+5V Power
3.	TMDS Data 2/4 Shield	15.	GND(return for +5V hsync.vsync)
4.	TMDS Data4-	16.	Hot Plug Detect
5.	TMDS Data4+	17.	TMDS Data0-
6.	DDC Clock	18.	TMDS Data0+
7.	DDC Data	19.	TMDS Data 0/5 Shield
8.	Analogue Vertical Sync	20.	TMDS Data5-
9.	TMDS Data1-	21.	TMDS Data5+
10.	TMDS Data1+	22.	TMDS Clock Shield
11.	TMDS Data 1/3 Shield	23.	TMDS Clock+
12.	TMDS Data3-	24.	DDC TMDS Clock-











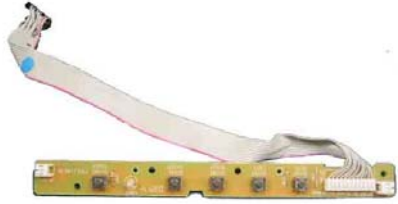











Note: above picture show the description of the following component

No.	Picture	Description
1	 A rectangular, light-colored plastic frame with a central rectangular cutout and a small speaker grille at the bottom center.	Front Bezel
2	 A dark grey, rectangular metal frame with various mounting points, a central rectangular cutout, and a small rectangular slot at the bottom center.	Main Frame
3	 A dark grey, rectangular plastic cover with a central rectangular cutout and a small rectangular slot at the bottom center.	Back cover
4	 A dark grey, rectangular metal panel with various mounting points, a central rectangular cutout, and a small rectangular slot at the bottom center.	Panel

5		Shield
No.	Picture	Description
6		Hinge cover
7		Stand base
8		Foot sticker
9		Inverter board
10		Mylar

11		Function board
12		Speaker (option)
No.	Picture	Description
13		Main board
14		Audio Board (option)
15		Signal cable
16		Audio cable (option)
17		Power code
18		Inverter board cable
19		LVDS cable

		
20		Sponge
21		Mainframe screws
<b>No.</b>	<b>Picture</b>	<b>Description</b>
22		Rear panel screws
23		Ground rush
24		Hinge cover screws
25		Function board screws
26		Main shield screws
27		D-sub screws

## Schematic Diagram

### INPUT

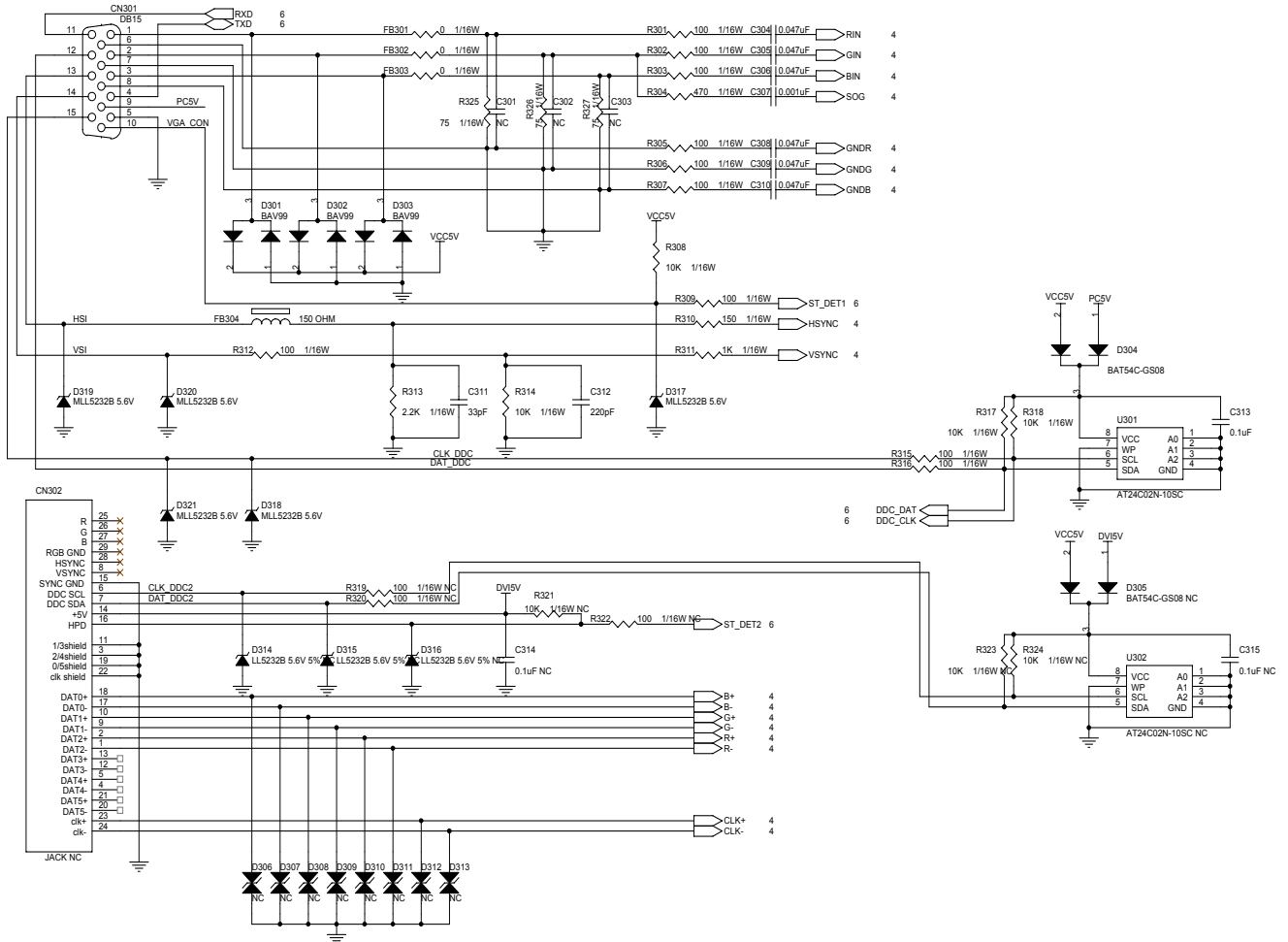

# SCALER TSU16AK

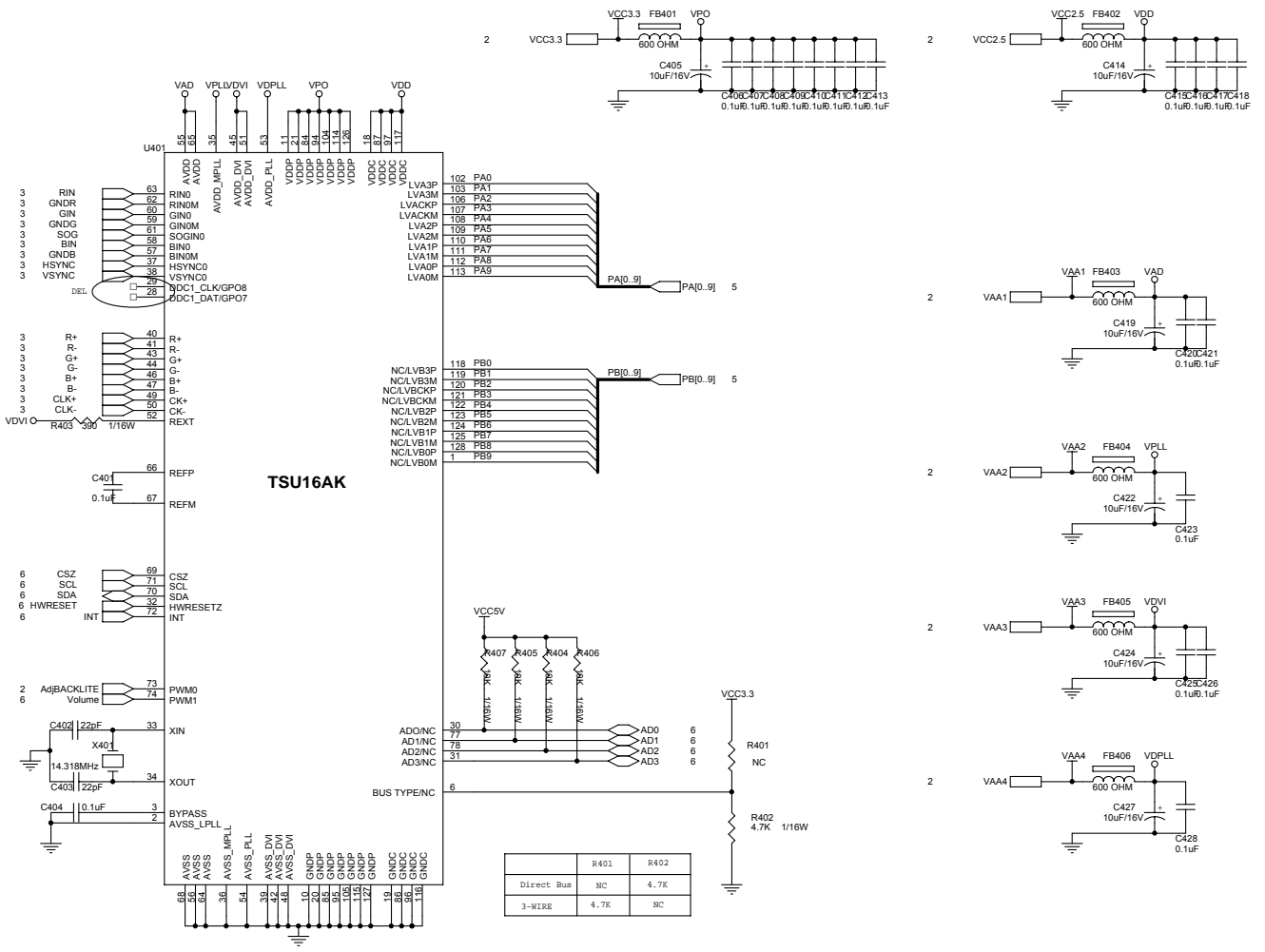

# PANEL INTERFACE

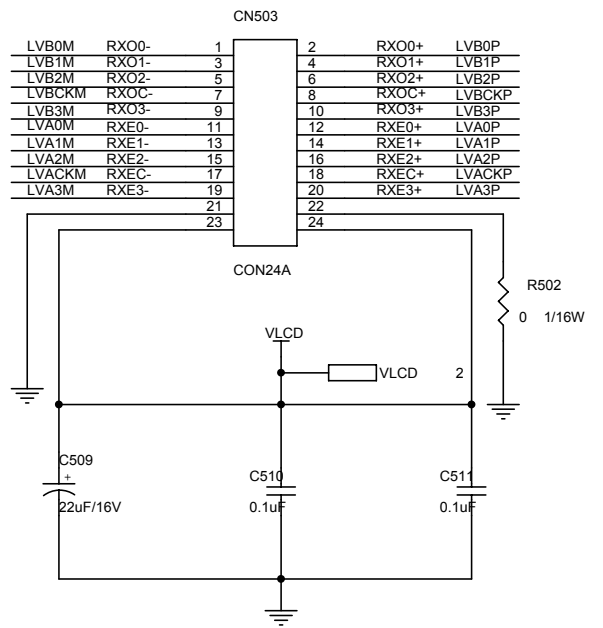
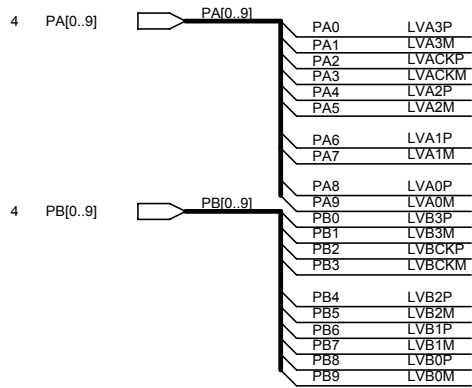



# MCU

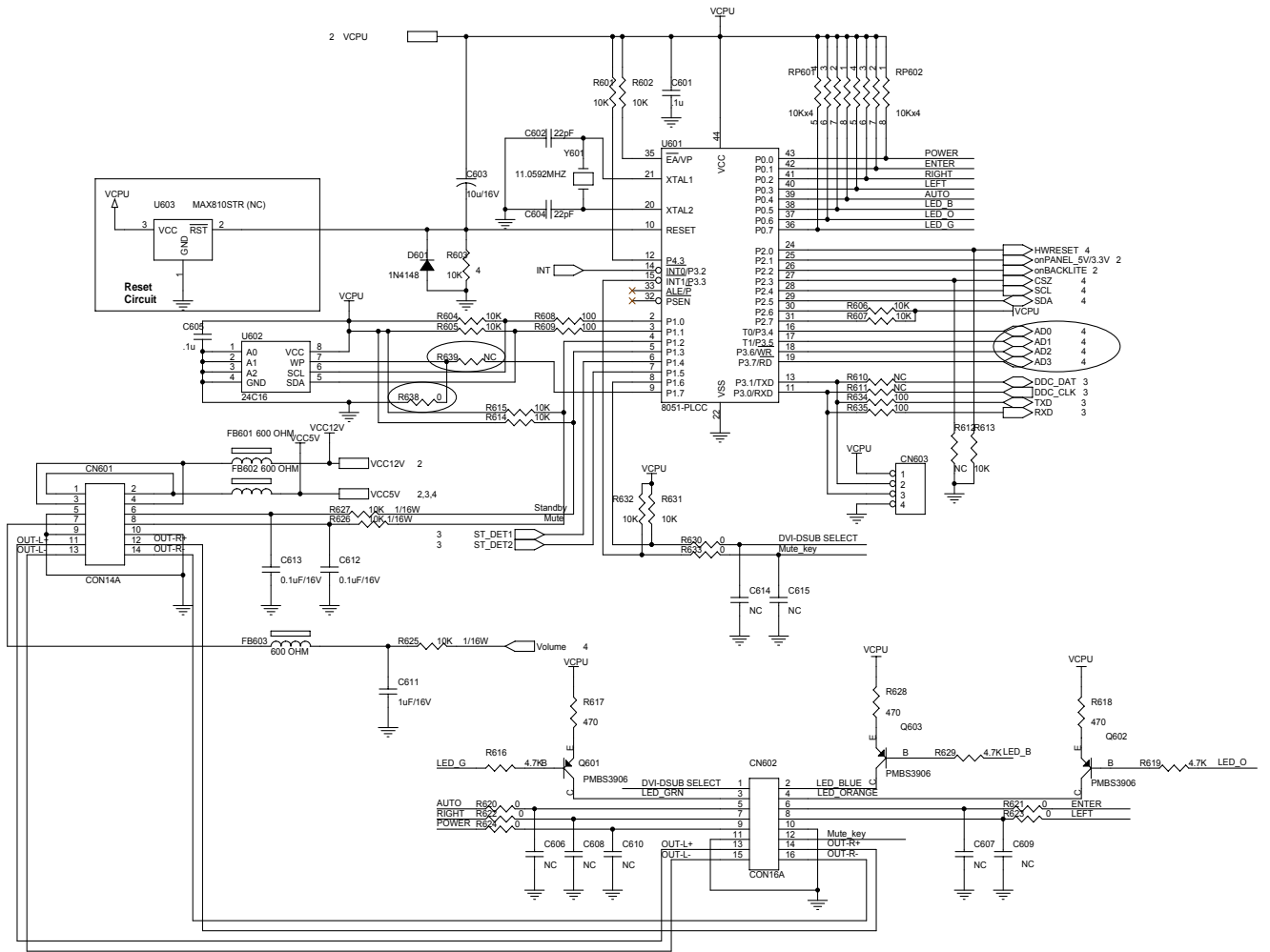

## Online Support Information

This section describes online technical support services available to help you repair your Acer Systems. If you are a distributor, dealer, ASP or TPM, please refer your technical queries to your local Acer branch office. Acer Branch Offices and Regional Business Units may access our website. However some sources will require a user i.d. and password. These can be obtained directly from Acer CSD Taiwan. Acer's Website offers you convenient and valuable support resources whenever you need them. In the Technical Information section you can download information on all of Acer's Notebook, Desktop Server models including:

- Service guides
- User's manuals
- Training materials
- Bios updates
- Spare parts lists
- TABs (Technical Announcement Bulletin)

For these purposes, we have included an Acrobat File to facilitate the problem-free downloading of technical material.

Also contained on this website are:

- Detailed information on Acer's International Traveler's Warranty (ITW)
- Returned material authorization procedures

An overview of all the support services we offer, accompanied by a list of telephone, fax contacts for all your technical queries.

We are always looking for ways to optimize and improve our services, so if you have any suggestions comments, please do not hesitate to communicate these to us.