

# CATEYE STRADA DIGITAL WIRELESS



CYCLOCOMPUTER  
CC-RD430DW

- ⚡ **Before using the computer, please thoroughly read this manual and keep it for future reference. Please visit our website, where detailed instructions with movies are available and the instruction manual can be downloaded.**

**The sensor ID was synchronized with this unit before shipment. It is not necessary to synchronize the sensor ID.**

## Warning / Caution

- Pace maker users should never use this device.
- Do not concentrate on the computer while riding. Ride safely!
- Install the magnet, sensor, and bracket securely. Check these periodically.
- If a child swallows a battery, consult a doctor immediately.
- Do not leave the computer in direct sunlight for a long period of time.
- Do not disassemble the computer.
- Do not drop the computer to avoid malfunction or damage.
- When using the computer installed on the bracket, change the **MODE** by pressing on the three dots below the screen. Pressing hard on other areas can result in malfunction or damage to the computer.
- Be sure to tighten the dial of the FlexTight™ bracket by hand. Tightening it strongly using a tool, etc. may damage the screw thread.
- Stop using the unit if you have skin irritation with the HR strap or electrode pad.
- Do not twist or pull strongly the HR strap.
- The HR strap may deteriorate due to long-term use. Replace the HR strap if it has frequent measurement errors.
- When cleaning the computer, bracket and sensor, do not use thinners, benzene, or alcohol.
- Dispose of used batteries according to local regulations.
- LCD screen may be distorted when viewed through polarized sunglasses lenses.

## 2.4GHz digital wireless system

Each sensor adopts the 2.4GHz digital wireless technology, which is used for wireless LAN, etc. This technology practically eliminates interference from any external noise and cross-talk with other wireless computer users during measurement, and enables it to record and store highly reliable data. However, it suffers interference in the following places and/or environments, which may result in an incorrect measurement.

- \* Careful attention is required especially while checking the sensor ID.
- TV, PC, radios, motors/engines, or in cars and trains.
- Railroad crossings and near railway tracks, around television transmitting stations and radar bases.
- Other wireless computers or digitally controlled lights.
- In the Wi-Fi environment.

## Automatic recognition of the speed sensor ID

The speed sensor has its own ID, and the computer measures in synchronization with the ID.

Two speed-sensor IDs can be registered to one computer, which can automatically identify two speed sensors once their IDs are registered in advance.

As a tire circumference is set to the speed sensor ID, wheel selection by manual operation is no longer required, which was necessary with conventional units.

\* The speed sensor currently recognized is indicated with a sensor icon (1 or 2) on the screen.

### Procedure of automatic recognition

When the computer changes to the power saving screen, and then returns to the measurement screen, automatic recognition of the speed sensor ID is performed in the following procedure.

- 1 The computer searches the speed sensor ID signal, which had been synchronized immediately before.
- 2 Once the sensor signal is received, the sensor icon for the speed sensor lights up, and the computer starts the measurement. When the speed sensor ID signal which had been synchronized immediately before, cannot be received another sensor signal is searched.
- 3 When the computer receives another sensor signal, the sensor icon for the other sensor lights up on the screen, and starts the measurement. When another speed sensor ID signal cannot be received, the original sensor signal is searched again.

The computer repeats synchronization through the procedure described above even if it fails in synchronization for some reason, such as communication failure; in such cases however, it takes time for recognition.

\* When the computer does not receive any signal from the sensor for 10 minutes, it will change to the power-saving screen. When such a condition lasts another 1 hour, it will get into the sleep state.

### Switching the ID by manual operation

The speed sensor ID can be forced to change manually, according to the menu screen "Setting the tire circumference". Use this operation in the following cases.

- When the computer cannot recognize the intended sensor signal, since the 2 registered speed sensors are nearby and both are sending a sensor signal.
- When you want to switch the speed sensor ID immediately.
- \* Once you switch the speed sensor ID by manual operation, the computer continues to search only the speed sensor ID you switched when returning to the measurement screen. When the computer cannot receive any sensor signal in 10 minutes, the power-saving mode is activated, and the computer changes to the power saving screen. The computer searches through the procedure of automatic recognition when it returns to the measurement screen.

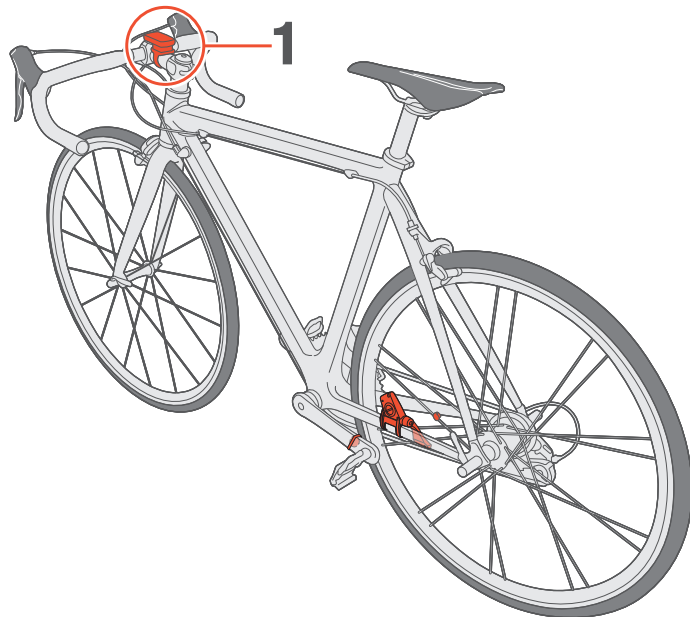

## 1 Attach the bracket to the stem or handlebar

The FlexTight™ bracket can be attached to either the stem or the handlebar, depending on how the bracket fits into the bracket band.

**Caution** Be sure to tighten the dial of the FlexTight™ bracket by hand.

Tightening it strongly using a tool, etc. may damage the screw thread.

When attaching the FlexTight™ bracket to the stem :

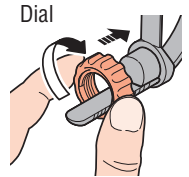
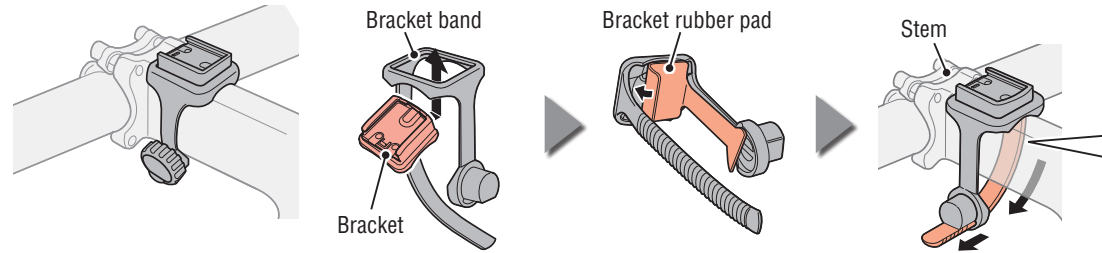

When attaching the FlexTight™ bracket to the handlebar :

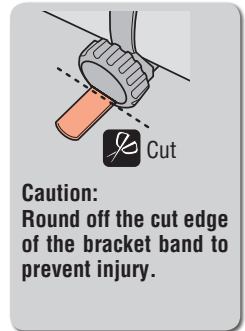
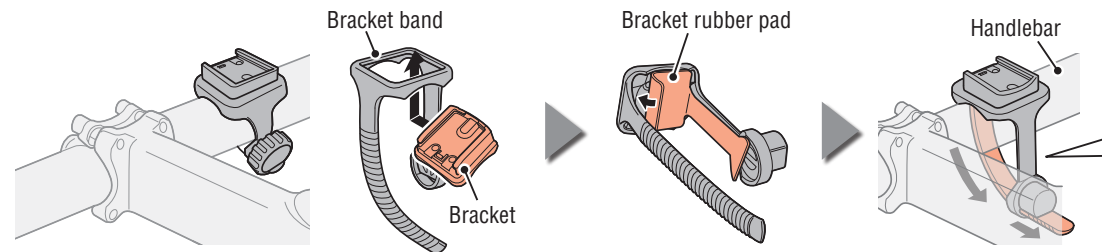

\* To mount the bracket to an aero-shaped handlebar or larger stem, use the optional nylon ties bracket.

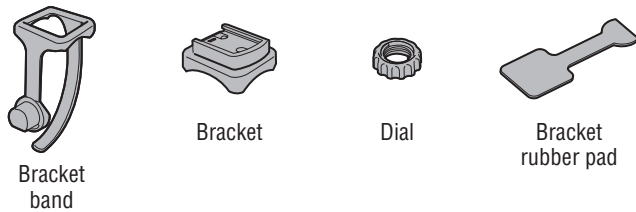

## Remove/Install the computer

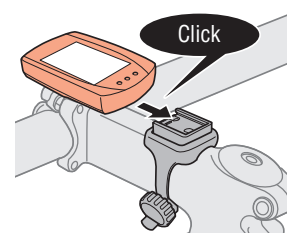

While supporting it by hand,

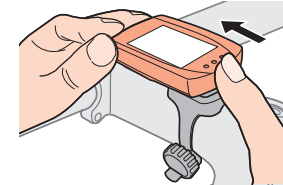

Push it out as if lifting the front up

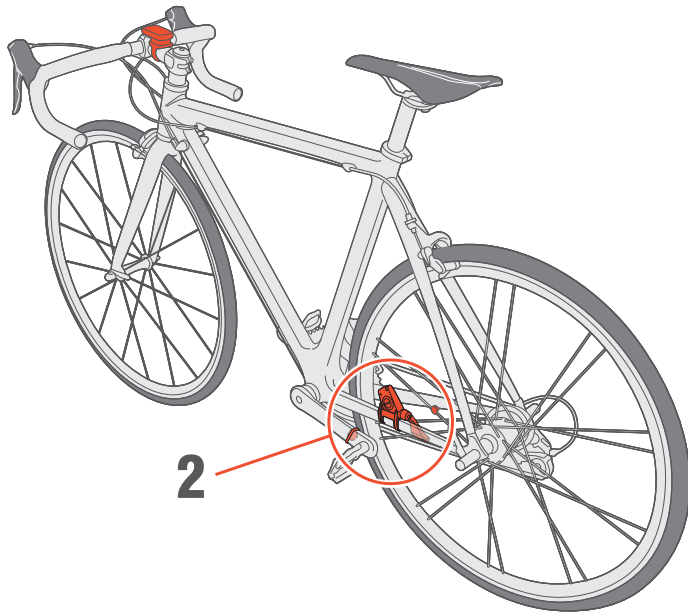

## 2 Mount the speed sensor and magnet

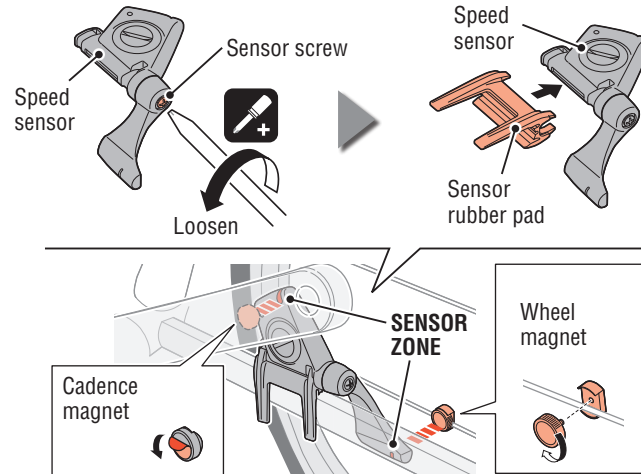

\* The wheel magnet may be installed anywhere on the spoke if the above installation conditions are satisfied.

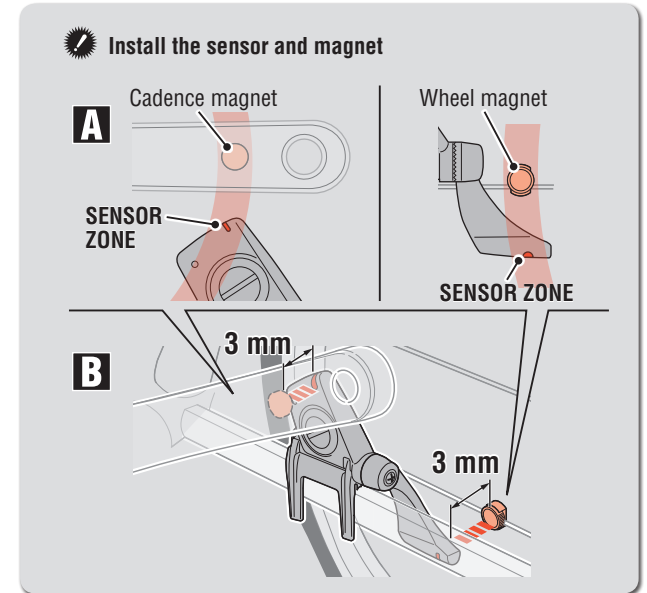

### Adjust the position of the cadence magnet

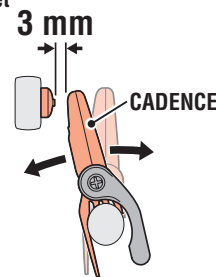
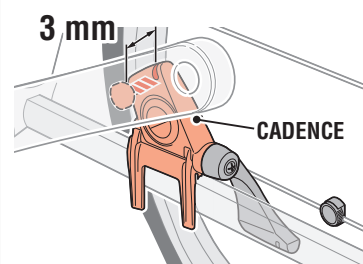

### Adjust the position of the wheel magnet

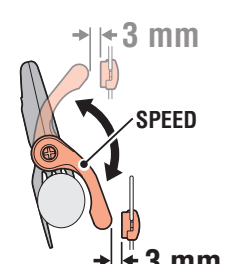
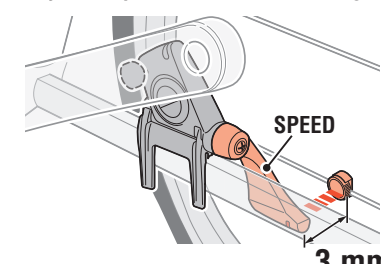

\* When the sensor is not positioned appropriately in respect to the two magnets ( A B ), move the sensor back and forth so that it is positioned properly.

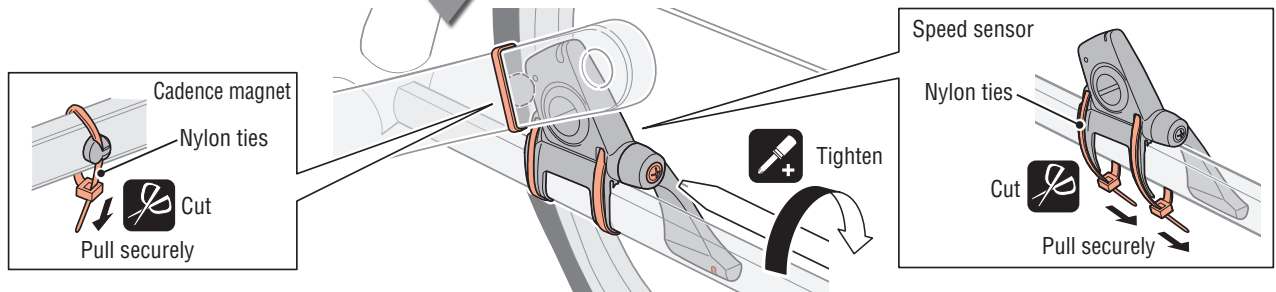
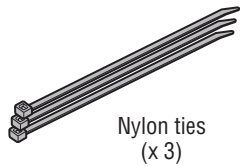
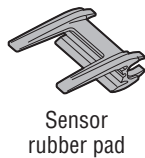
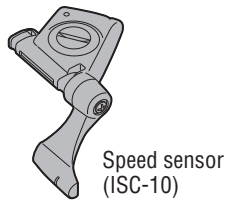

## Before wearing the heart rate sensor

**Warning: Pace maker users should never use this device.**

- Stop using the unit if you have skin irritation with the HR strap or electrode pad.
- Do not twist or pull strongly the HR strap.
- The HR strap may deteriorate due to long-term use. Replace the HR strap if it has frequent measurement errors.

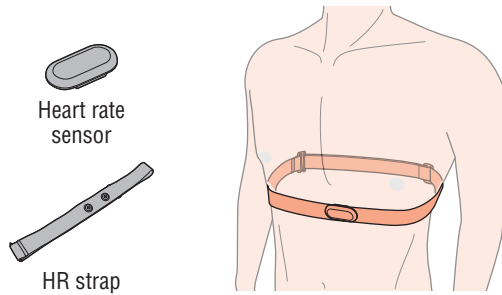

## Wearing the heart rate sensor

- \* Adjust the HR strap length to fit your chest size (underbust). Fastening the strap too tightly may cause discomfort.
- \* Ensure that the electrode pad is in direct contact with the body.
- \* Wearing the heart rate sensor when your skin is dry or on top of your undershirt may produce measurement errors. To avoid errors, moisten the electrode pad.
- \* The heart rate sensor consumes power when worn. Remove the heart rate sensor whenever measurement is not performed.

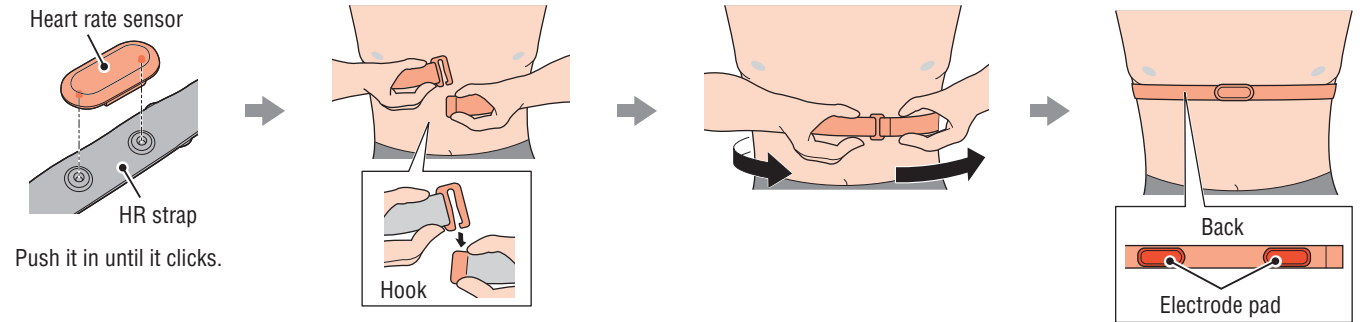

Perform the following formatting operation, when you use the unit for the first time or restore the unit to the condition before shipment.

## 1 Format (initialize)

Press the **MENU** button on the back of the computer and the **AC** button simultaneously.

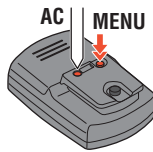

## 2 Select the speed unit

Select "km/h" or "mph".

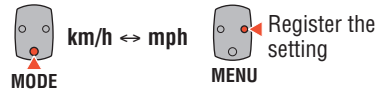

## 3 Enter the tire circumference

Enter the sensor-installed tire circumference in mm.  
\* Use "Tire circumference reference table" as a guide.

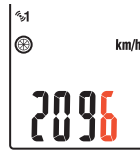
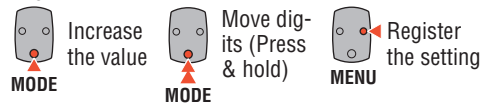

## 4 Set the Clock

Pressing and holding the **MODE** button switches the display to "Displayed time", "Hour", and "Minute" in order.

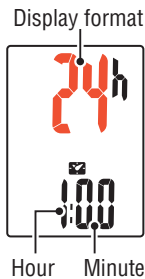
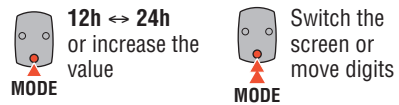

## 5 Press the MENU button to complete setting

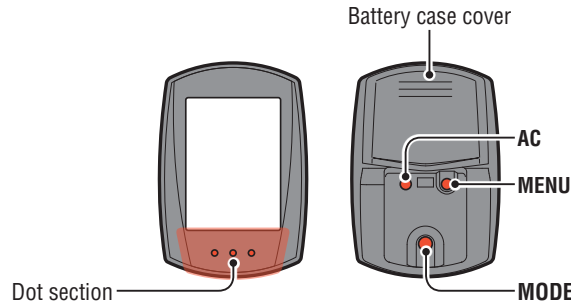
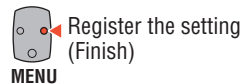

## Operation test

Test the functioning of the speed sensor and the heart rate sensor.

### Speed sensor

After installed, check that the speed is displayed when gently turning the rear wheel, whereas the cadence is displayed when turning the crank. When it is not displayed, check the installation conditions **A** and **B** again (page 3).

Current speed

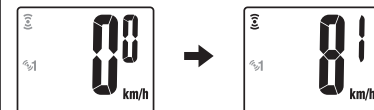

Cadence



### Heart rate sensor

1 Press the **MODE** button to display (heart rate).

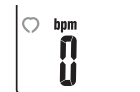

2 It operates normally if the computer displays the heart rate after you wear the heart rate sensor.



\* Even if the heart rate sensor is not worn, a heart rate signal is transmitted by rubbing both electrode pads with your thumb. Use this as a simplified method.

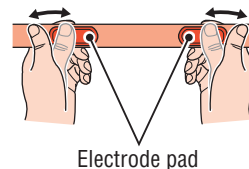

Electrode pad

## Tire circumference

You can find the tire circumference (L) of your tire size in the chart below, or actually measure the tire circumference (L) of your bicycle.

### • How to measure the tire circumference (L)

For the most accurate measurement, do a wheel roll out. With the tires under proper pressure, place the valve stem at the bottom. Mark the spot on the floor and with the rider's weight on the bike, roll exactly one wheel revolution in a straight line (until the valve comes around again to the bottom). Mark where the valve stem is and measure the distance.



\* Measure the tire to which the sensor is installed.

### • Tire circumference reference table

\* Generally, the tire size or ETRTO is indicated on the side of the tire.

ETRTO	Tire size	L (mm)	ETRTO	Tire size	L (mm)
47-203	12x1.75	935	57-559	26x2.125	2070
54-203	12x1.95	940	58-559	26x2.35	2083
40-254	14x1.50	1020	75-559	26x3.00	2170
47-254	14x1.75	1055	28-590	26x1-1/8	1970
40-305	16x1.50	1185	37-590	26x1-3/8	2068
47-305	16x1.75	1195	37-584	26x1-1/2	2100
54-305	16x2.00	1245		650C Tubuler	
28-349	16x1-1/8	1290		26x7/8	1920
37-349	16x1-3/8	1300	20-571	650x20C	1938
32-369	17x1-1/4 (369)	1340	23-571	650x23C	1944
40-355	18x1.50	1340	25-571	650x25C	
47-355	18x1.75	1350		26x1(571)	1952
32-406	20x1.25	1450	40-590	650x38A	2125
35-406	20x1.35	1460	40-584	650x38B	2105
40-406	20x1.50	1490	25-630	27x1(630)	2145
47-406	20x1.75	1515	28-630	27x1-1/8	2155
50-406	20x1.95	1565	32-630	27x1-1/4	2161
28-451	20x1-1/8	1545	37-630	27x1-3/8	2169
37-451	20x1-3/8	1615	18-622	700x18C	2070
37-501	22x1-3/8	1770	19-622	700x19C	2080
40-501	22x1-1/2	1785	20-622	700x20C	2086
47-507	24x1.75	1890	23-622	700x23C	2096
50-507	24x2.00	1925	25-622	700x25C	2105
54-507	24x2.125	1965	28-622	700x28C	2136
25-520	24x1(520)	1753	30-622	700x30C	2146
	24x3/4 Tubuler	1785	32-622	700x32C	2155
28-540	24x1-1/8	1795		700C Tubuler	2130
32-540	24x1-1/4	1905	35-622	700x35C	2168
25-559	26x1(559)	1913	38-622	700x38C	2180
32-559	26x1.25	1950	40-622	700x40C	2200
37-559	26x1.40	2005	42-622	700x42C	2224
40-559	26x1.50	2010	44-622	700x44C	2235
47-559	26x1.75	2023	45-622	700x45C	2242
50-559	26x1.95	2050	47-622	700x47C	2268
54-559	26x2.10	2068	54-622	29x2.1	2288
			60-622	29x2.3	2326

**Speed sensor signal icon**  
It flashes in synch with a speed sensor signal.

**Pace arrow ▲ ▼**  
Indicates if the current speed is faster or slower than the average speed. (▲ Faster, ▼ Slower)

**Sensor icon**  
The speed sensor currently synchronized is displayed.

**HR sensor signal icon ♥**  
It flashes in synch with a heart rate sensor signal.  
\* The position changes according to the heart rate display position.

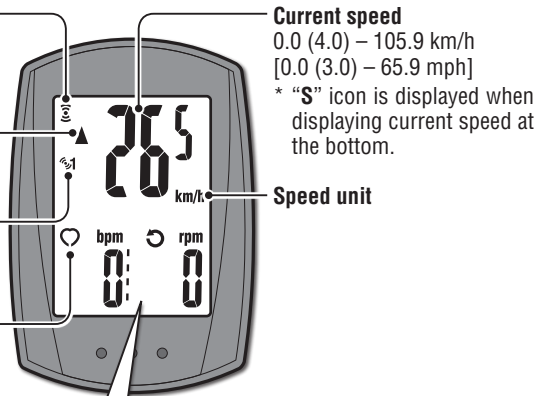

**MODE operation when the computer is mounted on the bracket**

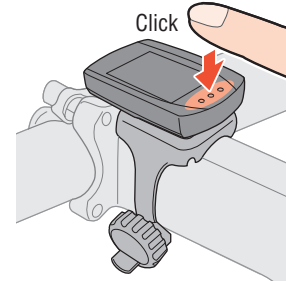

## Starting/Stopping measurement

Measurements start automatically when the bicycle is in motion. During measurement, km/h or mph flashes.

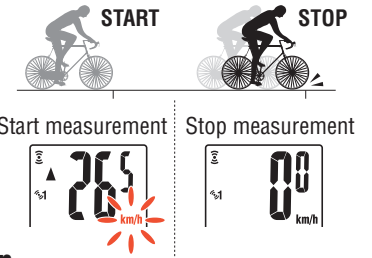

## Upper display selection

The heart rate (♥) or the cadence (♻) can be switched to the upper display to monitor it constantly.

**Setting method** See "Changing the computer settings: Setting the upper display" (Page 7).

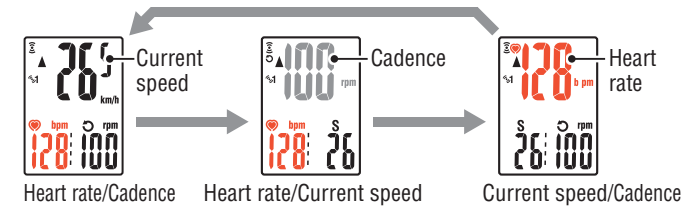

## Resetting data

Pressing and holding the **MODE** button on the measurement screen resets any measurement data, except the total distance (**Odo**) and trip distance-2 (**Dst2**).

\* The total distance (**Odo**) is not reset.

### Resetting separately the trip distance-2

Pressing and holding the **MODE** button with the trip distance-2 (**Dst2**) displayed resets only the data of the trip distance-2.

## Power-saving function

If the computer has not received a signal for 10 minutes, power-saving screen will activate and only the clock will be displayed. With such a screen, pressing the **MODE** button returns to the measurement screen.

\* If another 60 minutes of inactivity elapses in the power-saving screen, only the speed unit is displayed on the screen.

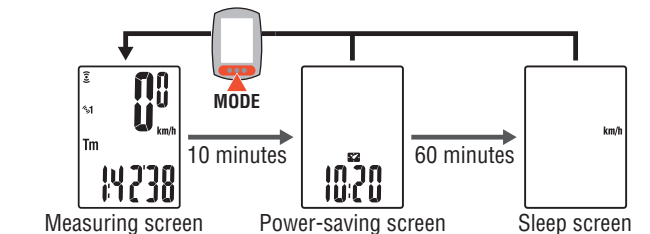

## Switching computer function

Pressing the **MODE** button switches the measurement data at the bottom in the order shown in the following figure.

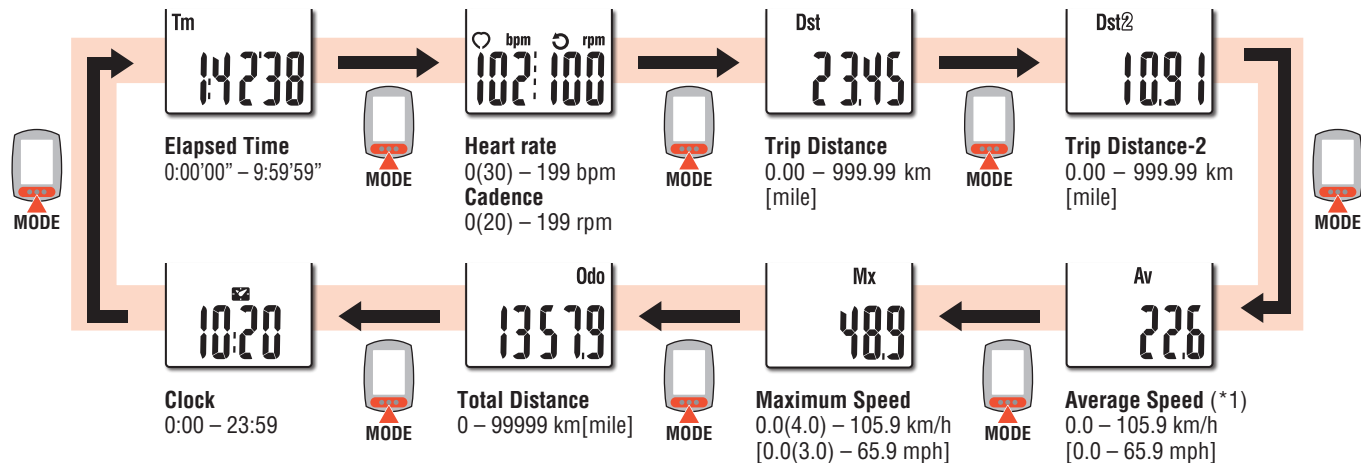

\*1 When **Tm** exceeds about 27 hours, or **Dst** exceeds 999.99 km, .E will appear. Reset the data.

Pressing **MENU** on the measurement screen changes to the menu screen. Various settings can be changed on the menu screen.

\* After changes are made, be sure to register the setting(s) by pressing the **MENU** button.

\* Leaving the menu screen without any operation for 1 minutes returns to the measurement screen, and changes are not saved.

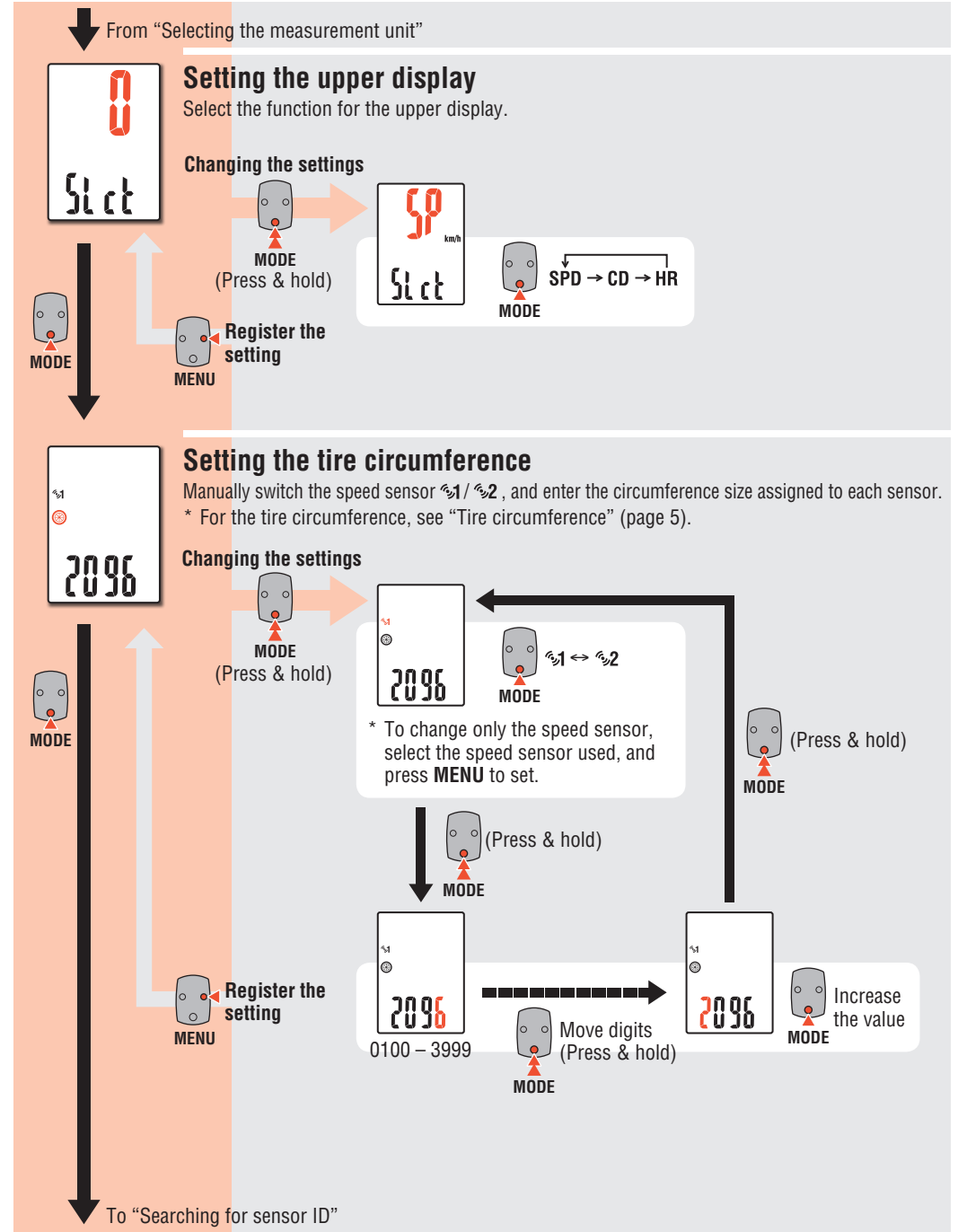
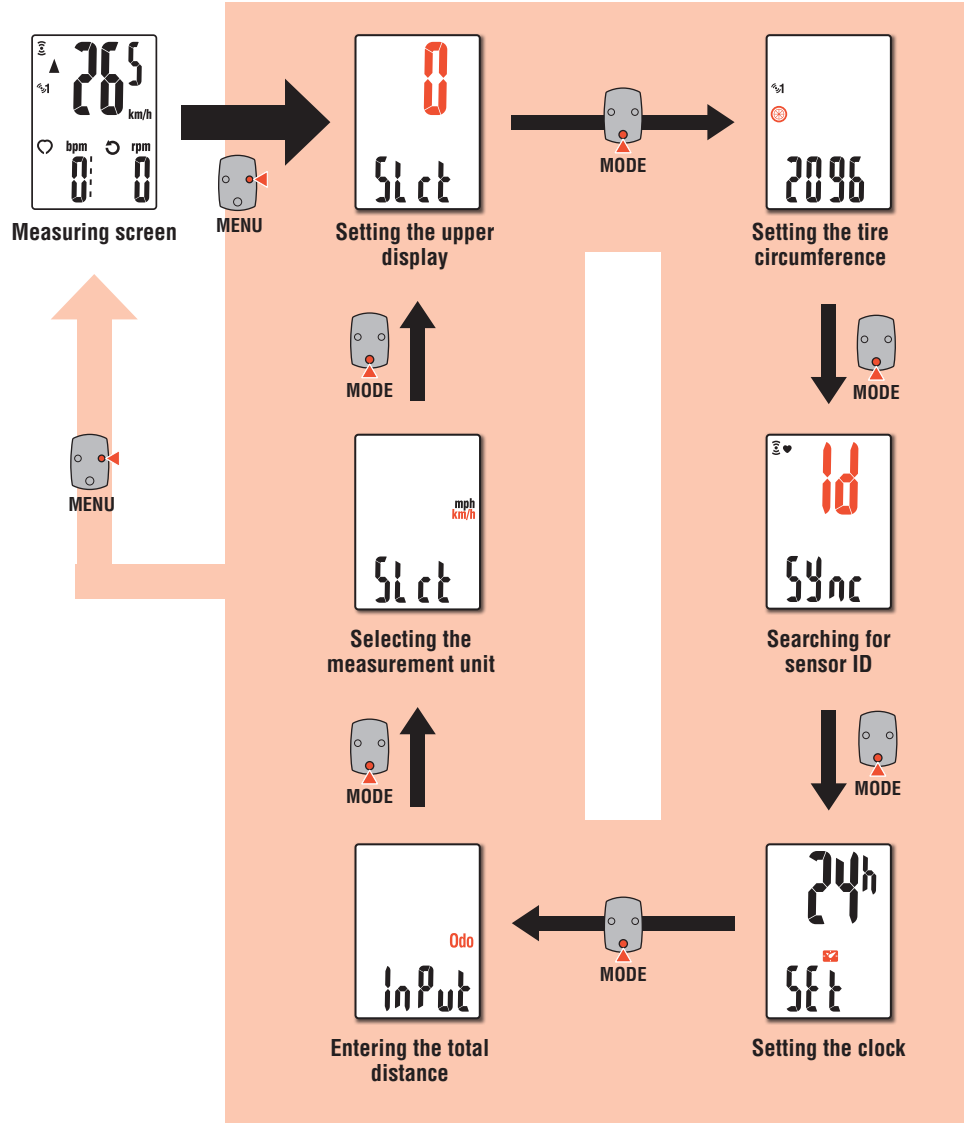

From "Setting the tire circumference"

### Searching for sensor ID

Search the heart rate and speed sensor IDs.  
\* The sensor ID was synchronized with this unit before shipment. Search the sensor ID only when a new sensor is used.

**Changing the settings**

MODE (Press & hold) → SP1

MODE (Press & hold) → SP1 → SP2 → HR

MODE (Press & hold) → SP1

MODE (Press & hold) → SP1

**Register the setting**

MENU → SP1

In case of SP1 and SP2

 → 

In case of HR

 → 

In case of cancellation or 5 minutes of inactivity

 →

MODE (Press & hold) → Error

---

MODE (Press & hold) → 24h

### Setting the clock

Set the clock.

**Changing the settings**

MODE (Press & hold) → 12h ↔ 24h

MODE (Press & hold) → 1:00

Hour: 0 - 23 [1 - 12]

Minute: 00 - 59

MODE (Press & hold) → Increase the value

MODE (Press & hold) → Switch the screen (press & hold)

MODE (Press & hold) → Register the setting

MENU → 24h

To "Entering the total distance"

From "Setting the clock"

### Entering the total distance

Enter the total distance.  
Once you enter any value to the total distance, you can start from the value you entered. Use this function when you renew and/or reset your unit.

**Changing the settings**

MODE (Press & hold) → 01357

MODE (Press & hold) → Increase the value

MODE (Press & hold) → Move digits (press & hold)

00000 - 99999

**Register the setting**

MENU → 01357

---

### Selecting the measurement unit

Select the speed unit (km/h or mph).

**Changing the settings**

MODE (Press & hold) → km/h ↔ mph

MODE (Press & hold) → Register the setting

MENU → km/h ↔ mph

To "Setting the upper display"



## Maintenance

- To clean the computer or accessories, use diluted neutral detergent on a soft cloth, and wipe it off with a dry cloth.
- Since the HR strap directly touches your skin, keep it clean by washing off any dirt after use.

## Replacing the battery

### Computer

#### 1 Replace the lithium battery

When  (battery icon) is turned on, replace the battery. Install a new lithium battery (CR2032) with the (+) side facing upward.

\* Press the top edge of waterproof inner cap to remove it. Install the cap with the "TOP" faced upward.

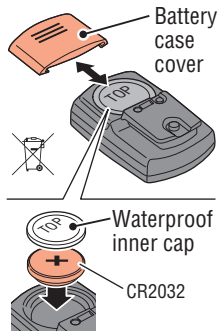
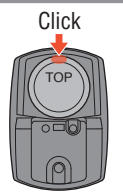

#### 2 Press the AC button on the back of the computer (Restarting operation)

\* When restarting, the speed unit, sensor ID, sensor currently synchronized, tire circumference, upper display setting, and total distance are retained.

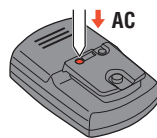

#### 3 Set the Clock

Pressing and holding the **MODE** button switches the display to "Displayed time", "Hour", and "Minute" in order.

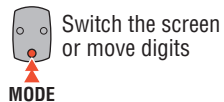
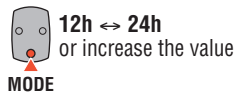

#### 4 Press the MENU button to complete setting

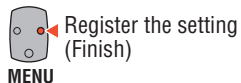

### Heart rate sensor

\* When the heart rate flashes, replace the battery. Insert new lithium batteries (CR2032) with the (+) sign upward, and close the battery cover firmly.

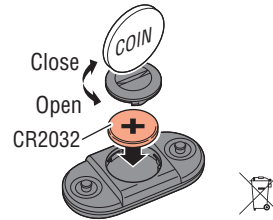

\* Reset the sensor by pressing **RESET** button when you replace the sensor battery.

### Speed sensor

\* When the current speed flashes, replace the speed sensor battery. Insert new lithium batteries (CR2032) with the (+) sign upward, and close the battery cover firmly.

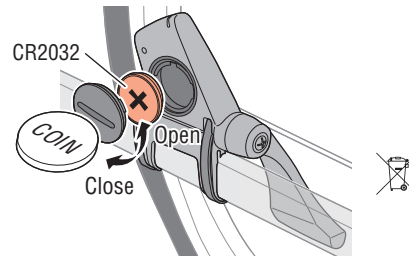

\* After replacement, check the position in respect to the magnet.  
\* Reset the sensor by pressing **RESET** button when you replace the sensor battery.

## Troubleshooting

### The current speed / heart rate cannot be measured.

**SPD / CDC** Check that the clearance between the sensor and magnet is not too large. (Clearance: within 3 mm)  
Check that the magnet passes through the sensor zone correctly.

Adjust the positions of the magnet and sensor.

**HR** Is the heart rate sensor attached securely to your body?

Adjust the electrode pad to have a good contact with the body.

Is the electrode pad overly worn and damaged after long use?

Replace it with a new HR strap.

**Common** Is there any problem in searching the sensor ID?

Search the sensor ID according to the procedure specified in the section "Changing the computer setting / Searching for sensor ID" (Page 8).

Does the computer or sensor indicate when to replace the battery?

Replace with new batteries according to the procedure specified in the section "Replacing the battery."

### Nothing is displayed by pressing the button.

Replace the computer battery according to the procedure specified in the section "Replacing the battery".

### Incorrect data appear.

Restart according to the procedure specified in the section "Replacing the battery / Computer, steps 2 to 4".

### The measurement data is wrong. (The maximum speed is too high, etc.)

Are there any objects emitting electromagnetic waves (railway tracks, transmitting stations for television, Wi-Fi environment, etc.) nearby?

Keep the unit away from any object that may be the cause. Perform the resetting operation in the case of invalid data.

## Specification

Battery / Battery life	Computer :	CR2032 x 1 / Approx. 6 months (When using 1 hour/day)
	Heart rate sensor :	CR2032 x 1 / Approx. 1 year (When worn about 1 hour per day)
	Speed sensor :	CR2032 x 1 / Approx. 1 year (When using 1 hour/day)
* The factory-loaded battery life might be shorter than the above-mentioned specification.		
Controller	1-chip microcomputer (Crystal controlled oscillator)	
Display	Liquid crystal display	
Sensor	No contact magnetic sensor	
Sensor signal transmission and reception	2.4 GHz ISM Band	
Communication range	5 m (It may change depending on the environmental conditions, including weather.)	
Tire circumference range	0100 mm - 3999 mm (Initial value : 2096 mm)	
Working temperature	0 °F - 104 °F (0 °C - 40 °C) (This product will not display appropriately when exceeding the Working Temperature range. Slow response or black LCD at lower or higher temperature may happen respectively.)	
Dimensions/ weight	Computer :	1-53/64" x 1-7/32" x 5/8" (46.5 x 31 x 16 mm) / 0.72 oz (20.3 g)
	Heart rate sensor :	1-7/32" x 2-29/64" x 33/64" (31 x 62.5 x 13.2 mm) / 0.54 oz (15.4 g)
	Speed sensor :	1-55/64" x 2-29/64" x 33/64" (47.4 x 62.4 x 13.1 mm) / 0.74 oz (21 g)

\* The specifications and design are subject to change without notice.

## Limited warranty

### 2-Year: Computer, Heart rate sensor and Speed sensor (Accessories and Battery Consumption excluded)

CatEye cycle computers are warranted to be free of defects from materials and workmanship for a period of two years from original purchase. If the product fails to work due to normal use, CatEye will repair or replace the defect at no charge. Service must be performed by CatEye or an authorized retailer. To return the product, pack it carefully and enclose the warranty certificate (proof of purchase) with instruction for repair. Please write or type your name and address clearly on the warranty certificate. Insurance, handling and transportation charges to CatEye shall be borne by person desiring service. For UK and REPUBLIC OF IRELAND consumers, please return to the place of purchase. This does not affect your statutory rights.

Please register your CatEye product on the website.  
<http://www.cateye.com/en/support/regist/>

### CATEYE CO., LTD.

2-8-25, Kuwazu, Higashi Sumiyoshi-ku, Osaka 546-0041 Japan  
Attn: CATEYE Customer Service Section  
Phone : (06)6719-6863 Fax : (06)6719-6033  
E-mail : support@cateye.co.jp URL : <http://www.cateye.com>

### [For US Customers]

#### CATEYE AMERICA, INC.

2825 Wilderness Place Suite 1200, Boulder CO 80301-5494 USA  
Phone : 303.443.4595 Toll Free : 800.5.CATEYE  
Fax : 303.473.0006 E-mail : [service@cateye.com](mailto:service@cateye.com)

## Spare accessories

### Standard accessories



Parts kit



Speed sensor



Bracket band



Bracket

1699691N



Wheel magnet

1699766



Cadence magnet

1665150



CR2032  
Lithium battery



Heart rate sensor kit



HR strap

### Optional accessories

1602980



Nylon tie bracket

1603685



(SPD-10)  
Speed sensor