

# **AND**

**Digital Blood Pressure Monitor**

**Model UA-767NFC**

***Instruction Manual***

# Contents

Dear Customers .....	2
Preliminary Remarks .....	2
Precautions.....	2
Parts Identification.....	3
Symbols.....	4
Operation Mode.....	6
Using the Monitor .....	7
Installing / Changing the Batteries .....	7
Connecting the Air Hose .....	7
Connecting the AC Adapter.....	7
Notes on the Built-in Clock.....	8
Selecting the Clock Mode .....	8
Adjusting the Clock .....	9
Selecting the Correct Cuff Size .....	10
Applying the Arm Cuff .....	10
How to Take Proper Measurements .....	11
Measurement.....	11
After Measurement .....	11
Measurements .....	12
Normal Measurement.....	12
Measurement with the Desired Systolic Pressure .....	13
Notes for Proper Measurement.....	13
Near Field Communication (NFC) Function .....	14
Memory Data Transmission.....	14
Measurement Data Transmission .....	14
Caution on Using the NFC Function.....	15
What is an Irregular Heartbeat.....	15
Pressure Bar Indicator .....	15
About Blood Pressure.....	15
What is Blood Pressure? .....	15
What is Hypertension and How is it Controlled?.....	16
Why Measure Blood Pressure at Home?.....	16
WHO Blood Pressure Classification .....	16
Blood Pressure Variations.....	16
Troubleshooting .....	17
Maintenance .....	18
Technical Data.....	18

# Dear Customers

Congratulations on purchasing a state-of-the-art A&D blood pressure monitor, one of the most advanced monitors available today. Designed for ease of use and accuracy, this monitor will facilitate your daily blood pressure regimen.

**We recommend that you read through this manual carefully before using the device for the first time.**

## Preliminary Remarks

- This device conforms to the European Directive 93/42 EEC for Medical Products. This is made evident by the **CE**<sub>0366</sub> mark of conformity. (0366: The reference number to the involved notified body)
- The device is designed for use on adults only, not newborns or infants.
- Environment for use  
The device is intended for indoor use.

## Precautions

- Precision components are used in this device. Extreme temperature, humidity, direct sunlight, shock or dust should be avoided.
- Clean the device and cuff with a dry, soft cloth or a cloth dampened with water and a neutral detergent. Never use alcohol, benzene, thinner or other harsh chemicals to clean the device or cuff.
- Avoid tightly folding the cuff or storing the hose tightly twisted for long periods, as such treatment may shorten the life of the components.
- The device and cuff are not water resistant. Prevent rain, sweat and water from soiling the device and cuff.
- Measurements may be affected if the device is used near a television, microwave oven, cellular telephone, X-ray or other devices that emit electromagnetic waves.
- Used equipment, parts and batteries are not treated as ordinary household waste, and must be disposed of according to the applicable local regulations.
- When your arm is squeezed tightly by a cuff, blood collects in the lower arm and finger tips and your arm may become congested.

# Parts Identification

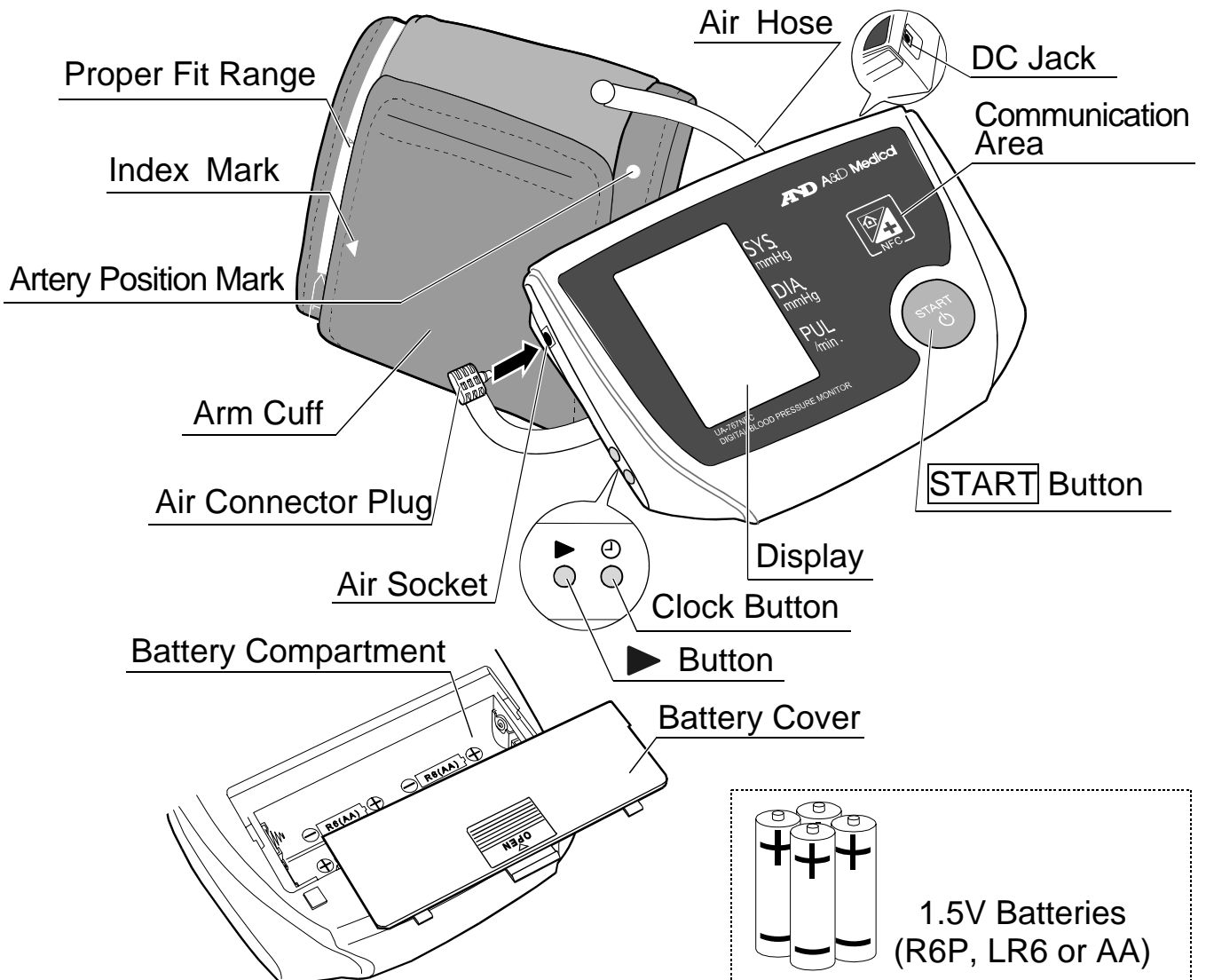



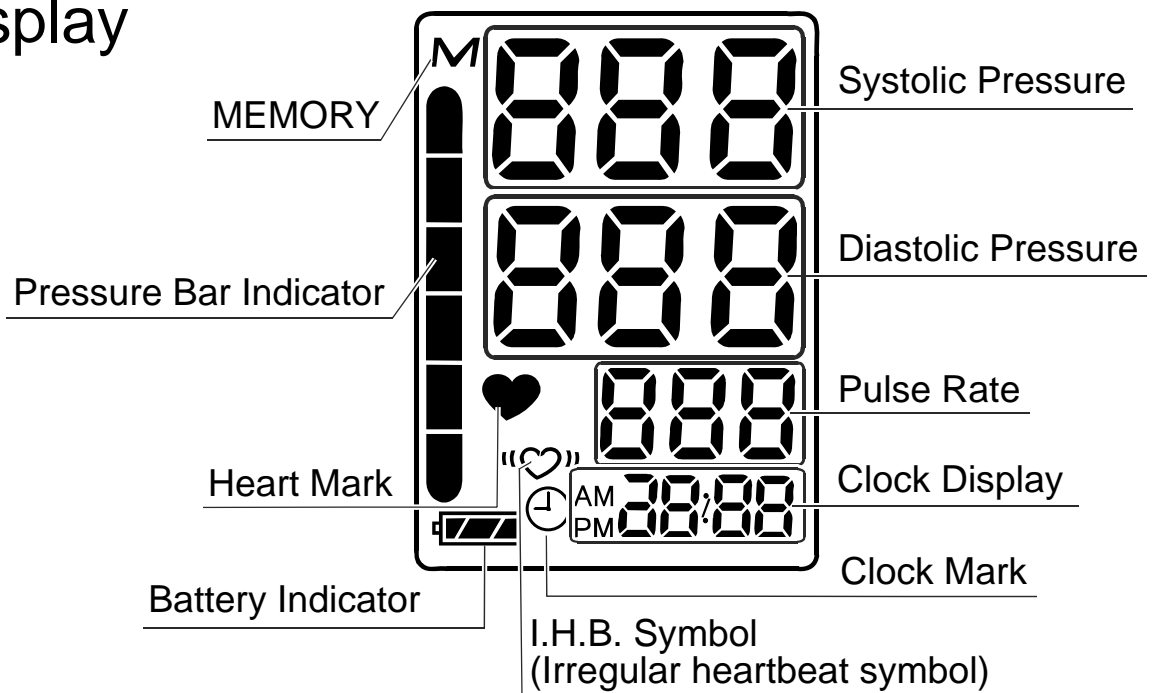



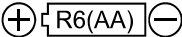

## Display





# Symbols









Symbols that are printed on the device case

Symbols	Function / Meaning	Recommended Action
	Standby and Turn the device on.	_____
SYS.	Systolic blood pressure in mmHg	_____
DIA.	Diastolic blood pressure in mmHg	_____
PUL./min.	Pulse per minute	_____
	Battery installation guide	_____
	Direct current	_____
SN	Serial number	_____
2010 	Date of manufacture	_____
	Type BF: Device, cuff and tubing are designed to provide special protection against electrical shocks.	_____
	EC directive medical device label	_____
	WEEE label	_____
	Manufacturer	_____
	EU-representative	_____

Symbols that appear on the display

Symbols	Function / Meaning	Recommended Action
	Appears while measurement is in progress. It blinks when the pulse is detected.	Measurement is in progress. Remain as still as possible.
	<b>Irregular Heartbeat</b> symbol (I.H.B.) Appears when an irregular heartbeat is detected. It may light when a very slight vibration like shivering or shaking is detected.	_____
<b>M</b>	Previous measurements stored in memory.	_____

# Symbols

Symbols	Function / Meaning	Recommended Action
 Full Battery	The battery power indicator during measurement.	_____
 Low Battery	The battery is low when it blinks.	Replace all batteries with new ones when the mark blinks.
	Unstable blood pressure due to movement during measurement.	Take another measurement. Remain very still during measurement.
	The systolic and diastolic values are within 10 mmHg of each other.	Apply the cuff correctly, and take another measurement.
	The pressure value did not increase during the inflation.	
	The cuff is not applied correctly.	Apply the cuff correctly, and take another measurement.
 PUL. DISPLAY ERROR	The pulse is not detected correctly.	
	Cannot communicate.	The communication device may be slanted or placed out of the communication area of the blood pressure monitor.  Hold the communication symbol of the NFC-enabled communication device close to the communication area of the monitor until "End" appears.
		
		
	Appears during the clock setting procedure	_____
AM	Time between 0:00 and 11:59	_____
PM	Time between 12:00 and 23:59	_____

# Operation Mode

## 1. Normal Measurement

Press the **START** button. Blood pressure is measured and the data is stored in memory.

## 2. Memory Function

This monitor can store the last 100 measurements in memory.

When the measurement exceeds 100, the oldest data will be deleted automatically and the most recent data will be stored.

This monitor does not display the data stored in memory. The memory data can only be read by an NFC-enabled device.

## 3. Deleting all Data Stored in Memory

Make sure that the monitor displays the clock.

Press and hold the ► button.

The **M** mark appears. After a while it starts blinking, then disappears.

Now all data stored in memory has been deleted.

Note: This operation will delete all data stored in memory. You cannot select which data to delete.

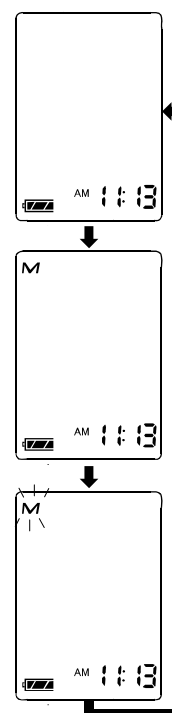

## 4. Measurement with the Desired Systolic Pressure

Refer to page 13 for measurement with the desired systolic pressure.



# Using the Monitor

## Installing / Changing the Batteries

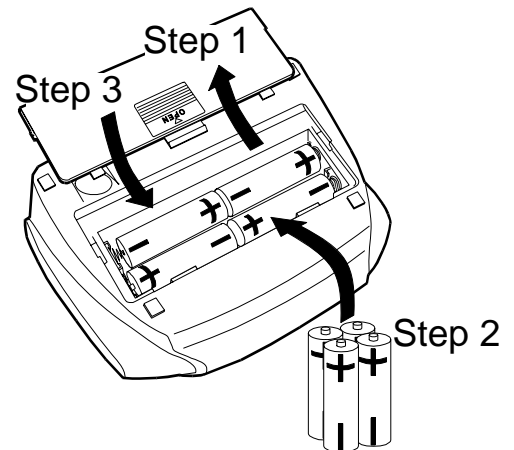
1. Slide the battery cover up to open it.
2. Remove the used batteries and insert new batteries into the battery compartment as shown, taking care that the polarities (+ and -) are correct. Use only R6P, LR6 or AA batteries.
3. Slide the battery cover down to close.



## CAUTION

- Insert the batteries as shown in the battery compartment. If installed incorrectly, the device will not work.
- When  (LOW BATTERY mark) blinks on the display, replace all batteries with new ones. Do not mix old and new batteries. It may shorten the battery life, or cause the device to malfunction. Wait two seconds or more after turning the device off, to replace the batteries. If  (LOW BATTERY mark) appears even after the batteries are replaced, make a blood pressure measurement. The device may then recognize the new batteries.
-  (LOW BATTERY mark) does not appear when the batteries are drained.
- The battery life varies with the ambient temperature and may be shorter at low temperatures.
- Use the specified batteries only.
- Remove the batteries if the device is not to be used for a long time. The batteries may leak and cause a malfunction.

## Connecting the Air Hose

Insert the air connector plug into the air socket firmly.

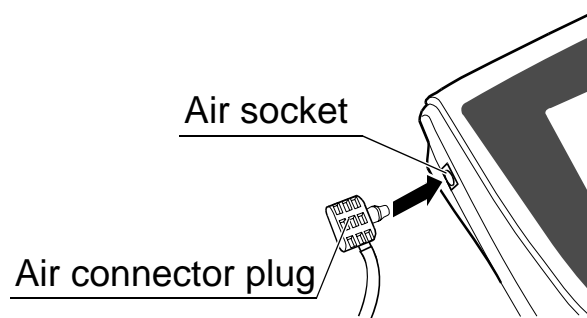

## Connecting the AC Adapter

Insert the AC adapter plug into the DC jack.

Next, connect the AC adapter to an electrical outlet.

- Use the specified AC adapter. (Refer to page 18.)

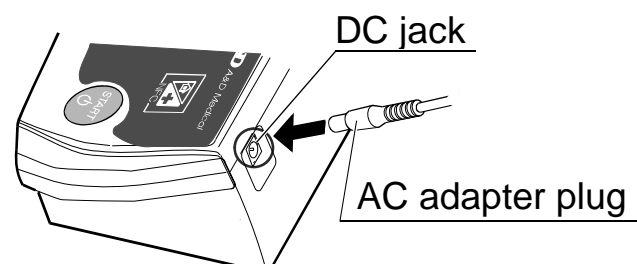



# Using the Monitor

## Notes on the Built-in Clock

- ❑ The monitor displays the clock as long as power is connected.
- ❑ Adjust the clock prior to use.
- ❑ The current clock setting will be cleared if the batteries are removed, or power is not connected for approximately 30 seconds while the AC adapter is used. In this case, adjust the clock again.
- ❑ When adjusting the clock, press the ► button to increase the value by one, or press and hold the ► button to change the value continuously.
- ❑ The setting procedure cannot be reversed. If the wrong value is set, start the setting procedure again.
- ❑ After 30 seconds of non-operation, the setting procedure will be automatically canceled.
- ❑ To cancel the operation anytime, press the **START** button.
- ❑ During measurement, the clock adjustment is not available.

## Selecting the Clock Mode





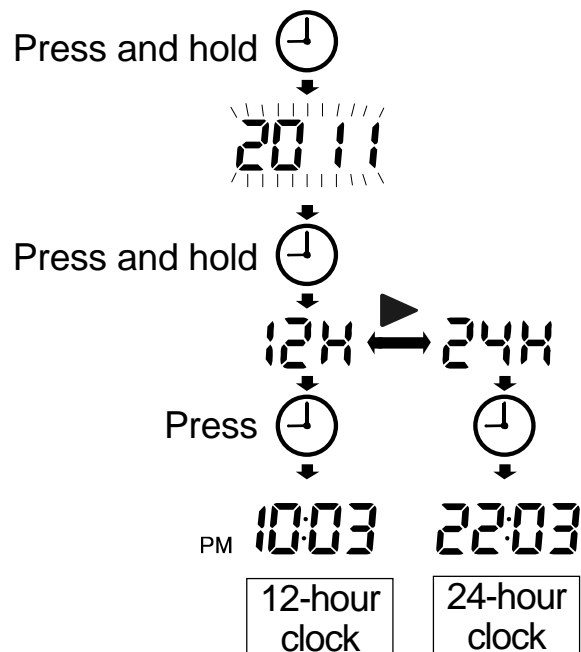





Two clock modes are available, 12-hour clock or 24-hour clock.

1. Press and hold the ⌚ button until the year starts blinking.
2. Press and hold the ⌚ button. "12H" appears on the display.
3. Press the ► button to switch between "12H" and "24H".
4. Press the ⌚ button to display the clock in the selected mode.



# Using the Monitor

## Adjusting the Clock

1. Press and hold the  button until the year starts blinking.
2. Select the year using the  button. Press the  button to set the current year and move to month/day selection. The date can be set anywhere between the years 2011 and 2055.
3. Select the month using the  button. Press the  button to set the current month and move to day selection.
4. Select the day using the  button. Press the  button to set the current day and move to hour/minute selection.
5. Select the hour using the  button. Press the  button to set the current hour and move to minute selection.
6. Select the minute using the  button. Press the  button to set the current minute and activate the clock.

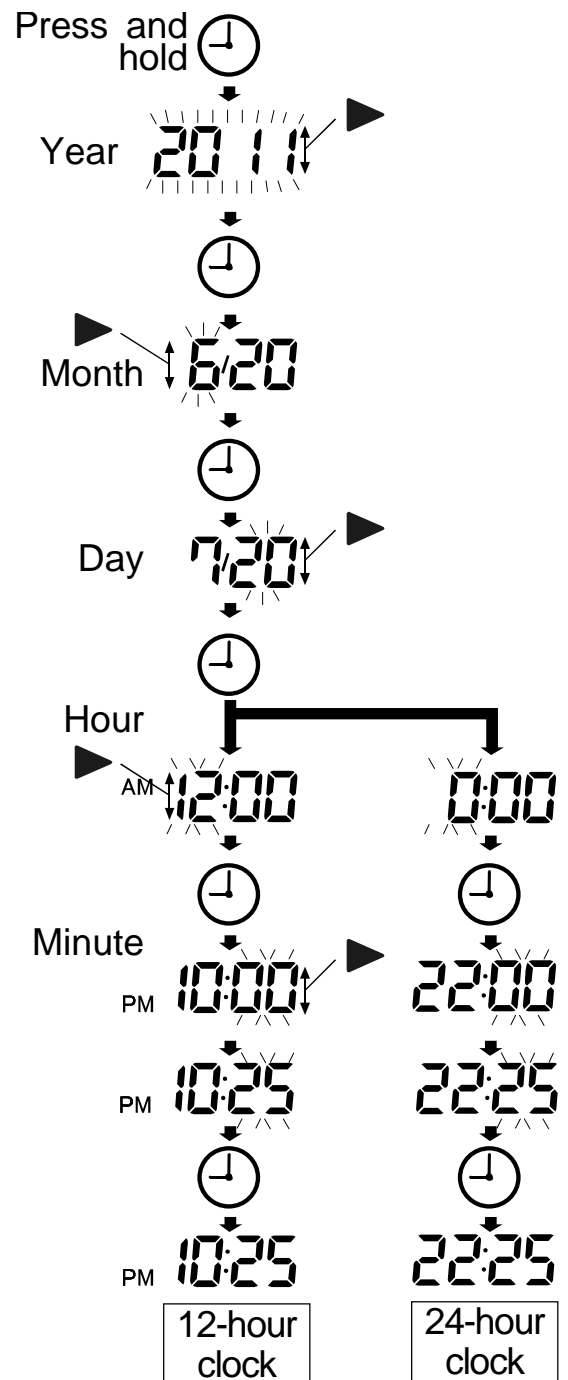

# Using the Monitor

## Selecting the Correct Cuff Size

Using the correct cuff size is important for an accurate reading. If the cuff is not the proper size, the reading may yield an incorrect blood pressure value.

- The arm size is printed on each cuff.
- The index ▲ and proper fit range, on the cuff, tell you if you are applying the correct cuff. (Refer to "Symbols that are printed on the cuff" on the next page)
- If the index ▲ points outside of the range, contact your local dealer to purchase a replacement cuff.
- The arm cuff is a consumable. If it becomes worn, purchase a new one.

Arm Size	Recommended Cuff Size	Catalog Number
31 cm to 45 cm	Large adult cuff	UA-CUFFBKLA-EC
22 cm to 32 cm	Adult Cuff	UA-CUFFBKAU-EC
16 cm to 24 cm	Small Adult Cuff	UA-CUFFBKSA-EC

Arm size: The circumference of the biceps.

## Applying the Arm Cuff

1. Wrap the cuff around the upper arm, about 1-2 cm above the inside of the elbow, as shown. Place the cuff directly against the skin, as clothing may cause a faint pulse, and result in a measurement error.
2. Constriction of the upper arm, caused by tightly rolling up a shirtsleeve, may prevent accurate readings.
3. Confirm that the index ▲ points within the proper fit range.

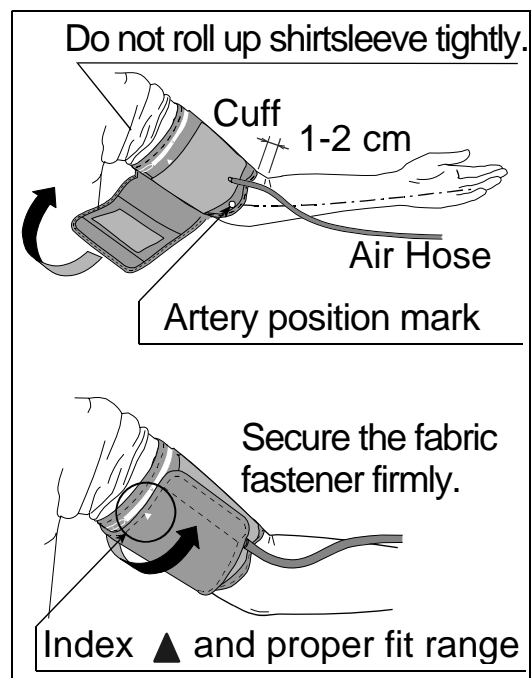

# Using the Monitor

Symbols that are printed on the cuff

Symbols	Function/Meaning	Recommended Action
●	Artery Position Mark	Set the ● mark on the artery of the upper arm or in line with the ring finger on the inside of the arm.
▲	Index	_____
REF	Catalog number	_____
<b>A</b>	Proper fit range for Adult Cuff It's printed on the Adult Cuff.	_____
<b>L</b>	Range to use Large Adult Cuff It's printed on the Adult Cuff.	Use Large Adult Cuff instead of Adult Cuff.
<b>L</b>	Proper fit range for Large Adult Cuff It's printed on the Large Adult Cuff.	_____
<b>S</b>	Range to use Small Adult Cuff It's printed on the Adult Cuff.	Use Small Adult Cuff instead of Adult Cuff.
<b>S</b>	Proper fit range for Small Adult Cuff It's printed on the Small Adult Cuff.	_____
<b>A</b>	Range to use Adult Cuff It's printed on the Large Adult Cuff and Small Adult Cuff.	Use Adult Cuff instead of Large Adult Cuff or Small Adult Cuff.
LOT	Lot number	_____

## How to Take Proper Measurements

For the most accurate blood pressure measurement:

- Sit comfortably at a table. Rest your arm on the table.
- Relax for about five to ten minutes before measurement.
- Place the center of the cuff at the same height as your heart.
- Remain still and keep quiet during measurement.
- Do not measure right after physical exercise or a bath. Rest for twenty or thirty minutes before taking the measurement.
- Try to measure your blood pressure at the same time every day.

## Measurement

During measurement, it is normal for the cuff to feel very tight. (Do not be alarmed).

## After Measurement

After measurement, press the **START** button to turn the device off. After one minute of non-operation, the device will turn off automatically.

Remove the cuff and record your data.

Note: Allow at least three minutes between measurements on the same person.

# Measurements

Before measurement, read “Notes for Proper Measurement” on the next page.

## Normal Measurement

1. Place the cuff on the arm (preferably the left arm).  
Sit quietly during measurement.

2. Press the **START** button.  
The number of data stored in memory is displayed.

Zero (0) is displayed blinking briefly.  
The display changes, as indicated in the figure at the right, as the measurement begins. The cuff starts to inflate. It is normal for the cuff to feel very tight. A pressure bar indicator is displayed, on the left edge of the display, during the inflation.

Note: If you wish to stop inflation at any time, press the **START** button again.

3. When inflation is complete, deflation starts automatically and ♥ (heart mark) blinks, indicating that the measurement is in progress. Once the pulse is detected, the mark blinks with each pulse beat.

Note: If an appropriate pressure is not obtained, the device starts to inflate again automatically.  
To avoid re-inflation, see “Measurement with the Desired Systolic Pressure” on the next page.

4. When the measurement is complete, the systolic and diastolic pressure readings and pulse rate are displayed.  
The cuff exhausts the remaining air and deflates completely.

5. Press the **START** button to turn the device off.  
After one minute of non-operation, the device will turn off automatically.

Note: Allow at least three minutes between measurements on the same person.

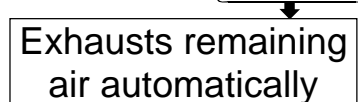
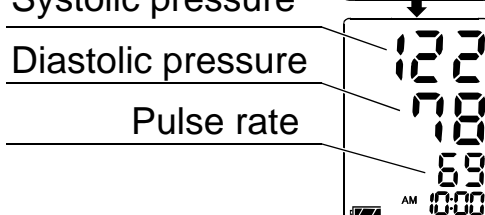
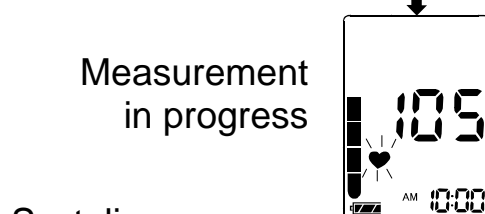
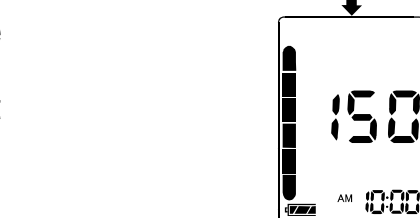
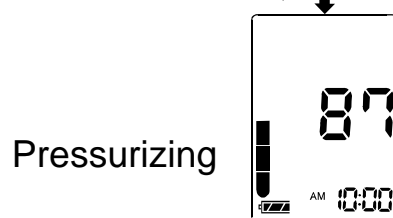
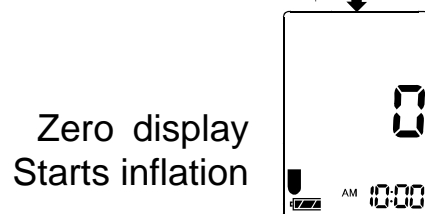
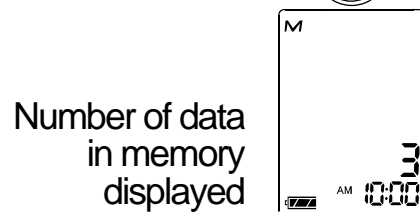
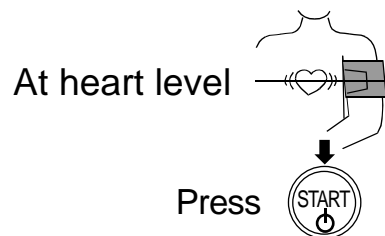

# Measurements

## Measurement with the Desired Systolic Pressure

Model UA-767NFC is designed to detect the pulse and to inflate the cuff to a systolic pressure level automatically.

Use this method when re-inflation occurs repeatedly or when the results are not displayed even if the pressure decreases to 20 mmHg or less.

1. Place the cuff on the arm (preferably the left arm).
2. Press and hold the **START** button until a number about 30 to 40 mmHg higher than your expected systolic pressure appears.
3. When the desired number is reached, release the **START** button to start measurement. Continue to measure your blood pressure as described on the previous page.

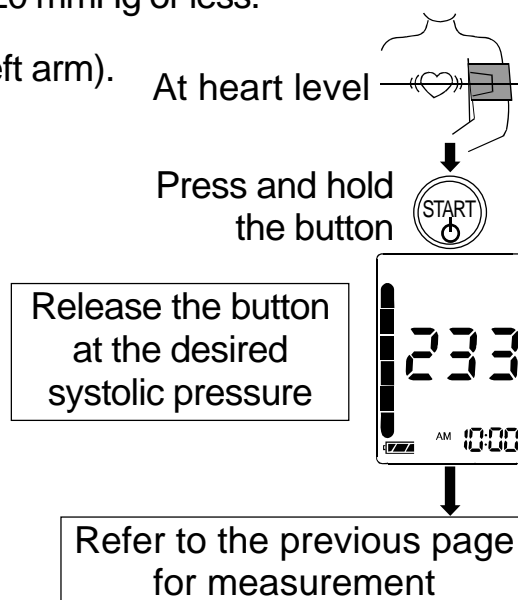

## Notes for Proper Measurement

- Sit down in a comfortable position. Place your arm on a table with your palm facing upward and the cuff at the same level as your heart.
- Relax for about five to ten minutes before taking a measurement. If you are excited or depressed by emotional stress, the measurement will reflect this stress as a higher (or lower) than normal blood pressure reading and the pulse reading will usually be faster than normal.
- An individual's blood pressure varies constantly, depending on what you are doing and what you have eaten. What you drink can have a very strong and rapid effect on your blood pressure.
- This device bases its measurements on the heartbeat. If you have a very weak or irregular heartbeat, the device may have difficulty determining your blood pressure.
- Should the device detect a condition that is abnormal, it will stop the measurement and display an error symbol. Refer to page 5 for the description of symbols.
- This blood pressure monitor is intended for use by adults only. Consult with your physician before using this device on a child. A child should not use this device unattended.

# Near Field Communication (NFC) Function

To transmit data to or from the blood pressure monitor, communication devices that comply with the communication specifications of the blood pressure monitor are required.

Examples of communication devices that comply

- NFC-enabled cellular phone
- Personal computer with NFC reader/writer
- Access Point

## Memory Data Transmission

While the blood pressure monitor displays the clock, hold the communication symbol of the NFC-enabled communication device close to the communication area (  ) of the monitor until “End” appears.

The memory data transmission is performed.

If the clock of the blood pressure monitor is not correct, the clock will be updated at the same time.

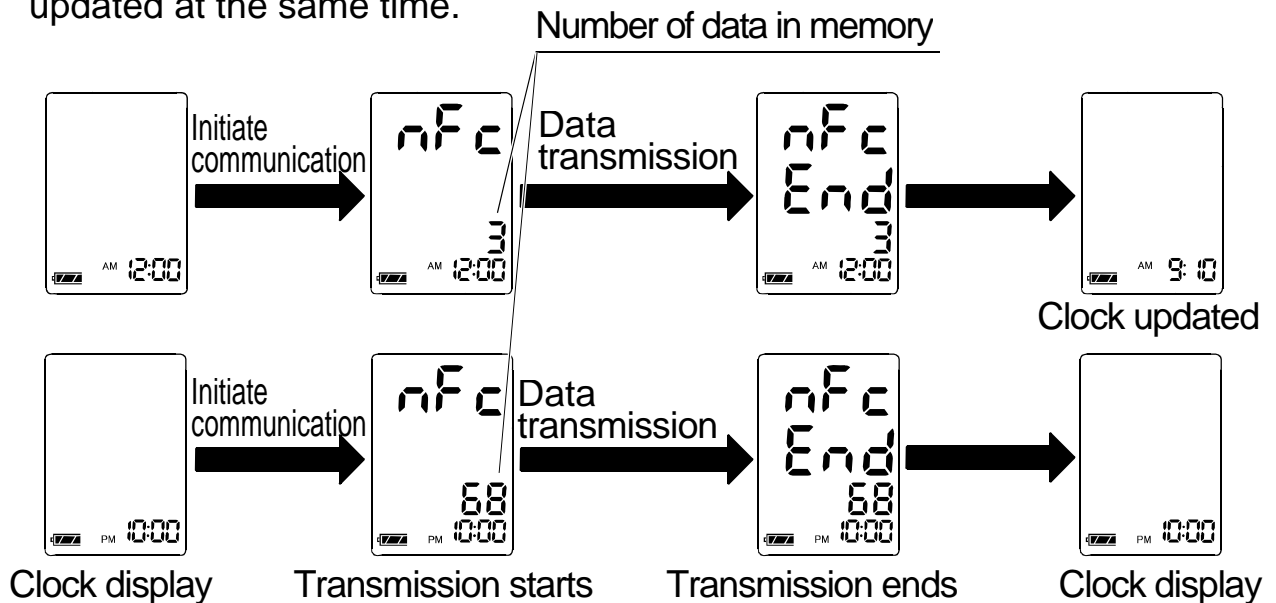

## Measurement Data Transmission

When the measurement is complete and the monitor displays the results, hold the communication symbol of the NFC-enabled communication device close to the communication area (  ) of the monitor until “End” appears.

The data transmission is performed.

If the clock of the blood pressure monitor is not correct, the clock will be updated at the same time.

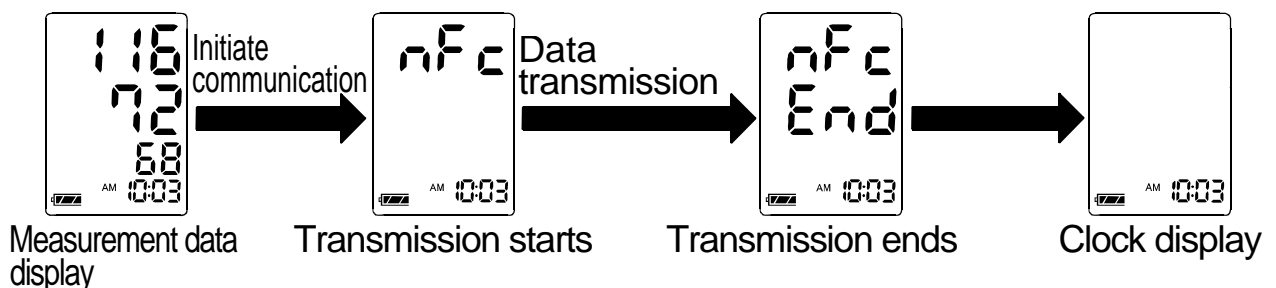

## Caution on Using the NFC Function

The UA-767NFC blood pressure monitor has an NFC Forum Type 3 Tag wireless interface module built in.

When the monitor is used near wireless communication devices which use the same frequency as that of the monitor (13.56 MHz) or use its harmonic frequencies, electromagnetic interference may occur. In that case, turn off the devices that are not in use, or place the monitor 1 meter or more away from the devices.

## What is an Irregular Heartbeat

The UA-767NFC blood pressure monitor provides a blood pressure and pulse rate measurement even when an irregular heartbeat occurs. An irregular heartbeat is defined as a heartbeat that varies by 25% from the average of all heartbeats during the blood pressure measurement. It is important that you are relaxed, remain still and do not talk during measurements.

Note: We recommend contacting your physician if you see this ((♡)) indicator frequently.

## Pressure Bar Indicator

The indicator monitors the progress of pressure during measurement.

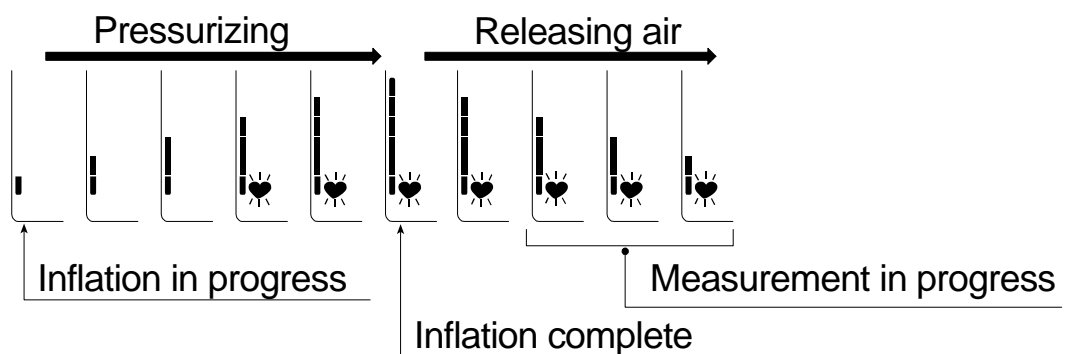

## About Blood Pressure

### What is Blood Pressure?

Blood pressure is the force exerted by blood against the walls of the arteries. Systolic pressure occurs when the heart contracts. Diastolic pressure occurs when the heart expands. Blood pressure is measured in millimeters of mercury (mmHg). One's natural blood pressure is represented by the fundamental pressure, which is measured first thing in the morning while one is still at rest and before eating.



# About Blood Pressure

## What is Hypertension and How is it Controlled?

Hypertension, an abnormally high arterial blood pressure, if left unattended, can cause many health problems including stroke and heart attack. Hypertension can be controlled by altering lifestyle, avoiding stress, and with medication under a doctor's supervision.

To prevent hypertension or keep it under control:

- Do not smoke
- Exercise regularly
- Reduce salt and fat intake
- Have regular physical checkups
- Maintain proper weight

## Why Measure Blood Pressure at Home?

Blood pressure measured at a clinic or doctor's office may cause apprehension and can produce an elevated reading, 25 to 30 mmHg higher than that measured at home. Home measurement reduces the effects of outside influences on blood pressure readings, supplements the doctor's readings and provides a more accurate, complete blood pressure history.

## WHO Blood Pressure Classification

Standards to assess high blood pressure, without regard to age, have been established by the World Health Organization (WHO), as shown in the chart.

Reference Material: Journal of Hypertension 1999, Vol 17 No.2

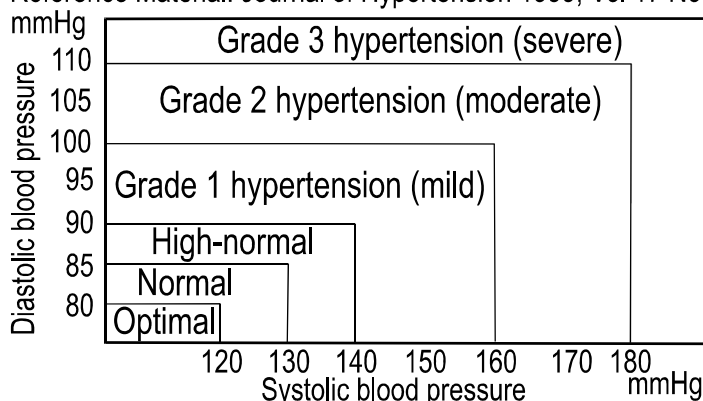

## Blood Pressure Variations

An individual's blood pressure varies greatly on a daily and seasonal basis. It may vary by 30 to 50 mmHg due to various conditions during the day. In hypertensive individuals, variations are even more pronounced. Normally, the blood pressure rises while at work or play and falls to its lowest levels during sleep. So, do not be overly concerned by the results of one measurement. Take measurements at the same time every day using the procedure described in this manual to get to know your normal blood pressure. Regular readings give a more comprehensive blood pressure history. Be sure to note the date and time when recording your blood pressure. Consult your doctor to interpret your blood pressure data.

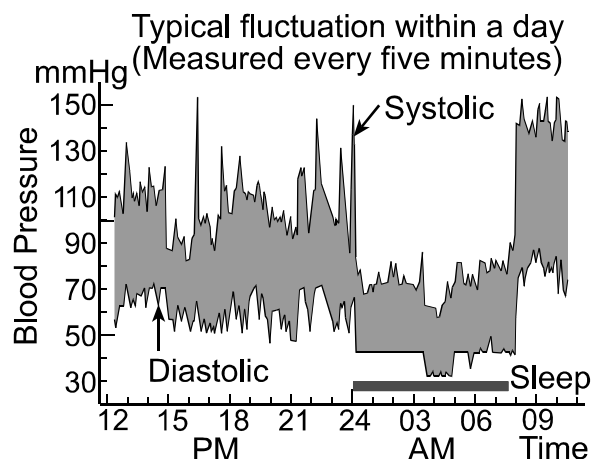

# Troubleshooting

Problem	Possible Reason	Recommended Action
Nothing appears on the display, even when the power is turned on.	Batteries are drained.	Replace all batteries with new ones.
	Battery terminals are not in the correct position.	Reinstall the batteries with negative and positive terminals matching those indicated on the battery compartment.
The cuff does not inflate.	Battery voltage is too low.  (LOW BATTERY mark) blinks. If the batteries are drained completely, the mark does not appear.	Replace all batteries with new ones.
The device does not measure. Readings are too high or too low.	The cuff is not applied properly.	Apply the cuff correctly.
	You moved your arm or body during measurement.	Make sure you remain very still and quiet during measurement.
	The cuff position is not correct.	Sit comfortably and still. Place your arm on a table with your palm facing upward and the cuff at the same level as your heart.
	_____	If you have a very weak or irregular heart beat, the device may have difficulty in determining your blood pressure.
Other	The value is different from that measured at a clinic or doctor's office.	Refer to "Why Measure Blood Pressure at Home?".
	_____	Remove the batteries. Place them back properly and take another measurement.



Note: If the actions described above do not solve the problem, contact the dealer. Do not attempt to open or repair this product, as any attempt to do so will make your warranty invalid.

# Maintenance

Do not open the device. It uses delicate electrical components and an intricate air unit that could be damaged. If you cannot fix the problem using the troubleshooting instructions, contact the authorized dealer in your area or our customer service department. The A&D customer service will provide technical information, spare parts and units to authorized dealers.

The device was designed and manufactured for a long service life. However it is generally recommended to have the device inspected every 2 years, to ensure proper functioning and accuracy. Please contact the authorized dealer in your area or A&D for maintenance.

# Technical Data

Type	UA-767NFC
Measurement method	Oscillometric measurement
Measurement range	Pressure: 0 - 280 mmHg Pulse: 40 - 180 beats / minute
Measurement accuracy	Pressure: $\pm 3$ mmHg Pulse: $\pm 5\%$
Power supply	4 x 1.5V batteries (R6P, LR6 or AA) or AC adapter (TB-233) (Not included)
Classification	Type BF 
Clinical test	According to ANSI / AAMI SP-10 1992
EMC	IEC 60601-1-2: 2007
Memory	Last 100 measurements
Operating condition	+10°C to +40°C / 30%RH to 85%RH
Storage condition	-10°C to +60°C / 30%RH to 95%RH
Dimensions	Approx. 147 [W] x 64 [H] x 110 [D] mm
Weight	Approx. 300 g, excluding the batteries
	 0366
Wireless communication	NFC wireless interface module
Accessory AC adapter	The adapter is to connect the blood pressure monitor to a power source at home. Please contact your local A&D dealer for purchasing.
	TB-233

Note: Specifications are subject to change without prior notice.

EMC table information is listed on our website:

[http://www.aandd.jp/products/manual/medical/emc\\_acadapter\\_en.pdf](http://www.aandd.jp/products/manual/medical/emc_acadapter_en.pdf)



**A&D Company, Limited**

1-243 Asahi, Kitamoto-shi, Saitama 364-8585 JAPAN  
Telephone: [81] (48) 593-1111 Fax: [81] (48) 593-1119



**A&D INSTRUMENTS LTD.**

Unit 24/26 Blacklands Way, Abingdon Business Park, Abingdon, Oxfordshire OX14 1DY United Kingdom  
Telephone: [44] (1235) 550420 Fax: [44] (1235) 550485

**A&D Australasia Pty Ltd.**

32 Dew Street, Thebarton, South Australia 5031 AUSTRALIA  
Telephone: [61] (8) 8301-8100 Fax: [61] (8) 8352-7409

**A&D ENGINEERING, INC.**

1756 Automation Parkway, San Jose, California 95131 U.S.A.  
Telephone: [1] (408) 263-5333 Fax: [1] (408)263-0119

**A&D KOREA Limited**

한국에이.엔.디(주)  
대한민국 서울시 영등포구 여의도동 36-2 맨하탄 빌딩 8층  
(8th Floor, Manhattan Bldg. 36-2 Yoido-dong, Youngdeungpo-ku, Seoul, KOREA )  
Telephone: [82] (2) 780-4101 Fax: [82] (2) 782-4280