

zibro®

SRE 170 TC



guarantee

2

YEARS

F	MANUEL D'UTILISATION	2
D	GEBRAUCHSANWEISUNG	12
DK	BRUGSANVISNING	22
E	INSTRUCCIONES DE USO	32
GB	OPERATING MANUAL	42
I	ISTRUZIONI D'USO	52
NL	GEBRUIKSAANWIJZING	62
PL	INSTRUKCJI OBSŁUGI	72

Dear Sir, Madam,

Congratulations with your purchase of the Zibro, the number one brand among movable heaters. You have purchased a first-class quality product, which will serve you for many years to come. This, of course, provided you use the heater correctly. Please read these Directions for Use first, to ensure maximum lifetime for your Zibro .

Your heater comes with a 24-month manufacturer's warranty on all defects in material or workmanship.

We wish you much warmth and comfort with your Zibro.

Yours sincerely,

PVG International b.v.

Customer Service Department

1 READ THE DIRECTIONS FOR USE FIRST.



2 IN CASE OF ANY DOUBT, CONTACT YOUR ZIBRO DEALER.

3 BEFORE YOU START READING, FOLD OUT THE LAST PAGE.



GENERAL DIRECTIONS FOR USE

Below you will find the main steps to be taken for using your Zibro. For more details, please refer to the MANUAL (pages 45 ff.).

- 1** Remove all packaging materials (Fig. A).
- 2** Fill the removable tank **7** (refer to Section B, Fig. D).
- 3** Insert the plug into the wall-socket.
- 4** Ignite the heater using the  key **13** (refer to Section D).
- 5** If required, change the temperature using the adjustment keys (refer to Section E).
- 6** Switch off the heater by pressing the  key **13**.

- The first time you ignite your heater it will smell like 'new' for a short time.
- Store your fuel in a cool and dark place.
- Fuel has a limited shelf life. Start every heating season with renewed fuel.
- The right quality of fuel will be assured, when you use Zibro Extra or Zibro Kristal for your heater.
- If you change to another brand and/or type of paraffin oil, you must first finish up all the remaining fuel in the heater.

MAIN COMPONENTS

- 1** Front plate
- 2** Grid
- 3** Base plate
- 4** Lid for removable tank
- 5** Operation panel
- 6** Handle
- 7** Removable tank
- 8** Air filter cap
- 9** Vent filter
- 10** Thermostat
- 11** Plug + cord
- 12** Information display
- 13**  key
- 14** Childproof lock
- 15** Adjustment keys (time and temperature)
- 16** TIMER
- 17** SAVE key
- 18** Indicator lights
- 19** Connection weektimer
- 20** EXTENSION

WHAT YOU NEED TO KNOW IN ADVANCE

ALWAYS MAKE SURE THAT THERE IS SUFFICIENT VENTILATION

For each model the minimum size of space is specified in which you can use the heater safely, without additional ventilation (*refer to Section P*). If a particular room is smaller than the specified space, always leave a window or door slightly ajar (± 2.5 cm). We also recommend doing this in highly insulated or draught-free rooms and/or at altitudes above 1,500 metres. However, if there is insufficient ventilation (i.e. oxygen), the heater will automatically switch off. Do not use your heater in cellars or other underground areas.



Only the use of the correct fuel will ensure safe, efficient, and comfortable use of your Zibro.



THE RIGHT FUEL

Only use Class C1 paraffin fuel in accordance with BS2869: Part 2, or equivalent. Your Zibro heater has been designed for use with high-quality water-free pure paraffin oil, such as Zibro Extra or Zibro Kristal. Only fuels of this kind will ensure clean and proper burning. Lower quality fuel may result in:

- ▶ increased possibility of malfunctioning
- ▶ incomplete burning
- ▶ reduced heater lifetime
- ▶ smoke and/or smells
- ▶ deposits on the grid or mantle

Using the right fuel is therefore essential for safe, efficient, and comfortable use of your heater.

Always refer to your local Zibro dealer for the right fuel for your heater.

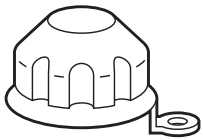

The fuel cap cover can be found at the rear of the heater. This cover allows you to keep your hands clean when opening the fuel tank.

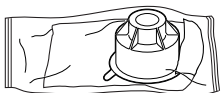

This transportation cap is packed separately in the box. Only this cap ensures trouble-free transportation of the heater after use. Store it well!

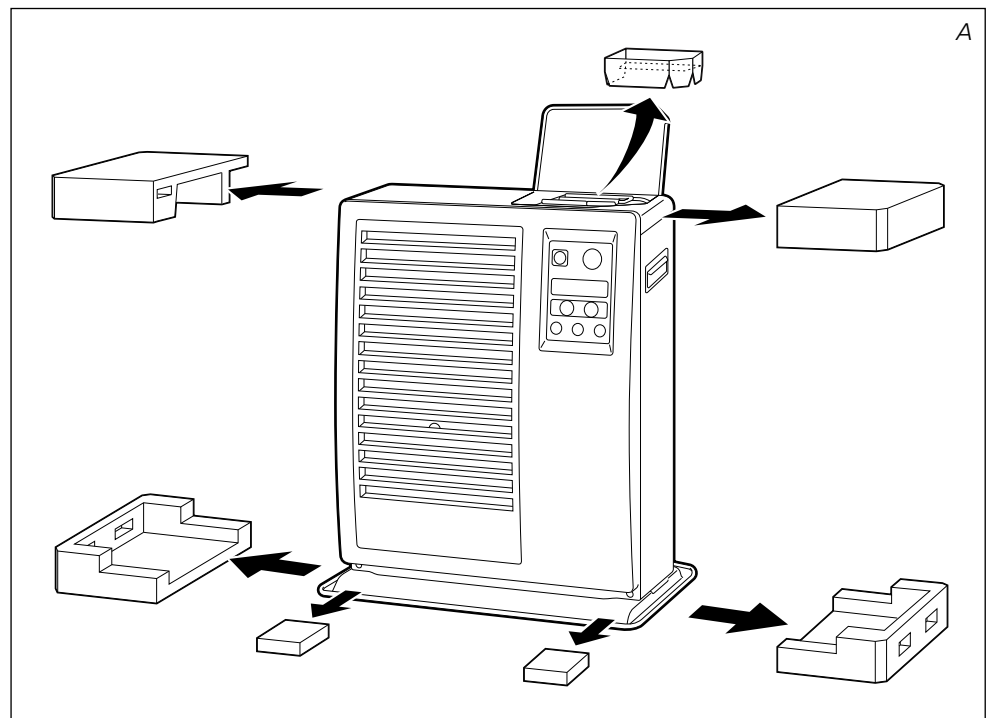

A INSTALLING THE HEATER

- 1 Carefully remove your Zibro from the box and check the contents. In addition to the heater you also need to have:
 - ▶ a manual fuel pump
 - ▶ a transportation cap
 - ▶ a fuel cap cover
 - ▶ these directions for use

Keep the box and the packaging materials (Fig. A) for storage and/or transportation.

- 2 Open the lid of the removable tank 4 and remove the piece of cardboard.
- 3 Fill the removable tank as indicated in Section B.
- 4 The floor should be firm and completely level. Reposition the heater, when it is not level. Do not try to correct the situation by placing books or other goods under the heater.
- 5 Insert the plug 11 into the wall-socket (230 Volts - AC / 50 Hz) and set the correct time using the adjustment keys 15 (refer to Section C).

- 6 Your Zibro is now ready for use.

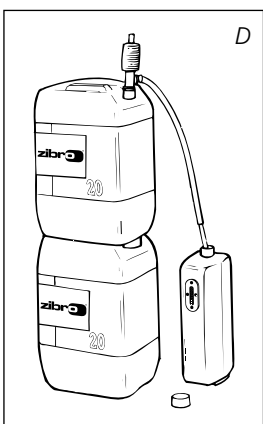
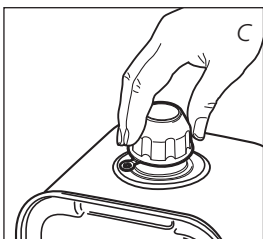
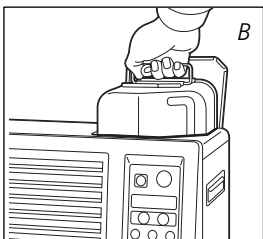

B FILLING FUEL

Do not fill the removable tank in the living room, but in a more suitable place (there can always be some spillage). Follow the procedure below:

- 1 Make sure that the heater is switched off.
- 2 Open the lid 4 and lift the removable tank 7 out of the heater (Fig. B). Note: Some drops may leak from the tank. Put down the removable tank (cap pointing upwards) and screw off the fuel cap using the fuel cap cover (Fig. C).
- 3 Take the manual fuel pump and insert the smooth, most rigid tube into the jerrycan. Make sure that it is in a higher position than the removable tank (Fig. D). Insert the ribbed hose into the opening of the removable tank.
- 4 Lock the switch button on top of the pump (turn clockwise).
- 5 Squeeze the pump a few times, until fuel starts flowing into the removable tank. As soon as this happens, there is no need to press any longer.

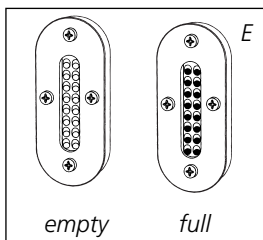

- 6 Check the removable tank fuel gauge 7 while filling the tank (Fig. E). Stop filling by loosening the switch button on top of the pump (turn anti-clockwise), once the gauge indicates that the tank is full. Never overfill the tank, especially not when the fuel is very cold (fuel expands when it heats up).
- 7 Let the remaining fuel in the pump flow back into the jerrycan and carefully remove the pump. Carefully screw the fuel cap back on the tank using the fuel cap cover. After use, re-store the cover at the rear of the heater. Clean off any spilled fuel.
- 8 Check whether the fuel cap is straight and tightened properly. Reinstall the removable tank in the heater (cap down). Close the lid.

C SETTING THE CLOCK

It is only possible to set the correct time, when the heater is connected to the mains and not burning. Use the adjustment keys 15 to set the time. First press either of the two keys to switch on the function (the CLOCK light and the information display 12 will start blinking). Next, set the hours using the key on the left (▼hour) and the minutes using the key on the right (▲min.). Press once to increase the value by one step. When you hold down the key, the value will continue going up, until you release the key again. After approximately 10 seconds the blinking will stop and the setting will be locked. 5 minutes after switching off the heater, the information on the display will disappear and the heater will automatically switch into the stand-by position.



F: When the CLOCK indicator light stops blinking, the setting has been locked to the indicated value.



When the heater has been unplugged for more than 10 minutes (or after a power failure), the time needs to be set again.

D IGNITING THE HEATER

When used for the first time, a new heater may give out a smell for a short while. You should therefore provide extra ventilation.

Always ignite the heater with the ⏻ button 13. Never use matches or a cigarette lighter. Just press the ⏻ button 13 to ignite the heater. The button will start blinking, indicating that the ignition procedure has started. This will take a short while. Once the heater is burning, the ⏻ button 13 will remain lit (red). The information display 12 will show two numbers. The light next to them indicates that these numbers refer to the temperatures (Fig. G). The actual room temperature is indicated below ROOM, while the temperature setting is indicated below SET. The latter can be changed with the adjustment keys (refer to Section E). Prior to igniting the heater, always check for sufficient fuel in the removable tank.



G: The required temperature on the left, the measured temperature on the right.



E SETTING THE REQUIRED TEMPERATURE

The temperature setting can only be adjusted, when the heater is burning. Use the adjustment keys 15 to adjust the temperature. First press either of the two keys to switch on the function (the TEMP light next to the information display 12 will start blinking). Next, adjust the temperature using the key on the right (▲min.) to set the temperature to a higher setting and the key on the left (▼hour) to lower the temperature. Press once to increase the value one step. After approximately 10 seconds the light will stop blinking and the setting will be locked (Fig. G). The available temperature settings range from 6°C minimum to 28°C maximum.

When the heater has been unplugged (or after a power failure), the temperature will reset to the factory setting of 20°C.

F USING THE TIMER

The timer allows you to switch on the heater automatically at a preset time. In order to switch on the timer, the correct time must have been set (refer to Section C) and the heater should be off. Follow the procedure below:

- 1 Press the  button **13** and then the **TIMER** key **16** immediately after that. The **TIMER** light and the information display **12** will start blinking.
- 2 Use the adjustment keys **15** to set the time at which the heater must ignite. Use the key on the left ( hour) to set the hours and the key on the right ( min.) to set the minutes (interval of 5 minutes).
- 3 After approximately 10 seconds the information display will show **CLOCK** again and the **TIMER** indicator light will light up, indicating that the timer function has been activated (Fig. H).
- 4 The timer will ensure that the room will have been heated to approximately the required temperature at the set time.



H: The **TIMER** indicator light indicates that the timer function has been switched on.



When you want to switch off the heater and ignite it again with the timer, all you have to do is press the **TIMER** key (refer to Section G).

Press the  button **13** once to clear the timer setting.



If you would like more extensive timer possibilities, we advise you to procure the Zibro weektimer. This timer is easy to connect with your Zibro Heater, see **19**.

G SWITCHING OFF THE HEATER

There are two ways to switch off the heater.

- 1 Press the  button **13**. The information display will show the **CLOCK** signal. Within approximately one minute the flame will have extinguished.
- 2 Press the **TIMER** key **16**, when you want to switch off the heater and ignite it again with the timer the next time. This not only switches off the heater, but it also activates the timer function. You can change the required time with the adjustment keys **15** (refer to Section F).

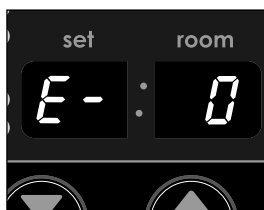

In case of any malfunctioning the information display will tell you what is the matter.

H THE INFORMATION DISPLAY

The information display **12** not only serves as an indicator of the (set) time and temperature (Sections C, E, and F), it also indicates any malfunctioning of the heater. The code on the information display tells you what is the matter:



CODE	INFORMATION	WHAT TO DO
E - 0	Temperature within the heater too high.	Cool-down and re-ignite.

<i>F - 0</i>	Power interrupted.	Re-ignite the heater.
<i>E - 1</i>	Faulty thermostat.	Contact your dealer.
<i>F - 1</i>	Faulty burner thermistor.	Contact your dealer.
<i>E - 2</i>	Starting problems.	Contact your dealer.
<i>E - 5</i>	Tipping-over protection.	Re-ignite the heater.
<i>E - 6</i>	Poor burning.	Contact your dealer.
<i>E - 7</i>	Room temperature above 32°C.	If necessary, re-ignite the heater.
<i>E - 8</i>	Defective booster.	Contact your dealer.
<i>E - 9</i>	Air filter dirty; or Fuel pump dirty.	Clean filter Contact your dealer.
<i>65 Hr</i>	The heater has been in operation continuously for a period of 65 hours and has turned itself off automatically.	Switch the heater back on. Refill removable tank.
<i>-- : --</i> (& blinking FUEL-light)	Out of fuel.	Refill removable tank.
<i>-- : --</i> (& blinking VENT-light)	Too little ventilation.	Ventilate better.

Always contact your Zibro dealer for any malfunctioning not listed above.



AUTOMATIC DEACTIVATION

This heater is fitted with a safety system that ensures that it switches off automatically after 65 hours continuous operation. The following will then appear in the display: *65 Hr*. If desired, you can switch the heater on again by pressing the  button  (see section D).



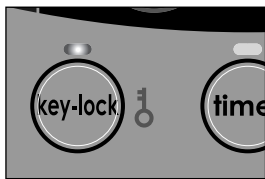

AUTOMATIC CLEANING MODE

When the heater has been burning continuously for two hours at its highest setting, the burner will automatically start an autoclean procedure. The display will show the autocleaning code *CL:05* running back to *CL:01*. The procedure takes 5 minutes, during which the heater will burn at its lowest setting, while the burner autocleans. When the burner is clean again, the heater will automatically switch back to the highest setting again.



I: When the KEY-LOCK light lights up, the childproof lock has been activated.

I CHILDPROOF LOCK

The childproof lock can be used to prevent children accidentally changing the heater settings. When the heater is burning and the childproof lock is on, the heater can only be switched off. Other functions are blocked then. If the heater has already been switched off, the childproof lock also prevents accidental ignition of the heater. Activate the childproof lock by pressing the appropriate key  and holding it down for more than 3 seconds. The KEY-LOCK indicator light will light up (Fig. I), indicating that the childproof lock has been activated. Switch off the childproof lock by pressing the key  and holding it down for more than 3 seconds once again.

J THE CORRECT USE OF 'SAVE'

The 'SAVE' function allows you to limit the temperature. When this function is activated, the heater will automatically switch off, when the room temperature exceeds the set temperature by 3°C. Subsequently, when the room temperature has dropped again to the set temperature, the heater will automatically switch on again.

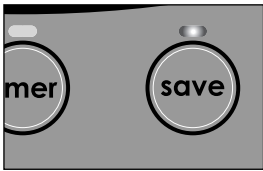

J: When the SAVE light lights up, the heater will automatically switch on or off in order to remain within a specified temperature range.



K: When the FUEL indicator light is lit, the information display will show the number of minutes of fuel left in the tank.

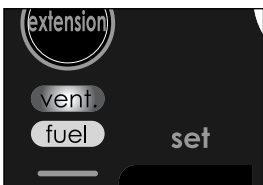

L: A blinking VENT indicator light is a sign that you need extra ventilation.

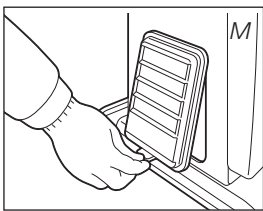

Fuel filter

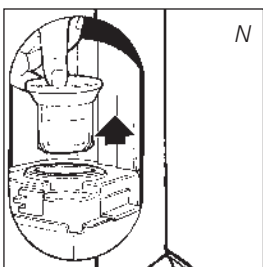
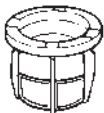

Activate the 'SAVE' setting by pressing the appropriate 17 key. The SAVE indicator light will light up (Fig. J). Switch off the function by pressing the SAVE key once again.



Without the 'SAVE' setting your heater will maintain the set temperature by approximation as well, by adjusting its heating capacity. 'SAVE' is an economy setting, which you can use when, for instance, you are not present in the room or to keep it frost-free.

K THE 'FUEL' INDICATOR LIGHT

When the indicator light FUEL lights up, it means that there is only fuel left for 10 more minutes. The count-down of the remaining heating time can be seen in the information display 12 (Fig. K). Now you have two options:

- ▶ you remove the fuel tank and refill it outside the living room (section B) or
- ▶ you push the button EXTENSION 20. By pushing this button, the remaining heating time will extend to 60 minutes. The heater will automatically switch back to its lowest position. In the display the number 60 will appear, which will decline to 10. At the arrival of 10, you will hear an alarm signal every two minutes, warning you to refill the removable tank.

L THE 'VENT' INDICATOR LIGHT

When the VENT indicator light starts blinking, this is a sign that the room is not vented sufficiently (Fig. L). If you do not provide additional ventilation, the heater will switch off automatically after some time.

If the indicator light continues blinking after extra ventilation, please contact your dealer.

M MAINTENANCE

Switch off the heater and let it cool down, before you start any maintenance work. Also disconnect the plug from the mains.

Your Zibro needs hardly any maintenance. It is, however, important that you clean the air filter cap 8 and the vent filter 9 with a vacuum cleaner and the grid 2 with a damp cloth, both on a weekly basis. Remove the air filter cap occasionally (Fig. M) and clean it with soapy water. Prior to reinstallation, make sure that the air filter cap has fully dried.

Regularly inspect the fuel filter as well:

- 1 Remove the removable tank 7 from the heater and remove the fuel filter (Fig. N). Some drops may leak from the filter; keep a cloth at hand.
- 2 Remove the dirt by tapping the fuel filter upside-down against a hard surface. **(Never clean it with water!)**
- 3 Reinstall the fuel filter into the heater.

We recommend that you remove dust and stains in time with a damp cloth, because otherwise these may cause stains that are hard to remove.



Do not remove any heater components yourself. Always contact your Zibro dealer for repairs. When the power cord is damaged, it may only be replaced by an authorised fitter. Use a new cord of the type H05 VV-F.

N STORAGE (END OF THE HEATING SEASON)

At the end of the heating season, you must store the heater in a dust-free place, if possible in its original packaging. Unused fuel cannot be used in the next heating season. We therefore recommend that you burn up all fuel. If there is still some fuel left, do not throw it away, but dispose of it in accordance with the local regulations for the disposal of domestic chemical waste.

Always start the new heating season with fresh fuel. When you start re-using the heater follow the instructions again (starting from section A and as specified).

O TRANSPORTATION

Take the following measures to avoid fuel leakage during the transportation of the heater:

- 1 Let the heater cool down.
- 2 Remove the removable tank 7 from the heater and remove the fuel filter (refer to Section M, Fig. N). Some drops may leak from the filter; keep a cloth at hand. Store the fuel filter and the removable tank outside the heater.
- 3 Place the transportation cap into the position of the fuel filter (Fig. O). Press it tight.
- 4 Always move the heater in an upright position.

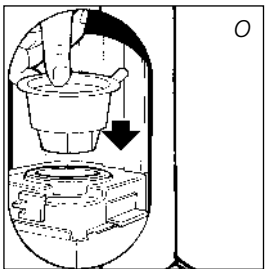

transportation cap

P SPECIFICATIONS

Ignition	electrical	Dimensions (mm)	width	460
Fuel	paraffin	(including base plate)	depth	300
Capacity (kW) max.	3.20		height	540
Capacity (kW) min.	0.80	Accessories	manual fuel pump	
Suitable space (m ³)**	50-130		fuel cap cover, transportation cap	
Fuel consumption (l/hr)*	0.333	Mains	230V	
Fuel consumption (g/hr)*	267		-- AC/50 Hz	
Burning time per tank (hr)*	15.9	Electrical consumption	igniter	320 W
Capacity removable tank (litres)	5.3		continuous 31 W	
Weight (kg)	11.0	Fuse rating	250V, 5A	

* At maximum setting ** Specified values are indicative

Q WARRANTY PROVISIONS

Your heater comes with a 24-month warranty starting on the date of purchase. Within this period all defects in material or workmanship will be repaired without any charge. The following provisions shall apply regarding this warranty:



- 1 We expressly dismiss all other claims for damages, including consequential damages.
- 2 Any repairs or replacements of components within the term of warranty will not result in an extension of the term of warranty.
- 3 The warranty shall no longer apply, when the heater has been modified, non-original parts have been used, or when it is repaired by third parties.
- 4 The warranty shall not apply to parts that are subject to normal wear, such as the burner mat and the manual fuel pump.
- 5 The warranty shall only apply, when you present the original, dated proof of purchase, provided no changes have been made to it.
- 6 The warranty shall not apply to damages caused by actions not in compliance with the Directions for Use, neglect, and the use of an incorrect type of fuel, or fuel past its use-by date. The use of incorrect fuel can even be dangerous*.
- 7 Transportation costs and the risks involved during the transportation of the heater or heater components shall always be for the account of the purchaser.

In order to avoid unnecessary costs, we recommend that you always read the 'Directions for Use' carefully first. In case they offer no solution, please take the heater to your dealer for repair.

* Highly inflammable substances may induce uncontrollable burning, causing flames to break out. Should this happen, never try to move the heater, but always switch off the heater immediately. In case of emergency you may use a fire extinguisher, but only a type B extinguisher: a carbon dioxide or powder extinguisher.

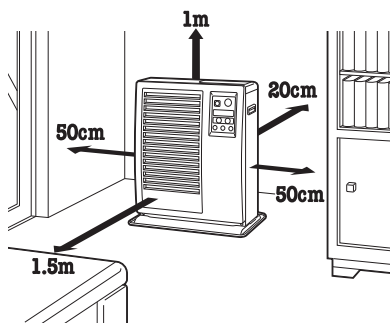

10 TIPS FOR SAFE USE

- 1 Make sure that children are always aware of the presence of a burning heater.
- 2 Do not move the heater when it is burning or still hot. Do not refill nor service the heater when it is burning or still hot.
- 3 Position the front of the heater at a distance of minimum 1.5 metres from walls, curtains, and furniture.
- 4 Do not use the heater in dusty rooms. You will not have optimum burning in such rooms. Do not use the heater in the immediate surrounding of a bath, a shower or a swimmingpool.
- 5 Switch off the heater, before you leave or go sleeping. Unplug the heater as well, when you go away for a longer period of time (e.g. holidays).
- 6 Store and move fuel only in suitable tanks and jerrycans.
- 7 Make sure that the fuel is not exposed to heat or extreme temperature changes. Always store the fuel in a cool, dry and dark place (sunlight will affect the quality).
- 8 Never use the heater in places where harmful gasses or fumes may be present (e.g. exhaust gasses or paint fumes).
- 9 Beware that the grid of the heater becomes hot. If the appliance is covered there is a risk of fire.
- 10 Always make sure that there is sufficient ventilation.



Defective electrical devices and batteries must be kept separate from household waste. Ensure that there is effective recycling where possible. Ask you local council or dealer for expert advice on recycling.



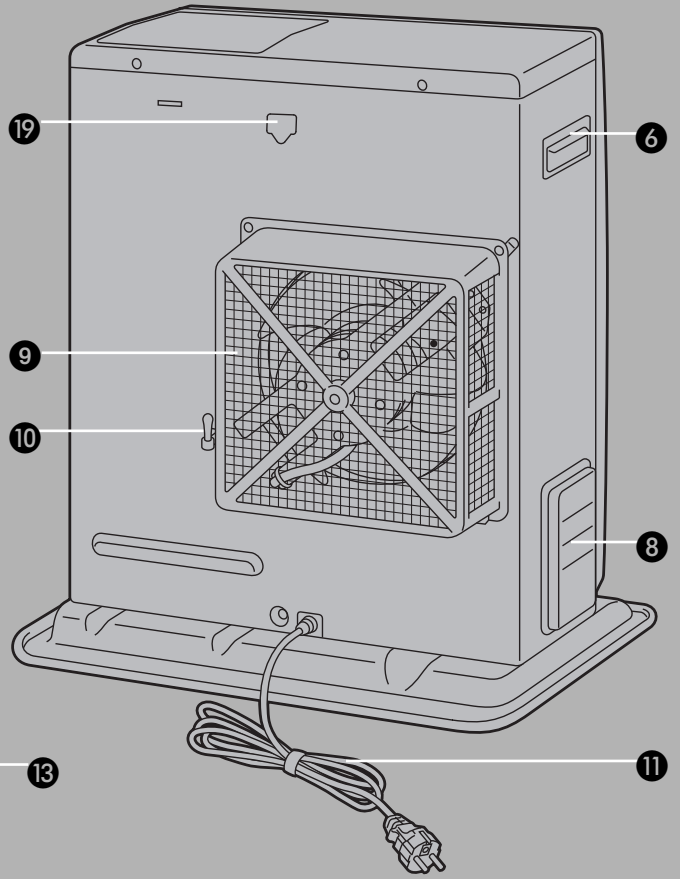
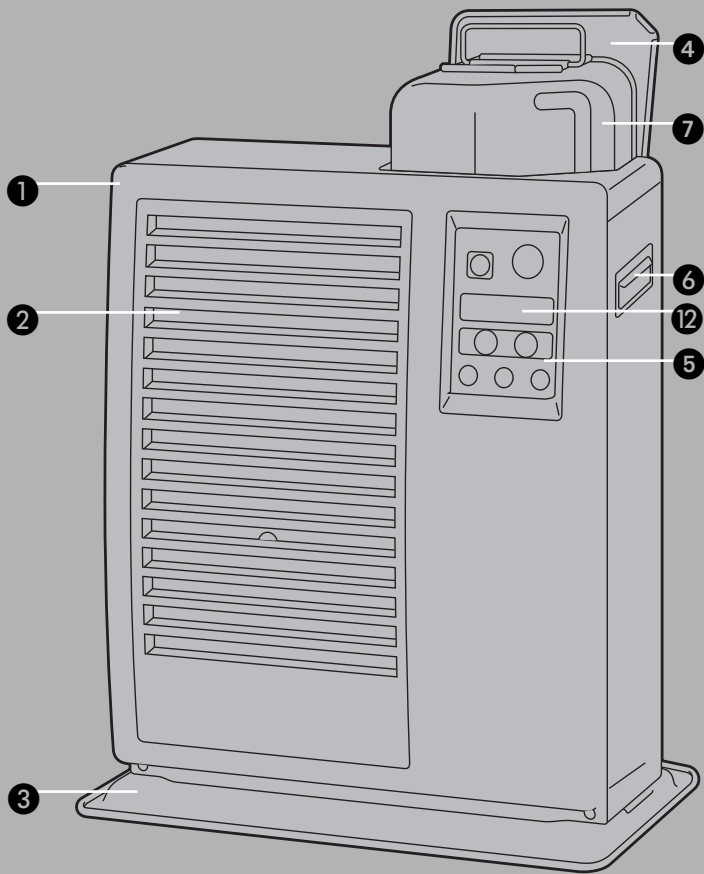

DISTRIBUTED IN EUROPE BY PVG INTERNATIONAL b.v.

A ÖSTERREICH

PVG Austria VertriebsgmbH
Salaberg 49
3350 HAAG
tel: +43 7434 44867
fax: +43 7434 44868
email: pvgaustria@zibro.com

B BELGIË

PVG Belgium NV/SA
Industrielaan 55
2900 SCHOTEN
tel: +32 3 326 39 39
fax: +32 3 326 26 39
email: pvgbelgium@zibro.com

CH SCHWEIZ

PVG Schweiz AG
Salinenstrasse 63
4133 PRATTELN
tel: +41 61 337 26 51
fax: +41 61 337 26 78
email: pvgint@zibro.com

D DEUTSCHLAND

PVG Deutschland GmbH
Siemensstrasse 31
47533 KLEVE
tel: 0800 - 9427646
fax: +31 (0)412 648 385
email: pvgdeutschland@zibro.com

DK DANMARK

Appliance A/S
Blavstrod Teglvaerksvej 3
DK-3450 ALLEROED
tel: +45 70 205 701
fax: +45 70 208 701
email: appliance@appliance-group.com

E ESPAÑA

PVG España S.A.
Pol. Ind. San José de Valderas II
Comunidad "La Alameda"
C/ Aurora Boreal, 19
28918 LEGANÉS (Madrid)
tel: +34 91 611 31 13
fax: +34 91 612 73 04
email: pvgspain@zibro.com

F FRANCE

PVG France SARL
4, Rue Jean Sibélius
B.P. 185
76410 SOTTEVILLE SOUS LE VAL
tel: +33 2 32 96 07 47
fax: +33 0 820 34 64 84
email: pvgfrance@zibro.com

FIN SUOMI

Appliance Finland Oy
Piispantilankuja 6C
02240 ESPOO
tel: +358 9 4390 030
fax: +358 9 4390 0320
email: appliance@appliance-group.com

GB UNITED KINGDOM

Scott Brothers Ltd.
The Old Barn, Holly House Estate
Crnage, Middlewich, CW10 9LT UK
tel.: +44 1606 837787
fax: +44 1606 837757
email: sales@scottmail.co.uk

I ITALIA

PVG Italy SRL
Via Niccolò Copernico 5
50051 CASTELFIORENTINO (FI)
tel: +39 571 628 500
fax: +39 571 628 504
email: pvgitaly@zibro.com

N NORGE

Appliance Norge AS
Vogellunden 31
1394 NESBRU
tel: +47 667 76 200
fax: +47 667 76 201
email: appliance@appliance-group.com

NL NEDERLAND

PVG International B.V.
P.O. Box 96
5340 AB OSS
tel: +31 412 694 694
fax: +31 412 622 893
email: pvgnl@zibro.com

P PORTUGAL

Gardena, Lda
Recta da Granja do Marquês
ALGUEIRÃO
2725-596 MEM MARTINS
tel: + 35 21 92 28 530
fax: + 35 21 92 28 536
email: pvgint@zibro.com

PL POLSKA

PVG Polska Sp. z. o. o.
ul. Kościelna 110
26-800 Białobrzegi
tel: +48 48 613 00 70
fax: +48 48 613 00 70
email: pvgpoland@zibro.com

S SVERIGE

Appliance Sweden AB
Sjögatan 6
25225 HELSINGBORG
tel: +46 42 287 830
fax: +46 42 145 890
email: appliance@appliance-group.com

TR TURKEY

PVG Isıtma Klima Soğutma Ltd.Şti.
Atatürk Cad. No 380 Ak İşhani Kat 6
35220 Alsancak
IZMIR - TURKEY
tel: + 90 232 463 33 72
fax: + 90 232 463 69 91
email: pvgturkey@zibro.com