



user manual
notice d'utilisation

Tumble Dryer
Séchoir à condensation

EDC 46130 W



We were thinking of you
when we made this product

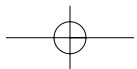

Welcome to the world of Electrolux

Thank you for choosing a first class product from Electrolux, which hopefully will provide you with lots of pleasure in the future. The Electrolux ambition is to offer a wide variety of quality products that make your life more comfortable. You find some examples on the cover in this manual. Please take a few minutes to study this manual so that you can take advantage of the benefits of your new machine. We promise that it will provide a superior User Experience delivering Ease-of-Mind. Good luck!

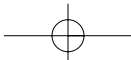

4 contents electrolux

Contents

Safety information.....	5
Product description	7
Control panel.....	7
Use.....	8
Drying hints	12-13
Drying programme.....	14
Care and cleaning	15-17
Something not working	18-19
Technical data	20
Consumption values	21
Installation	22-23
Environment concerns.....	24
Guarantee conditions	25-26
Customer service	26

The following symbols are used in this manual:



Important information concerning your personal safety and information on how to avoid damaging the appliance.



General information and tips



Environmental information

Safety Information



In the interest of your safety and to ensure the correct use, before installing and first using the appliance, read this user manual carefully, including its hints and warnings. To avoid unnecessary mistakes and accidents, it is important to ensure that all people using the appliance are thoroughly familiar with its operation and safety features. Save these instructions and make sure that they remain with the appliance if it is moved or sold, so that everyone using it through its life will be properly informed on appliance use and safety.

General safety

- It is dangerous to alter the specifications or attempt to modify this product in any way.
- Make sure that small pets do not climb into the drum. To avoid this, please check into the drum before using.
- Any objects such as coins, safety pins, nails, screws, stones or any other hard, sharp material can cause extensive damage and must not be placed into the machine.
- As some bulky items such as duvets and eiderdowns should be dried in large commercial machines because of their bulk, check with the manufacturer of the item if it is suitable for drying in a domestic machine, even if the dry weight of the item is within the limit advised.
- In order to avoid danger of fires caused by excessive drying, do not

use appliance to dry the following items: Cushions, quilts and the like (these items accumulate heat).

Items containing rubber foam or materials similar to rubber foam.

- Always unplug the appliance after use, clean and maintenance.
- Under no circumstances should you attempt to repair the machine yourself. Repairs carried out by inexperienced persons may cause injury or serious malfunctioning. Contact your local Service Centre. Always insist on genuine spare parts.
- **Danger of explosion:** Never tumble dry items that have been in contact with inflammable solvents (petrol, methylated spirits, dry cleaning fluid and the like). As these substance are volatile, they could cause an explosion. Only tumble dry items washed with water.
- **Risk of fire:** items that have been spotted or soaked with vegetable or cooking oil constitute a fire hazard and should not be placed in the tumble dryer.
- If you have washed your laundry with stain remover you must execute an extra rinse cycle before loading your tumble dryer.
- Please make sure that no gas lighters or matches have accidentally been left in pockets of garments to be loaded into appliance

Installation

- This appliance is heavy. Care should be taken when moving it.
- When unpacking the appliance, check that it is not damaged. If in doubt, do not use it and contact the Service Centre.
- All packing and transit bolts must be

6 safety information electrolux

removed before use. Serious damage can occur to the product and to property if this is not adhered to. See relevant section in the user manual.

- The final part of a tumble dryer cycle occurs without heat (cool down cycle) to ensure that the items are left at a temperature that ensures that items will not be damaged.
- Any electrical work required to install this appliance should be carried out by a qualified electrician or competent person.
- Care must be taken to ensure that the appliance does not stand on the electrical supply cable.
- If the machine is situated on a carpeted floor, please adjust the feet in order to allow air to circulate freely
- After having installed the appliance, check that it is not pressing or standing on its electrical supply cable, inlet hose and drain hose.
- If the tumble dryer is placed on top of a washing machine, it is compulsory to use the stacking kit (optional accessory).

Use

- This appliance is designed for domestic use. It must not be used for purposes other than those for which it was designed.
- Only wash fabrics which are designed to be machine dried. Follow the instructions on each garment label.
- Fabric softeners, or similar products, should be used as specified by the fabric softener instructions.
- Do not overload the appliance. See the relevant section in the user manual.

- Clothes which are dripping wet should not be placed in the dryer.
- Garments which have been in contact with volatile petroleum products should not be machine dried. If volatile cleaning fluids are used, care should be taken to ensure that the fluid is removed from the garment before placing in the machine.
- Never pull the power supply cable to remove the plug from the socket; always take hold of the plug itself.
- Never use the tumble dryer if the power supply cable, the control panel, the working surface or the base are damaged so that the inside of the tumble dryer is accessible.

WARNING:

Never stop a tumble dry before the end of the drying cycle unless all items are quickly removed and spread out so that the heat is dissipated.

Child safety

- This machine is not intended for use by young children or infirm persons without supervision.
- Young children should be supervised to ensure that they do not play with the appliance.
- The packaging components (e.g. plastic film, polystyrene) can be dangerous to children - danger of suffocation! Keep them out of children's reach
- Keep all detergents in a safe place out of children's reach.
- Make sure that children or pets do not climb into the drum.

Product description

- 1** Control panel
- 2** Fluff filters
- 3** Rating Plate
- 4** Condenser unit
- 5** Water reservoir
- 6** Adjustable feet

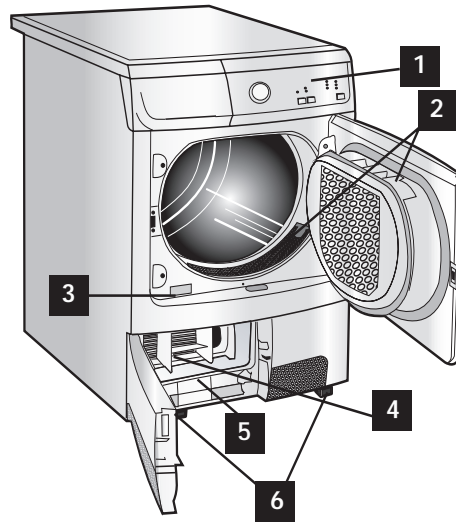

GB

Control panel

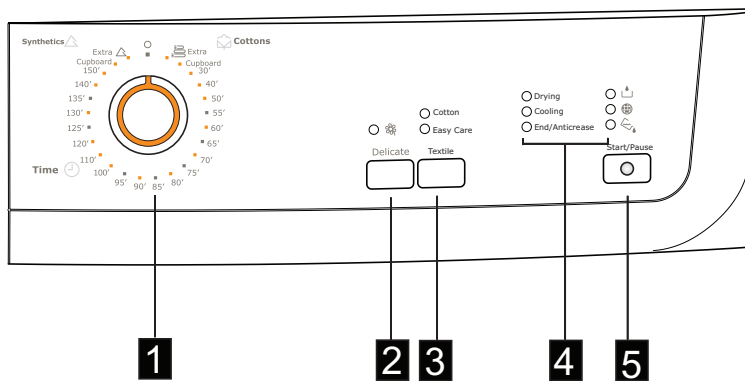

- 1** Programme selector dial
- 2** Delicate button 
- 3** Textile button
- 4** Indicator lights
- 5** Start/Pause button

8 use electrolux

Use

First Use



Ensure that the electrical connections comply with the installation instructions.

- Remove the polystyrene block and any material from the drum.
- Before using your tumble dryer for the first time, we commend that you to place a few damp cloths inside the appliance and dry for 30 minutes.

There may be dust inside a brand new tumble dryer.

caught between the door and filter.

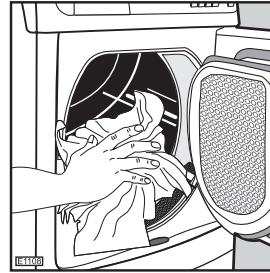

Select the required programme

Turn the programme selector dial to the required programme.

The light Start/Pause starts to flash.

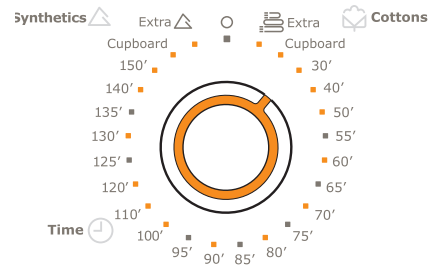

Daily Use

Load the laundry



Connect the appliance.
Open the door (see picture).



Place the laundry in the drum, one item at a time, shaking them out as much as possible. Close the door.

Please check the laundry does not get

The selector dial is divided into following sections:

Cottons

Synthetic

Time

Allows you to select electronically controlled or time controlled drying.

Turn the dial to the required programme or time.

Electronically controlled drying (automatic)

The appliance runs these programmes with the help of probes which detect the degree of dampness of the laundry. Simply select the programme according to the type of laundry and degree of drying required.

The selector dial can be turned either clockwise or anticlockwise. The lights

Drying, Cooling and End/Anticrease come on.

At the end of the programme the selector dial must be turned to position O, to switch the machine off.

Attention!

If you turn the programme selector dial to another programme when the machine is working, the lights of the programme progress display start to flash. The machine will not perform the new selected programme.

Programme Option buttons

Depending on the programme, different functions can be combined. These must be selected after choosing the desired programme and before depressing the Start/Pause button.

When these buttons are pressed, the corresponding pilot lights come on. When they are pressed again, the pilot lights go out.

Select Delicate

Pressing this button allows drying to be performed at a lower temperature, for delicate items.



The corresponding pilot light comes on. This option can also be used for time controlled drying. DELICATE is only suitable for use with loads of up to 3kg!

When the programme has finished the pilot lights End is on.

Select the Textile

Press the Textile button repeatedly, to select the desired option. The relevant light will light up.

- Cotton
- Easy Care



You can select 2 different options:

Cotton Cycle: to be used for cotton, where as in the programmes

When the programme has finished the pilot lights End is on.

Easy Care: to be used for synthetic or delicate items.

When the programme has finished the pilot lights End is on.

Select the Start/Pause

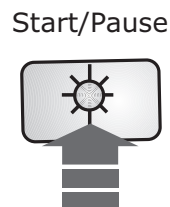

Press this button to start the dryer after having selected the programme and the options.

The relevant light will stop flashing. If the programme selector dial is turned to another position, when the machine is running, the buzzer will sound and the programme phase indicator lights will flash.

10 electrolux use

The drum turns alternately in both directions during drying.

All drying programmes end with a 10 minute cooling phase (light Cooling is on). You may remove the laundry after this phase.

The lights End/Anticrease and  illuminate and the buzzer sounds

If the door of the appliance or the small door at the bottom is opened while the programme is running, this button must be pressed again after closing the door in order to restart the programme from the point at which it was interrupted. This button must be depressed also after a power failure and after having re-inserted the water reservoir, if it has been emptied in the middle of a programme after lighting up of light .

In both cases the light of the Start/Pause button flashes to remind you that the start button needs to be pressed again.

Indicator lights

These lights indicate the following functions:

“Drying” light

This light indicates that the appliance is in the drying phase.

“Cooling” light

This light indicates that the appliance is in the cooling phase. At the end of drying, there is a 10 minute cooling phase to cool the laundry.

“End of programme” light

This light is on at the end of the cooling phase, during the anti-creasing phase and at the end of the programme.

“Water reservoir full” light

This light indicates that the appliance is in the drying phase.

This light comes on at the end of the programme to remind you that the

water reservoir must be emptied out. If this light illuminates during a programme this means that the water reservoir is full. The buzzer sounds, the programme stops, the light of the Start/Pause button flashes. This light comes on also when the water reservoir is not inserted correctly.

“Filter cleaning” light



This light illuminates at the end of the programme to remind you that the filters must be cleaned.

“Condenser cleaning” light



It comes on every 80 cycles to remind you that the condenser must be cleaned.

At the end of the programme

All drying programmes end with a 10 minute cooling phase.

You may remove the laundry after this phase. The lights **End of programme**,  and , and illuminate.

The display shows a static zero.

If the laundry is not removed at the end of the cycle, the dryer performs an **anti-creasing** phase (duration: 30 minutes maximum). If you do not remove the laundry, the dryer will stop automatically at the end of the anti-creasing phase. Lights **End of programme**,  and , remain lit and the buzzer sounds for 2 minutes.

Turn the programme selector dial to **“O”** to switch the machine off. Remove the laundry from the drum and carefully check that the drum is empty.

If you do not intend to carry out another wash, close the water tap. Leave the door open to prevent the formation of mildew and unpleasant smells.

Turn the programme selector dial to "O"; all the lights go out. The appliance is switched off.



Remove the laundry.

If you open and then close the door before turning the selector dial to "O" all the lights corresponding to the phases making up the performed programme come on.

After each use

- Clean the filters.
- Empty the water reservoir.

Important!

If the drying programme has to be stopped before it reaches the end, we recommend that you turn the programme selector dial to position Cooling  and wait until the end of this cooling phase before removing the laundry. This will avoid a build-up of heat inside the appliance. To do this first turn the dial to "O" and then to Cooling  and depress Start button.

Modifying the programme

To change a programme which is running, first cancel it by turning the programme selector dial to "O". Select the new programme and press the Start button .

Drying hints



Before loading the laundry

Never tumble dry the following:

Particularly delicate items such as net curtains, woollen, silk, fabrics with metal trim, nylon tights, bulky materials such as anoraks, blankets, eiderdowns, sleeping bags, feather quilts and any items containing rubber foam or materials similar to rubber foam.

- Always follow the instructions on garment labels:



may be tumble dried



normal drying (high temperature)



delicate drying (low temperature)



do not tumble dry

- Close pillowcases and covers with fasteners to prevent small laundry items getting tangled inside them. Close press studs, zips and hooks and tie belts and apron strings.
- Sort laundry according to type and degree of drying required.
- Do not over-dry laundry, this avoids creasing and saves energy.
- Avoid drying dark clothes with light coloured fluffy items such as towels as they could attract the fluff.
- The laundry must be thoroughly spun before tumble drying.
- **Easy-care items**, too, e.g. shirts, should be briefly pre-spun before

drying (depending on crease resistance approx. 30 seconds or using the special brief spin programme of your washing machine).

- Knitted textiles (knitted underwear) may shrink a little during drying. Please do not overdry items of this type. It is advisable to allow for shrinkage when choosing the size of new purchases.
- You can also put starched items into your dryer. However, to achieve the desired starched effect, choose the programme "iron dry". To remove any starch residues, wipe out the internal drum after drying with a moist cloth and then rub it dry.
- To avoid a static charge when drying is completed, use either a fabric softener when you are washing the laundry or a fabric conditioner specifically for tumble dryers.
- Remove the laundry when the dryer has finished drying.
- If individual items are still damp after drying, set a brief post-drying time, but **at least 30 minutes**. This will be necessary particularly for multilayered items (e.g. collars, pockets, etc.).

Make sure that no metal objects are left in the laundry (e.g. hair clips, safety pins, pins).

Button up pillowcases, close zip fasteners, hooks and poppers. Tie any belts or long tapes.

To avoid laundry becoming tangled: close zips, button up duvet covers and tie loose ties or ribbons (e.g. of aprons).

Turn items with double-layered fabrics inside out (e.g. with cottonlined anoraks, the cotton layer should be outermost). These fabrics will then dry better.

Maximum loads

Recommended loads are indicated in the programme charts.

General rules:

Cotton, linen: drum full but not too tightly packed;

Synthetics: drum no more than half full;

Delicate fabrics and woollens: drum no more than one third full.

Try to load to the maximum capacity of the machine as small loads are uneconomical.









Laundry weights

The following weights are indicative:

bathrobe	1200 g
napkin	100 g
quilt cover	700 g
sheet	500 g
pillow case	200 g
tablecloth	250 g
towelling towel	200 g
tea cloth	100 g
night dress	200 g
ladies' briefs	100 g
man's work shirt	600 g
man's shirt	200 g
man's pyjamas	500 g
blouse	100 g
men's underpants	100 g

14 electrolux drying programmes

Drying programmes

Programme	Type of laundry	Options	Description of programme
 Extra	Cotton 	Textile - Cotton	Drying thick or multi-layered textiles, e.g. terry towelling items
Cupboard	Cotton 	Textile - Cotton	Thorough drying of fabrics of even thicknesses, e.g. terry towelling items, knitted items, towels.
 Extra	Synthetics 	Textile - Easy care	Thorough drying of thick or multilayered fabrics, e.g. pullovers, bedding, table linen.
Cupboard	Synthetics 	Textile - Easy care	For thin fabrics which are not ironed, e.g. easy care shirts, table linen, baby clothes, socks, lingerie with bones or wires.
 Time	Synthetics 	Textile -Easy care -Cotton Delicate	If the TIME programme has been selected, programme duration time of 30 minutes up to 150 minutes can be set by intervals of 5 minutes or 10 minutes. Drying thick or multi-layered textiles, e.g. terry towelling items.



Max Cottons load: 6 kg
 Max Synthetics load: 3 kg
 Max Time load: 1 kg

Care and cleaning



You must **DISCONNECT** the appliance from the electricity supply, before you can carry out any cleaning or maintenance work.

External cleaning

Use only soap and water and then dry thoroughly.

Important: do not use methylated spirit, diluents or similar products..

Cleaning the door

Clean periodically the interior part of the door to remove any fluff from the seals around the filter. Accurate cleaning ensures correct drying.



Cleaning the filters

Your dryer will only function well if the filters are clean.

The filters collect all the fluff which accumulates during drying and they must therefore be cleaned **at the end of each programme**, before removing the laundry, with a damp cloth. The light  is on to remind you this operation.

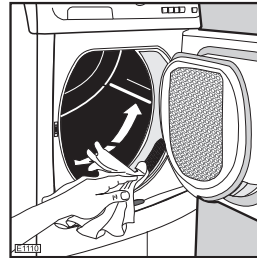

The filter in the inner door must be removed for cleaning.

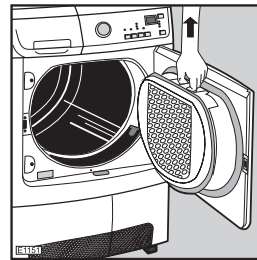

Do not be alarmed by the amount of fluff. It is not due to excessive wear caused by the dryer.

All fabric loses fluff when drying but it goes un-noticed in the air. In a tumble dryer it simply collects in the filter.

After a while, a whitish patina due to detergent residue on laundry forms on the filters. When this occurs, clean the filters with warm water using a brush. Remove the filter in the door opening as per picture (it can be positioned with the tooth facing to the left or to the right).



16 electrolux care and cleaning



Do not use the appliance without filters.

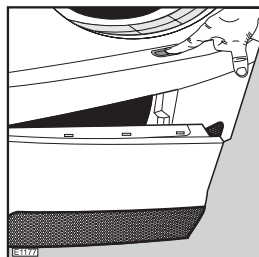

Cleaning the condenser unit

Clean the condenser when light  comes on.

The condenser is situated at the lower part of the cabinet behind a small door. To open the door, push the catch as per picture.

During the drying cycle or at the end, it is normal for water to be present on the surface of the condenser insertion.

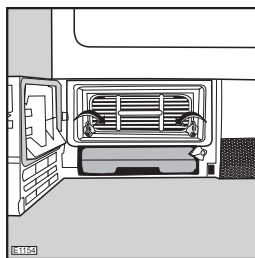

To pull out the condenser, first turn the two red stops downwards and then remove the condenser unit holding it at the handle.

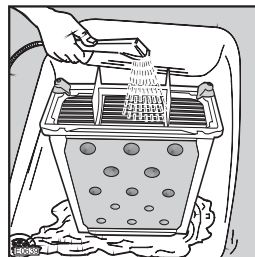
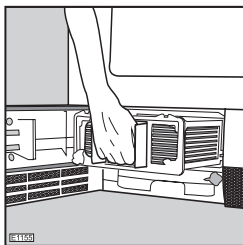

Clean it with a brush and rinse it under the shower if necessary.

Also clean the outside, removing all fluff.

Clean the rubber seal round the condenser cabinet and in the inner part of the small door with a damp cloth.



Important! Do not use pointed objects or utensils to clean the spaces between the plates, as this could damage the condenser and make it permeable.

Re-fit the condenser, turn the red stops upwards and close the door.



Do not use this appliance if the condenser has not been fitted.

Emptying the water reservoir

Water extracted from the laundry condenses inside the machine and is collected in a reservoir.

The reservoir must be emptied **after each drying cycle** to ensure efficient operation when the machine is next used. The pilot

light  reminds you this operation.

Proceed as follows:

- Open the small door at the lower part of the cabinet
- Turn the yellow stop upwards
- Pull out the reservoir
- Open the small cover and let water flow down
- Close the small cover and re-insert correctly the reservoir
- Push it until it clicks and turn the yellow stop downwards to lock firmly it
- Close the small door and press the START/PAUSE button again to allow the programme to continue.

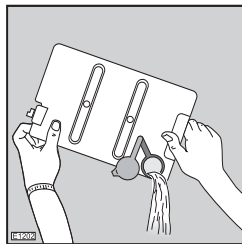
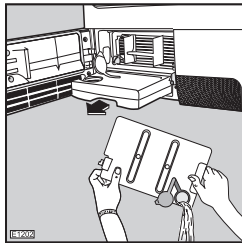

The reservoir must be re-inserted correctly.

After emptying and inserting the reservoir the START-button has to be depressed again to allow the programme to continue.

Handy tip: The condensed water may be used in a steam iron or to top up a battery, etc. In this case it must be filtered (e.g. through a coffee filter).

Cleaning the air intake grille

Using a vacuum cleaner remove the fluff from the air intake grille at the back of the appliance.

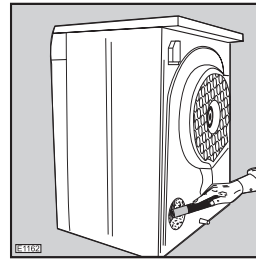

Cleaning the drum

When your laundry does not reach the desired degree of dryness, in other words, when it turns out either too dry or too damp, we advise you to clean the inside of the drum with a cloth soaked with vinegar.

This will eliminate the slight patina that has formed in the drum (due to residues of detergent and softeners used in the washing, and to the lime contained in the water), which prevents the probes from detecting the correct degree of dryness.

18 electrolux something not working

Something not working

Certain problems are due to lack of simple maintenance or oversights, which can be solved easily without calling out an engineer. Before contacting your local Service Centre, please carry out the checks listed below.

During machine operation it is possible that the **red** Start/Pause pilot light flashes to indicate that the machine is not working.

Once the problem has been eliminated, press the **Start/Pause** button to restart the programme. If after all checks, the problem persists, contact your local Service Centre.

Malfunction	Possible cause	Solution
Dryer does not work.	<ul style="list-style-type: none"> ● Mains plug is not plugged in or fuse is not working correctly. ● Loading door is open. ● Have you pressed the START/ PAUSE button? 	<ul style="list-style-type: none"> ● Plug in at mains socket. Check fuse in fuse box (domestic installation). ● Close loading door. ● Press the START/PAUSE button again.
Drying results unsatisfactory.	<ul style="list-style-type: none"> ● Wrong programme selected. ● Lint filter clogged. ● Heat exchanger clogged with lint. ● Incorrect volume of laundry. ● Ventilation slots in base area covered up. ● Residue on inside surface of drum or drum ribs. ● Conductance of water at installation site differs from standard setting of machine. 	<ul style="list-style-type: none"> ● Select a different programme the next time you dry (see "Overview of programmes" section). ● Clean lint filter. ● Clean heat exchanger. ● Observe recommended loading volumes. ● Uncover ventilation slots in base area. ● Clean inside surface of drum and drum ribs ● Re-programme standard setting for degree of drying (see 'Programming options' section).
Loading door does not close.	<ul style="list-style-type: none"> ● Fine strainer not in place and/or large mesh filter not locked in place. 	<ul style="list-style-type: none"> ● Install fine strainer and/or snap large mesh filter into place.

Malfunction	Possible cause	Solution
When pressing a button, the corresponding button flashes several times.	<ul style="list-style-type: none"> Washing protection. After the start of the programme, the option can no longer be set. 	<ul style="list-style-type: none"> Turn the programme knob to OFF. Set the programme again
Drying cycle ends shortly after programme starts. END light illuminated.	<ul style="list-style-type: none"> Not enough washing loaded or washing loaded is too dry for selected programme. 	<ul style="list-style-type: none"> Select time programme or higher drying level (e.g. EXTRA DRY instead of CUPBOARD).
Programme inactive, Water reservoir full light illuminated.:	<ul style="list-style-type: none"> Condensate tank is full. 	<ul style="list-style-type: none"> Empty condensate tank, then start programme with START/PAUSE button.
Drying cycle lasts an unusually long time. Note: After around 5 hours the drying cycle ends automatically (see „Drying cycle complete“)	<ul style="list-style-type: none"> Lint filter clogged. Heat exchanger clogged with lint. DELICATE button pressed and load volume too big. Load volume too big. Laundry insufficiently predrained. 	<ul style="list-style-type: none"> Clean lint filter Clean heat exchanger. DELICATE is only suitable for use with loads of up to 3 kg! Reduce load volume. Laundry must be adequately pre-drained.

GB



If you are unable to identify or solve the problem, contact our service centre. Before telephoning, make a note of the model, serial number and purchase date of your machine: the Service Centre will require this information.

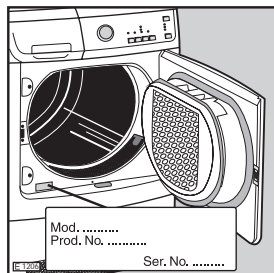

IMPORTANT: if you call out an engineer to a fault listed below, or to repair a fault caused by incorrect use or installation, a charge will be made even if the appliance is under guarantee.

20 electrolux technical data

Technical data

Dimensions	Width	60 cm
	Height	85 cm
	Depth	58 cm
Electrical connection Voltage - Overall power - Fuse	Information on the electrical connection is given on the rating plate on the inner edge of the appliance door	
Depth with loading door open		109 cm
Maximum Load	Cotton	6 kg
	Synthetics	3 kg
Use	Domestic + 5°C à + 35°C	

 This appliance conforms with the following EU Directives:
 73/23/EEC dated 19.02.1973 Low Voltage Directive
 89/336/EEC dated 03.05.1989 EMC Directive inclusive of
 Amending Directive 92/31/EEC
 93/68/EEC dated 22.07.1993 CE Marking Directive

consumption values electrolux 21

Consumption values			
Programme	Programme duration (in minutes)	Energy consumption (in kWh)	Revolutions per minute
Cottons Cupboard ¹⁾	110	3.7	1000
Cottons Cupboard ¹⁾	95	3.0	1400
Synthetics Cupboard ²⁾	46	1.4	1200

GB



¹⁾ Max Cottons load: 6 kg
²⁾ Max Synthetics load: 3 kg



The consumption values have been established under standard conditions. They may deviate when the machine is operated in domestic circumstances.

22 electrolux installation

Installation

Unpacking



Slide out the polythene bag with the polystyrene stuffing before using the appliance. Pull off adhesive strips from inside machine on top of drum.

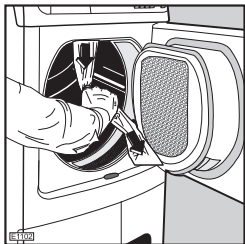

Should the appliance be moved, it must be transported vertically.



The appliance must not be installed behind a lockable door, a sliding door a door with a hinge on the opposite side to that of the appliance.

Positioning

It is recommended that, for your convenience, the machine is positioned close to your washing machine.

The tumble dryer must be installed in a clean place, where dirt does not build up.

Air must be able to circulate freely all round the appliance. Do not obstruct the front ventilation grille or the air intake grilles at the back of the machine.

To keep vibration and noise to a minimum when the dryer is in use, it should be placed on a firm, level surface.

Once in its permanent operating position, check that the dryer is absolutely level with the aid of a spirit level. If it is not, raise or lower the feet until it is.

The feet must never be removed. Do not restrict the floor clearance through deeppile carpets, strips of wood or similar. This might cause heat build-up which would interfere with the operation of the appliance.



Important

The hot air emitted by the tumble dryer can reach temperatures of up to 60°C. The appliance must therefore not be installed on floors which are not resistant to high temperatures.

When operating the tumble dryer, the room temperature must not be lower than +5°C and higher than +35°C, as it may affect the performance of the appliance.

Stacking kit

A special stacking kit is available through your dealer, to enable the mounting of the dryer on top of a front loading washing machine with cover's depth between 48 and 60 cm.

Read carefully the instructions supplied with the kit.

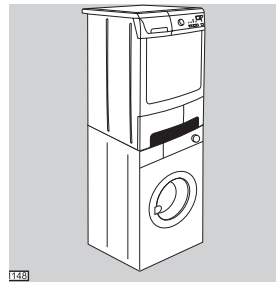

Door reversal

To make it easier to load or unload the laundry the door can be reversed.



Reversing the door is not possible if after this operation the appliance result installed behind a door with a hinge on the opposite side to that of the appliance.

This operation must be carried out by qualified personnel.

Please contact the nearest Service Centre.

Electrical connection

This machine is designed to operate on a 220-230 V,

single-phase, 50 Hz supply. Check that your domestic electrical installation can take the maximum load required (2.2 kW), also taking into account any other appliances in use.

Connect the machine to an earthed socket, in accordance with current wiring regulations.



The manufacturer declines any responsibility for damage or injury through failure to comply with the above safety precaution. Should the appliance power supply cable need to be replaced, this must be carried out by our Service Centre.



Important!

The power supply cable must be accessible after installing the machine.

24 electrolux environment concerns

Environment concerns

Packaging materials



The materials marked with the symbol  are recyclable.

>PE<=polyethylene

>PS<=polystyrene

>PP<=polypropylene

This means that they can be recycled by disposing of them properly in appropriate collection containers.

Old machine

Use authorised disposal sites for your old appliance. Help to keep your country tidy!



The symbol  on the product or on its packaging indicates that this product may not be treated as household waste. Instead it shall be handed over to the applicable collection point for the recycling of electrical and electronic equipment. By ensuring this product is disposed of correctly, you will help prevent potential negative consequences for the environment and human health, which could otherwise be caused by inappropriate waste handling of this product. For more detailed information about recycling of this product, please contact your local city office, your household waste disposal service or the shop where you purchased the product.

Ecological hints



To save energy and to help protect the environment, we recommend that you follow these hints:

- Try to load the maximum capacity of the machine as small loads are uneconomical.
- Always load well spun laundry. The higher the spinspeed, the lower the electricity consumption and the shorter the drying times.
- Do not over-dry laundry, this avoids creasing and saves energy. Select the drying programme according to the type of laundry and the required degree of dryness.
- To utilize the maximum load, laundry which is to be dried ready to put away (store dry) can be dried together with items to be ironed. To do this, select the programme for iron-dry, remove the iron-dry items at the end of the programme and then finish-dry the rest of the load.
- Clean the filters regularly to avoid excessive drying times and high electricity consumption.
- Ventilate the room well. The room temperature should not exceed +35°C during drying.

European guarantee

This appliance is guaranteed by Electrolux, in each of the countries listed in the following page, for the period specified in the appliance guarantee or otherwise by law. If you move from one of these countries to another of these countries the appliance guarantee will move with you subject to the following qualifications:

- The appliance guarantee starts from the date you first purchased the appliance which will be evidenced by production of a valid purchase document issued by seller of the appliance.
- The appliance guarantee is for the same period and to the same extent for labour and parts as exists in your country of residence for this particular model or range of appliances.
- The appliance guarantee is personal to the original purchaser of the appliance and cannot be transferred to another user.
- The appliance is installed and used in accordance with instructions issued by Electrolux and is only used within the home, i.e. is not used for commercial purposes.
- The appliance is installed in accordance with all relevant regulations in force within your new country of residence.

The provisions of this European Guarantee do not affect any of the rights granted to you by law.

Belgium

DECLARATION OF GUARANTEE TERMS.

Our appliances are produced with the greatest of care. However, a defect may still occur. Our

consumer services department will repair this upon request, either during or after the guarantee period. The service life of the appliance will not, however, be reduced as a result.

This declaration of guarantee terms is based on European Union Directive 99/44/EC and the provisions of the Civil Code. The statutory rights that the consumer has under this legislation are not affected by this declaration of guarantee terms. This declaration does not affect the vendor's statutory warranty to the end user. The appliance is guaranteed within the context of and in adherence with the following terms:

1. In accordance with provisions laid down in paragraphs 2 to 15, we will remedy free of charge any defect that occurs within 24 months from the date the appliance is delivered to the first end user. These guarantee terms do not apply in the event of use for professional or equivalent purposes.
2. Performing the guarantee means that the appliance is returned to the condition it was in before the defect occurred. Defective parts are replaced or repaired. Parts replaced free of charge become our property.
3. So as to avoid more severe damage, the defect must be brought to our attention immediately.
4. Applying the guarantee is subject to the consumer providing proof of purchase showing the purchase and/or delivery date.
5. The guarantee will not apply if damage caused to delicate parts, such as glass (vitreous ceramic), synthetic materials and rubber, is the result of inappropriate use.
6. The guarantee cannot be called on for minor faults that do not affect the value or the overall reliability of the appliance.
7. The statutory warranty does not apply when defects are caused by:
 - a chemical or electrochemical reaction caused by water,
 - abnormal environmental conditions in general,
 - unsuitable operating conditions,
 - contact with harsh substances.
8. The guarantee does not apply to defects due to transport which have occurred outside of our responsibility. Nor will the guarantee cover those caused by inadequate installation or assembly, lack of maintenance or failure to respect the assembly instructions or directions for use.
9. Defects that result from repairs or measures carried out by people who are not qualified or expert or defects that result from the addition of

GB

26 electrolux guarantee/customer service

non-original accessories or spare parts are not covered by the guarantee.

10. Appliances that are easy to transport may be delivered or sent to the consumer services department. Home repairs are only anticipated for bulky appliances or built-in appliances.

11. If the appliances are built-in, built-under, fixed or suspended in such a way that removing and replacing them in the place where they are fitted takes more than half an hour, the costs that result therefrom will be charged for. Connected damage caused by these removal and replacement operations will be the responsibility of the user.

12. If, during the guarantee period, repairing the same defect repeatedly is not conclusive, or if the repair costs are considered disproportionate, in agreement with the consumer, the defective appliance may be replaced with another appliance of the same value. In this event, we reserve the right to ask for a financial contribution calculated according to the length of time it has been used.

13. A repair under guarantee does not mean that the normal guarantee period will be extended nor that a new guarantee period begins.

14. We give a twelve month guarantee for repairs, limited to the same defect.

15. Except in the event where liability is legally imposed, this declaration of guarantee terms excludes any compensation for damage outside the appliance for which the consumer wishes to assert his rights. In the event of legally admitted liability, compensation will not exceed the purchase price paid for the appliance. These guarantee terms are only valid for appliances purchased and used in Belgium. For exported appliances, the user must first make sure that they satisfy the technical conditions (e.g.: voltage, frequency, installation instructions, type of gas, etc.) for the country concerned and that they can withstand the local climatic and environmental conditions.

For appliances purchased abroad, the user must first ensure that they meet the qualifications required in Belgium. Non-essential or requested adjustments are not covered by the guarantee and are not possible in all cases. Our consumer services department is always at your disposal, even after the guarantee period has expired.

Address for our consumer services department:**Belgium**

Electrolux Home	Consumer	02/	02/
Products Belgium	services	363.04.	363.04.0
		44	0
ELECTROLUX			02/
SERVICE			363.04.6
			0

Bergensesteenweg 719

1502 Lembeek

E-mail: consumer.services@electrolux.be

Luxembourg

Electrolux Home	Consumer	00352	00352
Luxembourg	services	42 431-	42 431-
		1	360

ELECTROLUX

HOME PRODUCTS

Rue de Bitbourg, 7

L-1273 Luxembourg- Hamm

E-mail: consumer-service.luxembourg@electrolux.