

**P5QL-VM DO**

**ASUS**<sup>®</sup>

**Motherboard**

E4726

First Edition V1

June 2009

**Copyright © 2009 ASUSTeK Computer Inc. All Rights Reserved.**

No part of this manual, including the products and software described in it, may be reproduced, transmitted, transcribed, stored in a retrieval system, or translated into any language in any form or by any means, except documentation kept by the purchaser for backup purposes, without the express written permission of ASUSTeK Computer Inc. ("ASUS").

Product warranty or service will not be extended if: (1) the product is repaired, modified or altered, unless such repair, modification or alteration is authorized in writing by ASUS; or (2) the serial number of the product is defaced or missing.

ASUS PROVIDES THIS MANUAL "AS IS" WITHOUT WARRANTY OF ANY KIND, EITHER EXPRESS OR IMPLIED, INCLUDING BUT NOT LIMITED TO THE IMPLIED WARRANTIES OR CONDITIONS OF MERCHANTABILITY OR FITNESS FOR A PARTICULAR PURPOSE. IN NO EVENT SHALL ASUS, ITS DIRECTORS, OFFICERS, EMPLOYEES OR AGENTS BE LIABLE FOR ANY INDIRECT, SPECIAL, INCIDENTAL, OR CONSEQUENTIAL DAMAGES (INCLUDING DAMAGES FOR LOSS OF PROFITS, LOSS OF BUSINESS, LOSS OF USE OR DATA, INTERRUPTION OF BUSINESS AND THE LIKE), EVEN IF ASUS HAS BEEN ADVISED OF THE POSSIBILITY OF SUCH DAMAGES ARISING FROM ANY DEFECT OR ERROR IN THIS MANUAL OR PRODUCT.

SPECIFICATIONS AND INFORMATION CONTAINED IN THIS MANUAL ARE FURNISHED FOR INFORMATIONAL USE ONLY, AND ARE SUBJECT TO CHANGE AT ANY TIME WITHOUT NOTICE, AND SHOULD NOT BE CONSTRUED AS A COMMITMENT BY ASUS. ASUS ASSUMES NO RESPONSIBILITY OR LIABILITY FOR ANY ERRORS OR INACCURACIES THAT MAY APPEAR IN THIS MANUAL, INCLUDING THE PRODUCTS AND SOFTWARE DESCRIBED IN IT.

Products and corporate names appearing in this manual may or may not be registered trademarks or copyrights of their respective companies, and are used only for identification or explanation and to the owners' benefit, without intent to infringe.

# Contents

Notices.....	v
Safety information .....	vi
About this guide .....	vii
P5QL-VM DO specifications summary .....	viii

## Chapter 1: Product introduction

<b>1.1</b>	<b>Before you proceed .....</b>	<b>1-1</b>
<b>1.2</b>	<b>Motherboard overview .....</b>	<b>1-2</b>
1.2.1	Motherboard layout .....	1-2
1.2.2	Layout contents.....	1-2
<b>1.3</b>	<b>Central Processing Unit (CPU) .....</b>	<b>1-3</b>
<b>1.4</b>	<b>System memory .....</b>	<b>1-3</b>
1.4.1	Overview .....	1-3
1.4.2	Memory configurations.....	1-4
<b>1.5</b>	<b>Expansion slots.....</b>	<b>1-8</b>
1.5.1	Installing an expansion card .....	1-8
1.5.2	Configuring an expansion card .....	1-8
1.5.3	PCI slots.....	1-8
1.5.4	PCI Express x16 slot.....	1-8
<b>1.6</b>	<b>Jumpers .....</b>	<b>1-9</b>
<b>1.7</b>	<b>Connectors .....</b>	<b>1-10</b>
1.7.1	Rear panel ports .....	1-10
1.7.2	Internal connectors .....	1-12
<b>1.8</b>	<b>Software support.....</b>	<b>1-18</b>
1.8.1	Installing an operating system .....	1-18
1.8.2	Support DVD information .....	1-18

## Chapter 2: BIOS information

<b>2.1</b>	<b>Managing and updating your BIOS .....</b>	<b>2-1</b>
2.1.1	ASUS Update utility .....	2-1
2.1.2	ASUS EZ Flash 2 utility.....	2-2
2.1.3	ASUS CrashFree BIOS 3 utility .....	2-3
<b>2.2</b>	<b>BIOS setup program .....</b>	<b>2-4</b>
<b>2.3</b>	<b>Main menu .....</b>	<b>2-4</b>

# Contents

- 2.3.1 System Time ..... 2-4
- 2.3.2 System Date ..... 2-4
- 2.3.3 SATA 1-6 ..... 2-5
- 2.3.4 Storage Configuration ..... 2-5
- 2.3.5 System Information ..... 2-6
- 2.4 Ai Tweaker menu ..... 2-6**
- 2.5 Advanced menu ..... 2-8**
  - 2.5.1 CPU Configuration ..... 2-8
  - 2.5.2 Chipset ..... 2-9
  - 2.5.3 Onboard Devices Configuration ..... 2-11
  - 2.5.4 USB Configuration ..... 2-12
  - 2.5.5 PCI PnP ..... 2-13
  - 2.5.6 TPM Configuration ..... 2-13
- 2.6 Power menu ..... 2-14**
  - 2.6.1 Suspend Mode ..... 2-14
  - 2.6.2 Repost Video on S3 Resume ..... 2-14
  - 2.6.3 ACPI 2.0 Support ..... 2-14
  - 2.6.4 ACPI APIC Support ..... 2-14
  - 2.6.5 APM Configuration ..... 2-14
  - 2.6.6 HW Monitor Configuration ..... 2-15
- 2.7 Boot menu ..... 2-16**
  - 2.7.1 Boot Device Priority ..... 2-16
  - 2.7.2 Boot Settings Configuration ..... 2-16
  - 2.7.3 Security ..... 2-17
- 2.8 Tools menu ..... 2-18**
  - ASUS EZ Flash 2 ..... 2-18
- 2.9 Exit menu ..... 2-18**

## Notices

### Federal Communications Commission Statement

This device complies with Part 15 of the FCC Rules. Operation is subject to the following two conditions:

- This device may not cause harmful interference, and
- This device must accept any interference received including interference that may cause undesired operation.

This equipment has been tested and found to comply with the limits for a Class B digital device, pursuant to Part 15 of the FCC Rules. These limits are designed to provide reasonable protection against harmful interference in a residential installation. This equipment generates, uses and can radiate radio frequency energy and, if not installed and used in accordance with manufacturer's instructions, may cause harmful interference to radio communications. However, there is no guarantee that interference will not occur in a particular installation. If this equipment does cause harmful interference to radio or television reception, which can be determined by turning the equipment off and on, the user is encouraged to try to correct the interference by one or more of the following measures:

- Reorient or relocate the receiving antenna.
- Increase the separation between the equipment and receiver.
- Connect the equipment to an outlet on a circuit different from that to which the receiver is connected.
- Consult the dealer or an experienced radio/TV technician for help.



---

The use of shielded cables for connection of the monitor to the graphics card is required to assure compliance with FCC regulations. Changes or modifications to this unit not expressly approved by the party responsible for compliance could void the user's authority to operate this equipment.

---

### Canadian Department of Communications Statement

This digital apparatus does not exceed the Class B limits for radio noise emissions from digital apparatus set out in the Radio Interference Regulations of the Canadian Department of Communications.

This class B digital apparatus complies with Canadian ICES-003.

### REACH

Complying with the REACH (Registration, Evaluation, Authorisation, and Restriction of Chemicals) regulatory framework, we published the chemical substances in our products at ASUS REACH website at <http://green.asus.com/english/REACH.htm>



---

**DO NOT** throw the motherboard in municipal waste. This product has been designed to enable proper reuse of parts and recycling. This symbol of the crossed out wheeled bin indicates that the product (electrical and electronic equipment) should not be placed in municipal waste. Check local regulations for disposal of electronic products.

---



---

**DO NOT** throw the mercury-containing button cell battery in municipal waste. This symbol of the crossed out wheeled bin indicates that the battery should not be placed in municipal waste.

---

# Safety information

## Electrical safety

- To prevent electric shock hazard, disconnect the power cable from the electric outlet before relocating the system.
- When adding or removing devices to or from the system, ensure that the power cables for the devices are unplugged before the signal cables are connected. If possible, disconnect all power cables from the existing system before you add a device.
- Before connecting or removing signal cables from the motherboard, ensure that all power cables are unplugged.
- Seek professional assistance before using an adapter or extension cord. These devices could interrupt the grounding circuit.
- Ensure that your power supply is set to the correct voltage in your area. If you are not sure about the voltage of the electrical outlet you are using, contact your local power company.
- If the power supply is broken, do not try to fix it by yourself. Contact a qualified service technician or your retailer.
- The optical S/PDIF is an optional component (may or may not be included in your motherboard) and is defined as a CLASS 1 LASER PRODUCT.



---

INVISIBLE LASER RADIATION, AVOID EXPOSURE TO BEAM.

---

- Never dispose of the battery in fire. It could explode and release harmful substances into the environment.
- Never dispose of the battery with your regular household waste. Take it to a hazardous material collection point.
- Never replace the battery with an incorrect battery type.



- 
- RISK OF EXPLOSION IF BATTERY IS REPLACED BY AN INCORRECT TYPE.
  - DISPOSE OF USED BATTERIES ACCORDING TO THE ABOVE BATTERY-RELATED INSTRUCTIONS.
- 

## Operation safety

- Before installing the motherboard and adding devices on it, carefully read all the manuals that came with the package.
- Before using the product, ensure that all cables are correctly connected and the power cables are not damaged. If you detect any damage, contact your dealer immediately.
- To avoid short circuits, keep paper clips, screws, and staples away from connectors, slots, sockets and circuitry.
- Avoid dust, humidity, and temperature extremes. Do not place the product in any area where it may become wet.



---

This motherboard should only be used in environments with ambient temperatures between 5°C (14°F) and 40°C (104°F).

---

- Place the product on a stable surface.
- If you encounter technical problems with the product, contact a qualified service technician or your retailer.

# About this guide

This user guide contains the information you need when installing and configuring the motherboard.

## How this guide is organized

This guide contains the following parts:

- **Chapter 1: Product introduction**  
This chapter describes the features of the motherboard and the new technology it supports.
- **Chapter 2: BIOS information**  
This chapter tells how to change system settings through the BIOS setup menus. Detailed descriptions of the BIOS parameters are also provided.

## Conventions used in this guide

To ensure that you perform certain tasks properly, take note of the following symbols used throughout this manual.



**DANGER/WARNING:** Information to prevent injury to yourself when trying to complete a task.



**CAUTION:** Information to prevent damage to the components when trying to complete a task.



**IMPORTANT:** Instructions that you **MUST** follow to complete a task.



**NOTE:** Tips and additional information to help you complete a task.

## Where to find more information

Refer to the following sources for additional information and for product and software updates.

### 1. ASUS websites

The ASUS website provides updated information on ASUS hardware and software products.

### 2. Optional documentation

Your product package may include optional documentation, such as warranty flyers, that may have been added by your dealer. These documents are not part of the standard package.

## Typography

### **Bold text**

Indicates a menu or an item to select.

### *Italics*

Used to emphasize a word or a phrase.

### <Key>

Keys enclosed in the less-than and greater-than sign means that you must press the enclosed key.

Example: <Enter> means that you must press the Enter or Return key.

### <Key1>+<Key2>+<Key3>

If you must press two or more keys simultaneously, the key names are linked with a plus sign (+).

Example: <Ctrl>+<Alt>+<D>

## P5QL-VM DO specifications summary

<b>CPU</b>	LGA775 socket for Intel® Core™2 Quad / Core™2 Extreme / Core™2 Duo / Pentium® dual-core / Celeron® dual-core / Celeron® processors Support Intel® 45nm Multi-core CPU
<b>Chipset</b>	Northbridge: Intel® B43 Southbridge: Intel® ICH10D
<b>Front Side Bus</b>	1333/1066/800 MHz
<b>Memory</b>	Dual-channel memory architecture 4 x 240-pin DIMM slots support unbuffered non-ECC DDR2 800/667 MHz memory module Supports up to 16GB system memory  ** Refer to <a href="http://www.asus.com">www.asus.com</a> for the latest Memory QVL (Qualified Vendors List). *** When you install a total memory of 4GB or more, Windows® 32-bit operating system may only recognize less than 3GB. Hence, a total installed memory of less than 3GB is recommended if you are using a Windows 32-bit operating system.
<b>Graphics</b>	Integrated Intel® X4500 HD D-SUB Max. resolution: 2048 x 1536 x32Bpp @75Hz DVI Max. resolution: 1920 x 1200 @60Hz
<b>Expansion slots</b>	1 x PCIe x 16 slot 3 x PCI slots
<b>Storage</b>	6 x Serial ATA 3Gb/s connectors
<b>Audio</b>	VIA VT 1705 High Definition Audio 6-channel CODEC Supports Jack-detect and Multi-streaming technology
<b>USB</b>	Supports up to 10 USB 2.0/1.1 ports (4 ports at mid-board, 6 ports at the back panel)
<b>LAN</b>	Intel® 82567LF Gigabit LAN Phy controller
<b>ASUS special features</b>	ASUS CrashFree BIOS 3 ASUS Q-Fan ASUS EZ Flash 2 ASUS MyLogo 2
<b>Back panel I/O ports</b>	1 x PS/2 Keyboard port 1 x PS/2 Mouse port 1 x COM port 1 x RJ45 port 1 x VGA port 1 x DVI port 1 x ME switch 6 x USB 2.0/1.1 ports 6-channel audio I/O ports

*(continued on the next page)*



## P5QL-VM DO specifications summary

<b>Internal I/O connectors</b>	2 x USB 2.0/1.1 connectors support additional 4 USB 2.0/1.1 ports 6 x SATA connectors 1 x LPT connector 1 x COM connector 1 x Chassis fan connector 1 x CPU fan connector 1 x Power fan connector 1 x High Definition front panel audio connector 1 x System panel connector 1 x CD audio-in connector 1 x Chassis intrusion connector 1 x TPM connector 1 x 24-pin EATX power connector 1 x 4-pin ATX 12V power connector
<b>BIOS</b>	2 x 16Mb Flash ROM, AMI BIOS, PnP, DMI2.0, WfM2.0, SM BIOS 2.5, ACPI2.0a
<b>Accessories</b>	2 x Serial ATA cables 1 x I/O shield 1 x Support DVD 1 x User Manual
<b>Support DVD</b>	Drivers ASUS Update ASUS PC Probe II Intel® IT Director Anti-Virus software (OEM version)
<b>Form Factor</b>	uATX form factor: 9.6 in x 9.0 in (24.4cm x 22.9cm)

\*Specifications are subject to change without notice.

# Chapter 1

## Product introduction

Thank you for buying an ASUS® P5QL-VM DO motherboard!

Before you start installing the motherboard, and hardware devices on it, check the items in your motherboard package. Refer to page ix for the list of accessories.



---

If any of the items is damaged or missing, contact your retailer.

---

### 1.1 Before you proceed

Take note of the following precautions before you install motherboard components or change any motherboard settings.



- Unplug the power cord from the wall socket before touching any component.
  - Before handling components, use a grounded wrist strap or touch a safely grounded object or a metal object, such as the power supply case, to avoid damaging them due to static electricity
  - Hold components by the edges to avoid touching the ICs on them.
  - Whenever you uninstall any component, place it on a grounded antistatic pad or in the bag that came with the component.
  - Before you install or remove any component, switch off the ATX power supply and detach its power cord. Failure to do so may cause severe damage to the motherboard, peripherals, or components.
- 

### Onboard LED

This motherboard comes with a standby power LED that lights up to indicate that the system is ON, in sleep mode, or in soft-off mode. This is a reminder that you must shut down the system and unplug the power cable before removing or plugging in any motherboard component. The illustration below shows the location of the onboard LED.

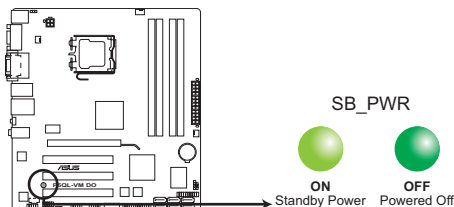

**P5QL-VM DO Onboard LED**

# 1.2 Motherboard overview

## 1.2.1 Motherboard layout



Ensure that you install the motherboard into the chassis in the correct orientation. The edge with external ports goes to the rear part of the chassis.

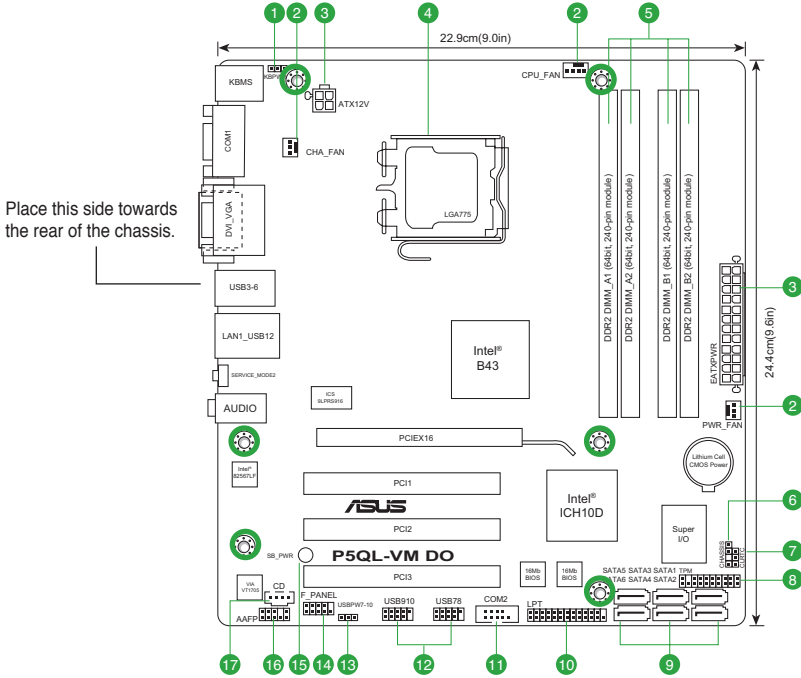

Place six screws into the holes indicated by circles to secure the motherboard to the chassis. DO NOT overtighten the screws! Doing so can damage the motherboard.

## 1.2.2 Layout contents

Connectors/Jumpers/Slots/LED	Page	Connectors/Jumpers/Slots/LED	Page
1. Keyboard power (3-pin KBPWR)	1-10	10. LPT connector (26-pin LPT)	1-15
2. CPU, Chassis, and Power fan connectors (4-pin CPU_FAN, 3-pin CHA_FAN, 3-pin PWR_FAN)	1-13	11. Serial port connectors (10-1 pin COM2)	1-17
3. ATX power connectors (24-pin EATXPWR, 4-pin ATX12V)	1-14	12. USB connectors (10-1 pin USB78, USB910)	1-13
4. Intel CPU socket	1-3	13. USB device wake-up (3-pin USBPW7-10)	1-10
5. DDR2 DIMM sockets	1-3	14. System panel connector (10-1 pin F_PANEL)	1-15
6. Chassis intrusion connector (4-1 pin CHASSIS)	1-16	15. Onboard LED	1-1
7. Clear RTC RAM (3-pin CLRRTC)	1-9	16. Front panel audio connector (10-1 pin AAFFP)	1-16
8. TPM connector (20-1 pin TPM)	1-17	17. Optical drive audio in connector (4-pin CD)	1-12
9. Serial ATA connectors (7-pin SATA1-6)	1-12		

## 1.3 Central Processing Unit (CPU)

This motherboard comes with a surface mount LGA775 socket designed for the Intel® Core™ 2 Quad / Core™2 Extreme / Core™2 Duo / Pentium® dual-core / Celeron® dual-core / Celeron® processors.



---

Ensure that all power cables are unplugged before installing the CPU.

---



- Upon purchase of the motherboard, ensure that the PnP cap is on the socket and the socket contacts are not bent. Contact your retailer immediately if the PnP cap is missing, or if you see any damage to the PnP cap/socket contacts/motherboard components. ASUS will shoulder the cost of repair only if the damage is shipment/transit-related.
  - Keep the cap after installing the motherboard. ASUS will process Return Merchandise Authorization (RMA) requests only if the motherboard comes with the cap on the LGA775 socket.
  - The product warranty does not cover damage to the socket contacts resulting from incorrect CPU installation/removal, or misplacement/loss/incorrect removal of the PnP cap.
- 



---

This motherboard supports Intel® Hyper-Threading Technology and Enhanced Intel SpeedStep® Technology (EIST).

---

## 1.4 System memory

### 1.4.1 Overview

This motherboard comes with four Double Data Rate 2 (DDR2) Dual Inline Memory Module (DIMM) sockets. A DDR2 DIMM has the same physical dimensions as a DDR DIMM but has a 240-pin footprint compared to the 184-pin DDR DIMM. DDR2 DIMMs are notched differently to prevent installation on a DDR DIMM socket. The figure illustrates the location of the DDR2 DIMM sockets:

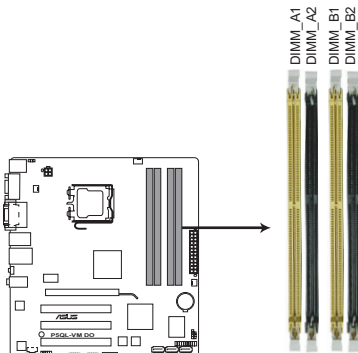

**P5QL-VM DO 240-pin DDR2 DIMM sockets**

## 1.4.2 Memory configurations

You may install a 512MB, 1GB, 2GB, and 4GB unbuffered non-ECC DDR2 DIMM into the DIMM socket.



- You may install varying memory sizes in Channel A and Channel B. The system maps the total size of the lower-sized channel for the dual-channel configuration. Any excess memory from the higher-sized channel is then mapped for single-channel operation.
- For dual-channel configuration, you can:
  - install two identical DIMMs in DIMM\_A1 and DIMM\_B1; or
  - install four identical DIMMs in all four slots; or
  - install one identical DIMM pair in DIMM\_A1 and DIMM\_B1 (yellow slots) and another identical DIMM pair in DIMM\_A2 and DIMM\_B2 (black slots).
- Due to the memory address limitation on the 32-bit Windows® OS, when you install 4GB or more memory on the motherboard, the actual usable memory for the OS can be about 3GB or less. For effective use of memory, we recommend that you do either of the following:
  - Install a maximum of 3GB system memory if you are using a 32-bit Windows® OS.
  - Use a 64-bit Windows® OS if you want to install 4GB or more memory on the motherboard.
- This motherboard does not support DIMMs made up of 256 megabits (Mb) chips or less.



- This motherboard supports up to 16GB on Windows® XP Professional x64 and Windows® Vista x64 editions. You may install a maximum of 4GB DIMMs on each slot.
- The default memory operation frequency is dependent on its Serial Presence Detect (SPD), which is the standard way of accessing information from a memory module. Under the default state, some memory modules for overclocking may operate at a lower frequency than the vendor-marked value.
- For system stability, use a more efficient cooling system to support a full memory load (4 DIMMs) or overclocking conditions.

## P5Q-VM DO Motherboard Qualified Vendors List (QVL)

### DDR2-800MHz capability

Vendor	Part No.	Size	SS/DS	Chip Brand	Chip No.	Timing DIMM (BIOS)	Voltage	DIMM Support		
								A*	B*	C*
A-Data	AD2800E001G0U	2048MB(Kit of 2)	SS	N/A	Heat-Sink Package	4-4-4-12	2.0-2.1V	•	•	•
A-Data	M2GVD6G314170Q1E58	1024MB	DS	VDATA	VD29608A8A-25EG80813			•	•	
A-Data	AD2800002GMU	2048MB	DS	Hynix	Heat-Sink Package			•	•	•
A-Data	AD2800E002G0U	4096MB(Kit of 2)	DS	N/A	Heat-Sink Package	4-4-4-12	1.9-2.1V	•	•	•
Apacer	78.91G91.9K5	512MB	SS	Apacer	AM4B5708JQJS8E0751C	5		•	•	
Apacer	78.01GA0.9L5	1024MB	SS	Apacer	AM4B5808FEWS8E0909C	5		•	•	•
Corsair	CM2X1024-6400	1024MB	DS	Corsair	Heat-Sink Package			•	•	
Corsair	XMS2-6400	1024MB	DS	Corsair	Heat-Sink Package	4		•	•	•

*continued on the next page*

Vendor	Part No.	Size	SS/DS	Chip Brand	Chip No.	Timing DIMMI (BIOS)	Voltage	DIMM Support		
								A*	B*	C*
Corsair	XMS2-6400	1024MB	DS	Corsair	Heat-Sink Package	5		*	*	*
Corsair	CM2X2048-6400C5DHX	4096MB(Kit of 2)	DS	N/A	Heat-Sink Package	5		*	*	
Corsair	CM2X2048-6400C5	4096MB(Kit of 2)	DS	N/A	Heat-Sink Package	5		*	*	
Crucial	BL12864AL80A.8FE5(EPP)	2048MB(kit of 2)	SS	N/A	Heat-Sink Package	4-4-4-12		*	*	*
Crucial	BL25664AL80A.16FE5(EPP)	4096MB(kit of 2)	DS	N/A	Heat-Sink Package	4-4-4-12		*	*	*
Crucial	BL25664AR80A.16FE5(EPP)	4096MB(kit of 2)	DS	N/A	Heat-Sink Package	4-4-4-12		*	*	*
G.SKILL	F2-6400CL5D-1GBNQ	512MB	SS	G.SKILL	Heat-Sink Package SN:8151030036642	5-5-5-15		*	*	*
G.SKILL	F2-6400CL4D-2GBPK	1024MB	DS	G.SKILL	Heat-Sink Package	4		*	*	*
G.SKILL	F2-6400CL5D-2GBNQ	1024MB	DS	G.SKILL	Heat-Sink Package	5		*	*	*
G.SKILL	F2-6400CL4D-4GBPK	2048MB	DS	G.SKILL	Heat-Sink Package	4		*	*	*
G.SKILL	F2-6400CL5D-4GBPK	2048MB	DS	G.SKILL	Heat-Sink Package	5		*	*	*
G.SKILL	F2-6400CL6Q-16GMQ	4096MB	DS	N/A	Heat-Sink Package	5		*	*	*
GEIL	GB22GB6400C4DC	1024MB	DS	GEIL	GL2L64M088BA30EB	5		*	*	*
GEIL	GB22GB6400C5DC	1024MB	DS	GEIL	GL2L64M088BA30EB	5		*	*	*
GEIL	GB24GB6400C4QC	1024MB	DS	GEIL	GL2L64M088BA30EB	4		*	*	*
GEIL	GB24GB6400C5QC	1024MB	DS	GEIL	GL2L64M088BA30EB	5		*	*	*
GEIL	GE22GB800C4DC	1024MB	DS	GEIL	Heat-Sink Package	4		*	*	*
GEIL	GE22GB800C5DC	1024MB	DS	GEIL	Heat-Sink Package	5		*	*	*
GEIL	GE24GB800C4QC	1024MB	DS	GEIL	Heat-Sink Package	4		*	*	*
GEIL	GE24GB800C5QC	1024MB	DS	GEIL	Heat-Sink Package	5		*	*	*
GEIL	GX22GB6400DC	1024MB	DS	GEIL	Heat-Sink Package	5	1.8V	*	*	*
GEIL	GX22GB6400UDC	1024MB	DS	GEIL	Heat-Sink Package	4		*	*	*
GEIL	GB24GB6400C5DC	2048MB	DS	GEIL	GL2L128M88BA25AB	5		*	*	
GEIL	GB28GB6400C4QC	2048MB	DS	GEIL	GL2L128M88BA25AB	4		*	*	*
GEIL	GB28GB6400C5QC	2048MB	DS	GEIL	GL2L128M88BA25AB	5		*	*	*
GEIL	GE24GB800C4DC	2048MB	DS	GEIL	Heat-Sink Package	4		*	*	*
GEIL	GE24GB800C5DC	2048MB	DS	GEIL	Heat-Sink Package	5		*	*	*
GEIL	GE28GB800C4QC	2048MB	DS	GEIL	Heat-Sink Package	4		*	*	*
GEIL	GE28GB800C5QC	2048MB	DS	GEIL	Heat-Sink Package	5		*	*	*
GEIL	GX22GB6400C4USC	2048MB	DS	GEIL	Heat-Sink Package	4		*	*	
GEIL	GX22GB6400LX	2048MB	DS	GEIL	Heat-Sink Package	5		*	*	*
GEIL	GX24GB6400DC	2048MB	DS	GEIL	Heat-Sink Package	5		*	*	*
GEIL	GX24GB6400DC	2048MB	DS	GEIL	Heat-Sink Package	5		*	*	*
Kingmax	KLDC28F-A8KI5	512MB	SS	Kingmax	KKABFF1XF-JFS-25A			*	*	
Kingmax	KKB8FFBFX-CFA-25U	1024MB	SS	Kingmax	KLDD48F-B8KB5			*	*	
kingmax	KLDE88F-B8KB5	2048MB	DS	kingmax	KKB8FFBFX-CFA-25U			*	*	*
Kingston	KVR800D2N6/ 512	512MB	SS	Kingston	KVR800D2N6/ 512	6		*	*	*
Kingston	KHX6400D2LLK2/1GN	1024M(Kit of 2)	SS	Kingston	Heat-Sink Package	4-4-4-12	2.0V	*	*	
Kingston	KVR800D2N5/1G(low profile)	1024MB	SS	Kingston	D1288TEFCGL25U	5	1.8V			
Kingston	KVR800D2N6/1G(low profile)	1024MB	DS	Elpida	E510BAJBG-8E-E	6	1.8V	*	*	*
Kingston	KHX6400D2K2/2G	2048MB(Kit of 2)	DS	N/A	Heat-Sink Package	5-5-5-15	2.0V	*	*	*
Kingston	KVR800D2N5/2G(low profile)	2048MB	DS	Kingston	D1288TPFCGL25U	5	1.8V	*	*	*
Kingston	KVR800D2N6/2G(low profile)	2048MB	DS	Elpida	E8105ACBG-8E-E	6	1.8V	*	*	*
Kingston	KVR800D2N6/4G	4096MB	DS	Elpida	E2108ABSE-8G-E	6	1.8V	*	*	*
Micron	MT16HTF25664AY-800G1	2048MB	DS	Micron	8AG27 D9JWB	6-6-6-12		*	*	*
Micron	MT16HTF25664AY-800G1	2048MB	DS	Micron	8AG27 D9JWB	6-6-6-12		*	*	*
OCZ	OCZ2G800R22GK	1024MB	DS	OCZ	Heat-Sink Package	4-5-5-15	2.0V	*	*	*
OCZ	OCZ2P800R22GK	1024MB	DS	OCZ	Heat-Sink Package	4-4-4-15	1.9 -2.1V	*	*	*

(continued on the next page)

## DDR2-800MHz capability

Vendor	Part No.	Size	SS/ DS	Chip Brand	Chip No.	Timing DIMM (BIOS)	Voltage	DIMM Support		
								A*	B*	C*
OCZ	OC2Z2P8R002GK	1024MB	DS	OCZ	Heat-Sink Package	4-4-4-15	2.1V	*	*	*
OCZ	OC2ZVU8004GK	1024MB	DS	OCZ	Heat-Sink Package	5-6-6-18	1.8V	*	*	*
OCZ	OC2Z2SE8002GK	2048MB(Kit of 2)	DS	N/A	Heat-Sink Package	5-5-5-15	1.8V	*	*	*
OCZ	OC2Z2F8004GK(EPP)	2048MB	DS	N/A	Heat-Sink Package	5-4-4-18	2.1V	*	*	*
OCZ	OC2Z2P8004GK	4096MB(Kit of 2)	DS	N/A	Heat-Sink Package	5-4-4-15	2.1v	*	*	*
PSC	AL7E8F73C-8E1	1024MB	SS	PSC	A3R1GE3CFF734MAA0E	5		*	*	*
PSC	AL7E8G73F-8E1	1024MB	SS	PSC	P3R1GE3FGF850MAC19			*	*	*
PSC	AL8E8F73C-8E1	2048MB	DS	PSC	A3R1GE3CFF734MAA0E	5		*	*	*
PSC	AL8E8G73F-8E1	2048MB	DS	PSC	P3R1GE3FGF850MAC19			*	*	*
PSC	PL8E8F73C-8E1	2048MB	DS	PSC	SHG772-AA3G	5		*	*	*
PSC	PL8E8G73E-8E1	2048MB	DS	PSC	XCP271A3G-A	5		*	*	*
Qimonda	HYS64T256020EU-2.5-C2	2048MB	DS	Qimonda	HY818T1G800C2F-2.5	5		*	*	*
Samsung	K4T51083QG-HCF7	512MB	SS	Qimonda	M378T6553GZ3-CF7	6		*	*	*
Samsung	K4T1G084QQ-HCF7	1024MB	SS	Qimonda	M378T2863QZ3-CF7	6		*	*	*
Samsung	M378T2863EHS-CF7	1024MB	SS	Samsung	K4T1G084QE			*	*	*
Samsung	K4T51083QG-HCF7	1024MB	DS	Samsung	M378T2953GZ3-CF7	6		*	*	*
Samsung	M378T2953GZ3-CF7	1024MB	DS	Samsung	K4T51083QG			*	*	*
Samsung	K4T1G084QQ-HCF7	1024MB	DS	Samsung	M378T5663QZ3-CF7	6		*	*	*
Samsung	M378T5263AZ3-CF7	4096MB	DS	Samsung	K4T2G084QA-HCF7			*	*	*
Super Talent	T800UB1GC4	1024MB	DS	Super Talent	Heat-Sink Package	4	1.8V	*	*	*
Transcend	TS64MLQ64V8J	512MB	SS	Micron	7HD22 D9GMH	5		*	*	*
Transcend	JM800QLU-1G	1024MB	SS	Transced	TQ1243PCF8	5		*	*	*
Transcend	TS128MLQ64V8U	1024MB	SS	ELPIDA	E1108ACBG-8E-E	5		*	*	*
Transcend	JM800QLJ-1G	1024MB	DS	Transced	TQ123PJF8F0801	5		*	*	*
Transcend	JM800QLJ-1G	1024MB	DS	Transced	TQ123YBF8 T0747	5		*	*	*
Transcend	TS128MLQ64V8J	1024MB	DS	Micron	7HD22D9GMH	5		*	*	*
Transcend	JM800QLU-2G	2048MB	DS	Transced	TQ243PCF8	5		*	*	*
Transcend	TS256MLQ64V8U	2048MB	DS	Elpida	E1108ACBG-8E-E	5		*	*	*

## DDR2-667MHz capability

Vendor	Part No.	Size	SS/ DS	Chip Brand	Chip No.	Timing DIMM (BIOS)	Voltage	DIMM Support		
								A*	B*	C*
A-Data	M2OAD5H3J41701C53	2048MB	DS	ADATA	AD20908A8A-3EG 30724			*	*	*
Apacer	78.91G92.9K5	512MB	SS	Apacer	AM4B5708JQJ57E0751C	5		*	*	*
Apacer	AU 512E667C5KBGC	512MB	SS	Apacer	AM4B5708GQJ57E06332F	5		*	*	*
Apacer	AU 512E667C5KBGC	512MB	SS	Apacer	AM4B5708MIJ57E0627B	5		*	*	*
Apacer	78.01G90.9K5	1024MB	SS	Apacer	AM4B5808CQJ57E0751C	5		*	*	*
Apacer	AU01GE667C5KBGC	1024MB	DS	Apacer	AM4B5708GQJ57E0636B			*	*	*
Apacer	AU01GE667C5KBGC	1024MB	DS	Apacer	AM4B5708MIJ57E0627B	5		*	*	*
Apacer	AM4B5808CQJ57E0749B	2048MB	DS	Apacer	78.A1G90 9K4	5		*	*	*
Corsair	VS 512MB667D2	512MB	DS	Corsair	MIII0052532M8CEC			*	*	*
Corsair	VS1GB667D2	1024MB	DS	Corsair	MID095D62864M8CEC			*	*	*
Corsair	XMS2-5400	1024MB	DS	Corsair	Heat-Sink Package	4		*	*	*
G.SKILL	F2-5400PHU2-2GBNT	2048MB(Kit of 2)	DS	G.SKILL	D2 64M8CCF 0815 C7173S	5-5-5-15		*	*	*
G.SKILL	F2-5300CL5D-4GBMQ	4096MB(Kit of 2)	DS	G.SKILL	Heat-Sink Package SN:8151030036559	5-5-5-15		*	*	*
GEIL	GX21GB5300SX	1024MB	DS	GEIL	Heat-Sink Package	3		*	*	*

continued on the next page

## DDR2-667MHz capability

Vendor	Part No.	Size	SS/ DS	Chip Brand	Chip No.	Timing DIMM (BIOS)	Voltage	DIMM Support		
								A*	B*	C*
GEIL	GX22GB5300LX	2048MB	DS	GEIL	Heat-Sink Package	5		•	•	
GEIL	GX24GB5300LDC	2048MB	DS	GEIL	Heat-Sink Package	5		•	•	•
Kingmax	KLCC28F-A8KB5	512MB	SS	Kingmax	KKEA88B4LAUG-29DX			•	•	•
Kingmax	KLCD48F-A8KB5	1024MB	DS	Kingmax	KKEA88B4LAUG-29DX			•	•	•
Kingston	KVR667D2N5/ 512(low profile)	512MB	SS	Kingston	D6408TR7CGL25U	5	1.8V	•	•	•
Kingston	KVR667D2N5/1G(low profile)	1024MB	DS	PSC	E5108AJBG-8E-E	5	1.8V			
Kingston	KVR667D2N5/2G(low profile)	2048MB	DS	Elpida	E1108ACBG-8E-E	5	1.8V	•	•	•
Micron	MT8HTF12864AY-667E1	1024MB	SS	Micron	D9HNL 7ZE17	5		•	•	
PSC	AL6E8E63J-6E1	512MB	SS	PSC	A3R12E3JFF717B9A00	5		•	•	•
PSC	AL7E8F73C-6E1	1024MB	SS	PSC	A3R1GE3CFF734MAA0J	5		•	•	•
PSC	AL6E8E63J-6E1	1024MB	DS	PSC	A3R12E3JFF717B9A01	5		•	•	•
PSC	AL8E8F73C-6E1	2048MB	DS	PSC	A3R1GE3CFF733MAA00	5		•	•	•
Samsung	M378T5263AZ3-CE6	4096MB	DS	Samsung	K4T2G084QA-HCE6			•	•	•
Super Talent	T667UB1GV	1024MB	DS	Super Talent	PG 64M8-800 0750	5	1.8V	•	•	•
Transcend	JM667QLU-1G	1024MB	SS	Transcend	TQ243PCF8T0838	5		•	•	
Transcend	JM667QLJ-1G	1024MB	DS	Elpida	E5108AJBG-6E-E	5		•	•	•
Transcend	JM667QLU-2G	2048MB	DS	Transcend	TQ243PCF8T0834	5		•	•	•
Twinmos	8D-A3JK5MPETP	512MB	SS	PSC	A3R12E3GEF633ACA0Y	5		•	•	•



### SS - Single-sided / DS - Double - sided

#### DIMM support:

- **A\***: Supports one module inserted into any slot as Single-channel memory configuration.
- **B\***: Supports one pair of modules inserted into either the yellow or black slots as one pair of Dual-channel memory configuration.
- **C\***: Supports four modules inserted into both the yellow and black slots as two pairs of Dual-channel memory configuration.



Visit the ASUS website at [www.asus.com](http://www.asus.com) for the latest QVL.



## 1.5 Expansion slots

In the future, you may need to install expansion cards. The following sub-sections describe the slots and the expansion cards that they support.



---

Unplug the power cord before adding or removing expansion cards. Failure to do so may cause you physical injury and damage motherboard components.

---

### 1.5.1 Installing an expansion card

To install an expansion card:

1. Before installing the expansion card, read the documentation that comes with it and make the necessary hardware settings for the card.
2. Remove the chassis cover (if your motherboard is already installed in a chassis).
3. Remove the bracket opposite the slot that you intend to use.
4. Align the card connector with the slot and press firmly until the card is completely seated on the slot.
5. Secure the card to the chassis with the screw.
6. Replace the chassis cover.

### 1.5.2 Configuring an expansion card

After installing the expansion card, configure it by adjusting the software settings.

1. Turn on the system and change the necessary BIOS settings, if any. See Chapter 2 for information on BIOS setup.
2. Assign an IRQ to the card.
3. Install the software drivers for the expansion card.



---

When using PCI cards on shared slots, ensure that the drivers support "Share IRQ" or that the cards do not need IRQ assignments; otherwise, conflicts will arise between the two PCI groups, making the system unstable and the card inoperable.

---

### 1.5.3 PCI slots

The PCI slots support cards such as LAN cards, SCSI cards, USB cards, and other cards that comply with the PCI specifications.

### 1.5.4 PCI Express x16 slot

This motherboard supports PCI Express x16 graphics cards that comply with the PCI Express specifications.

## 1.6 Jumpers

### 1. Clear RTC RAM (3-pin CLRTC)

This jumper allows you to clear the Real Time Clock (RTC) RAM in CMOS. You can clear the CMOS memory of date, time, and system setup parameters by erasing the CMOS RTC RAM data. The onboard button cell battery powers the RAM data in CMOS, which include system setup information such as system passwords.

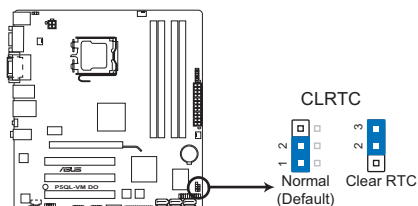

#### P5QL-VM DO Clear RTC RAM

To erase the RTC RAM:

1. Turn OFF the computer and unplug the power cord.
2. Move the jumper cap from pins 1-2 (default) to pins 2-3 for about 5-10 seconds, then move the cap back to pins 1-2.
3. Plug the power cord and turn ON the computer.
4. Hold down the <Del> key during the boot process and enter BIOS setup to reenter data.



Except when clearing the RTC RAM, never remove the cap on CLRTC jumper default position. Removing the cap will cause system boot failure!



- If the steps above do not help, remove the onboard battery and move the jumper again to clear the CMOS RTC RAM data. After clearing the CMOS, reinstall the battery.
- You do not need to clear the RTC when the system hangs due to overclocking. For system failure due to overclocking, use the CPU Parameter Recall (C.P.R.) feature. Shut down and cut off the AC power, then reboot the system, the BIOS automatically resets parameter settings to default values.

### 2. Keyboard power (3-pin KBPWR)

This jumper allows you to enable or disable the keyboard wake-up feature. When you set this jumper to pins 2-3 (+5VSB), you can wake up the computer by pressing a key on the keyboard (the default is the Space Bar). This feature requires an ATX power supply that can supply at least 1A on the +5VSB lead, and a corresponding setting in the BIOS.

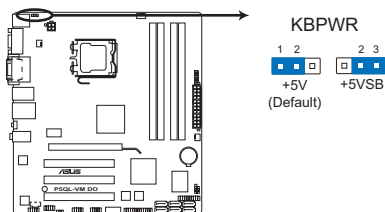

#### P5QL-VM DO Keyboard Power Setting

### 3. USB device wake-up (3-pin USBPW7-10)

Set the jumper to +5V to wake up the computer from S1 sleep mode (CPU stopped, DRAM refreshed, system running in low power mode) using the connected USB devices. Set to +5VSB to wake up from S3 and S4 sleep modes (no power to CPU, DRAM in slow refresh, power supply in reduced power mode).

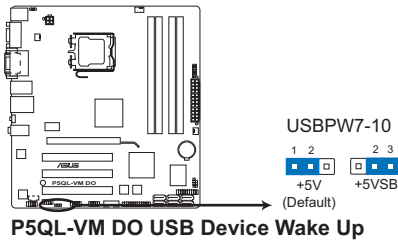

- The USB device wake-up feature requires a power supply that can provide 500mA on the +5VSB lead for each USB port; otherwise, the system would not power up.
- The total current consumed must NOT exceed the power supply capability (+5VSB) whether under normal condition or in sleep mode.

## 1.7 Connectors

### 1.7.1 Rear panel ports

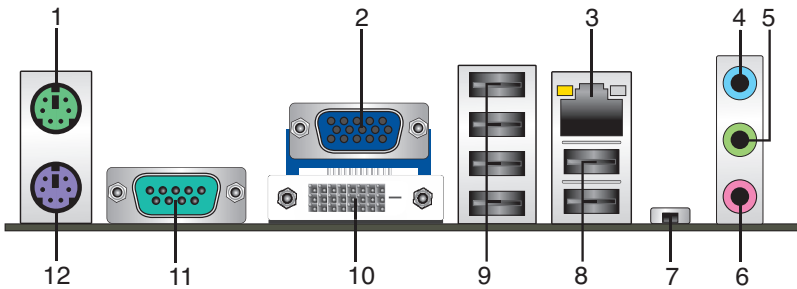

1. **PS/2 Mouse port.** This port is for a PS/2 mouse.
2. **Video Graphics Adapter (VGA) port.** This 15-pin port is for a VGA monitor or other VGA-compatible devices.
3. **LAN (RJ-45) port.** This port allows Gigabit connection to a Local Area Network (LAN) through a network hub. Refer to the table on the next page for the LAN port LED indicators.

## LAN port LED indications

ACT/LINK LED		SPEED LED	
Status	Description	Status	Description
OFF	No link	OFF	10 Mbps connection
ORANGE	Linked	ORANGE	100 Mbps connection
BLINKING	Data activity	GREEN	1 Gbps connection

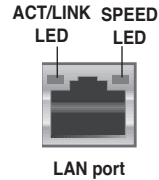

- Line In port (light blue).** This port connects to the tape, CD, DVD player, or other audio sources.
- Line Out port (lime).** This port connects to a headphone or a speaker. In 4-channel and 6-channel configurations, the function of this port becomes Front Speaker Out.
- Microphone port (pink).** This port connects to a microphone.



Refer to the audio configuration table below for the function of the audio ports in 2, 4, or 6-channel configuration.

## Audio 2, 4, 6-channel configuration

Port	Headset 2-channel	4-channel	6-channel
Light Blue	Line In	Rear Speaker Out	Rear Speaker Out
Lime	Line Out	Front Speaker Out	Front Speaker Out
Pink	Mic In	Mic In	Bass/Center

- ME Switch.** Allows you to enable or disable the Intel® ME function. Push the switch to ON/OFF labelled on the I/O Shield to enable/disable this function.



Disable Intel® ME function before updating BIOS.

- USB 2.0 ports 1 and 2.** These two 4-pin Universal Serial Bus (USB) ports connect to USB 2.0/1.1 devices.
- USB 2.0 ports 3, 4, 5, and 6.** These four 4-pin Universal Serial Bus (USB) ports connect to USB 2.0/1.1 devices.
- DVI port.** This port is for any DVI-D compatible device. DVI-D can't be converted to output RGB Signal to CRT and isn't compatible with DVI-I.
- COM port.** This 9-pin COM1 port is for pointing devices or other serial devices.
- PS/2 Keyboard port.** This port is for a PS/2 keyboard.

## 1.7.2 Internal connectors

### 1. Serial ATA connectors (7-pin SATA1-6)

These connectors are for the Serial ATA signal cables for Serial ATA 3Gb/s hard disk and optical disk drives. The Serial ATA 3Gb/s is backward compatible with Serial ATA 1.5Gb/s specification. The data transfer rate of the Serial ATA 3Gb/s is faster than the standard parallel ATA with 133MB/s (Ultra DMA133).

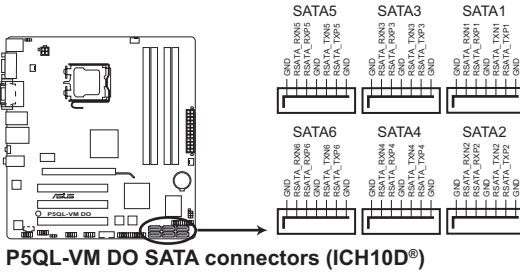

Install the Windows® XP Service Pack 2 or later version before using Serial ATA.

### 2. Optical drive audio in connector (4-pin CD)

This connector allows you to receive stereo audio input from sound sources such as a CD-ROM, TV tuner, or MPEG card.

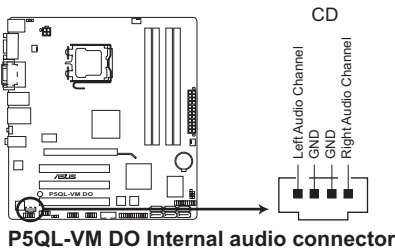

### 3. USB connectors (10-1 pin USB78, USB910)

These connectors are for USB 2.0 ports. Connect the USB module cable to any of these connectors, then install the module to a slot opening at the back of the system chassis. These USB connectors comply with the USB 2.0 specification that supports up to 480Mbps connection speed.

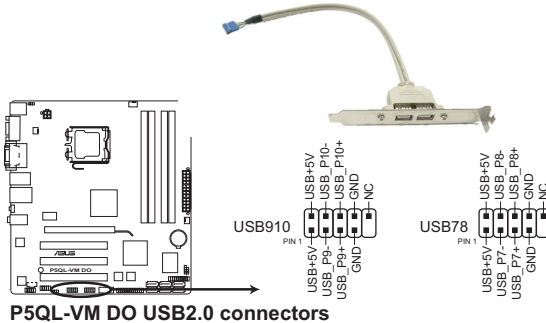

Never connect a 1394 cable to the USB connectors. Doing so will damage the motherboard!



The USB 2.0 module is purchased separately.

### 4. CPU, Chassis, and Power fan connectors (4-pin CPU\_FAN, 3-pin CHA\_FAN, 3-pin PWR\_FAN)

The fan connectors support cooling fans of 350 mA ~ 2000 mA (24 W max.) or a total of 1 A ~ 7 A (84 W max.) at +12V. Connect the fan cables to the fan connectors on the motherboard, making sure that the black wire of each cable matches the ground pin of the connector.



DO NOT forget to connect the fan cables to the fan connectors. Insufficient air flow inside the system may damage the motherboard components. They are not jumpers! DO NOT place jumper caps on the fan connectors.

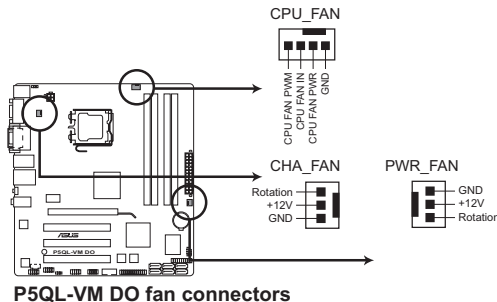

Only the CPU fan supports the ASUS Q-FAN feature.

**5. ATX power connectors (24-pin EATXPWR, 4-pin ATX12V)**

These connectors are for an ATX power supply. The plugs from the power supply are designed to fit these connectors in only one orientation. Find the proper orientation and push down firmly until the connectors completely fit.

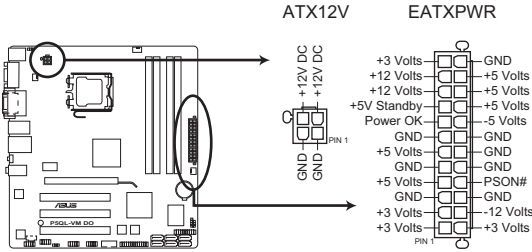

- We recommend that you use an ATX 12V Specification 2.0-compliant power supply unit (PSU) with a minimum of 300W power rating. This PSU type has 24-pin and 4-pin power plugs.
- If you intend to use a PSU with 20-pin and 4-pin power plugs, make sure that the 20-pin power plug can provide at least 15 A on +12 V and that the PSU has a minimum power rating of 300 W. The system may become unstable or may not boot up if the power is inadequate.
- DO NOT forget to connect the 4-pin ATX +12 V power plug; otherwise, the system will not boot up.
- We recommend that you use a PSU with higher power output when configuring a system with more power-consuming devices or when you intend to install additional devices. The system may become unstable or may not boot up if the power is inadequate.
- If you are uncertain about the minimum power supply requirement for your system, refer to the Recommended Power Supply Wattage Calculator at <http://support.asus.com/PowerSupplyCalculator/PSCalculator.aspx?SLanguage=en-us> for details.

## 6. System panel connector (10-1 pin F\_PANEL)

This connector supports several chassis-mounted functions.

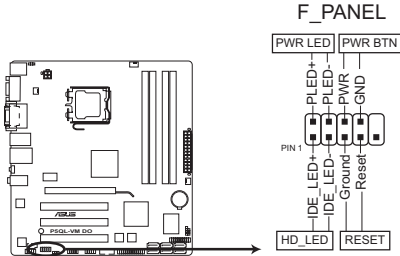

**P5QL-VM DO System panel connector**

- **System power LED (2-pin PLED)**

This 2-pin connector is for the system power LED. Connect the chassis power LED cable to this connector. The system power LED lights up when you turn on the system power, and blinks when the system is in sleep mode.

- **Hard disk drive activity LED (2-pin +HDLED)**

This 2-pin connector is for the HDD Activity LED. Connect the HDD Activity LED cable to this connector. The IDE LED lights up or flashes when data is read from or written to the HDD.

- **Power/Soft-off button (2-pin PWRBTN)**

This 2-pin connector is for the system power button. Pressing the power button turns the system ON or puts the system in SLEEP or SOFT-OFF mode depending on the BIOS settings. Pressing the power switch for more than four seconds while the system is ON turns the system OFF.

- **Reset button (2-pin RESET)**

This 2-pin connector is for the chassis-mounted reset button for system reboot without turning off the system power.

## 7. LPT connector (26-1 pin LPT)

The LPT (Line Printing Terminal) connector supports devices such as a printer. LPT standardizes as IEEE 1284, which is the parallel port interface on IBM PC-compatible computers.

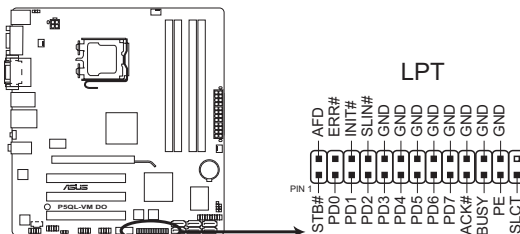

**P5QL-VM DO Parallel Port Connector**



**8. Front panel audio connector (10-1 pin AAFP)**

This connector is for a chassis-mounted front panel audio I/O module that supports either High Definition Audio or AC'97 audio standard. Connect one end of the front panel audio I/O module cable to this connector.

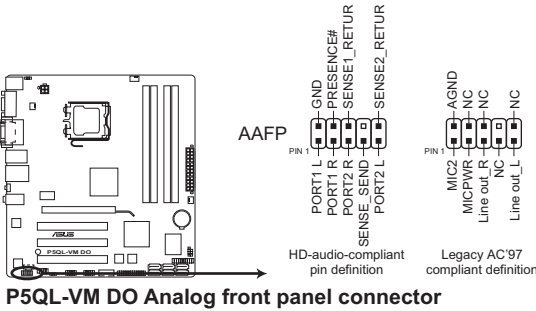

If you want to connect a high-definition front panel audio module to this connector, ensure that the **Front Panel Type** item in the BIOS is set to **[HD Audio]**. If you want to connect an AC97 front panel audio module to this connector, set the item to **[AC97]**. See page 2-11 for details.

**9. Chassis intrusion connector (4-1 pin CHASSIS)**

This connector is for a chassis-mounted intrusion detection sensor or switch. The chassis intrusion sensor or switch sends a high-level signal to this connector when a chassis component is removed or replaced. The signal is then generated as a chassis intrusion event.

By default , the pin labeled “Chassis Signal” and “Ground” are shorted with a jumper cap. Remove the jumper caps only when you intend to use the chassis intrusion detection feature.

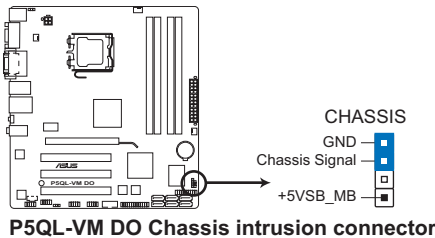

## 10. Serial port connectors (10-1 pin COM2)

The connector is for a serial (COM) port. Connect the serial port module cable to the connector, then install the module to a slot opening at the back of the system chassis.



The serial port bracket (COM2) is purchased separately.

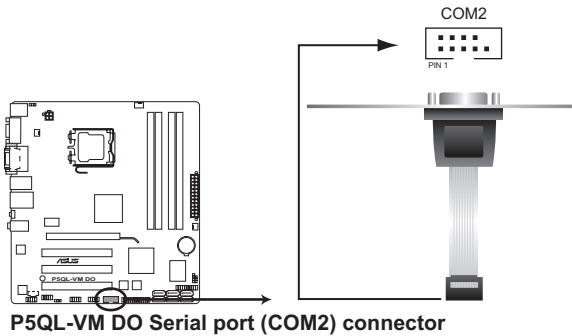

## 11. TPM connector (20-1 pin TPM)

This connector supports a Trusted Platform Module (TPM) system, which can securely store keys, digital certificates, passwords, and data. A TPM system also helps enhance network security, protects digital identities, and ensures platform integrity.

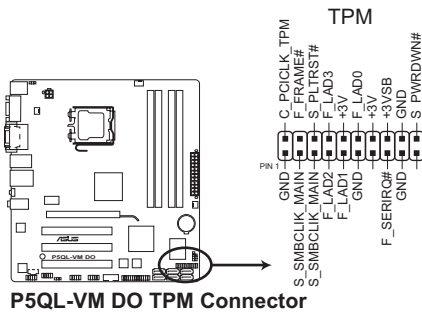

The TPM module is purchased separately.

# 1.8 Software support

## 1.8.1 Installing an operating system

This motherboard supports Windows® XP/Vista Operating Systems (OS). Always install the latest OS version and corresponding updates to maximize the features of your hardware.



- Motherboard settings and hardware options vary. Refer to your OS documentation for detailed information.
- Ensure that you install Windows® XP Service Pack 2 or later versions / Windows® Vista Service Pack 1 or later versions before installing the drivers for better compatibility and system stability.

## 1.8.2 Support DVD information

The Support DVD that comes with the motherboard package contains drivers, software applications, and utilities that you can install to get all motherboard features.

### To run the Support DVD

Place the Support DVD into the optical drive. The DVD automatically displays the **Drivers** menu if the Autorun function is enabled on your computer.



The contents of the Support DVD are subject to change at any time without notice. Visit the ASUS website at [www.asus.com](http://www.asus.com) for updates.

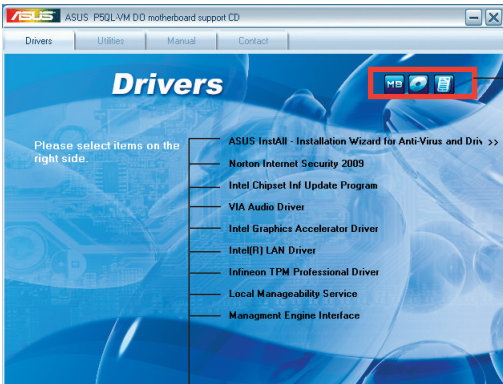

Click an icon to display Support DVD/ motherboard information

Click an item to install



If the Autorun function is NOT enabled on your computer, browse the contents of the Support DVD to locate the file **ASSETUP.EXE** from the **BIN** folder. Double-click **ASSETUP.EXE** to run the DVD.

# Chapter 2

## BIOS information

### 2.1 Managing and updating your BIOS



---

Save a copy of the original motherboard BIOS file to a USB flash disk in case you need to restore the BIOS in the future. Copy the original motherboard BIOS using the ASUS Update utility.

---

#### 2.1.1 ASUS Update utility

The ASUS Update is a utility that allows you to manage, save, and update the motherboard BIOS in Windows® environment.



- ASUS Update requires an Internet connection either through a network or an Internet Service Provider (ISP).
  - This utility is available in the Support DVD that comes with the motherboard package.
- 

#### Installing ASUS Update:

1. Place the Support DVD into the optical drive. The **Drivers** menu appears.
2. Click the **Utilities** tab, then click **ASUS Update**.
3. Follow the onscreen instructions to complete the installation.



---

Quit all Windows® applications before you update the BIOS using this utility.

---

#### Updating the BIOS:

To update the BIOS:

1. From the Windows® desktop, Click **Start > Programs > ASUS > ASUS Update > ASUS Update** to launch the ASUS Update utility.
2. From the dropdown list, select either of the following methods:

##### *Updating from the Internet*

- a. Select **Update BIOS from the Internet**, then click **Next**.
- b. Select the ASUS FTP site nearest you to avoid network traffic, or click **Auto Select** then click **Next**.
- c. From the FTP site, select the BIOS version you want to download then click **Next**.



---

The ASUS Update utility is capable of updating itself through the Internet. Always update the utility to get all its features.

---

*Updating from a BIOS file*

- a. **Select Update BIOS from a file**, then click **Next**.
  - b. Locate the BIOS file from the **Open** window, then click **Open**.
3. Follow the onscreen instructions to complete the updating process.

## 2.1.2 ASUS EZ Flash 2 utility

The ASUS EZ Flash 2 feature allows you to update the BIOS without using an OS-based utility.



---

Download the latest BIOS file from the ASUS website at [www.asus.com](http://www.asus.com).

---

To update the BIOS using EZ Flash 2:

1. Insert the USB flash disk that contains the latest BIOS file to a USB port, then launch EZ Flash 2 in either of the following ways.
  - Press **<Alt> + <F2>** during POST to display the following:

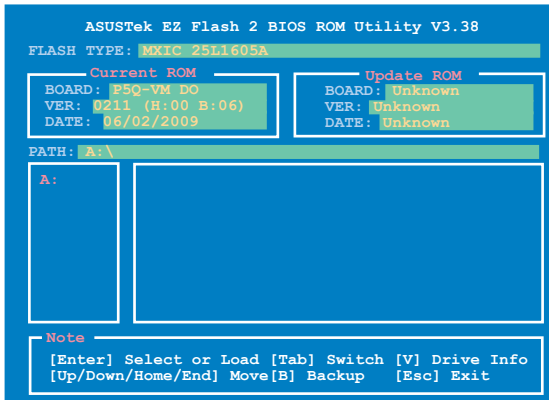

- Enter the BIOS setup program. Go to the **Tools** menu to select **EZ Flash 2** and press **<Enter>** to enable it.
2. Press **<Tab>** to locate the correct file. Press **<Enter>**.

When the correct BIOS file is found, EZ Flash 2 performs the BIOS updating process and automatically reboots the system when done.



- 
- Only a USB flash disk with **FAT 32/16** format and single partition supports the ASUS EZ Flash 2 utility.
  - **DO NOT** shut down or reset the system while updating the BIOS to prevent system boot failure!
-

## 2.1.3 ASUS CrashFree BIOS 3 utility

The ASUS CrashFree BIOS 3 is an auto recovery tool that allows you to restore the BIOS file when it fails or gets corrupted during the updating process. You can update a corrupted BIOS file using the motherboard Support DVD or a USB flash disk that contains the updated BIOS file.



- Prepare the motherboard Support DVD or a USB flash disk containing the updated motherboard BIOS before using this utility.
- Always connect the SATA cable to the SATA1/2 connector; otherwise, the utility will not function.
- If your display monitor is connected to the onboard DVI port, the display monitor will turn-off when CrashFree BIOS 3 starts updating your system. When the process is finished, the display will turn back on after you restart the system.

### Recovering the BIOS

To recover the BIOS:

1. Turn on the system.
2. Insert the Support DVD or USB flash disk containing the BIOS file to the optical disk drive or a USB port.

The utility displays the following message and automatically checks the Support DVD or the USB flash disk for the BIOS file.

```
Bad BIOS checksum. Starting BIOS recovery...
Checking for CD-ROM...
```

When the BIOS file is found, the utility reads it and starts erasing the corrupted BIOS file.

```
Bad BIOS checksum. Starting BIOS recovery...
Checking for CD-ROM...
CD-ROM found!
Reading file "P5QLVMD0.ROM". Completed.
Start Erasing...
Start Programming...
```

3. Restart the system after the utility completes the updating process.



- Only a USB flash disk with FAT 32/16 format and single partition supports ASUS CrashFree BIOS 3. The device size should be smaller than 8GB.
- DO NOT shut down or reset the system while updating the BIOS! Doing so can cause system boot failure!



The recovered BIOS may not be the latest BIOS version for this motherboard. Download the latest BIOS file from the ASUS website at [www.asus.com](http://www.asus.com).

## 2.2 BIOS setup program

Use the BIOS Setup program when you are installing a motherboard, reconfiguring your system, or prompted to “Run Setup.” This section explains how to configure your system using this utility.

If you want to enter Setup after POST, reboot the system by doing any of the following procedures:

- Restart using the OS standard shut-down procedure.
- Press <Ctrl>+<Alt>+<Del> simultaneously.
- Press the reset button on the system chassis.
- Press the power button to turn the system off then back on.



Using the **power button**, **reset button**, or the <Ctrl>+<Alt>+<Del> keys to force reset from a running operating system can cause damage to your data or system. We recommend that you always shut down the system properly from the operating system.



- The default BIOS settings for this motherboard apply to most conditions to ensure optimum performance. If the system becomes unstable after changing any BIOS settings, load the default settings to ensure system compatibility and stability. Select the **Load Setup Defaults** item under the **Exit** menu. See section 2.9 **Exit menu**.
- The BIOS setup screens in this section are for reference only. They may not exactly match what you see on your screen.
- Visit the ASUS website at [www.asus.com](http://www.asus.com) to download the latest BIOS file for this motherboard.

## 2.3 Main menu

When you enter the BIOS Setup program, the **Main** menu screen appears, giving you an overview of the basic system information.

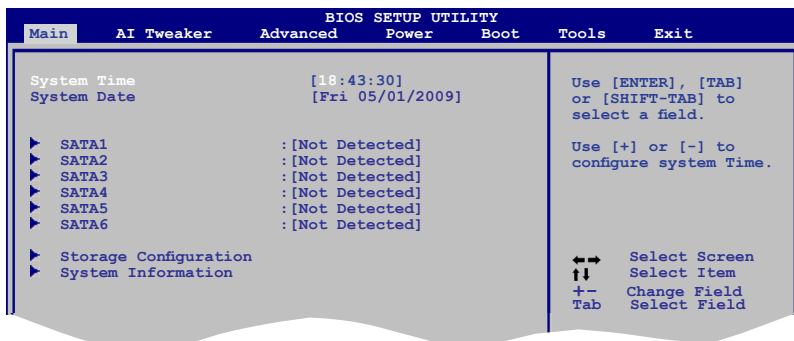

### 2.3.1 System Time [xx:xx:xx]

Allows you to set the system time.

### 2.3.2 System Date [Day xx/xx/xxxx]

Allows you to set the system date.

### 2.3.3 SATA 1-6

While entering Setup, the BIOS automatically detects the presence of SATA devices. There is a separate submenu for each SATA device. Select a device item then press **<Enter>** to display the SATA device information.

The BIOS automatically detects the values opposite the dimmed items (Device, Vendor, Size, LBA Mode, Block Mode, PIO Mode, Async DMA, Ultra DMA, and SMART monitoring). These values are not user-configurable. These items show **Not Detected** if no SATA device is installed in the system.

#### Type [Auto]

Selects the type of IDE drive. Setting to **[Auto]** allows automatic selection of the appropriate IDE device type. Select **[CDROM]** if you are specifically configuring a CD-ROM drive. Select **[ARMD]** (ATAPI Removable Media Device) if your device is either a ZIP, LS-120, or MO drive. Configuration options: [Not Installed] [Auto] [CDROM] [ARMD]

#### LBA/Large Mode [Auto]

Enables or disables the LBA mode. Setting to **[Auto]** enables the LBA mode if the device supports this mode, and if the device was not previously formatted with LBA mode disabled. Configuration options: [Disabled] [Auto]

#### Block (Multi-Sector Transfer) M [Auto]

Enables or disables data multi-sectors transfers. When set to **[Auto]**, the data transfer from and to the device occurs multiple sectors at a time if the device supports multi-sector transfer feature. When set to **[Disabled]**, the data transfer from and to the device occurs one sector at a time. Configuration options: [Disabled] [Auto]

#### PIO Mode [Auto]

Selects the PIO mode. Configuration options: [Auto] [0] [1] [2] [3] [4]

#### DMA Mode [Auto]

Selects the DMA mode. Configuration options: [Auto]

#### SMART Monitoring [Auto]

Sets the Smart Monitoring, Analysis, and Reporting Technology. Configuration options: [Auto] [Disabled] [Enabled]

#### 32Bit Data Transfer [Enabled]

Enables or disables 32-bit data transfer. Configuration options: [Disabled] [Enabled]

### 2.3.4 Storage Configuration

The **Storage Configuration** menu allows you to configure your SATA device(s). Select an item then press **<Enter>** to display the sub-menu.

#### SATA Configuration [Enhanced]

Allows you to enable or disable SATA configuration.

Configuration options: [Disabled] [Compatible] [Enhanced]

##### *Configure SATA as [IDE]*

Sets the configuration for the Serial ATA connectors supported by the Southbridge chip.

Configuration options: [IDE] [AHCI]

The AHCI allows the onboard storage driver to enable advanced Serial ATA features that increases storage performance on random workloads by allowing the drive to internally optimize the order of commands.



### Hard Disk Write Protect [Disabled]

Disables or enables device write protection. This will be effective only if device is accessed through BIOS. Configuration option: [Disabled] [Enabled]

### IDE Detect Time Out (Sec) [35]

Selects the time out value for detecting ATA/ATAPI devices.

Configuration options: [0] [5] [10] [15] [20] [25] [30] [35]

## 2.3.5 System Information

This menu gives you an overview of the general system specifications. The BIOS automatically detects the items in this menu.

### BIOS Information

Displays the auto-detected BIOS information

### Processor

Displays the auto-detected CPU specification

### System Memory

Displays the auto-detected system memory

## 2.4 Ai Tweaker menu

The Ai Tweaker menu items allow you to change the settings for system performance.

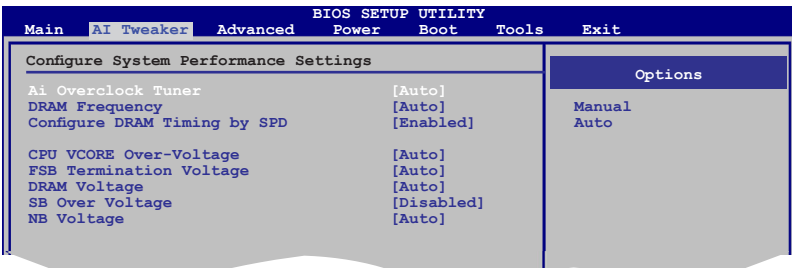

### Ai Overclock Tuner [Auto]

Allows selection of CPU overclocking options to achieve desired CPU internal frequency.

Select either one of the preset overclocking configuration options:

**Manual** - Allows you to individually set overclocking parameters.

**Auto** - Loads the optimal settings for the system.

**Overclock Profile** - Loads the overclock profile.



---

The following two items appear only when you set the **Ai Overclock Tuner** item to [Manual].

---

### FSB Frequency [XXX]

Displays the frequency sent by the clock generator to the system bus and PCI bus. The value of this item is auto-detected by the BIOS. Input the desired CPU frequency using the numeric keypad. The values range from 200 to 800. Refer to the table below for the correct Front Side Bus and CPU External Frequency settings.

#### FSB/CPU External Frequency Synchronization

Front Side Bus	CPU External Frequency
FSB 1600	400 MHz
FSB 1333	333 MHz
FSB 1066	266 MHz
FSB 800	200 MHz

### DRAM Frequency [Auto]

Allows you to set the DDR2 operating frequency.

Configuration options: [Auto] [DDR2-533 MHz] [DDR2-639 MHz] [DDR2-667 MHz] [DDR2-800 MHz]



---

The **DRAM Frequency** configuration options vary with the **FSB Frequency** item settings.

---



Selecting a very high DRAM frequency may cause the system to become unstable! If this happens, revert to the default setting.

---

### Configure DRAM Timing by SPD [Enabled]

Allows you to set the DRAM timing control. Configuration options: [Enabled] [Disabled]

### CPU VCore Over-Voltage [Auto]

Allows you to set the CPU VCore over-voltage. Configuration options: [Auto] [+50mv] [+100mv] [+150mv].



---

Refer to the CPU documentation before setting the CPU Vcore voltage. Setting a high VCore voltage may damage the CPU permanently, and setting a low VCore voltage may make the system unstable.

---

### FSB Termination Voltage [Auto]

Allows you to set the front side bus termination voltage. The values range from 1.20V to 1.30V with a 0.10V interval. Press +/- to adjust the value.

### DRAM Voltage [Auto]

Allows you to set the DRAM voltage. The values range from 1.87V to 2.26V with a 0.13V interval. Press +/- to adjust the value.

## SB Over Voltage [Disabled]

Allows you to enable or disable the South Bridge over voltage. Configuration options: [Disabled] [Enabled].

## NB Voltage [Auto]

Allows you to set the North Bridge voltage. The values range from 1.13V to 1.34V with a 0.07V interval. Press +/- to adjust the value.

## 2.5 Advanced menu

The **Advanced** menu items allow you to change the settings for the CPU and other system devices.



Take caution when changing the settings of the **Advanced** menu items. Incorrect field values can cause the system to malfunction.

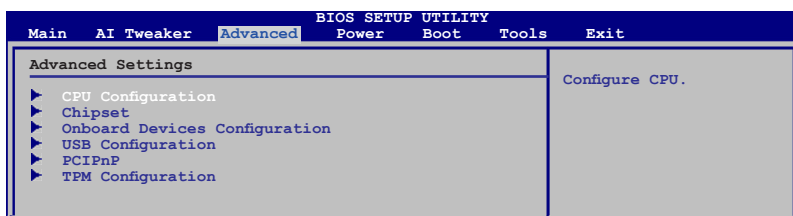

### 2.5.1 CPU Configuration

The items in this menu show the CPU-related information that the BIOS automatically detects.



The items shown in this screen may be different due to the CPU you installed.

#### CPU Ratio Setting [Auto]

Allows you to adjust the ratio between CPU Core Clock and FSB Frequency. Use the <+> and <-> keys to adjust the value.

Configuration options: [Auto] [06.0] [07.0]

#### C1E Support [Enabled]

Allows you to enable or disable Enhanced Halt State support.

Configuration options: [Disabled] [Enabled]

#### Intel(R) Virtualization Tech [Enabled]

The Intel® Virtualization Technology allows a hardware platform to run multiple operating systems separately and simultaneously, enabling one system to virtually function as several systems. Configuration options: [Disabled] [Enabled]

## CPU TM function [Enabled]

This function enables the overheated CPU to throttle the clock speed to cool down.  
Configuration options: [Disabled] [Enabled]

## Execute Disable Bit [Enabled]

Allows you to enable or disable the No-Execution Page Protection Technology. Setting this item to [Disabled] forces the XD feature flag to always return to zero (0).  
Configuration options: [Disabled] [Enabled]



---

The following items appear only when you set the **CPU Ratio Setting** item to [Auto].

---

## Intel(R) SpeedStep (TM) Tech [Enabled]

When set to [Disabled], the CPU runs at its default speed. When set to [Enabled], the CPU speed is controlled by the operating system.  
Configuration options: [Disabled] [Enabled]

## 2.5.2 Chipset

The Chipset menu allows you to change the advanced chipset settings. Select an item then press <Enter> to display the sub-menu.

### North Bridge Configuration

#### *Memory Remap Feature [Enabled]*

Allows you to enable or disable the remapping of the overlapped PCI memory above the total physical memory. Enable this option only when you install 64-bit operating system.

Configuration options: [Disabled] [Enabled]

#### *Initiate Graphic Adapter [PEG/IGD]*

Allows you to decide which graphics controller to use as the primary boot device.

Configuration options: [IGD] [PCI/IGD] [PCI/PEG] [PEG/IGD] [PEG/PCI]

#### *IGD Graphics Mode Select [Enabled, XXMB]*

Allows you to select the size of system memory used by the internal graphics device.

Configuration options: [Disabled] [Enabled, 32MB] [Enabled, 64MB] [Enabled, 128MB]

#### *GTT Graphics Memory Size [No VT mode, 2MB]*

This item is not configurable.

#### *PAVP Function [Lite Mode]*

Allows you to set the GMCH Protected Audio Video Path (PAVP) BIOS support.

Configuration options: [Disabled] [Lite Mode] [Paranoid]

#### *DVMT Memory [256MB]*

Configuration options: [128MB] [256MB] [Maximum DVMT]



---

The [Maximum DVMT] option appears only when you install DIMM modules more than 1 GB.

---



This motherboard supports Intel® DVMT 5.0 Technology whose maximum graphics memory size in total varies with the system memory size in total and the operating system. Refer to the following table for details.

System Memory	Maximum Total Graphics Memory	
	Windows® XP	Windows® Vista™
1GB to < 1.5GB	512MB	552MB
1GB to < 2GB	768MB	808MB
2GB to < 3GB	1024MB	1320MB
3GB to < 4GB	—	1832MB
4GB and above	—	1849MB

## ME Subsystem Configuration

### ASF Support [Enabled]

Allows you to enable or disable the Alert Standard Format (ASF).

Configuration options: [Disabled] [Enabled].

### ME HECI Configuration

#### **ME-HECI [Enabled]**

When set to [Enabled], Host Embedded Communication Interface (HECI) provides an interface for the exchange of message between the host software and the ME firmware. Configuration options: [Disabled] [Enabled].

#### **ME-IDER [Disabled]**

Allows you to enable or disable the IDE Redirection interface by which the remote management console is able to direct the client PC to boot. Configuration options: [Disabled] [Enabled].

#### **ME-KT [Disabled]**

When set to [Enabled], the KT function helps redirect keyboard and POST message to the remote management console and thus facilitates the control of the client machine through the network. Configuration options: [Disabled] [Enabled].

### Configure Intel AMT Parameters

#### **ME BIOS Extension [Enabled]**

Allows you to enable or disable ME BIOS Extension.

Configuration options: [Enabled] [Disabled].



The Intel® Active Management Technology requires the Intel® AMT-enabled software. Also, the platform must be connected to a power source and an active LAN port.

#### **MEBx Setup Prompt [Hidden]**

Allows you to select to display or hide the ME BIOS Extension text during POST.

Configuration options: [Hidden] [Displayed].

#### **POST Delay (in Seconds) [None]**

Allows you to set the time delay during POST. Configuration options: [None] [1 Second] [3 Second] [Second]

## VE Subsystem Configuration

### VE-VECI [Disabled]

Allows you to enable or disable the Virtualization Embedded Controller Interface (VECI). Configuration options: [Disabled] [Enabled]

### Unhide All Physical HC [Enabled]

Allows you to choose hide or not hide all physical Host Controllers.  
Configuration options: [Disabled] [Enabled]

## 2.5.3 Onboard Devices Configuration

### High Definition Audio [Enabled]

Enables or disables the Azalia/AC'97 CODEC. Configuration options: [Enabled] [Disabled]

#### Front Panel Type [HD Audio]

Allows you to set the front panel audio connector (AAFP) mode to legacy AC'97 or high-definition audio depending on the audio standard that the front panel audio module supports. Configuration options: [AC97] [HD Audio]

### Intel Onboard LAN Controller [Enabled]

Allows you to enable or disable the onboard LAN controller.  
Configuration options: [Enabled] [Disabled]

#### Intel LAN Boot ROM [Disabled]

Allows you to enable or disable the Intel LAN Boot ROM in the onboard LAN controller. This item appears only when the Intel Onboard LAN Controller item is set to Enabled.  
Configuration options: [Disabled] [Enabled]

### Serial Port1 Address [3F8/IRQ4]

Allows you to select the Serial Port1 base address.  
Configuration options: [Disabled] [3F8/IRQ4] [3E8/IRQ4] [2E8/IRQ3]

### Serial Port2 Address [2F8/IRQ3]

Allows you to select the Serial Port2 base address.  
Configuration options: [Disabled] [2F8/IRQ3] [3E8/IRQ4] [2E8/IRQ3]

#### Serial Port2 Mode [Normal]

Allows you to select the serial port2 mode.  
Configuration options: [Normal] [IrDA] [ASK IR]

### Parallel Port Address [378]

Allows you to select the Parallel Port base addresses.  
Configuration options: [Disabled] [378] [278] [3BC]

### Parallel Port Mode [Normal]

Allows you to select the Parallel Port mode.  
Configuration options: [Normal] [EPP] [ECP] [EPP+ECP]



---

The following item appears only when the Parallel Port Mode item is set to **[ECP]**

---

#### **ECP Mode DMA Channel [DMA3]**

Appears only when the Parallel Port Mode is set to [ECP]. This item allows you to set the Parallel Port ECP DMA. Configuration options: [DMA0] [DMA1] [DMA3]

*Parallel Port IRQ [IRQ7]*

Configuration options: [IRQ5] [IRQ7]

## 2.5.4 USB Configuration

The items in this menu allows you to change the USB-related features. Select an item then press **<Enter>** to display the configuration options.



---

The **Module Version** and **USB Devices Enabled** items show the auto-detected values. If no USB device is detected, the item shows **None**.

---

### USB Functions [Enabled]

Enables or disables the USB functions. Configuration options: [Enabled] [Disabled]

### USB 2.0 Controller [Enabled]

Enables or disables the USB 2.0 Controller. Configuration options: [Enabled] [Disabled]

### BIOS EHCI Hand-Off [Enabled]

Allows you to enable the support for operating systems without an EHCI hand-off feature. Configuration options: [Disabled] [Enabled]

### Legacy USB Support [Auto]

Allows you to enable or disable support for Legacy USB storage devices, including USB flash drives and USB hard drives. Setting to **Auto** allows the system to detect the presence of USB devices at startup. If detected, the USB controller legacy mode is enabled. If no USB device is detected, the legacy USB support is disabled. Configuration options: [Disabled] [Enabled] [Auto]

### USB 2.0 Controller Mode [HiSpeed]

Allows you to configure the USB 2.0 controller in HiSpeed (480 Mbps) or Full Speed (12 Mbps). Configuration options: [FullSpeed] [HiSpeed]



---

The following items may only appear when a USB storage device is plugged.

---

## USB Mass Storage Device Configuration

### USB Mass Storage Reset Delay [20 Sec]

Allows you to set the maximum time that the BIOS waits for the USB storage device to initialize. Configuration options: [10 Sec] [20 Sec] [30 Sec] [40 Sec]

### Emulation Type [Auto]

Allows you to set the emulation type. Configuration options: [Auto] [Floppy] [Forced FDD] [Hard Disk] [CDROM]

## 2.5.5 PCI PnP

The **PCI PnP** menu items allow you to change the advanced settings for PCI/PnP devices. The menu includes setting IRQ and DMA channel resources for either PCI/PnP or legacy ISA devices, and setting the memory size block for legacy ISA devices.



---

Take caution when changing the settings of the PCI PnP menu items. Incorrect field values can cause the system to malfunction.

---

## Plug and Play O/S [No]

When set to [No], BIOS configures all the devices in the system. When set to [Yes] and if you install a Plug and Play operating system, the operating system configures the Plug and Play devices not required for boot. Configuration options: [No] [Yes]

## 2.5.6 TPM Configuration

The items in this menu allow you to set the TPM (Trusted Platform Module) features. Select an item then press <Enter> to display the configuration options.



---

The TPM Configuration item appears only when a TPM module is installed in this motherboard.

---

## TCG/TPM Support [Yes]

Allows you to enable or disable TCG/TPM setting. Configuration options: [Yes] [No]



---

The following items appear only when you set the TCG/TPM Support item to [Yes].

---

*TPM Enable / Disable Status [No State]*

The item is not configurable.

*TPM Owner Status [No State]*

The item is not configurable



## 2.6 Power menu

The **Power** menu items allow you to change the settings for the Advanced Configuration and Power Interface (ACPI) and the Advanced Power Management (APM). Select an item then press **<Enter>** to display the configuration options.

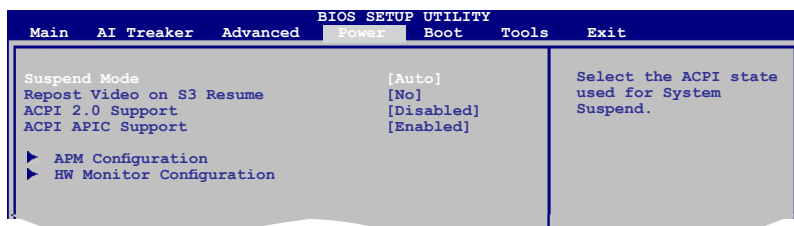

### 2.6.1 Suspend Mode [Auto]

Allows you to select the Advanced Configuration and Power Interface (ACPI) state to be used for system suspend. Configuration options: [S1 (POS) Only] [S3 Only] [Auto]

**[S1(POS) Only]** - Enables the system to enter the ACPI S1 (Power on Suspend) sleep state.

In S1 sleep state, the system appears suspended and stays in a low power mode. The system can be resumed at any time.

**[S3 Only]** - Enables the system to enter the ACPI S3 (Suspend to RAM) sleep state (default).

In S3 sleep state, the system appears to be off and consumes less power than in the S1 state. When signaled by a wake-up device or event, the system resumes to its working state exactly where it was left off.

**[Auto]** - Detected by OS.

### 2.6.2 Repost Video on S3 Resume [No]

Determines whether to invoke VGA BIOS POST on S3/STR resume.

Configuration options: [No] [Yes]

### 2.6.3 ACPI 2.0 Support [Disabled]

Allows you to add additional tables as per Advanced Configuration and Power Interface (ACPI) 2.0 specifications. Configuration options: [Disabled] [Enabled]

### 2.6.4 ACPI APIC Support [Enabled]

Allows you to enable or disable the Advanced Configuration and Power Interface (ACPI) support in the Application-Specific Integrated Circuit (ASIC). When set to **Enabled**, the ACPI APIC table pointer is included in the RSDT pointer list. Configuration options: [Disabled] [Enabled]

### 2.6.5 APM Configuration

#### Restore on AC Power Loss [Power Off]

When set to **Power Off**, the system goes into off state after an AC power loss. When set to **Power On**, the system goes on after an AC power loss. Configuration options: [Power On] [Power Off] [Last State]

#### Power On RTC Alarm [Disabled]

Allows you to enable or disable RTC to generate a wake event. When this item is set to **Enabled**, the items RTC Alarm Date, RTC Alarm Hour, RTC Alarm Minute, and RTC Alarm Second appear with set values. Configuration options: [Disabled] [Enabled]

## Power On By External Modems [Disabled]

This allows either settings of [Enabled] or [Disabled] for powering up the computer when the external modem receives a call while the computer is in Soft-off mode. Configuration options: [Disabled] [Enabled]



---

The computer cannot receive or transmit data until the computer and applications are fully running. Thus, connection cannot be made on the first try. Turning an external modem off and then back on while the computer is off causes an initialization string that turns the system power on.

---

## Power On By PME Devices [Disabled]

Allows you to enable or disable the PME to generate a wake event. Configuration options: [Disabled] [Enabled].

## Power On By PS/2 Keyboard [Disabled]

Allows you to use specific keys on the keyboard to turn on the system. This feature requires an ATX power supply that provides at least 1A on the +5VSB lead. Configuration options: [Disabled] [Space Bar] [Ctrl-Esc] [Power Key]

## Power On By PS/2 Mouse [Disabled]

When set to [Enabled], this parameter allows you to use the PS/2 mouse to turn on the system. This feature requires an ATX power supply that provides at least 1A on the +5VSB lead. Configuration options: [Disabled] [Enabled]

## 2.6.6 HW Monitor Configuration

### CPU Temperature [xxx°C/xxx°F]

### MB Temperature [xxx°C/xxx°F]

The onboard hardware monitor automatically detects and displays the CPU and motherboard temperatures. Select **Ignored** if you do not wish to display the detected temperatures.

### CPU/Chassis/Power Fan Speed [xxxxRPM] or [Ignored]

The onboard hardware monitor automatically detects and displays the CPU, chassis, and power fan speed in rotations per minute (RPM). If the fan is not connected to the motherboard, the field shows **N/A**. Select **Ignored** if you do not wish to display the detected speed.

### VCORE Voltage, 3.3V Voltage, 5V Voltage, 12V Voltage or [Ignored]

The onboard hardware monitor automatically detects the voltage output through the onboard voltage regulators. Select **Ignored** if you do not wish to display the detected voltage output.

## ASUS Advanced Q-Fan Control

### *Fan Profile [Silent]*

Allows you to select the fan profile. Configuration options: [Disabled] [Performance] [Optimal] [Silent] [Ultra Silent].



---

The option of "Ultra Silent" is for Intel® Core™2 processors only.

---

## 2.7 Boot menu

The **Boot** menu items allow you to change the system boot options. Select an item then press **<Enter>** to display the sub-menu.

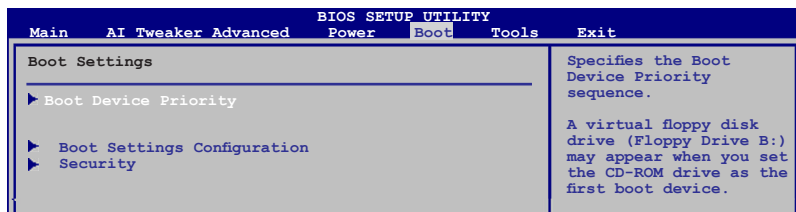

### 2.7.1 Boot Device Priority

#### 1st ~ xxth Boot Device

These items specify the boot device priority sequence from the available devices. The number of device items that appears on the screen depends on the number of devices installed in the system. Configuration options: [Removable Dev.] [Hard Drive] [ATAPI CD-ROM] [Disabled]

### 2.7.2 Boot Settings Configuration

#### Quick Boot [Enabled]

Enabling this item allows the BIOS to skip some power on self tests (POST) while booting to decrease the time needed to boot the system. When set to **[Disabled]**, BIOS performs all the POST items. Configuration options: [Disabled] [Enabled]

#### Full Screen Logo [Enabled]

This allows you to enable or disable the full screen logo display feature. Configuration options: [Disabled] [Enabled]



---

Set this item to **[Enabled]** to use the ASUS MyLogo 2™ feature.

---

#### AddOn ROM Display Mode [Force BIOS]

Sets the display mode for option ROM. Configuration options: [Force BIOS] [Keep Current]

#### Bootup Num-Lock [On]

Allows you to select the power-on state for the NumLock. Configuration options: [Off] [On]

#### Wait for 'F1' If Error [Enabled]

When set to **Enabled**, the system waits for the F1 key to be pressed when error occurs. Configuration options: [Disabled] [Enabled]

#### Hit 'DEL' Message Display [Enabled]

When set to **Enabled**, the system displays the message **Press DEL to run Setup** during POST. Configuration options: [Disabled] [Enabled]

### 2.7.3 Security

The **Security** menu items allow you to change the system security settings. Select an item then press **<Enter>** to display the configuration options.

#### Change Supervisor Password

Select this item to set or change the supervisor password. The **Supervisor Password** item on top of the screen shows the default **Not Installed**. After you set a password, this item shows **Installed**.

To set a Supervisor Password:

1. Select the **Change Supervisor Password** item then press **<Enter>**.
2. On the password box, key in a password containing up to six letters or numbers, or both, then press **<Enter>**.
3. Confirm the password when prompted. The message **Password Installed** appears after you successfully set your password.

To change the supervisor password, follow the same steps in setting a supervisor password.

To clear the supervisor password, select the **Change Supervisor Password** then press **<Enter>** twice. The message **Password uninstalled** appears.



---

If you forget your BIOS password, you can clear it by erasing the CMOS Real Time Clock (RTC) RAM. See section **1.6 Jumpers** for information on how to erase the RTC RAM.

---

After you have set a supervisor password, the other items appear to allow you to change other security settings.

#### User Access Level [Full Access]

This item allows you to select the access restriction to the Setup items.

Configuration options: [No Access] [View Only] [Limited] [Full Access]

**[No Access]** - prevents user access to the Setup utility.

**[View Only]** - allows access but does not allow change to any field.

**[Limited]** - allows changes only to selected fields, such as Date and Time.

**[Full Access]** - allows viewing and changing all the fields in the Setup utility.

#### Change User Password

Select this item to set or change the user password. The **User Password** item on top of the screen shows the default **Not Installed**. After you set a password, this item shows **Installed**.

To set a User Password:

1. Select the **Change User Password** item.
2. From the password box, type a password composed of at most six letters and/or numbers, then press **<Enter>**.
3. Confirm the password when prompted.

The message **Password Installed** appears after you set your password successfully.

To change the user password, follow the same steps in setting a user password.

## Clear User Password

Select this item to clear the user password.

## Password Check [Setup]

When set to [Setup], BIOS checks for user password when accessing the Setup utility. When set to [Always], BIOS checks for user password both when accessing Setup and booting the system. Configuration options: [Setup] [Always]

## SPI Lock Support [Disabled]

Allows you to enable or disable the SPI Lock function.  
Configuration options: [Disabled] [Enabled.]

## 2.8 Tools menu

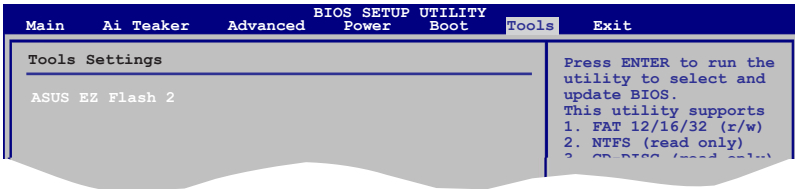

### ASUS EZ Flash 2

Allows you to run ASUS EZ Flash 2. When you press <OK>, a confirmation message appears. Use the left/right arrow key to select between [Yes] or [No], then press <OK> to confirm your choice.

## 2.9 Exit menu

The **Exit** menu items allow you to load the optimal or failsafe default values for the BIOS items, and save or discard your changes to the BIOS items.

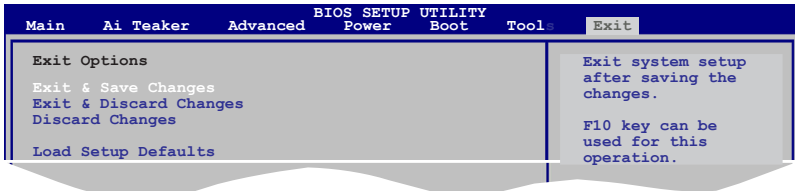

Pressing <Esc> does not immediately exit this menu. Select one of the options from this menu or <F10> from the legend bar to exit.