

Safety 1st[®]

Your child comes first.™

Instruction Manual & User Guide Melody Garden 2 in 1 Activity Centre



An IGC Dorel brand

Please read this manual in its entirety before assembling the product and follow all instructions contained herein. Please retain instruction manual for future reference.

Illustrations are representative only.
Design and style may vary.

BEFORE ASSEMBLING THIS WALKER,
PLEASE READ AND UNDERSTAND THE INSTRUCTIONS AND ENSURE THAT THEY ARE FOLLOWED AT ALL
TIMES. INCORRECT ASSEMBLY COULD MAKE THE WALKER UNSAFE.
RETAIN THESE INSTRUCTIONS IN A SAFE PLACE FOR FUTURE REFERENCE.

WARNINGS

- **WARNING** - **NEVER** leave child unattended and always keep child in view while using walker.
- **WARNING- STAIR HAZARD:** avoid serious injury or death. Block stairs and steps securely before using walker.
- Use only on flat surfaces free of objects that could cause the unit to tip over. Never use near stairs, thresholds, hills, roadways or pools.
- To avoid burns, keep the child away from hot liquids, stoves, radiators, space heaters, fireplaces, barbeques and similar hazards.
- Prepare rooms to prevent collisions with glass, windows and furniture.
- Do not carry or adjust the walker while a child is in it.
- Do not lift the walker by the tray, toy tray or toys.
- To reduce the chance of the child slipping out of the seat, check that both feet are touching the floor.
- This walker is intended for one child only.
- Do not suspend strings, such as hood strings or pacifier cords, on the walker or attach strings to toys. String can wrap around a child's neck and cause choking.
- The walker & toys must be assembled by an adult.
- Check that the walker is fully erected and that the frame has locked in place before placing a child in the walker.
- Discontinue use of the walker when the child can stand unaided or walk unassisted.

WARNINGS (cont)

- Regularly inspect the walker for any part that is loose, broken, torn or missing. Attend to the problem as soon as it is noticed.
- Do not use until baby can sit up by their self.
- To avoid danger of suffocation, keep any plastic bags away from babies and children. Plastic bags can block nose and mouth and prevent breathing. Bags are not toys. Please dispose of waste packaging thoughtfully.
- Only use the walker if your child can support their body weight with their legs, weight between **6kgs** and **12kgs**, and is less than **80cms** high.
- Do not use the walker if it is damaged or broken.
- Clean the friction strips regularly with a damp cloth to maintain stopping performance.
- This product is not intended for commercial use.

Component list:

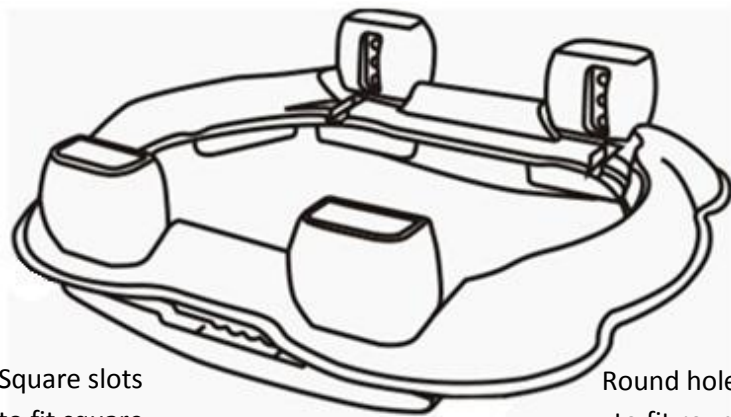

Square slots
to fit square
pins

Round holes
to fit round
pins

Base

Square pin close up

Round pin close up

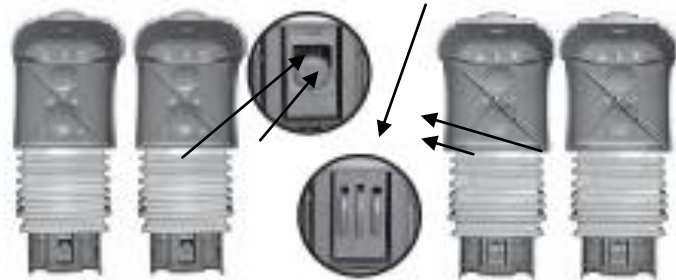

Legs x 4



Large nuts x 4

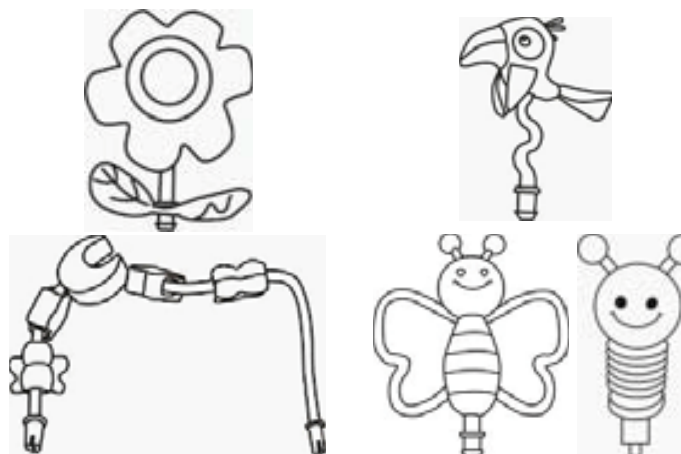

Toys x 5

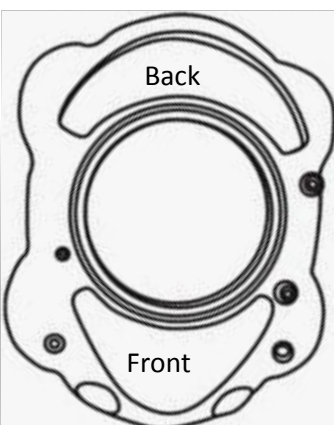

Tray

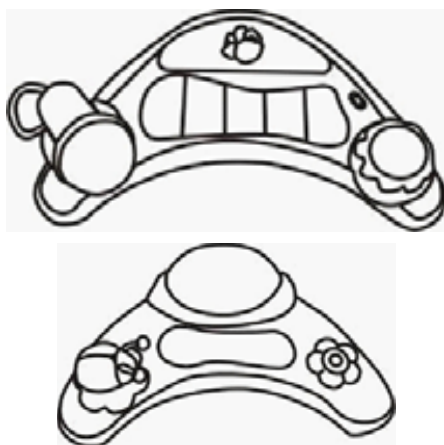

Toy trays x 2

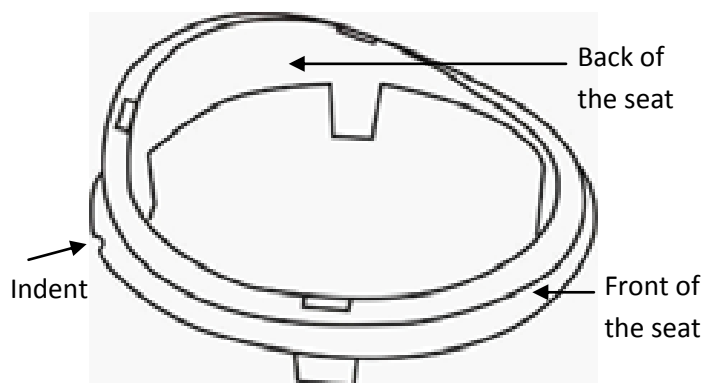

Seat Ring

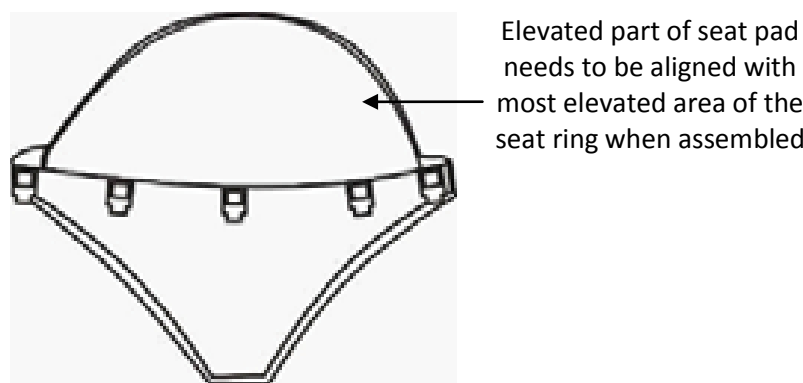

Seat Pad

Elevated part of seat pad
needs to be aligned with
most elevated area of the
seat ring when assembled

Assembling your Activity Centre

ASSEMBLING THE ACTIVITY CENTRE

- Press each leg button and insert the leg firmly into the mounting hole at the base as per **Figure 1**.

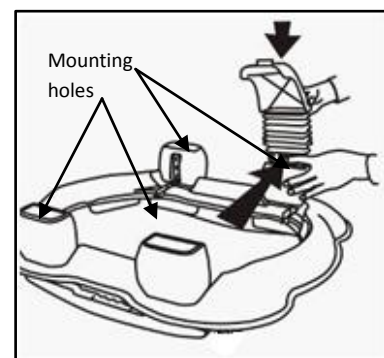

Figure 1

- Legs with square pins enter the square holes at the base, as per **Figure 2**.
- Legs with round pins enter the round holes at the base, as per **Figure 3**.



Figure 2

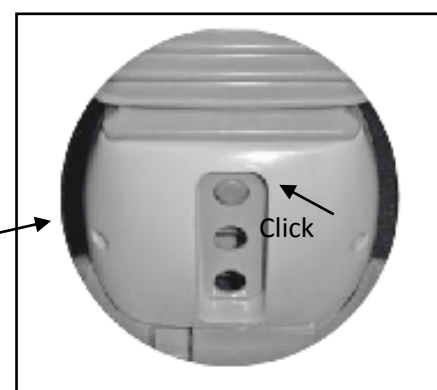
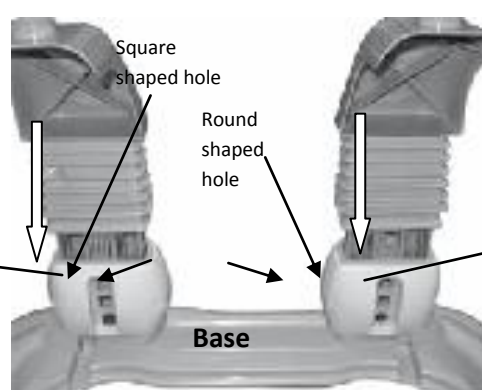

Figure 3

- Connect the legs to the upper tray, as per **Figure 4** so that the screws on the upper tray stick through the holes on the top of the legs.
- Put the assembly on its side, as per **Figure 5** and connect the four large plastic nuts on the protruding threads by tightening them clockwise, as per **Figure 6** and **Figure 7**.

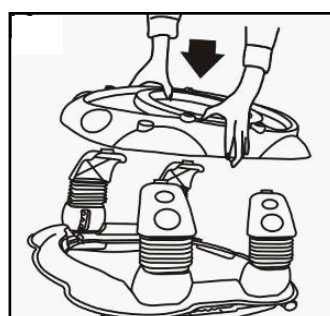

Figure 4

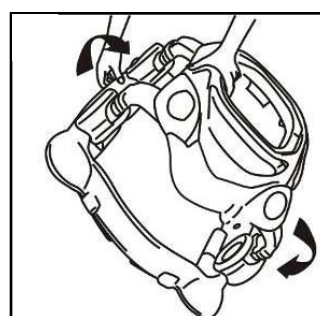

Figure 5

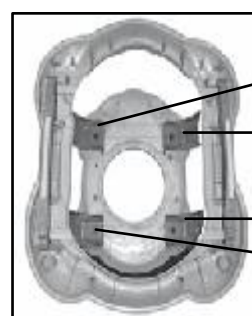

Figure 6



Figure 7

Assembling your Activity Centre (cont.)

- Inserting the tabs on the seat pad into slots located around the seat ring, as per **Figure 8**.
- Slide tabs through holes and insert the seat to the upper tray, as per **Figure 9**.

Elevated side of seat pad fabric must match with elevated side of seat ring

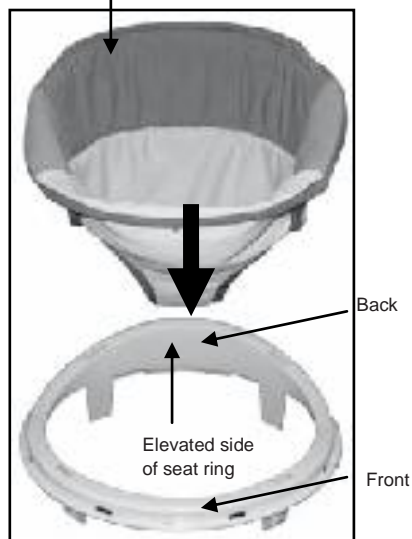

Figure 8

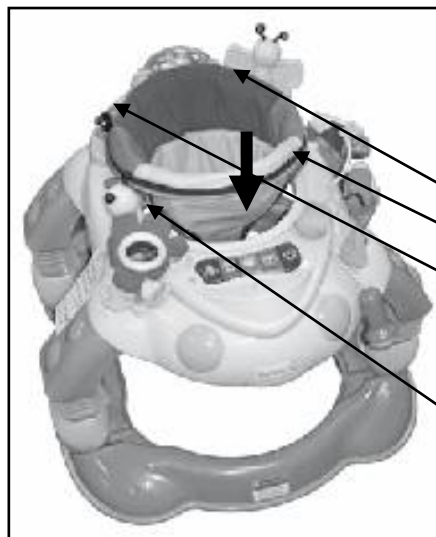
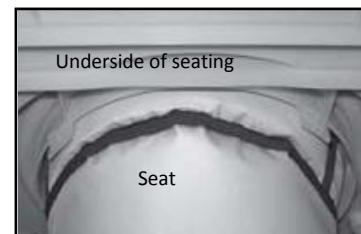
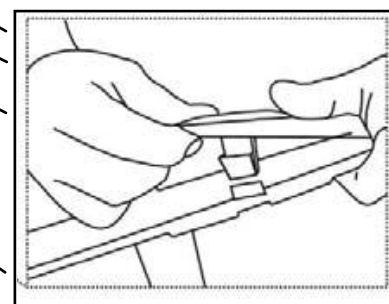

Figure 9



Make sure the four tabs found on the 'white' seat ring are secured under the tray



TO ATTACH THE TOYS

🔧 The toy tray requires two AA batteries (not included).

- Use a Philips head screwdriver to unfasten battery cover, insert batteries and replace cover as per **Figure 10**.
- Insert and snap the toy trays into upper tray at designated cavities as per **Figure 11**.

🔧 To release the toy tray lay the activity centre upside down and press the yellow tabs underneath the toy tray firmly.

Assembling your Activity Centre (cont.)

- ⚠ Battery removal and replacement must be carried out by an adult. Batteries should be inserted with the correct polarity, observing (+) and (-) marks on the batteries and product.
- ⚠ Only use batteries of the same or equivalent type to those recommended.
- ⚠ Avoid short-circuiting the terminals in the battery compartment, or the battery terminals.
- ⚠ Do not mix old (used) and new batteries, or batteries of different types, for example: alkaline and rechargeable.
- ⚠ Remove exhausted batteries from walker. Battery leakage and corrosion can damage this walker.
- ⚠ Remove the batteries if storing product for long periods of non-use.
- ⚠ Dispose of exhausted batteries, and never dispose of batteries in a fire.
- ⚠ Never attempt to recharge non-rechargeable batteries.

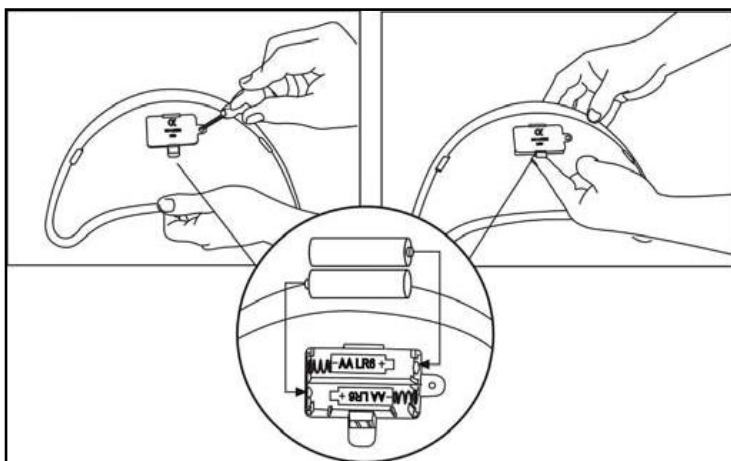

Figure 10

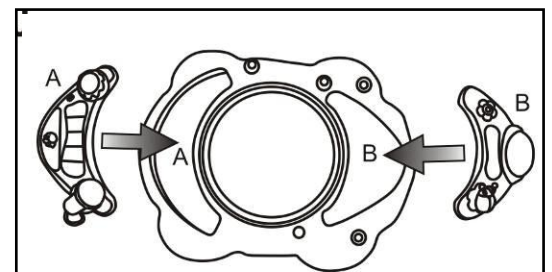

Figure 11

Assembling your Activity Centre (cont.)

- Insert toys into the designated cavities as per **Figure 12**, and be sure they are securely connected.

🔑 Toy B comes with a small 'C' shaped plastic part which securely holds the toy underneath the main tray.

- Place the 'C' shaped clip at the end of Toy B to secure it in its designated hole, as per **Figure 13**.

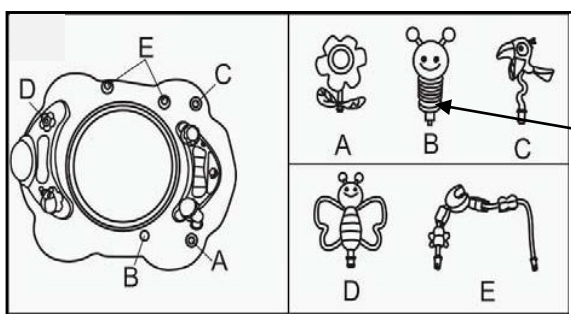

Figure 12

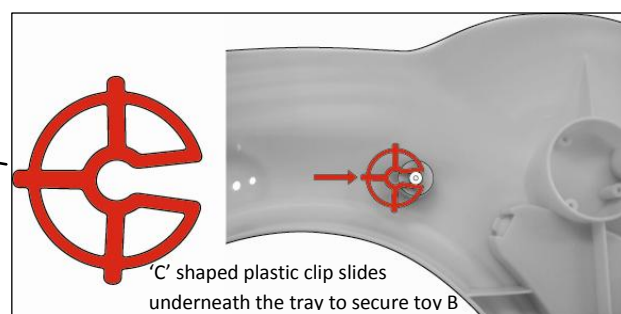

Figure 13

TO USE THE MUSIC FUNCTION

- Switch the music function on by activating the 'on/off' switch.
- Select the multi-music by pushing the Bee to the left and right, as per **Figure 14**.
- The keyboards and drum button also plays various music when pressed.

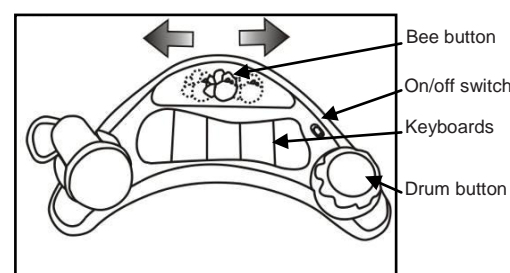

Figure 14

TO ADJUST THE SEAT HEIGHT

- 🔑 The activity centre can be adjusted to 3 different height levels.
- 🔧 Make sure all legs are adjusted to the same height level when adjusting the height of the seat.
- 🔧 Adjust one leg at a time.

- Press leg button located on each leg, as per **Figure 15 (1)**.
- Raise or lower the leg to the desired position, as per **Figure 15 (2)**.
- Make sure each leg securely clicks into the slot at the mounting hole base.

Assembling your Activity Centre (cont.)

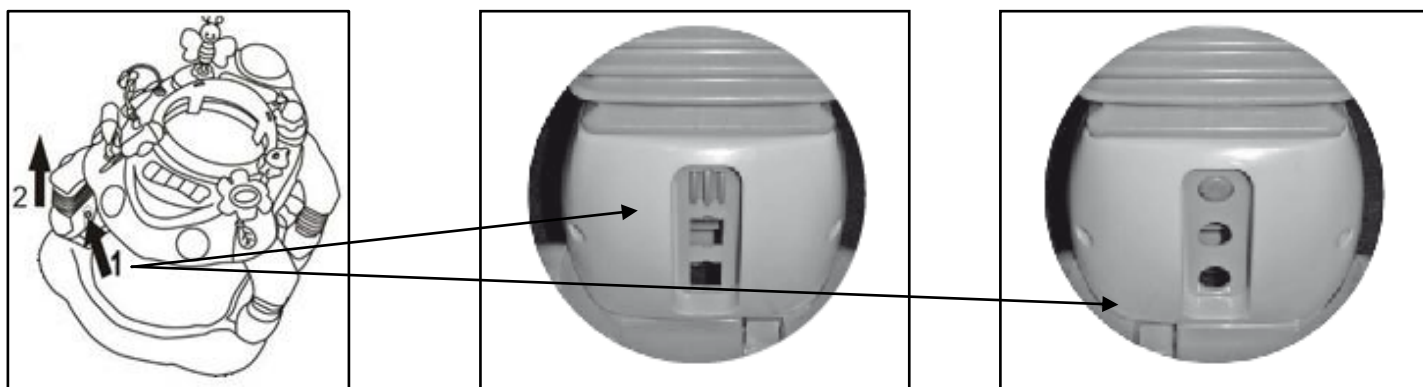

Figure 15

TO USE THE ROCKING FUNCTION

- Pull the rocking bar down, as per **Figure 16**.

- To retract the rocking bar press the buttons on each leg's base and push the rocking bar up, as per **Figure 17**.
- To stop rocking action pull out both stoppers at the rocking bar and extend fully, as per **Figure 18**.

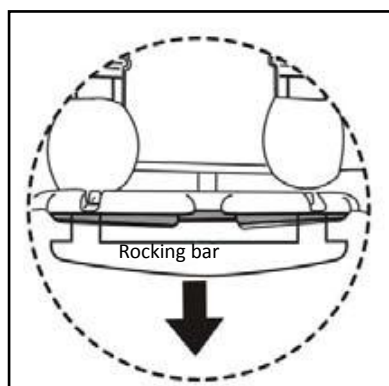

Figure 16

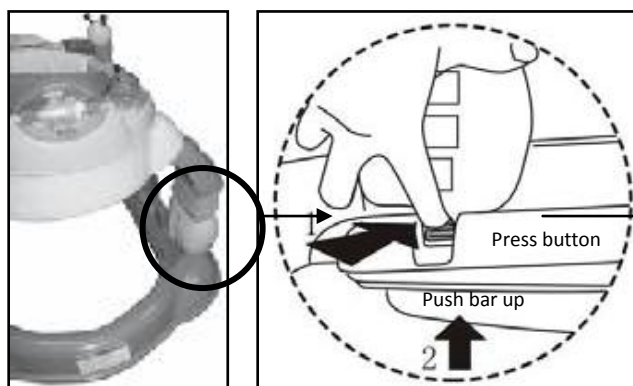

Figure 17

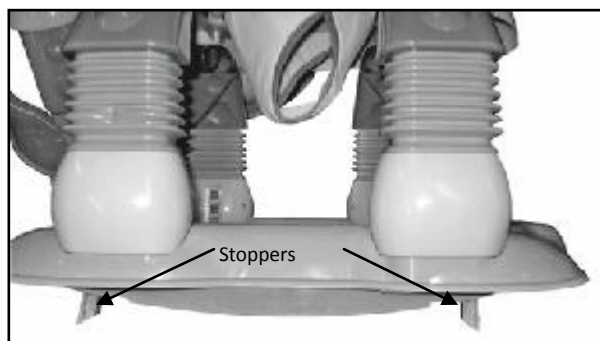

Figure 18

- To stop rocking, pull stop.
- To start rocking, push stopper inside.

Assembling your Activity Centre (cont.)

TO SWIVEL THE SEAT

- Line the red knob with the indent in the white seat ring, as per **Figure 19**.
- Lift and rotate the red knob in position, as per **Figure 20**.

✦ To unlock the swivel seat, rotate red knob in position, as per **Figure 21**.

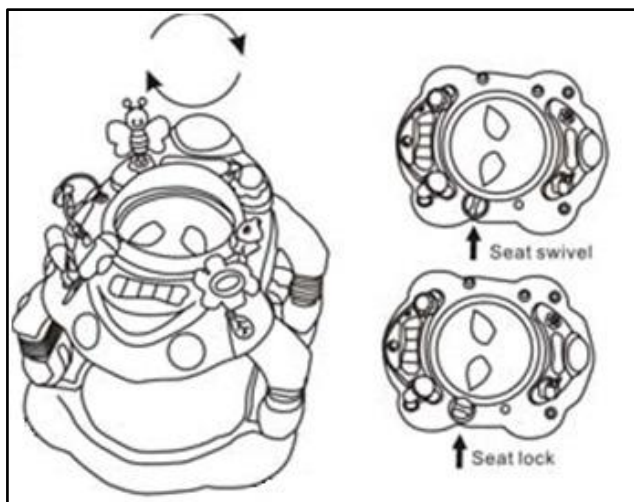

Figure 19

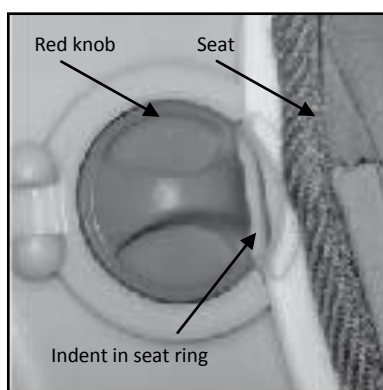

Figure 20
(seat in un-locked position)

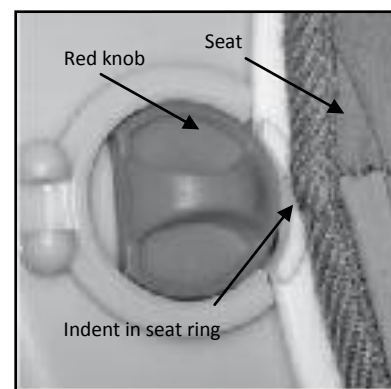

Figure 21
(seat in locked position)

Notes

**Please tape or staple your receipt
here for safekeeping and future reference.**

Product care and maintenance

- Always store the unit in a clean and dry place.
- Do not use abrasives or detergents on the unit's surfaces.
- Scuff marks can be removed with mild soap and warm water. Dry with a soft towel.
- Regularly check all bolts to ensure they are tight.
- Damaged components should be replaced as required.
- Replacement parts are available from the IGC Dorel Customer Service Department.
- Clean the friction strips regularly with a damp cloth to maintain stopping performance.

Customer service

Please contact our Customer Service Department if you experience a problem with this product or require assistance:

AUSTRALIAN CUSTOMERS

Email	sales@igcdorel.com.au
Web	www.igcdorel.com.au
Phone 1	(03) 8311 5300
Address	655-685 Somerville Road Sunshine West, Vic, 3020
Phone 2	1300 809 526 (local call cost)
Hours	8:30 am – 4:30 pm, Monday to Friday
Postal	IGC Dorel Pty Ltd P.O. Box 1260 Sunshine West, Victoria, 3020 Australia

NEW ZEALAND CUSTOMERS

Email	customerservice@igcdorel.co.nz
Web	www.igcdorel.com.au
Phone 1	(09) 276 1040
Address	7 A Hotunui Drive, Mt Wellington Auckland, 1060.
Phone 2	0800 628 000 (Toll Free)
Hours	9:00 am – 4:00 pm, Monday to Friday
Postal	IGC Dorel New Zealand P.O. Box 82377 Highland Park Mt Wellington New Zealand

Guarantee

This product carries a twelve month guarantee to rectify manufacturing defects. It does not cover problems arising from accidental damage or product misuse. Specifications are subject to change without notice.

Copy or reproduction without permission is prohibited.

© 2010 IGC Dorel Pty Ltd. All Rights Reserved. www.igcdorel.com.au