

BK PRECISION[®]

Model 1900, 1901, 1902

Switching DC Power Supply

INSTRUCTION MANUAL

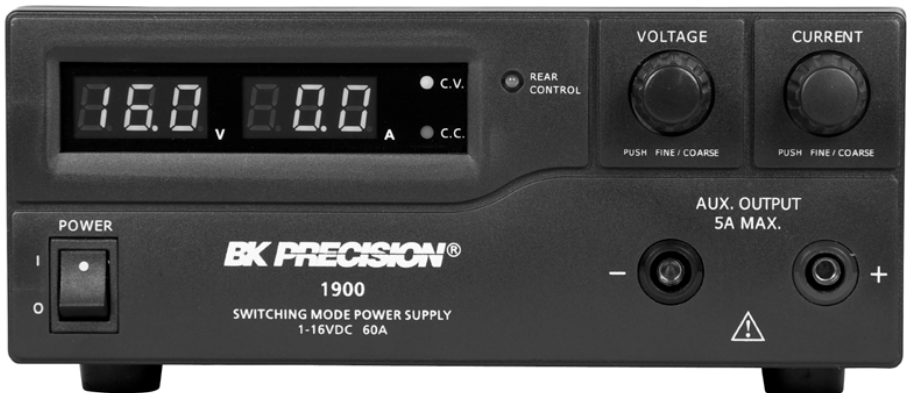

1 Safety Summary

The following safety precautions apply to both operating and maintenance personnel and must be observed during all phases of operation, service, and repair of this instrument. Before applying power, follow the installation instructions and become familiar with the operating instructions for this instrument.

GROUND THE INSTRUMENT

To minimize shock hazard, the instrument chassis and cabinet must be connected to an electrical ground. This instrument is grounded through the ground conductor of the supplied, three-conductor ac power cable. The power cable must be plugged into an approved three-conductor electrical outlet. Do not alter the ground connection. Without the protective ground connection, all accessible conductive parts (including control knobs) can render an electric shock. The power jack and mating plug of the power cable meet IEC safety standards.

DO NOT OPERATE IN AN EXPLOSIVE ATMOSPHERE

Do not operate the instrument in the presence of flammable gases or fumes. Operation of any electrical instrument in such an environment constitutes a definite safety hazard.

KEEP AWAY FROM LIVE CIRCUITS

Instrument covers must not be removed by operating personnel. Component replacement and internal adjustments must be made by qualified maintenance personnel. Disconnect the power cord before removing the instrument covers and replacing components. Under certain conditions, even with the power cable removed, dangerous voltages may exist. To avoid injuries, always disconnect power and discharge circuits before touching them.

DO NOT SERVICE OR ADJUST ALONE

Do not attempt any internal service or adjustment unless another person, capable of rendering first aid and resuscitation, is present.

DO NOT SUBSTITUTE PARTS OR MODIFY THE INSTRUMENT

Do not install substitute parts or perform any unauthorized modifications to this instrument. Return the instrument to B&K Precision for service and repair to ensure that safety features are maintained.

WARNINGS AND CAUTIONS

WARNING and **CAUTION** statements, such as the following examples, denote a hazard and appear throughout this manual. Follow all instructions contained in these statements.

A **WARNING** statement calls attention to an operating procedure, practice, or condition, which, if not followed correctly, could result in injury or death to personnel.

A **CAUTION** statement calls attention to an operating procedure, practice, or condition, which, if not followed correctly, could result in damage to or destruction of parts or the entire product.

WARNING: *Do not alter the ground connection. Without the protective ground connection, all accessible conductive parts (including control knobs) can render an electric shock. The power jack and mating plug of the power cable meet IEC safety standards.*

WARNING: *To avoid electrical shock hazard, disconnect power cord before removing covers. Refer servicing to qualified personnel.*

CAUTION: *Before connecting the line cord to the AC mains, check the rear panel AC line voltage indicator. Applying a line voltage other than the indicated voltage can destroy the AC line fuses. For continued fire protection, replace fuses only with those of the specified voltage and current ratings.*

CAUTION: *This product uses components which can be damaged by electrostatic discharge (ESD). To avoid damage, be sure to follow proper procedures for handling, storing and transporting parts and subassemblies which contain ESD-sensitive components.*

SAFETY SYMBOLS



This symbol on an instrument indicates that the user should refer to the operating instructions located in the manual.

Certification

We certify that this product met its published specifications at time of shipment from the factory.

Compliance Statements

Disposal of Old Electrical & Electronic Equipment (Applicable in the European Union and other European countries with separate collection systems)



This product is subject to Directive 2002/96/EC of the European Parliament and the Council of the European Union on waste electrical and electronic equipment (WEEE), and in jurisdictions adopting that Directive, is marked as being put on the market after August 13, 2005, and should not be disposed of as unsorted municipal waste. Please utilize your local WEEE collection facilities in the disposition of this product and otherwise observe all applicable requirements.

Contents

1	Safety Summary	1
2	Introduction	5
3	Controls and Indicators.....	6
3.1	Front Panel.....	6
3.2	Rear Panel	7
4	Operating Instructions.....	8
4.1	Using the Power Supply	9
4.1.1	Connection	9
4.1.2	Self Test Sequence	9
4.1.3	Control Knobs.....	11
4.1.4	Using Both Main and Auxiliary Outputs.....	12
4.2	Control Modes	12
4.2.1	Normal Mode	13
4.2.2	Preset Mode.....	13
4.2.3	Set Mode.....	14
4.2.4	Remote Control Mode	15
4.3	Remote Sensing.....	15
4.3.1	Connection	15
4.3.2	Disconnection.....	16
4.4	Remote Control.....	16
4.4.1	Voltage Remote Control.....	16
4.4.2	Enable and Disable the Output	20
5	Faults and Troubleshooting	21
5.1	OVP: Overvoltage Protection	21
5.2	OTP: Overtemperature Protection.....	22
5.3	OLP: Overload Protection.....	22
5.4	Fuse Replacement.....	23
6	Specifications	24
7	Certification	26
8	Service Information	27
9	Limited Two-Year Warranty.....	28

2 Introduction

B&K Precision models 1900, 1901, and 1902 are laboratory grade switching mode DC power supplies with high current output in a small form factor and lightweight package. The 1900 Series provide different configurations of high output voltage or high output current and make setting voltage and current levels fast and precise through its dual action, course/fine rotary encoder control. In addition to its constant voltage (CV) and constant current (CC) modes, the high efficiency DC power supply offers a unique solution with its preset and analog remote control modes. Save up to three different presets of voltage and current values for quick recall. The analog remote control function allows the output power, voltage, and current to be adjusted without touching the front panel of the power supply. A remote sensing terminal (model 1900 only) is also available for use to compensate for voltage drop across load leads. These features make the 1900 Series suitable for a wide range of applications including production testing, telecommunications, R&D, service, and university labs.

Features

- Automatic CV/CC crossover operation
- Up to 60 A output current
- Lightweight and compact
- Rotary encoder control for precise voltage and current setting
- 3 user-defined voltage and current presets
- Analog remote control function
- Remote sensing terminal (model 1900 only)
- Overvoltage, overtemperature, and overload protection
- Front panel auxiliary output

3 Controls and Indicators

3.1 Front Panel

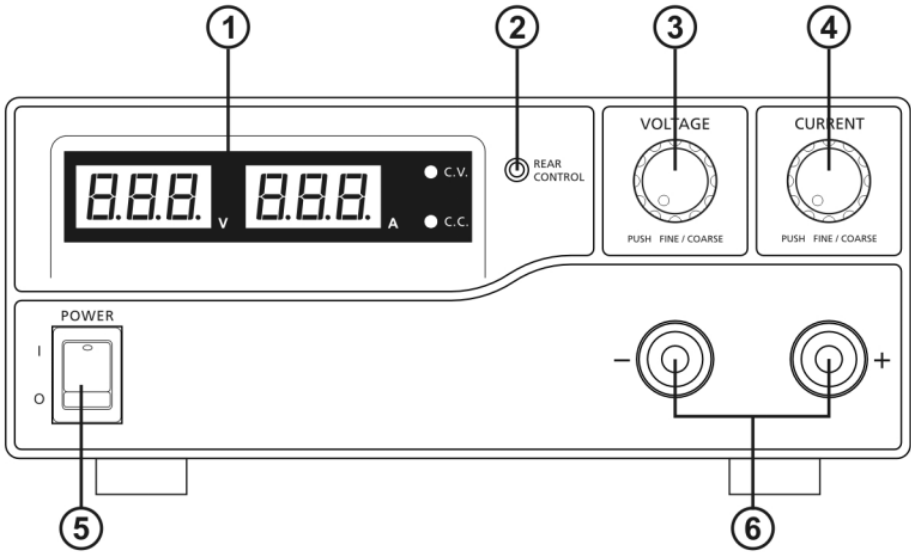

Figure 1 - Front Panel

- (1) LED panel meter display with CV/CC indicator
- (2) Rear Control Indicator (lights up when using Preset/Remote Control/Set mode)
- (3) Output Voltage Control Knob (control main and auxiliary output voltage)
- (4) Output Current Control Knob (control main and auxiliary output current limit)
- (5) Power ON/OFF Switch
- (6) Auxiliary Output Terminal (max 5 A)

Note: Please see Section 4.1.4 for more details on using both main and auxiliary output terminals together.

3.2 Rear Panel

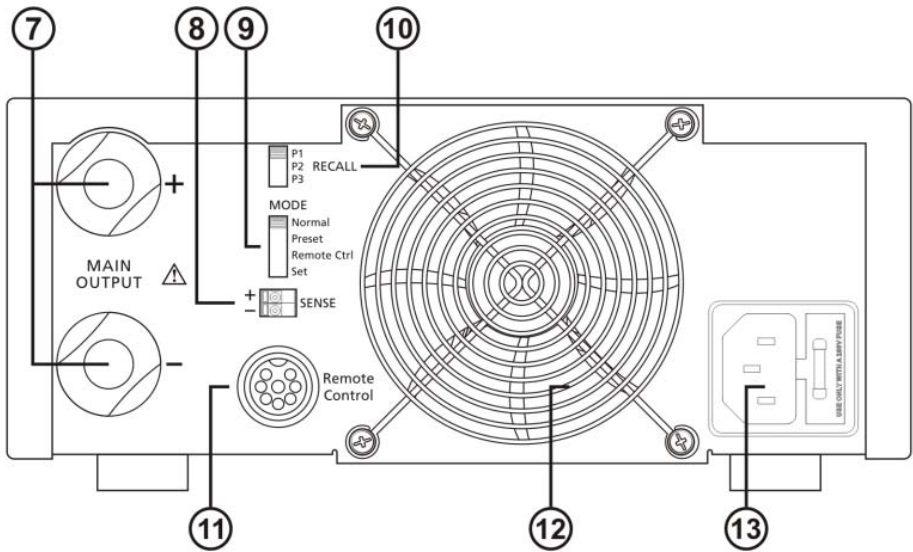

Figure 2 - Rear Panel

(7) Main Output Terminal (max 60 A for 1900 / 30 A for 1901 / 15 A for 1902)

Note: Please see Section 4.1.4 for more details on using both main and auxiliary output terminals together.

(8) Remote Sensing Terminal (model 1900 only)

(9) Mode Selection Switch (Normal, Preset, Remote Control, Set Modes)

(10) Recall Preset Selection Switch

(11) Analog Remote Control Terminal

(12) Cooling Fan Air Intake Grille

(13) AC Input Plug and Fuse Compartment

4 Operating Instructions

Safety Precautions

- Never short the remote sensing terminal.
- This power supply is for indoor use only.
- Do not expose the power supply to sun, high humidity, or dusty environments.
- Never remove the metal cover of the power supply while AC power is connected.
- Never touch the unit when your hands are wet.
- Never block the ventilation slots and cooling fan air intake window.
- Never attempt to repair the power supply. Incorrect re-assembly may result in a risk of electric shock or fire.
- Never use the power supply for a load requiring higher current than the designed value. Otherwise it may damage the power supply.
- Place the power supply on a flat surface with sufficient clearance and dry, dust-free surroundings for ventilation.

This series has three models with different output voltage and current ranges. Make sure you have purchased the correct one.

Model Number	Output Voltage Range	Total Rated Current
1900	1 – 16 V	0 – 60 A
1901	1 – 32 V	0 – 30 A
1902	1 – 60 V	0 – 15 A

Table 1 - Model Table

4.1 Using the Power Supply

4.1.1 Connection





To connect the equipment to the power supply, follow the steps below.

1. Check the rating label of the power supply and confirm that it complies with your AC mains voltage.
2. Connect the power supply to the AC mains using the provided power cord and make sure the Mode Selection Switch is in the Normal position.
3. Hook up the red (+) terminal to the positive polarity input of the equipment and the black (-) terminal to the negative polarity input of the equipment.
4. Switch on the power supply first. The panel meter and green CV indicator should light up again.
5. Switch on the equipment. The panel meter and green CV indicator should still remain green.
6. When an operation is finished, switch off the equipment first and then switch off the power supply.

4.1.2 Self Test Sequence

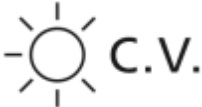
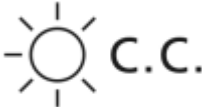
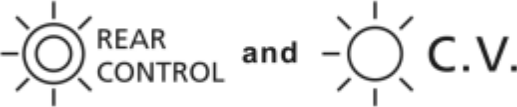
The power supply will perform a series of self checks when it is switched on. The table below shows the self test sequence.

Front Panel Display	Test
	To show software version

Front Panel Display	Test
	Segment check
	C.V. indicator check
	C.C. indicator check
	Rear control indicator check
	Return to C.V.
	Start power supply checks
	Overvoltage protection check
	Overload protection check



Front Panel Display	Test
	Overtemperature protection check
	Fan check
	Output off (remote control mode)

Table 2 - Self Test Sequence

The LED and other indicators on the front panel will be turned on. When the cooling fan is being checked, a loud fan noise can be heard.

After the self checks, the CV, V, and A LED indicators are lit up displaying voltage and 0.0 current. To find out about the set CC current level, just turn the current control knob one click in either direction. The current display returns to 0.0 after a few seconds.

4.1.3 Control Knobs

The rotary encoder control knobs have fine and coarse tuning with clicking movement.

Push the knobs to toggle between coarse and fine tuning. You will notice the subtle change in brightness of LED.

Adjust the knobs to your desired values through coarse and fine tuning. The display will resume its normal brightness after a few seconds to confirm your adjustment.

4.1.4 Using Both Main and Auxiliary Outputs

The power supply has a main output in the rear and an auxiliary output in the front that can be used separately or together.

The main and auxiliary output both share the same voltage and current control knobs and will output the same voltage and current up to the maximum output ratings of the power supply and terminals. When using both the main and auxiliary outputs together, the power supply will automatically total the currents supplied to both terminals up to the current limit of the power supply and show the total current on the display.

For example, setting the voltage and current outputs for model 1900 (1-16 V, 0-60 A) to 16 V and 60 A would output 16 V at both main and auxiliary terminals and allow you to draw up to a total of 60 A between the two terminals. If there is a 5 A load at the auxiliary terminal, the most current you can draw from the main output is 55 A.

If the power supply reaches its set current limit at any time, the power supply will go into CC mode and the loads together will draw up to the total value of the current limit. Distribution of current between the main and auxiliary terminals will vary depending on the loads.

Note: 1900: Total rated current (Aux. + Main) is 60 A
1901: Total rated current (Aux. + Main) is 30 A
1902: Total rated current (Aux. + Main) is 15 A

4.2 Control Modes

There are four different control modes for the power supply:

- Normal
- Preset
- Set
- Remote Control

To select a mode, slide the Mode Selection Switch on the rear of the unit.

Note: The power supply is factory preset to Normal Mode with maximum current level.

4.2.1 Normal Mode

This is the factory preset mode and the power supply output voltage and current are controlled by the dual action dial knobs.

Push the knobs to toggle the coarse and fine tuning. You will notice the subtle change in brightness of LED.

Adjust the knobs to your desired values through coarse and fine tuning. To check the preset current level, turn the Current Knob lightly in any direction.

The display will resume its normal brightness after a few seconds to confirm your adjustment.

4.2.2 Preset Mode

In this mode, the Rear Control light is ON to indicate panel voltage and current controls are deactivated.

There are three presets P1/P2/P3 on the Recall Selection Switch. The factory preset values are shown in Table 3.

The user can also set their own output voltage and current using Set Mode. Please refer to Section 4.2.3 for details.

Recall No.	Output Voltage	Output Current
P1	5 V	Maximum
P2	13.8 V	Maximum
P3	Model 1900: 15 V Model 1901: 25 V Model 1902: 55 V	Maximum

Table 3 - Default Presets

4.2.3 Set Mode

First, enter Set Mode by pushing Mode Selection Switch to “Set” position.

To define the preset output P1/P2/P3

1. Select the Recall Switch to the position you want to set: P1, P2, or P3.
2. Adjust the front panel voltage control knob to set your desired voltage value.
3. Adjust the front panel current control knob to set your desired current limit value.
4. Repeat the procedure for remaining presets P1, P2, or P3 if desired.
5. Move Mode Selection Switch from “Set” to “Preset” position to confirm your settings.

To reset the unit back to factory settings

1. Turn OFF the power supply.
2. Push and hold both front panel voltage and current control knobs at the same time.
3. Turn ON the power supply.
4. Release front panel voltage and current control knobs.

Note:

- All the set values in the presets will be saved even after the power supply has been turned off.
- Always check output voltage of Presets before connecting to load.
- To check the preset values, move Mode Selection Switch to “Preset” position.
- Move the Recall Switch to P1, P2, or P3.
- The voltage and current settings of corresponding presets P1, P2, or P3 will be shown on the panel meters.

4.2.4 Analog Remote Control Mode

Select this mode to control the output voltage and current by Remote Control Connector. Please refer to Section 4.4 for more details.

4.3 Remote Sensing

(Model 1900 Only)

WARNING: Never short the remote sensing terminal.

Never connect the remote sensing terminal in reverse polarity.

Always disconnect the remote sensing terminal first after use.

4.3.1 Connection

1. Make the power connections between power supply and equipment.
2. Check and make sure the power connections are secure.
3. Then make connections between Remote Sense Terminal and equipment.

Figure 3 shows typical connection between power supply and device for remote sense operation.

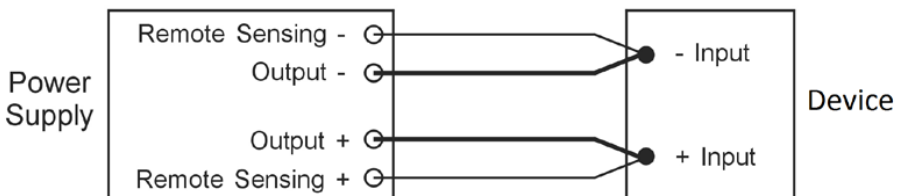

Figure 3 - Remote Sense Connection

The remote sensing wire gauge should be at least 22AWG.

4.3.2 Disconnection

WARNING: Wrong disconnect sequence will damage the power supply.

1. Disconnect the remote sensing connections.
2. Disconnect the power connections between the power supply and equipment.

4.4 Analog Remote Control

There are two methods to remote control voltage and current.

Note: Both methods require the remote control connector plug to be set up in order for analog remote control mode to be functional; otherwise the unit will be in CC mode all the time.

4.4.1 Voltage Remote Control

Set up the provided remote connector plug.

- (a) Remove the black portion of the remote control connector plug by removing the screw as shown in Figure 4.



Figure 4 - Remote Control Connector

- (b) Solder 5 wires (22AWG) to pins 1, 2, 3, 4, and 5 of pin plug. Refer to Figure 5 for pin numbers.

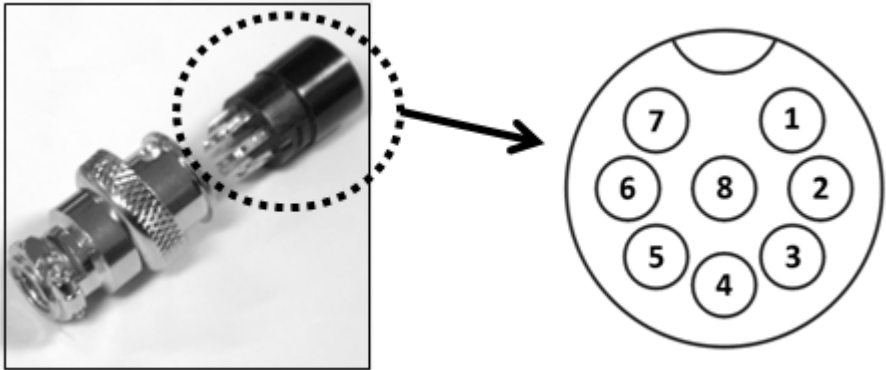

Figure 5 - Pin Numbers

- (c) Make sure the load is disconnected and the power supply is OFF.
- (d) Plug the remote connector plug into the analog remote control terminal of the power supply.
- (e) Secure the remote connector plug to the terminal socket by locking the connector ring (Figure 6).

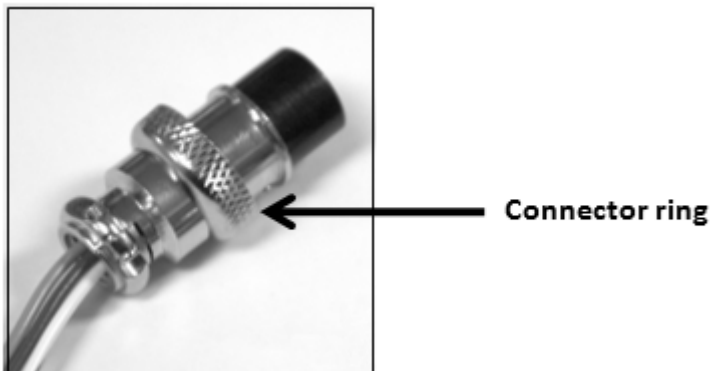

Figure 6 - Connector Ring

Then, you can choose either method A or B below to use the analog remote control feature.

Method A: Using Two External Variable DC Voltage Sources

PIN	FUNCTIONS	REMARKS
1	Internal DC +5 V	Less than 50 mA
2	Voltage Adjust	0 – 5 V
3	Current Adjust	0 – 5 V
4	Ground	
5	Output OFF	Short to Ground
6	N/A	
7	N/A	
8	N/A	

Table 4 – Remote Connector Plug Pin Assignment for External Variable Voltage Sources

A variable external DC voltage source of 0 – 5 V is fed into the analog remote control terminal to adjust the output voltage level of both Main and Auxiliary output.

WARNING: Do not input higher than 5 V, otherwise the overvoltage protection (OVP) will be triggered.

1. Make sure the load is disconnected and the power supply is OFF.
2. Connect pin 2 to positive polarity of first external voltage source and pin 4 to negative polarity of first external voltage source.
3. Connect pin 3 to positive polarity of second external voltage source and pin 4 to negative polarity of second external voltage source.
4. Turn the remote control ON/OFF switch to ON position.

5. Switch on the power supply.
6. Check the output voltage range of the power supply by varying the external voltage source for voltage adjustment from 0 to 5 V.
7. Short circuit the main output with an 8AWG gauge wire and check the display for CC setting by varying the external voltage source for current adjustment from 0 to 5 V.
8. Switch off the power supply.

Method B: Using Two 5 k Ω Variable Resistors

1. Make sure the load is disconnected and the power supply is OFF.
2. Prepare two 5 k Ω variable resistors and connect wires from pins 1, 2, 3, and 4 as shown in Figure 7.

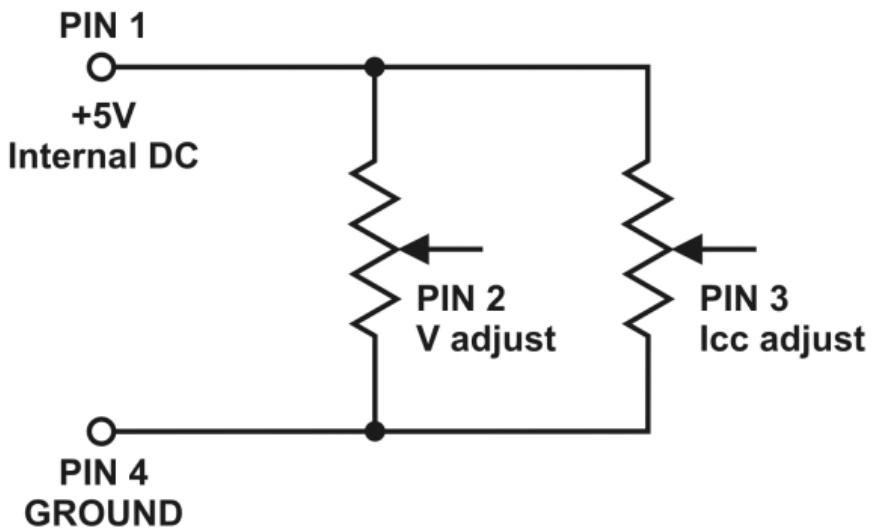

Figure 7 - Variable 5 k Ω Resistors Setup

PIN	FUNCTIONS	REMARKS
1	Internal DC +5 V	Resistor end
2	Voltage Adjust	Variable part of resistor
3	Current Adjust	Variable part of resistor
4	Ground	Resistor end
5	Output OFF	Short to Ground
6	N/A	
7	N/A	
8	N/A	

Table 5 – Remote Connector Plug Pin Assignment for Variable Resistors

3. Turn the remote control ON/OFF switch to ON position.
4. Switch on the power supply.
5. Check the output voltage range of the power supply by varying the 5 k Ω variable resistor for voltage adjustment.
6. Short circuit the main output with 8AWG gauge wire and check the display for CC setting by varying the 5 k Ω variable resistor for current adjustment.
7. Switch off the power supply.

4.4.2 Enable and Disable the Output

This remote output on/off control can be activated in any of the modes.

By default, Pin 5 is open and output is on.

Shorting Pin 5 to Pin 4 (ground) will turn the output off.

When output is off, the CV and CC LED will flash. The current output voltage and current setting will show on the panel meter.

You can also adjust the output by voltage and current control knob to your desired value when output is off.

5 Faults and Troubleshooting

5.1 OVP: Overvoltage Protection

This unit has a built-in tracking overvoltage protection feature. In the event of the output voltage becoming greater than the set value (see specified range from “Specifications”), protection will be triggered and the output power will be cut off. OVP warning will appear as shown below.



Figure 8 - Overvoltage Protection

To reset the warning, switch off the unit and remove all connected devices. Switch the unit back on again and it should resume normal operation. If the problem persists, please contact B&K Precision.

5.2 OTP: Overtemperature Protection

There is a thermo sensor inside the unit to monitor and prevent the unit from getting too hot. When OTP is triggered, there is no output and the following warning will appear on the LED display.



Figure 9 - Overtemperature Protection

When you get this warning, switch off the unit and remove all loading. Check your load and output settings and allow the unit to cool down for at least 30 minutes. Check if any of the ventilation is blocked and make sure there is enough clearance around the power supply. Listen carefully for the fan noise from the cooling fan when you turn on the unit again. If you cannot hear this routine self test fan noise upon power on, the fan has failed and the power supply should not be used. In this case, please contact B&K Precision.

5.3 OLP: Overload Protection

Normally the overload protection is sustained by the CC constant current mode. When the CC mode fails and goes undetected, it may cause serious damage to your test piece or load. The OLP is to minimize the extent of damage to your loads as power supplies will fail at some point in time. Switch off your power supply as soon as you see this warning as shown below.



Figure 10 - Overload Protection

To reset this warning, switch off the unit and remove all connected devices. Switch the unit back on again and double check with caution. If the problem persists, please contact B&K Precision.

5.4 Fuse Replacement

If the fuse blows, the CV or CC indicators will not light and the power supply will not operate. The fuse should not normally open unless a problem has developed in the unit. Try to determine and correct the cause of the blown fuse, then replace only with a fuse of the correct rating as listed below. The fuse is located on the rear panel (see Figure 2). Pull fuse compartment out with a flathead screwdriver and replace fuse in holder.

Line Voltage	Fuse	Type
100 – 120 VAC	12 A/250 V	20mm standard glass tube fast blow
220 – 240 VAC	8 A/250 V	20mm standard glass tube fast blow

Table 6 - Fuse Table

6 Specifications

Models	1900	1901	1902
Output			
Variable Output Voltage	1 – 16 V	1 – 32 V	1 – 60 V
Variable Output Current	0 – 60 A	0 – 30 A	0 – 15 A
Auxiliary Output Current	5 A		
Voltage Regulation			
Load (0-100% Load)	≤ 50 mV		
Line (90-132 VAC, 170-264 VAC Variation)	≤ 20 mV		
Current Regulation			
Load (10-90% Rated Voltage)	≤ 200 mA	≤ 150 mA	≤ 100 mA
Line (90-132 VAC, 170-264 VAC Variation)	≤ 50 mA		
Ripple & Noise			
Ripple & Noise Voltage (rms)	≤ 5 mV		
Ripple & Noise Voltage (peak-peak)	≤ 50 mV	≤ 50 mV	≤ 100 mV
Current Ripple & Noise (rms)	≤ 100 mA	≤ 50 mA (120 VAC) ≤ 40 mA (230 VAC)	≤ 15 mA
Meter Type & Accuracy			
Voltage Meter	3-Digit LED Display ± 0.2% + 3 counts		
Current Meter	3-Digit LED Display ± 0.2% + 3 counts		
Other			
Input Voltage	120 VAC 60 Hz, 230 VAC 50 Hz (request on order*)		
Full Load Input Current	9.4 A (120 VAC) 4.7 A (230 VAC)	9.0 A (120 VAC) 4.5 A (230 VAC)	9.3 A (120 VAC) 4.5 A (230 VAC)
Efficiency	84% (120 VAC) 85% (230 VAC)	87% (120 VAC) 86% (230 VAC)	87% (120 VAC) 88% (230 VAC)

Models	1900	1901	1902
Switching Frequency	65 – 85 kHz	75 – 95 kHz	65 – 85 kHz
Tracking Overvoltage Protections	O/P 1-5 V: set voltage +2 V O/P 5-16 V: set voltage +3 V	O/P 1-5 V: set voltage +2 V O/P 5-20 V: set voltage +3 V O/P 20-32 V: set voltage +4 V	O/P 1-5 V: set voltage +2 V O/P 5-20 V: set voltage +3 V O/P 20-60 V: set voltage +4 V
Transient Response Time (50-100% Load)	1.5 ms		
Power Factor Correction	> 0.95 at optimal load		
Cooling Method	Thermostatically controlled fan from zero to full speed		
Protections	Overload, Short Circuit by Constant Current, Overvoltage, Overtemperature		
Special Features	3 User-Defined Voltage and Current Presets, Analog Remote Control, Remote Sensing (model 1900 only)		
Operating Temperature	32 °F to 104 °F (0 °C to 40 °C) ≤ 80% R.H.		
Storage Temperature	5 °F to 158 °F (-15 °C to 70 °C) ≤ 85% R.H.		
Dimensions (WxHxD)	7.9" x 3.5" x 10.8" (200 x 90 x 275 mm)		
Weight	7 lbs (3.2 kg)		
Supplied Accessories	Power cord, instruction manual, remote control connector		

Note: All specifications apply to the unit after a temperature stabilization time of 15 minutes over an ambient temperature range of 23 °C ± 5 °C. Specifications are subject to change without notice.

*For 230 V version, request EXD model on order: 1900EXD, 1901EXD, or 1902EXD.

To ensure the most current version of this manual, please download the latest version here: <http://www.bkprecision.com/search/manual/1902>

For current up-to-date product information, please visit www.bkprecision.com

7 Certification

CE Compliant

CE Declaration of Conformity

The power supply meets the requirements of 2006/95/EC Low Voltage Directive and 2004/108/EC Electromagnetic Compatibility Directive.

Low Voltage Directive

- EN 60950
- EN 61010
 - o Safety requirements for electrical equipment for measurement, control, and laboratory use.

EMC Directive

- EN 55011
- EN 55022
 - o Electrical equipment for measurement, control, and laboratory use.

8 Service Information

Warranty Service: Please go to the support and service section on our website at www.bkprecision.com to obtain an RMA #. Return the product in the original packaging with proof of purchase to the address below. Clearly state on the RMA the performance problem and return any leads, probes, connectors, and accessories that you are using with the device.

Non-Warranty Service: Please go to the support and service section on our website at www.bkprecision.com to obtain an RMA #. Return the product in the original packaging to the address below. Clearly state on the RMA the performance problem and return any leads, probes, connectors, and accessories that you are using with the device. Customers not on an open account must include payment in the form of a money order or credit card. For the most current repair charges, please refer to the service and support section on our website.

Return all merchandise to B&K Precision Corp. with pre-paid shipping. The flat-rate repair charge for Non-Warranty Service does not include return shipping. Return shipping to locations in North America is included for Warranty Service. For overnight shipments and non-North American shipping fees, please contact B&K Precision Corp.

B&K Precision Corp.
22820 Savi Ranch Parkway
Yorba Linda, CA 92887
www.bkprecision.com
714-921-9095

Include with the returned instrument your complete return shipping address, contact name, phone number, and description of problem.

9 Limited Two-Year Warranty

B&K Precision Corp. warrants to the original purchaser that its products and the component parts thereof will be free from defects in workmanship and materials, for a period of **two years** from date of purchase.

B&K Precision Corp. will, without charge, repair or replace, at its option, defective product or component parts. Returned product must be accompanied by proof of the purchase date in the form of a sales receipt.

To obtain warranty coverage in the U.S.A., this product must be registered by completing a warranty registration form on our website www.bkprecision.com within fifteen (15) days of purchase.

Exclusions: This warranty does not apply in the event of misuse or abuse of the product or as a result of unauthorized alterations or repairs. The warranty is void if the serial number is altered, defaced, or removed.

B&K Precision Corp. shall not be liable for any consequential damages, including without limitation, damages resulting from loss of use. Some states do not allow limitations of incidental or consequential damages. So the above limitation or exclusion may not apply to you.

This warranty gives you specific rights and you may have other rights, which vary from state-to-state.

B&K Precision Corp.
22820 Savi Ranch Parkway
Yorba Linda, CA 92887
www.bkprecision.com
714-921-9095

(Page intentionally left blank)

BK⁺ PRECISION[®]

22820 Savi Ranch Parkway

Yorba Linda, CA 92887

www.bkprecision.com

© 2011 B&K Precision Corp.