

# ***Makita***

アメリカ

## PUMP

MODEL : **EW200TR**  
**EW300TR**  
**EW400TR**

## INSTRUCTION MANUAL

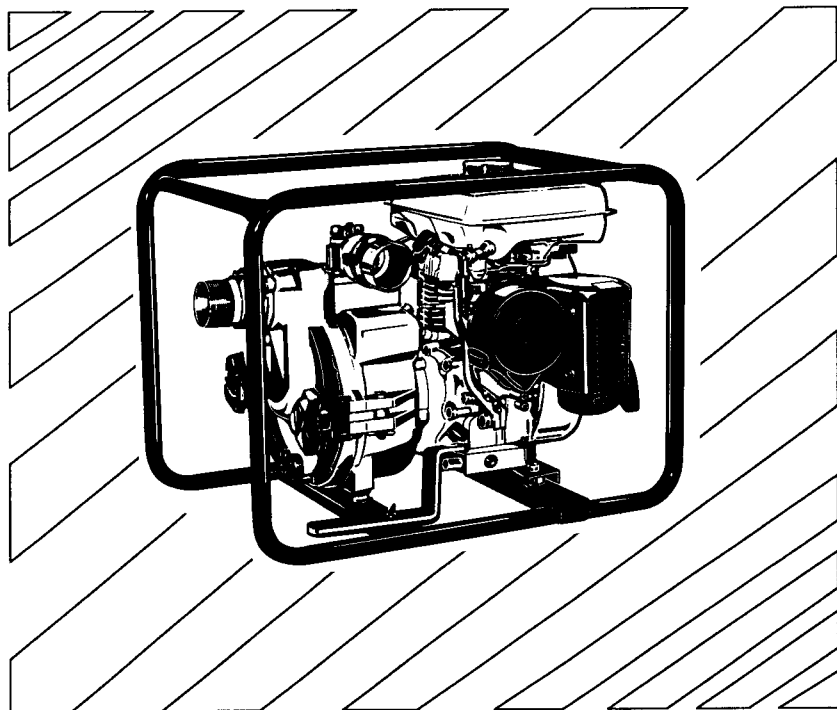

ISSUE EMD-PU0835

9ZZ9020021

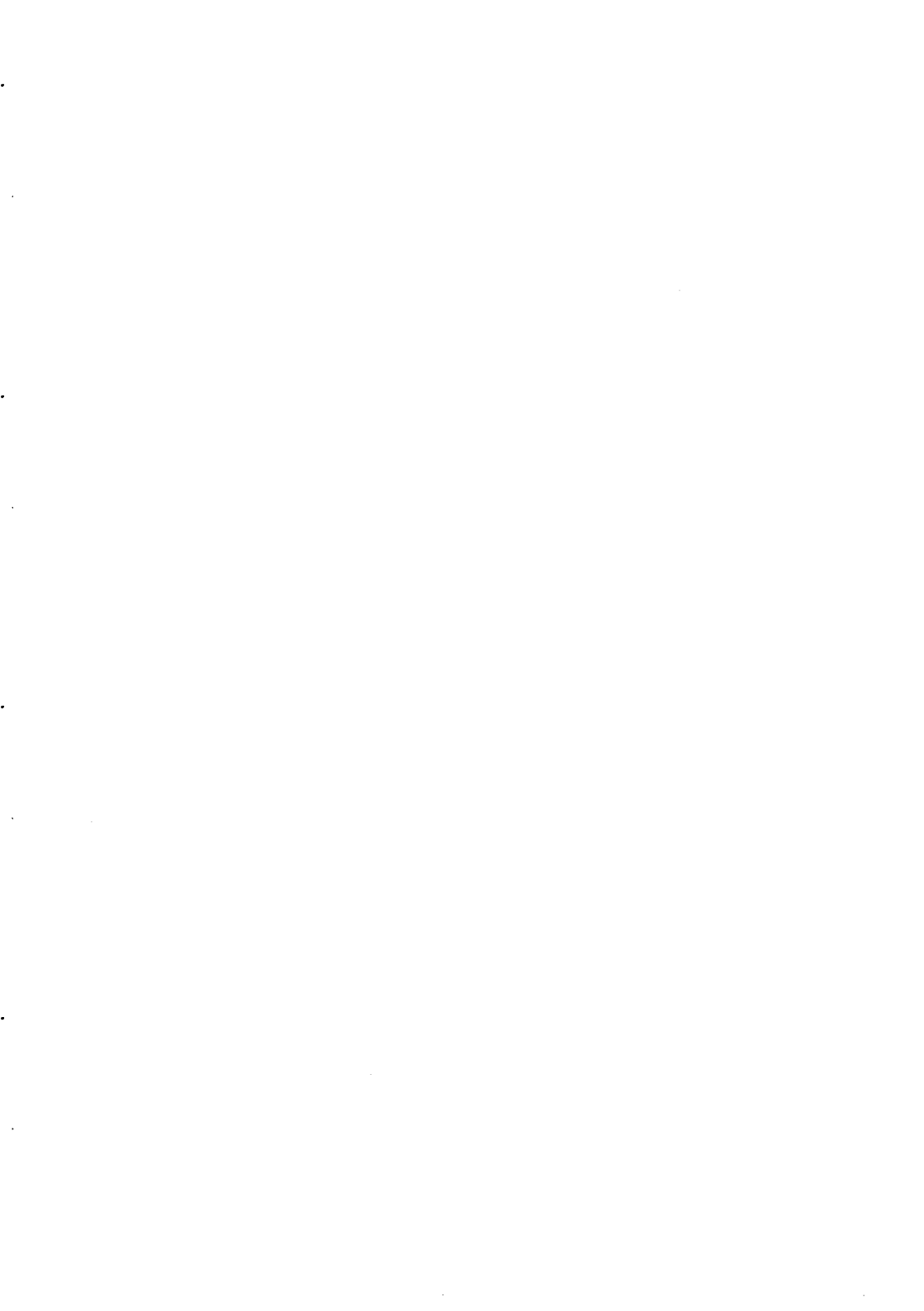

# FOREWORD

Thank you for purchasing a Makita trash pump.  
This manual covers operation and maintenance of trash pumps.  
All information in this publication is based on the latest product information available at the time of approval for printing.  
Please read this manual carefully before operating.

# CONTENTS

	<b>Page</b>
1. PUMP SAFETY .....	1
2. COMPONENTS .....	2
3. PREPARATIONS FOR STARTING .....	3
4. STARTING THE ENGINE .....	5
5. OPERATION .....	7
6. STOPPING THE ENGINE .....	8
7. MAINTENANCE SCHEDULE .....	9
8. "HOW-TO" MAINTENANCE .....	10
9. TROUBLESHOOTING .....	12
10. PREPARATIONS FOR STORAGE .....	14
11. OIL SENSOR INSTRUCTIONS .....	15

# 1. PUMP SAFETY

---

Please make sure you review each precaution carefully.

## **SURROUNDINGS**

- Operate the pump on a stable, level surface free of small rocks, loose gravel, etc.
- Keep pump at least 3 feet (1 meter) away from buildings.
- Keep pump away from flammables and other hazardous materials (trash, rags, lubricants, explosives).

## **FIRE PREVENTION**

- Be sure to stop the engine prior to refueling.
- Do not overfill fuel tank.
- If spillage does occur, wipe away spilt fuel thoroughly and wait until fuel has dried before starting engine.
- Do not operate while smoking or near an open flame.

## **EXHAUST PRECAUTION**

- Never inhale exhaust gasses ; they contain carbon monoxide, a colorless, odorless, extremely dangerous gas which can cause unconsciousness or death.
- Never operate the pump indoors or in an enclosed area such as a cave or a tunnel.
- Exercise extreme care when operating near people and domestic animals.

## **OTHER IMPORTANT POINTS**

- Keep away from rotating parts and hot parts while the pump is running.
- Never permit anyone to operate the pump without proper instructions.
- Know how to stop the pump quickly and understand operation of all the controls.
- Tighten the fuel tank cap securely and close the fuel cock before transit.
- Check the engine oil and refill if necessary.
- Carefully check fuel pipes and joints for looseness and fuel leakage.

# 2. COMPONENTS

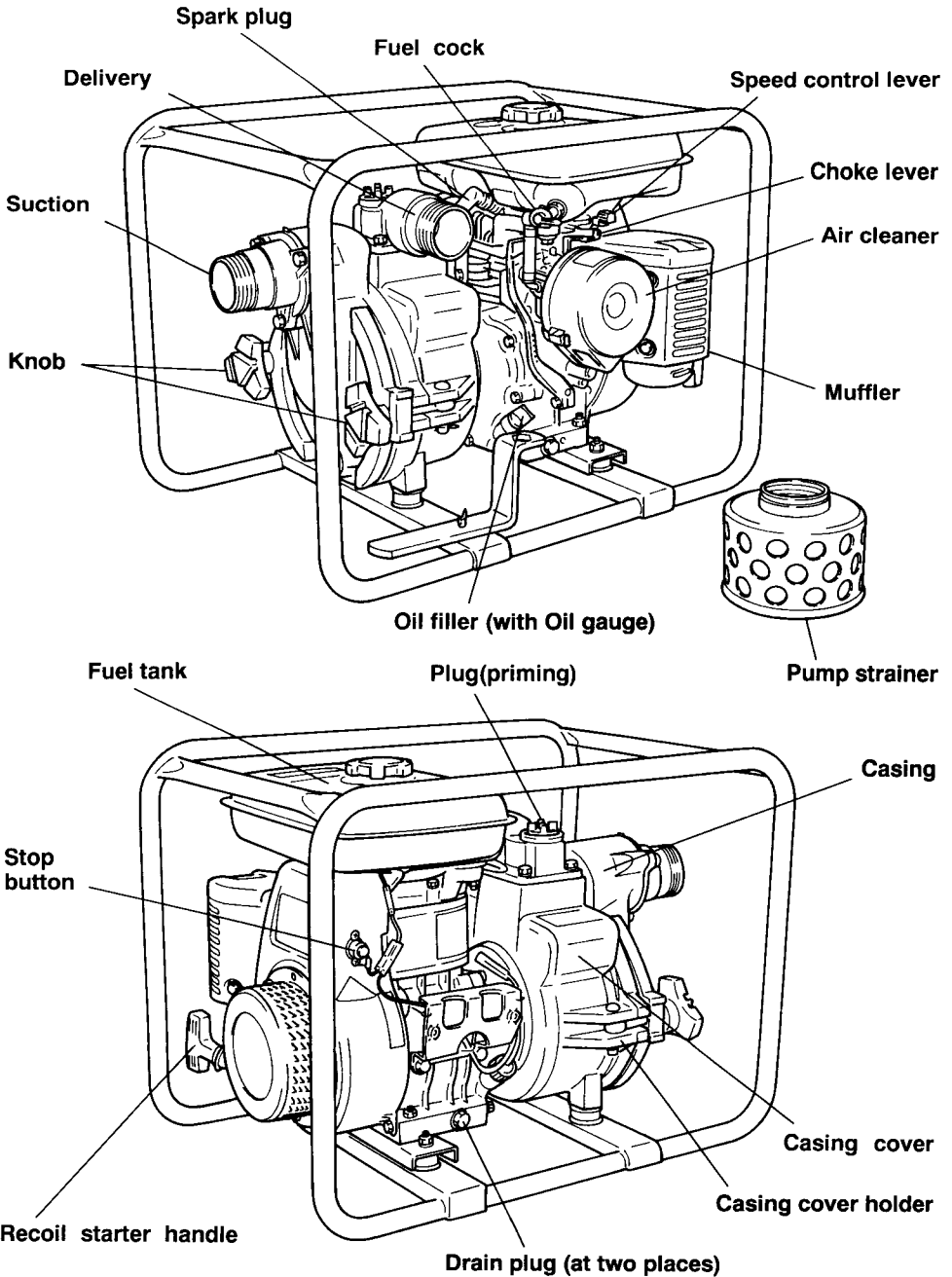

# 3. PREPARATIONS FOR STARTING

## 1. Connect the suction hose.

Use a reinforced-wall or wire braided hose to prevent suction collapse. Since the pump's self-priming time is directly proportional to hose length, a short hose is recommended.

**[CAUTION]**

- Always use a strainer with the suction hose. Gravel or debris sucked into the pump will cause serious damage to the impeller and the pump casing.

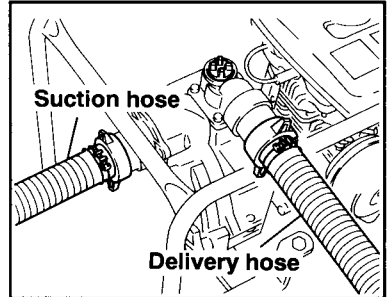

## 2. Connect the discharge hose.

When using a fabric hose, always use a hose band to prevent the hose from disconnecting under high pressure.

## 3. Check the engine oil level.

Engine oil is a major factor affecting engine performance and service life.

Nondetergent or vegetable oils are not recommended.

Use oil classified "SC" or higher grade.

If the oil level is below the fill level line on the dipstick, refill with the proper oil (see table) to edge of the oil fuller neck.

Be sure to check the oil level on a level surface with the engine stopped.

Single grade	5W						
	10W						
	20W						
	# 20						
	# 30						
Multigrade	10W-30						
	10W-40						
Ambient temperature	-20	-10	0	10	20	30	40°C
	-4	14	32	50	68	86	104°F

---

#### 4. Check the fuel level.

If level is low, fill to the shoulder of the fuel filter. Use fresh, clean automotive gasoline.

#### 5. Check the priming water.

It is recommended that the water chamber of pump casing should be primed with full of water before operating.

#### [CAUTION]

- Never attempt to operate the pump without priming water or the pump will overheat. Extended dry operation will destroy the mechanical seal. If the unit has been operated dry, stop the engine immediately and allow the pump to cool before adding priming water.

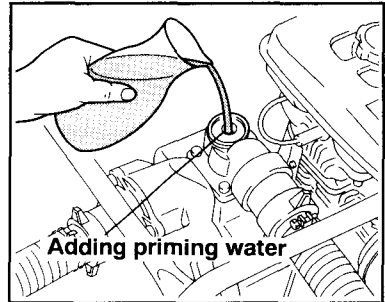
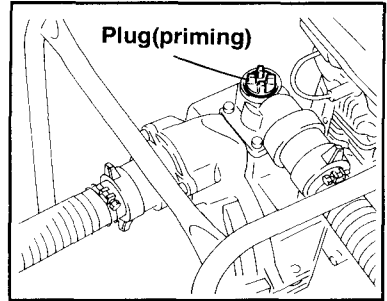

# 4. STARTING THE ENGINE

1. Open the fuel cock.

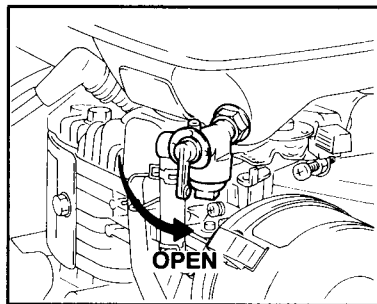

2. Set the speed control lever to "START."

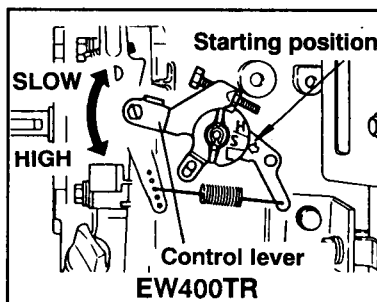
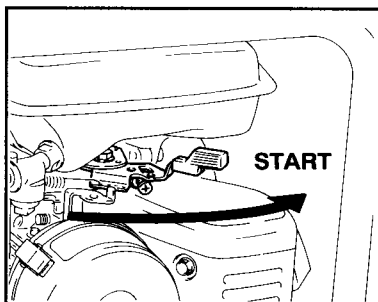

3. Close the choke.

- If the engine is warm or the ambient temperature is high, close the choke half-way, or keep it open fully.
- If the engine is cold, or the ambient temperature is low, close the choke.

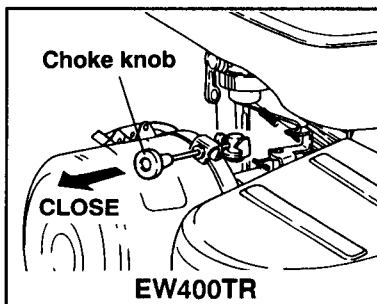
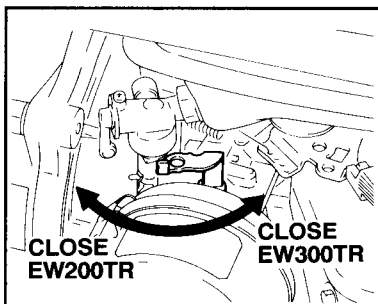



- 
4. Pull the starter handle slowly until resistance is felt. This is the "compression" point. Return the handle to its original position and pull swiftly.
- Do not pull out the rope all the way.
  - After starting the engine, allow the starter handle return to its original position while still holding the handle.

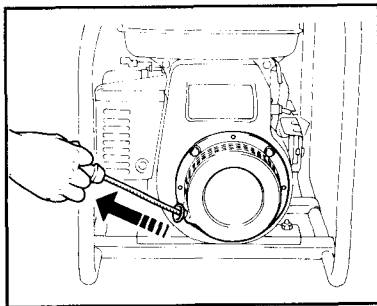

# 5. OPERATION

1. After starting the engine, gradually open choke by turning the choke lever and finally keep it open fully.
  - Do not fully open the choke immediately when the engine is cold or the ambient temperature is low, because the engine may stop.

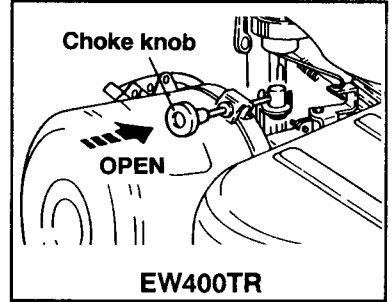
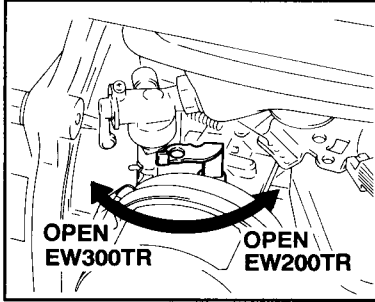

2. After the engine starts, set the speed control lever at the low speed position (L) and warm it up without a load for a few minutes.

Gradually move the speed control lever toward the high speed position (H) and set it at the required engine speed.

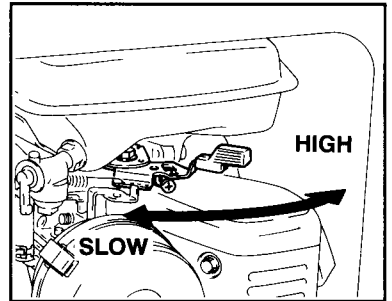

## NOTE :

Whenever high speed operation is not required, slow the engine down (idle), by moving the speed control lever to save fuel and extend engine life.

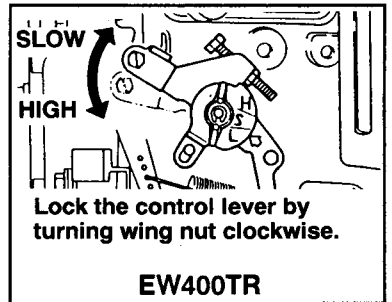

# 6. STOPPING THE ENGINE

---

1. Set the speed control lever to the low speed position and allow the engine to run at low speed for 2 or 3 minutes before stopping.

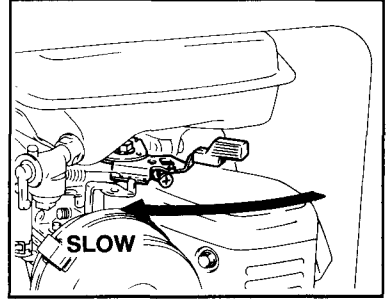

2. Keep depressing the STOP BUTTON until the engine stops.  
Do not stop the engine suddenly when it is running at high speed.
3. Close the fuel cock.

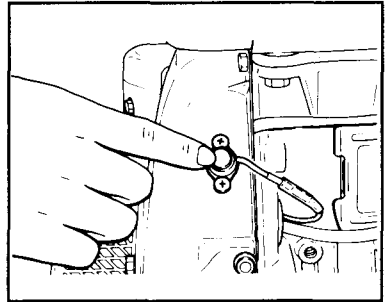

4. Pull the starter handle slowly and return the handle to its original position when resistance is felt.

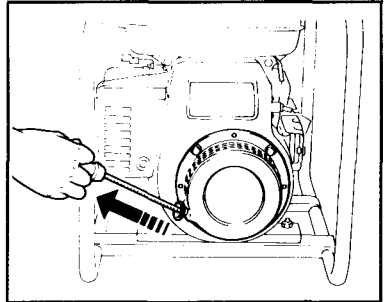

## NOTE :

The above operation is necessary to prevent outside moist air from intruding into the combustion chamber.

## STOPPING ENGINE WITH THE FUEL COCK

Close the fuel cock and wait for a while until the engine stops. Avoid letting fuel remain in the carburetor long period, or the passages of the carburetor may become clogged with impurities, and malfunctions may result.

# 7. MAINTENANCE SCHEDULE

## DAILY INSPECTION

Before running the pump, check the following service items:

- Enough fuel.
- Excessive vibration, noise.
- Clean air cleaner element.
- Safe surroundings.
- Enough clean engine oil.
- Leakage of gasoline and engine oil.
- Loose or broken bolts and nuts.
- Check the priming water.

## PERIODIC INSPECTION

Periodic maintenance is vital to the safe and efficient operation of your pump. Check the table below for periodic maintenance intervals.

The following chart is based on the normal pump operation schedule.

	8 hours (daily)	50 hours (weekly)	200 hours (monthly)	500 hours	1000 hours
Clean engine and check bolts and nuts.	○ (daily)				
Check and refill engine oil.	○ (Refill daily up to the upper limit.)				
Change engine oil.	(Initial 20 hours)	○			
Clean spark plug.		○			
Clean air cleaner.		○			
Remove the pump casing and clean.			○		
Clean fuel strainer.			○		
Clean and adjust spark plug gap.			○		
Clean and adjust carburetor.				○	
Clean cylinder head.				○	
Adjust valve clearance.				○	
Overhaul engine.				○	○

### [CAUTION]

- Replace rubber pipes for fuel passage every two years. If fuel leakage is found, replace the pipe immediately.

# 8. "HOW TO" MAINTENANCE

## INSPECTING THE SPARK PLUG

- Clean off carbon deposits on the plug electrode using a plug cleaner or wire brush.
- Check electrode gap. Adjust it to between 0.02 and 0.03 inches. (0.6 and 0.7mm)

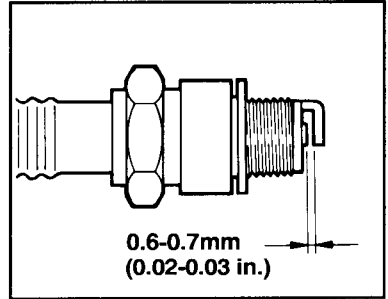

## ENGINE OIL CHANGE

- Initial oil change.....20 hours of operation
- Thereafter...Every 50 hours of operation

### [CAUTION]

Make sure the fuel cap is tightly secured to avoid spillage.

- When changing oil, stop the engine and loosen the drain plug.
- Tighten the drain plug before refilling.
- Refer to the recommended oil table on page 3.
- Always use the proper grade and clean oil. If the engine oil is contaminated, there is not enough or it is of poor quality, engine life will be shortened.

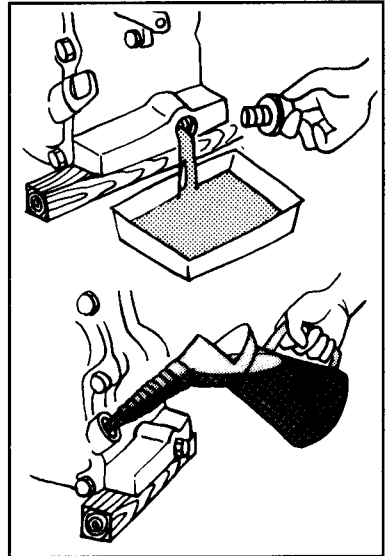

## CLEANING FUEL STRAINER

- Check for water or contaminants in the fuel strainer.
- To remove contaminants, close the fuel cock and remove the strainer cup.
- After removing contaminants and water, wash the strainer cup with kerosene. Reinstall it securely to prevent leakage.

---

## SERVICING THE AIR CLEANER

Maintaining an air cleaner in proper condition is very important. Dirt induced through improperly installed, improperly serviced or inadequate elements, wears out engines. Keep the element always clean.

(a) Unlock the cover and remove the cleaner element.

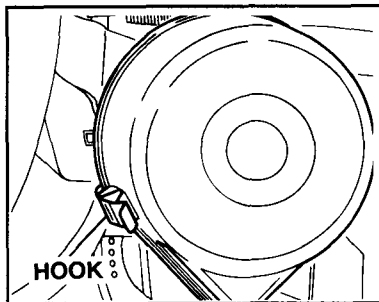

(b) Inner element: Wash the element with kerosene, then soak it in mixed oil (Kerosene (3): Engine oil (1)).  
Drain the mixed oil.

(c) Outer element: Wash the element with kerosene, then dip it into the mixed oil (Kerosene (3): Engine oil (1)).  
Squeeze out the mixed oil. (Do not twist.)

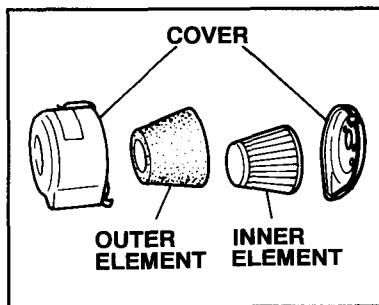

## FUEL PIPE REPLACEMENT

Replace the fuel pipe every 2 years.

If the fuel pipe is found leaking, replace it immediately.

## CHECKING BOLTS, NUTS AND SCREWS

Retighten loose bolts and nuts.

Check for fuel and oil leaks.

Replace damaged parts with new ones.

## CLEANING PUMP INSIDE

Turn the knob counterclockwise and open the casing cover holder.

Pull the casing toward you, and then remove the casing and the inner casing.

Clean the inside of pump casing and casing cover with clean water.

# 9. TROUBLESHOOTING

---

**Pump does not run.**

Engine does not start.  
(See page 13.)

Sticking of impeller (Disassemble and clean.)

**Pumping volume is small.**

Sucking air at suction side  
(Check piping at suction side.)

Drop in engine output  
(Consult your nearest dealer.)

Breakage of mechanical seal  
(Consult your nearest dealer.)

High suction lift (Lower.)

Suction hose is too long or thin.  
(Use a thick hose in minimum length.)

Leak of water from water passage  
(Stop leaking.)

Clogging of foreign substance in impeller  
(Disassemble and clean.)

Wear of impeller

Strainer is clogged (Clean.)

Engine speed is too low  
(Consult your nearest dealer.)

**Pump does not self-prime.**

Suction of air at suction side.  
(Check piping at suction side.)

Insufficient priming water inside pump casing  
(Prime fully.)

Imperfect tightening of drain plug  
(Tighten the plugs completely.)

Engine speed is too low.  
(Consult your nearest dealer.)

Sucking air from mechanical seal  
(Consult your nearest dealer.)

## WHEN ENGINE DOES NOT START:

- Perform the following checks before you take the pump to your Makita dealer.
- If you still have trouble after completing the checks, take the pump to your nearest Makita dealer.

### WARNING

- Before testing, carefully wipe off spilled fuel.  
Put the plug as far away from the spark plug hole as possible.  
Ground the side of the electrode to any engine ground.

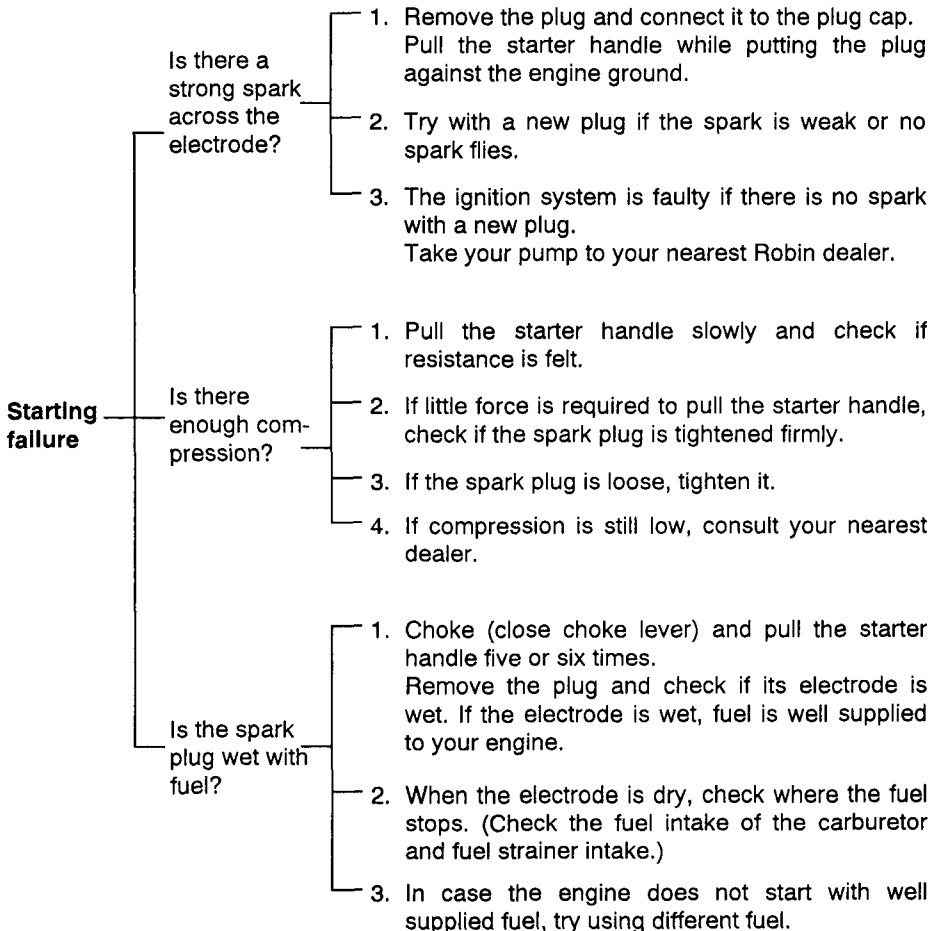



# 10. PREPARATIONS FOR STORAGE

- Drain all water from the drain plug.

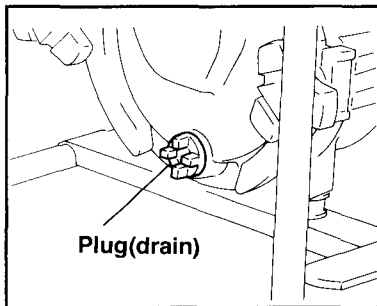

## [CAUTION]

- When retightening drain plug, be sure to clean the drain plug and the thread of casing. Otherwise, the thread may be damaged.

- Remove the strainer cup, and open the strainer cock to discharge the fuel from the fuel tank.  
Remove the carburetor float chamber bolt from the bottom and discharge fuel from the carburetor. (**NO SMOKING !**)
- Change the used engine oil with fresh oil.  
Remove the spark plug, pour about 5 cc of engine oil into the cylinder, slowly pull the starter knob of the recoil starter 2 or 3 times, and tighten the spark plug.
- Slowly pull the recoil starter knob until resistance is felt and leave it in that position.
- Store the pump in a dry place free from sand or dust.  
Always keep the pump covered.

# 11. OIL SENSOR INSTRUCTIONS

## OIL SENSOR (OPTION)

- (a) The oil sensor detects the fall in oil level in the crankcase and automatically stops the engine when the oil level falls down below the predetermined level.
- (b) When engine has stopped automatically, check the oil level. Refill engine oil to the upper level and restart the engine.
- (c) If the engine does not start by usual starting procedures, check the oil level.

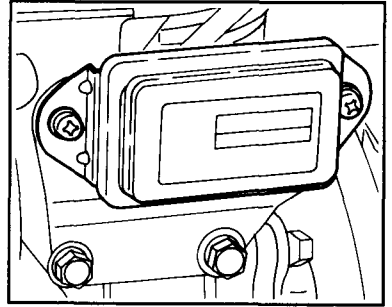

### [CAUTION]

- Do not remove OIL SENSOR PROBE when refilling with oil. Remove oil filler cap on the opposite side of carburetor.



マキタ

## MAKITA LIMITED ONE YEAR WARRANTY

### Warranty Policy

Every Makita tool is thoroughly inspected and tested before leaving the factory. It is warranted to be free of defects from workmanship and materials for the period of ONE YEAR from the date of original purchase. Should any trouble develop during this one-year period, return the COMPLETE tool, freight prepaid, to one of Makita's Factory or Authorized Service Centers. If inspection shows the trouble is caused by defective workmanship or material, Makita will repair (or at our option, replace) without charge.

This Warranty does not apply where:

- repairs have been made or attempted by others;
- there is evidence of normal wear and tear;
- The tool has been abused, misused or improperly maintained;
- alterations have been made to the tool.

Defects are due to the use of parts, accessories or attachments which are not Makita genuine products, specifically recommended for use with this tool.

Damage may be caused in transit. (This must be the responsibility of the carrier.) Claims arise from regulations such as for noise levels, exhaust gas emissions, etc. This product has been operated for racing purposes or other competitive activities. This product has been employed for powering equipment that is operated on, in or near water or explosive atmospheres.

The following parts are expendable (not durable), so warranty does not apply:

Expendable parts including, but not limited to:

Spark plugs, packings, gaskets, rubber materials, washers, nuts, V-belt, engine oil, grease, paper elements, brushes, mechanical seal, pump impeller and volute casing.

IN NO EVENT SHALL MAKITA BE LIABLE FOR ANY INDIRECT, INCIDENTAL OR CONSEQUENTIAL DAMAGES FROM THE SALE OR USE OF THE PRODUCT. THIS DISCLAIMER APPLIES BOTH DURING AND AFTER THE TERM OF THIS WARRANTY.

MAKITA DISCLAIMS LIABILITY FOR ANY IMPLIED WARRANTIES, INCLUDING IMPLIED WARRANTIES OF "MERCHANTABILITY" AND "FITNESS FOR A SPECIFIC PURPOSE," AFTER THE ONE-YEAR TERM OF THIS WARRANTY.

This Warranty gives you specific legal rights, and you may also have other rights which vary from state to state. Some states do not allow the exclusion of limitation of incidental or consequential damages, so the above limitation or exclusion may not apply to you. Some states do not allow limitation on how long an implied warranty lasts, so the above limitation may not apply to you.

**Makita Corporation**  
3-18-8, Sumiyoshi-cho  
Anjo, Aichi 446 Japan