

Miele

Operating Instructions

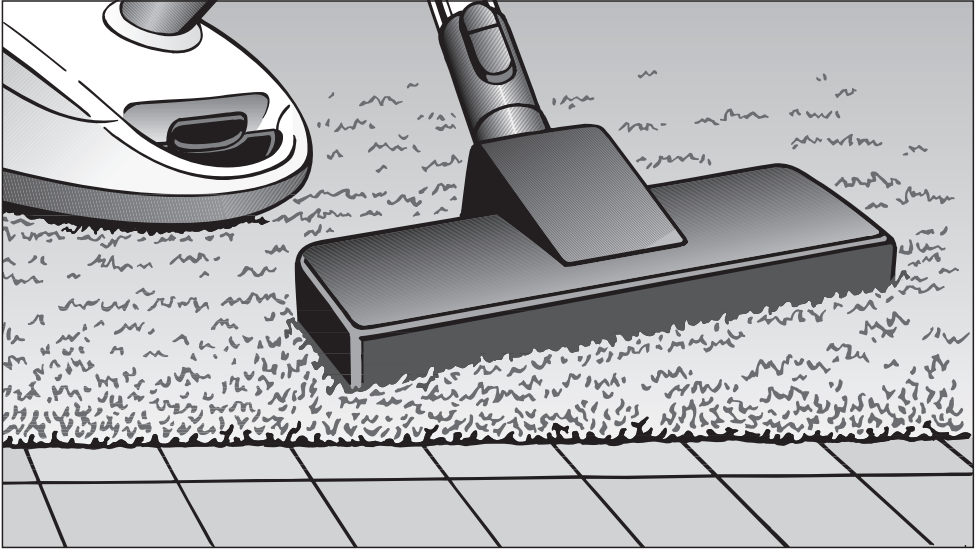

Vacuum Cleaner S 6000

To prevent accidents
and machine damage,
read these instructions
before
installation and use.

HS14

en - US, CA

M.-Nr. 07 968 171

IMPORTANT SAFETY INSTRUCTIONS	4
Guide to the vacuum cleaner	8
Before using the vacuum cleaner	10
Using the included accessories	13
Operation	14
Power cord	14
Turning the vacuum on and off	15
Adjusting the suction	16
Opening the air inlet valve	17
Park-System	17
Maintenance and care	18
Purchasing new dustbags and filters	18
Which dustbags and filters are the right ones?	18
When to change the dustbag	19
Replacing the dustbag	20
Replacing the exhaust filter	21
Replacing the "Air Clean" filter	21
Replacing the "Active Air Clean" filter and the "Active HEPA" filter	22
Exchanging exhaust filters	23
When to change the dust compartment filter (motor protection)	24
Replacing the dust compartment filter (motor protection)	24
When to change the thread catcher pads of the standard floor brush	25
Replacing the thread catchers	25
Cleaning and care	26
Frequently asked questions	27
Optional accessories	28
Technical Service	30
Caring for the environment	31

IMPORTANT SAFETY INSTRUCTIONS

When using an electrical appliance, basic precautions should always be followed, including the following:

READ ALL INSTRUCTIONS BEFORE USING THIS APPLIANCE

WARNING-

To reduce the risk of fire, electric shock or injury:

Before using

▶ Check the voltage rating of the vacuum cleaner before connecting the power cord to an electrical outlet. Your power source should correspond with the voltage rating plate located on the underside of the vacuum. Use only household AC outlets. Never use DC power sources. If you are not sure of your home's voltage supply, consult a qualified electrician. Connecting the vacuum cleaner to a higher voltage than indicated in these instructions may result in damage to the vacuum cleaner or injury.

▶ To reduce the risk of electric shock, this appliance has a polarized plug (one blade is wider than the other.) This plug will fit in a polarized outlet only one way. If the plug does not fit fully in the outlet, reverse the plug. If it still does not fit, contact a qualified electrician to install the proper outlet. Do not alter the plug in any way.

▶ A damaged vacuum cleaner can be dangerous. Check the packaging, vacuum cleaner and accessories for any signs of damage. Do not use a damaged appliance.

▶ Do not use with a damaged cord or plug. If the appliance is not working as it should, has been dropped, damaged, left outdoors or submerged in water, bring it to a service center.

▶ The electrical outlet must be fitted with a 15 A fuse.

IMPORTANT SAFETY INSTRUCTIONS

Use

- ▶ Do not use on people or animals.
- ▶ Do not use outdoors or on wet surfaces. Only **dry** surfaces should be vacuumed.
- ▶ Use only as described in this manual with Miele recommended accessories.
- ▶ This appliance is intended strictly for household use only.
- ▶ Do not allow the vacuum cleaner to be used as a toy. Close attention is necessary when used near children.
- ▶ Never use the vacuum cleaner without the dustbag or filters in place. Otherwise it could be damaged.
- ▶ If a dustbag is not inserted, the dust compartment lid will not close. Do not force it shut.
- ▶ Do not leave the vacuum plugged in. Unplug it from the outlet when not in use and before servicing.
- ▶ On the underside of the vacuum handpiece is a metal insert designed to absorb static electricity. Please make certain that your hand remains around this metal insert when vacuuming.
- ▶ Persons which lack physical, sensory or mental abilities or experience with the machine should not use it without supervision or instruction by a responsible person.
- ▶ Unwind the cord completely to aid the vacuum in dissipating heat.
- ▶ This vacuum should not be used to entrap or retain any hazardous materials.
- ▶ Do not use the vacuum cleaner to pick up liquids or damp dirt. This could impair the electrical safety of the vacuum cleaner. Wait for freshly shampooed carpets to dry.
- ▶ Do not vacuum anything that is burning or smoking, such as cigarettes, matches, or hot ashes. The vacuum cleaner could catch fire.
- ▶ Do not vacuum toner dust. Toner, such as that used in printers and photocopiers can conduct electricity.
- ▶ Do not use to pick up flammable or combustible liquids, such as gasoline, or use in areas where they may be present. The vacuum cleaner could explode.
- ▶ Do not vacuum items which are heavy, hard or have sharp edges. They could cause a blockage and damage the appliance.
- ▶ Do not pull or carry by the cord, use the cord as a handle, close a door on the cord, or pull the cord around sharp edges or corners. Do not run the appliance over the cord. Keep the cord away from heated surfaces.

IMPORTANT SAFETY INSTRUCTIONS

- ▶ Do not unplug by pulling on the cord. To unplug, grasp the plug, not the cord.
- ▶ Do not handle the plug or vacuum with wet hands.
- ▶ Keep the power cord, hair, loose clothing, fingers and all parts of the body away from openings and moving parts.
- ▶ Do not place anything into the openings of the vacuum cleaner. Do not use if any openings are blocked; keep them free of dust, lint, hair, or anything that may reduce air flow.
- ▶ This appliance is equipped with a power cord reel. Hold the plug when rewinding onto cord reel. Do not allow the plug to whip when rewinding.
- ▶ Turn off all controls before unplugging.
- ▶ Use extra care when cleaning on stairs.
- ▶ Floor attachments, accessories and wands must not be used at head level to avoid injury to eyes and ears.
- ▶ Monitor the dustbag change indicator and inspect all filters regularly. For best performance, the dustbag and filters should be replaced when necessary. A full bag or blocked filter will reduce the vacuum cleaner's suction power. A temperature limiter automatically switches the vacuum cleaner off if it gets too hot, see "Frequently asked questions".

Using accessories

- ▶ The hose and the telescopic wand contain electrical wires. Do not use the vacuum cleaner if these parts are damaged, cut or punctured. Avoid picking up sharp objects. Danger of electric shock!
- ▶ Unplug the vacuum when changing accessories, especially the Turbobrush, and Powerbrush.
- ▶ To avoid the risk of injury when vacuuming with a Miele Power or Turbobrush do not touch the rotating roller brush. Danger of injury.
- ▶ The socket on the vacuum cleaner (depending on model) must only be used for the Miele Powerbrush specified for use with this appliance.
- ▶ Danger of injury. The Miele Powerbrush is a motor driven accessory for use only with Miele vacuum cleaners. The vacuum cleaner must not be used with another manufacturer's powerbrush.
- ▶ Do not use the vacuum without an accessory attached. The rim could be damaged and injuries could result from sharp edges.
- ▶ Miele dust bags are disposable and intended to be used only once. Do not attempt to reuse. An over stuffed dustbag will reduce the efficiency of the vacuum cleaner.
- ▶ Only use genuine Miele dustbags with the Miele quality signet and original Miele filters and accessories. Only then will the manufacturer guarantee its safety.

IMPORTANT SAFETY INSTRUCTIONS

Cleaning, maintenance and repairs

- ▶ Turn the vacuum cleaner off after each use and before every cleaning / maintenance. Pull the plug from the outlet.
- ▶ Never submerge the vacuum cleaner in water. Clean only with a dry cloth or slightly damp cloth when disconnected from the mains supply. If moisture gets into the appliance there is a risk of electric shock.
- ▶ Monitor the dustbag change indicator and inspect all filters regularly. For best performance, the dustbag and filters should be replaced when necessary. A full bag or blocked filter will reduce the vacuum cleaner's suction power. A temperature limiter automatically switches the vacuum cleaner off if it gets too hot, see "Frequently asked questions".
- ▶ Repairs must only be performed by an authorized service agent in accordance with national and local safety regulations. Unauthorized repairs could cause injury or machine damage. The manufacturer cannot be held responsible for unauthorized work.
- ▶ If the power cord is damaged it should be replaced along with a new cable reel by Miele Technical Service.

Disposal

- ▶ Before discarding an old vacuum cleaner, please cut off the power cord and render the plug useless. Ensure the appliance presents no danger to children while being stored for disposal.

SAVE THESE INSTRUCTIONS

Guide to the vacuum cleaner

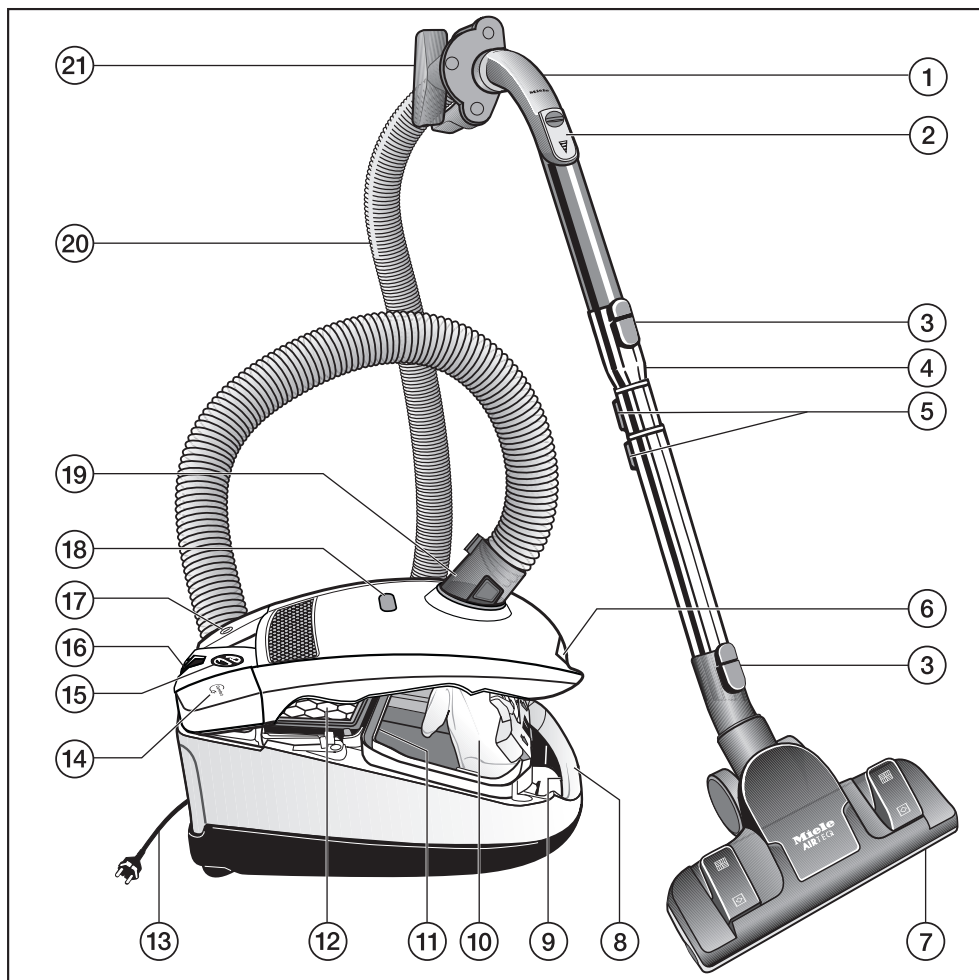

Guide to the vacuum cleaner

- ① Hand piece XXL *
- ② Air inlet valve *
- ③ Lock release button
- ④ Three piece telescopic wand *
- ⑤ Telescopic wand release button *
- ⑥ Dust compartment lid release
- ⑦ Floor brush *
- ⑧ Carrying handle
- ⑨ Socket for Powerbrush
- ⑩ Dustbag
- ⑪ Dust compartment filter (pre-motor filter)
- ⑫ Exhaust filter *
- ⑬ Power cord
- ⑭ Cord rewind switch
- ⑮ Suction power selector
- ⑯ Park-System
- ⑰ On/Off ① foot switch
- ⑱ Airflow indicator
- ⑲ Hose connector *
- ⑳ Suction hose *
- ㉑ Accessory clip

The illustration shows the maximum number of features available in this series of Miele vacuum cleaners.

Those features marked * depend on the model and may vary or not be available on your model.

Some models are supplied with a Miele Powerbrush or Turbobrush as standard (not illustrated). Separate operating and maintenance instructions are supplied with these brushes.

Before using the vacuum cleaner

Attaching the suction hose

- Insert the elbow into the suction socket until it clicks. Use the inlet guides to direct insertion.

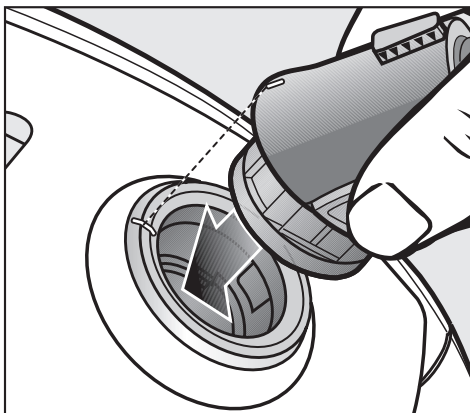

Removing the suction hose

- Press the release buttons at the sides of the elbow and lift the hose from the socket.

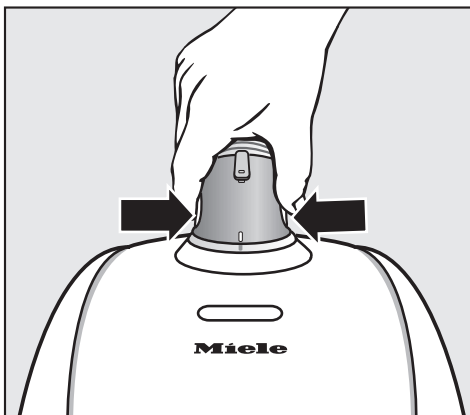

Before using the vacuum cleaner

Connecting the handpiece and telescopic wand

- Insert the handpiece into the telescopic wand. Use inlet guides to direct insertion.
- To release the handpiece from the telescopic wand press the locking button (see arrow) and pull the handpiece away from the telescopic wand with a slight twist.

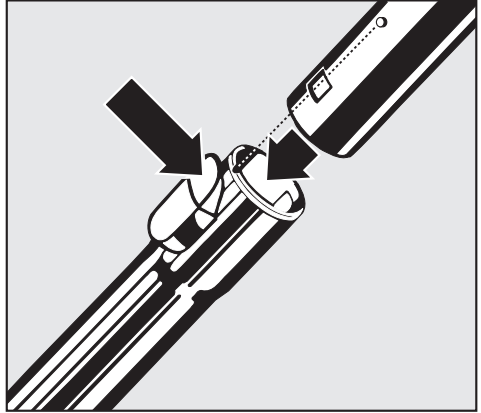

Adjusting the telescopic wand

This telescopic wand consists of two sections which are height-adjustable.

- Press the adjustment button to release the tubes and adjust to the desired height.

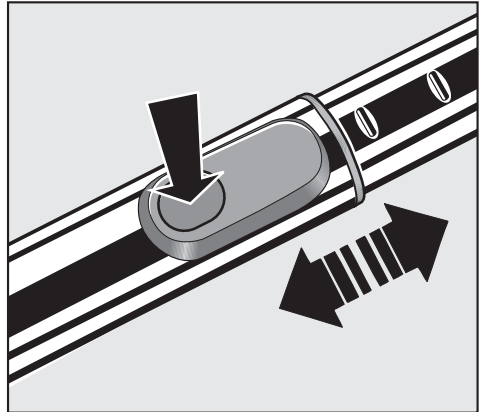

Before using the vacuum cleaner





Attaching the standard floor brush

(depending on model)



- Insert the wand into the floor brush and twist until it locks with a click.
- To release the floor brush from the telescopic wand, press the locking button (see arrow) and pull the wand out of the floor brush.

Observe the cleaning instructions of the floor manufacturer.



Depending on the floor brush the following symbols are shown:

-  and 
-  and 

To clean carpets and area rugs:

- Press the foot switch marked  or .

To clean hard flooring:

- Press the foot switch marked  or .

Floors with very deep joints and cracks should be vacuumed using the floor brush with the bristles out.

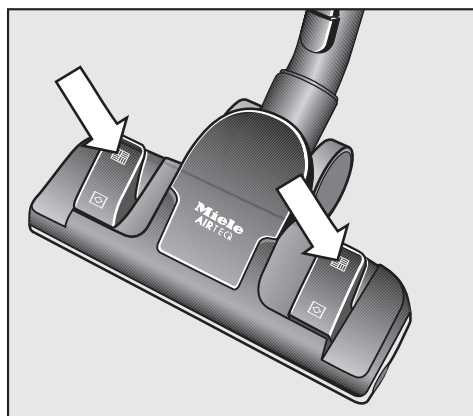
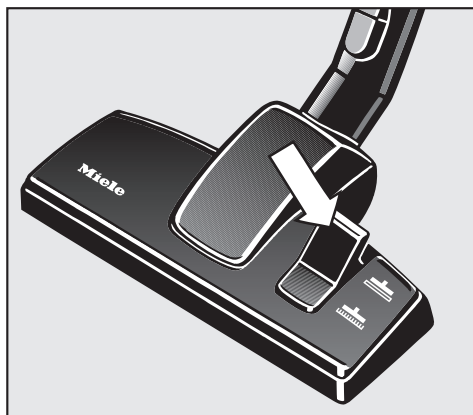
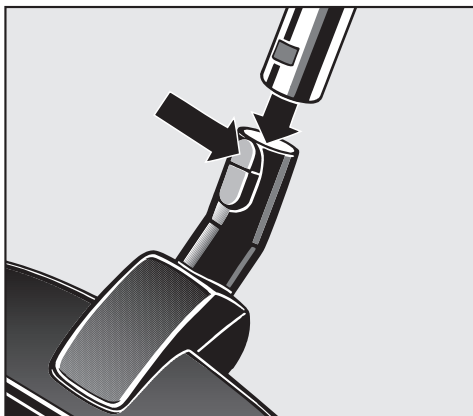

Using the included accessories

The following accessories are included:

- ① **Dust brush with natural bristles**
For cleaning moldings, decorative or carved items, etc.
The head of the dusting brush can be swivelled to attain the best cleaning position.
For dusting particularly delicate objects.

- ② **Upholstery tool**
For cleaning upholstery, mattresses, cushions, curtains, covers, etc.

- ③ **Crevice nozzle**
For cleaning in folds, crevices and corners.

- ④ **Accessory clip for the included accessories**
Position the accessories as indicated with the symbols on the accessory holder.

- Insert the accessory holder either on the hand piece at the handle or on the hose connector of the vacuum cleaner.

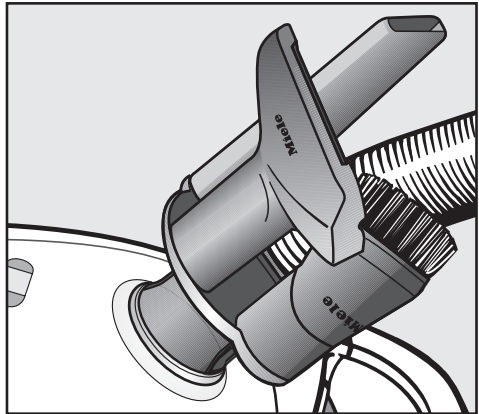
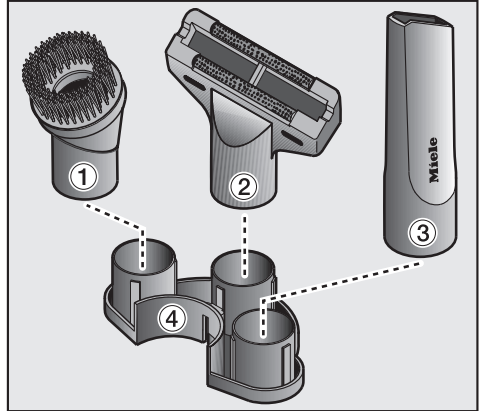

Standard floor brush

(depending on model)

- For safety, when vacuuming stairs it is best to start at the bottom and move upwards.

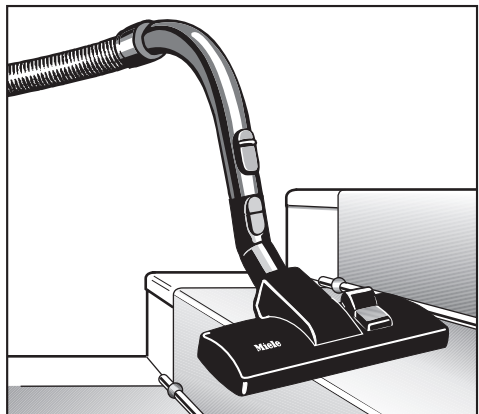

Operation

Power cord

 Unwind the cord completely to aid the vacuum in dissipating heat.

Do not pull or carry by the cord, use the cord as a handle, close a door on the cord, or pull the cord around sharp edges or corners. Do not run the appliance over the cord. Keep the cord away from heated surfaces.

Do not unplug by pulling the cord. To unplug grasp the plug, not the cord.

This appliance is equipped with a power cord reel. Hold the plug when rewinding onto cord reel. Do not allow plug to whip when rewinding.

Unwinding

- Hold the plug and pull out the power cord.

 To reduce the risk of electric shock, the vacuum has a polarized plug (one blade is wider than the other). This plug will fit in a polarized outlet only one way. If the plug does not fit fully in the outlet, contact a qualified electrician. Do not alter the plug in any way. Danger of overheating and damage.

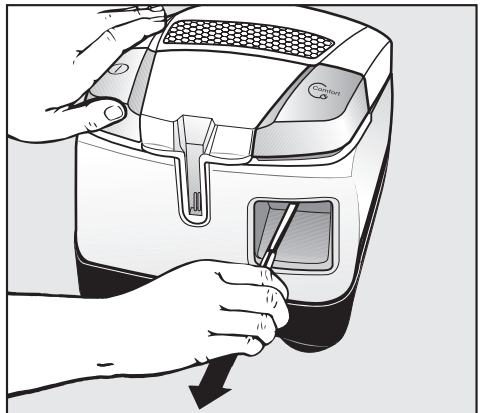

Rewinding

- Unplug the vacuum from the outlet.
- Press the rewind switch - the power cord will rewind automatically. Hold the plug so that it does not whip around when rewinding.

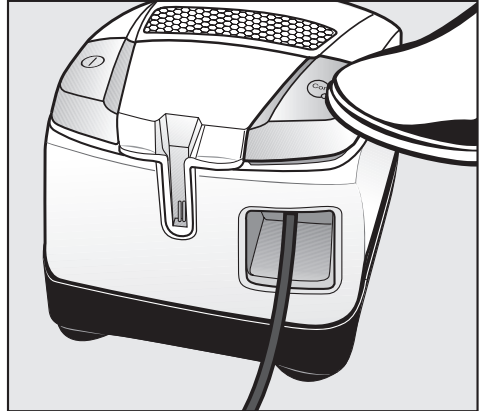

Turning the vacuum on and off

- Press the On/Off  button.

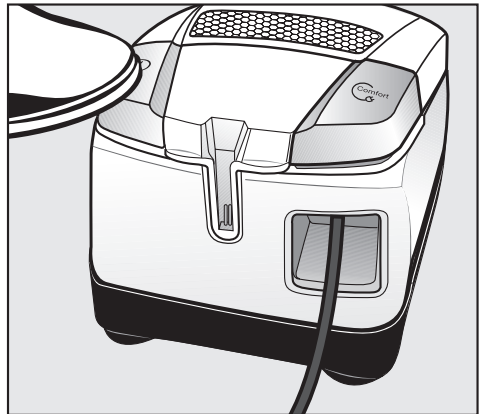

Operation

While vacuuming

- The vacuum cleaner can also stand on its end for vacuuming stairs, drapes etc.

 To prevent static electricity your hand must touch the metal inlay on the underside of the vacuum hand piece. Be certain to continuously touch this inlay when vacuuming fine dust, flour or sawdust as these materials are more likely to create a static discharge. To further prevent static discharge, pull the vacuum along by the hose with one hand while continuing to hold the hand piece in the other hand.







Rotary dial

- Turn the rotary dial to the desired suction power setting.

Adjusting the suction

You can adjust the suction power to suit the type of flooring. By reducing the suction power the floor brush can be pushed easier.

The symbols on the controls indicate the type of use the settings are suitable for:

-  curtains, lightweight fabrics
-  upholstery, cushions
-  thick pile carpets, rugs and runners
-  energy saving, daily vacuuming with low noise level
-  low pile carpets
-  hard flooring and intensive cleaning of carpets

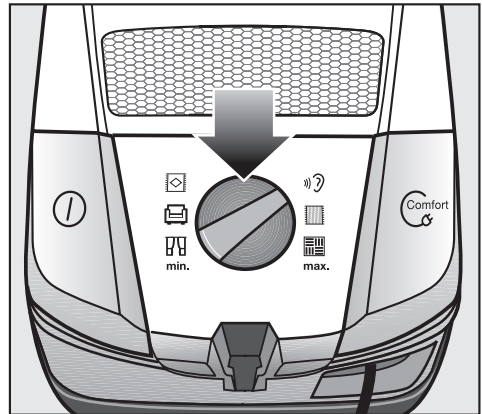

Opening the air inlet valve

(depending on model)

The air inlet valve can be opened to quickly reduce the suction power of the tool being used, e.g. when moving from a carpet to an area rug.

- Open the air inlet valve far enough to reduce the suction power.

Opening the air inlet valve reduces the power to the tool being used.

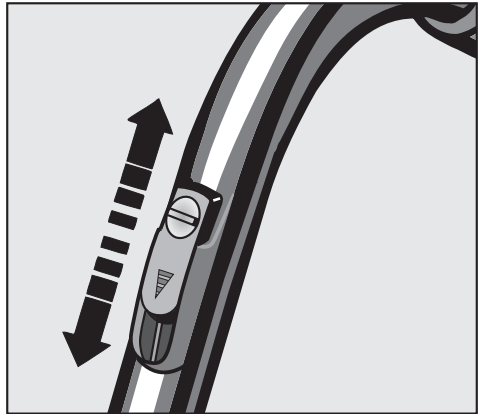
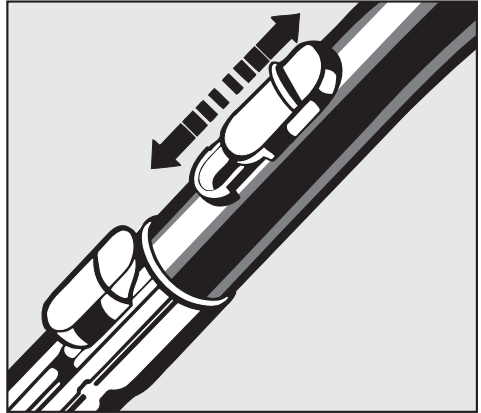

Park-System

(cannot be used with Powerbrush SEB 228 / EB03 and SEB 236 / EB01)

The Park system allows you to conveniently park the wand and floor brush on the vacuum cleaner during brief pauses.

- Insert the lower clip on the floor brush into the slot on the end of the vacuum cleaner from above.

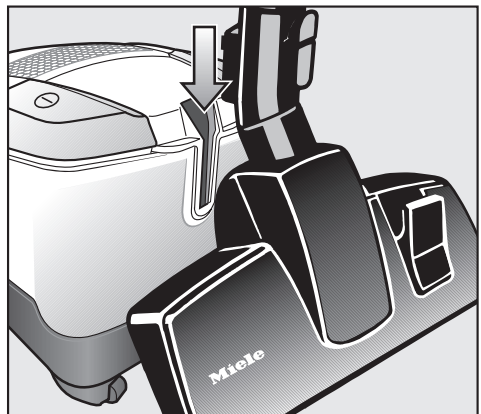

When vacuuming on a sloping surface, e.g. on a ramp, push all telescopic tubing parts completely together.

Maintenance and care

 Turn off and unplug the vacuum cleaner before performing any maintenance work.

The Miele filter system consists of the following three components.

- Dustbag
- Exhaust filter
- Dust compartment filter

Each of these components must be changed periodically to maintain the vacuum cleaner's efficiency.

Only use Miele dustbags, filters and accessories with the "Original Miele" logo. Only then can the suction power of the vacuum cleaner reach its optimum potential creating the best possible cleaning results.

 The use of dustbags made of paper or a similar material, or dustbags with a cardboard retaining plate can lead to serious damage to the vacuum cleaner and possibly voiding the warranty, just as with the use of dustbags without the "Original Miele" logo.

Purchasing new dustbags and filters

Original Miele dustbags and filters can be purchased from an authorized Miele vacuum dealer or by visiting the Miele store at www.mieleusa.com.

Which dustbags and filters are the right ones?

This vacuum cleaner uses Original Miele dustbags Type **F/J/M** and an Original Miele filters, the "Original Miele" Logo will appear on the packaging or directly on the dustbag.

**ORIGINAL
Miele**



An "Air clean" exhaust filter and a dust compartment filter are supplied with every box of Miele dustbags. If you would like to purchase additional Miele filters separately, contact your vacuum dealer or Miele, please quote the model number of your Miele vacuum cleaner to ensure correct parts are ordered. These parts are also available to order from the online Miele store.

The exhaust filter supplied with the vacuum cleaner can be exchanged with another type of Original Miele filter (see "Exchanging exhaust filters").

When to change the dustbag

Change the dustbag when the colored marker in the airflow indicator fills the display.

Miele dustbags are disposable and made to be used only once. Do not attempt to reuse.

Checking the airflow indicator

- Attach the standard floor brush (depending on model) to the vacuum cleaner. Perform this test with the standard floor brush only, since other attachments can affect the function of the airflow indicator.
- Turn the vacuum cleaner on and select the highest power setting.
- Lift the floor brush slightly off the floor. If the marker completely fills the indicator window, the dustbag needs to be changed.

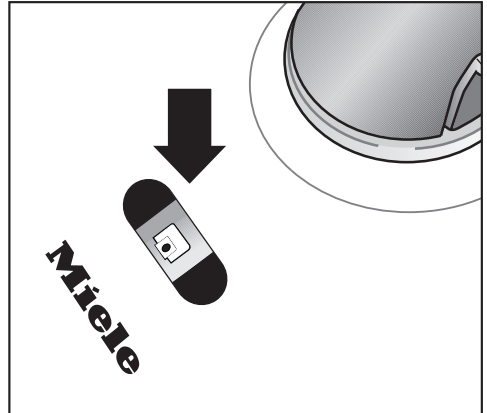

How the airflow indicator works

The airflow indicator is designed to show when the bag is full of common household dust and measures the amount of air flow through the dustbag. Normal household dust is a mixture of dust, hair, carpet fluff, threads, sand, etc.

However, if fine dust, such as drill dust, sand, plaster or flour is vacuumed, the pores of the dustbag may become blocked. The marker will indicate that the bag is "full" even when it is not. The dustbag should be changed as the suction power is greatly reduced.

If the bag is bulging with pet fur, hair, carpet fluff, etc. the indicator may not register "full". This is because the air flow of the dustbag may still be high enough not to activate the marker to show maximum. The dustbag should still be changed.

Maintenance and care

Replacing the dustbag

- Open the dust compartment lid and raise until it clicks into place.

The dustbag has a closing flap which closes automatically when the dust compartment lid is raised to prevent any dust from escaping.

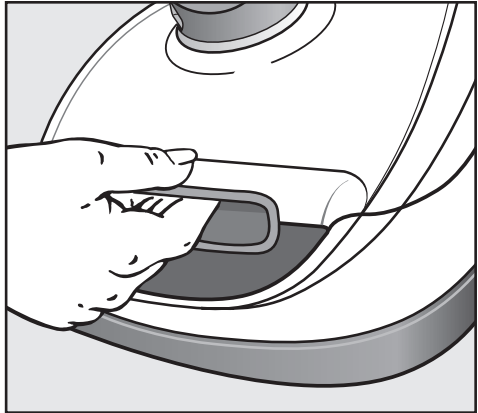

- Grasp the finger grip and pull the dustbag out of the holder.

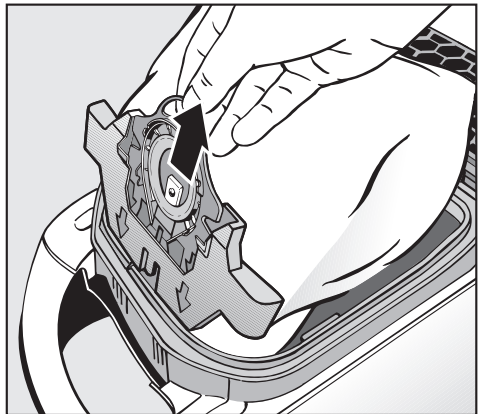

- Insert the new dust bag as far as it will go into the dustbag holder. Do not unfold the dustbag when taking it out of the box.

- Unfold the dustbag in the dust compartment.

- Close the dust compartment lid until it clicks into place. Take care not to catch the dust bag in the lid.

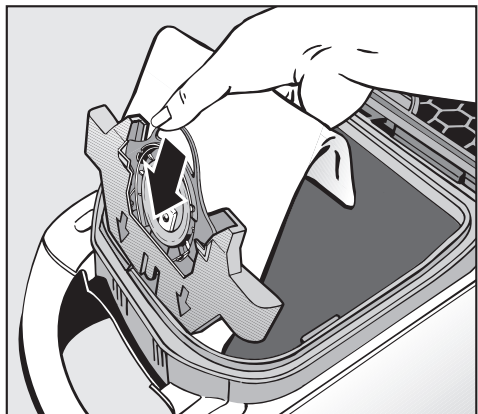

 A empty-operation-barrier will block the dust compartment lid from closing if no dustbag is inserted. Do Not Use Force!

Replacing the exhaust filter

Depending on model, the vacuum cleaner will be equipped with one of the following exhaust filters:

a Air Clean

An "Air Clean" filter is supplied with every box of Miele dustbags. It should be replaced each time a new box of bags is started.

b Active Air Clean SF-AAC 50 (black)

c Active HEPA SF-AH 50 (blue)

An "Active Air Clean" or "Active HEPA" filter should be changed approximately once a year. Change the filter sooner if it is obviously soiled or no longer effective.

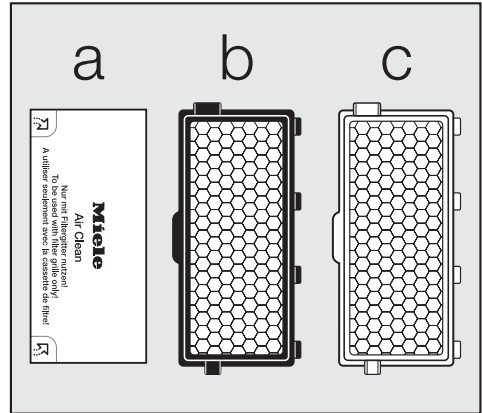

Replacing the "Air Clean" filter

Do not use more than one filter at a time.

- Open the dust compartment lid.
- Open the filter frame and remove the used "Air Clean" filter with the clean corner (see arrow).
- Insert the new filter.

If you wish to replace the Air Clean filter with an Active Air Clean filter or Active HEPA filter see "Maintenance and care - Exchanging exhaust filters".

- Close the dust compartment lid firmly until it clicks into place.

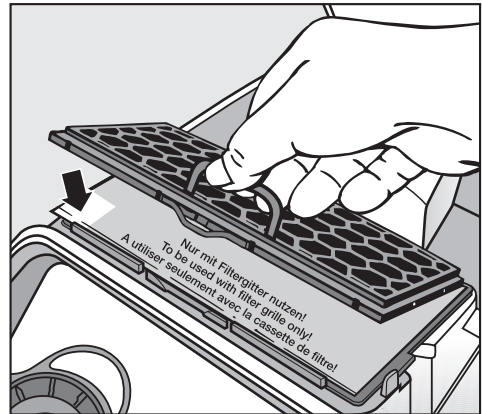

Maintenance and care

Replacing the "Active Air Clean" filter and the "Active HEPA" filter

Do not use more than one filter at a time.

- Open the dust compartment lid.
- Remove the exhaust filter.

- Insert the new filter.

If you wish to replace the Active Air Clean filter or the Active Hepa filter with an Air Clean filter see "Maintenance and care - Exchanging exhaust filters".

- Close the dust compartment lid firmly until it clicks into place.

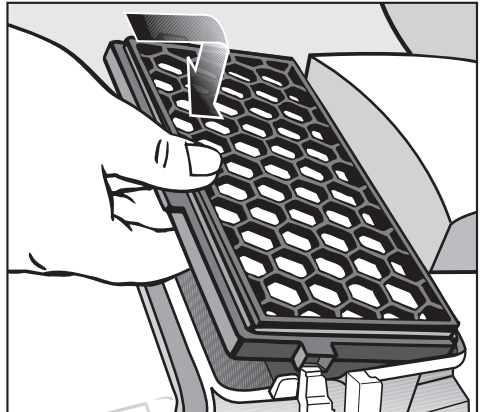
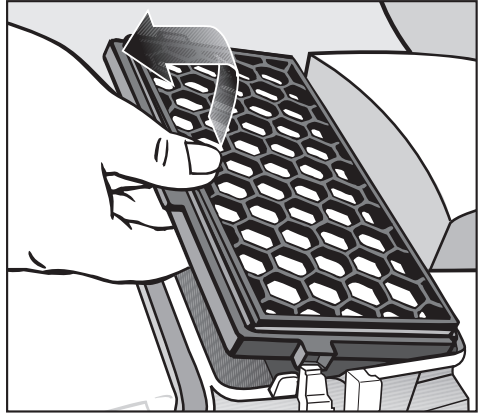

Exchanging exhaust filters

1. If you wish to replace the **a** Air Clean filter with the **b** Active Air Clean filter or the **c** Active HEPA filter, you must remove the filter frame before inserting the new filter.

2. If you use an Air Clean filter **a** you must insert it into a filter frame.

* Filter frame - see "Optional accessories".

Do not use more than one filter at a time.

The Active Air Clean filter can be used instead of the Active HEPA filter and vice versa without any changes.

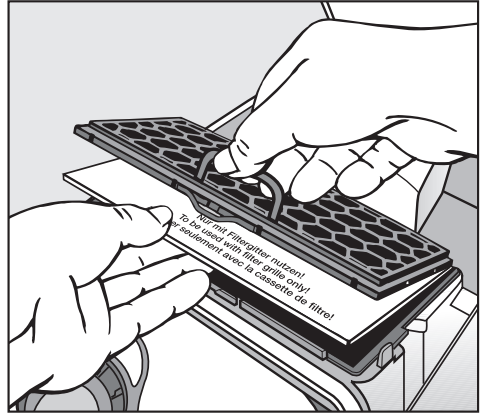
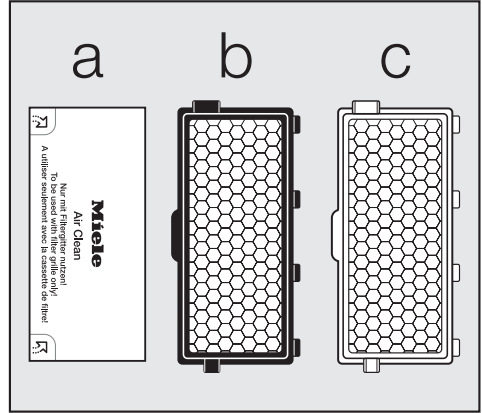

Maintenance and care

When to change the dust compartment filter (motor protection)

Replace the dust compartment filter every time you start a new box of dustbags. A dust compartment filter is supplied with each box of Miele dustbags.

Replacing the dust compartment filter (motor protection)

- Open the dust compartment lid.
- Remove the dustbag.
- Open the filter frame, remove the old filter and replace with a new one.
- Close the filter frame.
- Replace the dustbag.
- Close the dust compartment lid firmly until it clicks into place, making sure the dustbag does not get caught.

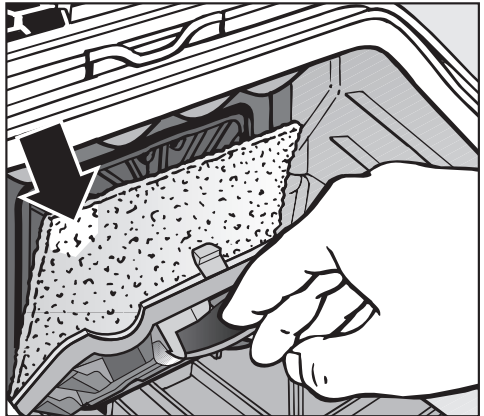

When to change the thread catcher pads of the standard floor brush

(depending on model)

The thread catcher pads on the bottom of the standard floor brush (depending on model) should be checked occasionally. Replace the pads if they appear worn.

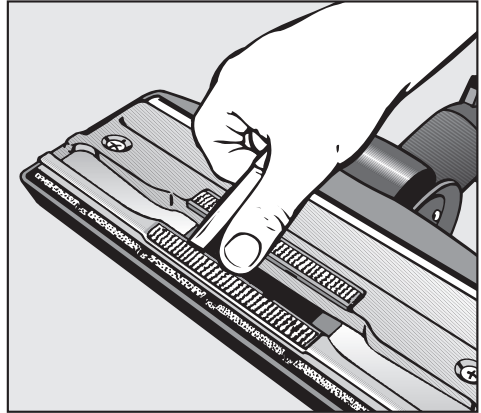

Replacing the thread catchers

- Use a knife or similar object to remove the thread catchers from the slots.
- Insert the new thread catchers.

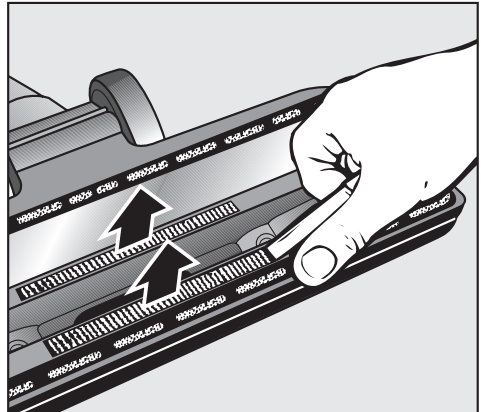

Cleaning the floor brush roller

(not possible with the AirTeQ SBD 650-3 Standard floor brush)

- ① Unlock the roller pin with a coin.
 - ② Push the pin out and remove it.
 - ③ Remove the roller.
- Remove any threads and hair from the roller.
 - Replace roller in the reverse order.

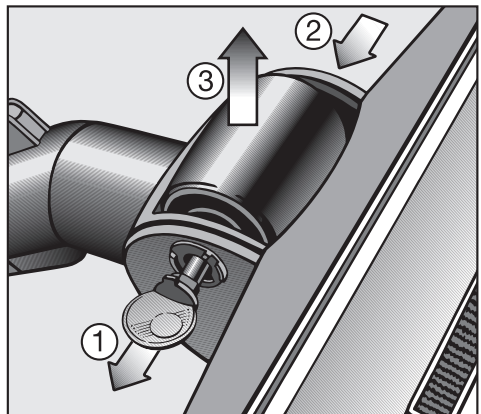

Cleaning and care

 Turn off the vacuum and unplug it from the outlet before performing any maintenance work.

Vacuum cleaner with textile surface

Clean the surface with the dust brush accessory or a damp cloth.

Vacuum cleaner and accessories

The vacuum cleaner and other plastic accessories can be cleaned with a damp cloth or a cleaner suitable for plastics.

 Do not use abrasive, glass or all purpose cleaners! They will damage the surface.

Dust compartment

The dust compartment can, if necessary, be cleaned using a **dry** cloth, dusting brush or a second vacuum to remove any dust.

Monitor the airflow indicator and inspect all filters regularly. Clean or replace them when necessary according to these Operating Instructions.

 Do not submerge the vacuum in water. If moisture gets into the appliance there is the risk of an electric shock.

 Turn off and unplug the vacuum cleaner before performing any maintenance work.

What if the vacuum turns off automatically?

The vacuum has overheated. The temperature limiter automatically turns the vacuum off.

This can occur if, for instance, large articles block the suction tube or when the dust bag is full or contains particles of fine dust. A heavily soiled exhaust or dust compartment filter can also be the cause of overheating. Turn the vacuum off ① and pull the plug from the outlet.

Check for any blockages and allow the vacuum to cool for 30 minutes.

Optional accessories

Observe the cleaning instructions of the floor manufacturer.

Many of these accessories as well as other products can be purchased from the Miele Store at www.Mieleusa.com.

Some models come standard with one or more of the following accessories.

In order to use the Powerbrush with this vacuum you will **also** need:

- Electro telescopic wand SET 220
- Electro suction hose SES 117.

Powerbrush SEB 217-3 (EB02)

The Powerbrush is particularly suitable for cleaning and restoring crushed carpet pile of wall to wall carpeting and floor coverings subject to hard wear, especially in high traffic areas.

Powerbrush SEB 228 (EB03)

This Powerbrush is similar to the SEB 217-3 with the addition of a height adjustable brush, allowing it to also be used on smooth floor surfaces.

Powerbrush SEB 236 (EB01)

This Powerbrush is similar to the SEB 228 except it also includes a headlight and multifunction indicator.

Turbo / Floor brushes

Turbobrush Turbo Comfort - 3

Intended for cleaning short to medium pile carpeting.

Hand Turbobrush Turbo Mini

Intended for vacuuming upholstery, mattresses, car seats, carpeted stairs and other areas inaccessible with the standard Turbobrush.

Floor brush Hard floor - 3

To vacuum sturdy hard floors, e.g. tiles and stone floors.

Floor brush Parquet - 3

Special brush with natural bristles intended for cleaning parquet and laminate floors, especially those susceptible to scratching.

Floor brush Parquet Twister with swiveling head

For cleaning all hard flooring, e.g. parquet and tiles. Especially suitable for vacuuming niches and tight spaces.

Floor brush Parquet Twister XL with swiveling head

For cleaning large areas of hard flooring, e.g. parquet and tiles.

Other accessories

MicroSet

For cleaning small objects and difficult to reach areas (such as PC keyboards, stereo equipment, carved furniture and ornaments, models, etc).

CarCare accessory case

For cleaning car interiors.

Cat&Dog accessory case

For cleaning the homes of pet owners.

HomeCare accessory case

For cleaning your home.

Universal brush

For dusting books, shelves, etc.

Dust brush with natural bristles

For dusting particularly delicate objects.

Radiator brush

For cleaning radiators, narrow shelves or crevices.

Mattress tool

For cleaning deep crevices, mattresses and upholstery.

Crevice nozzle 12" (300 mm)

For cleaning in folds, crevices, corners, etc.

Crevice nozzle 22" (560 mm)

For cleaning hard to reach areas.

Upholstery tool 7 ½" (190 mm)

For cleaning upholstered furniture, mattresses and pillows.

Filters

Active Air Clean filter SF-AAC 50

This charcoal filter absorbs odors from the dust collected in the dustbag.

Active HEPA filter SF-AH 50

This filter are particularly suitable for allergy sufferers and those concerned with a high level of hygiene.

Filter frame

The filter frame is needed if you would like to exchange a Air Clean filter with an Active Air Clean or Active HEPA filter.

Technical Service

After sales service

In the event of a fault which you cannot fix yourself please contact the Miele Service Department at the phone number listed on the back of this booklet.

- Please quote the model type of your appliance.

This can be found on the data plate on the bottom of the vacuum.

Disposal of packing materials

The cardboard box and packing materials protect the appliance during shipping.

Ensure that any plastic wrappings, bags, etc. are disposed of safely and kept out of the reach of children. These items pose a danger of suffocation.

Disposing of the dustbag and filters

These are made from environmentally friendly materials and can be placed in the regular household garbage. However, if the dustbag contains prohibited waste, contact your local waste collection center for disposal instructions.

**Please have the model and serial number
of your appliance available before
contacting Technical Service.**



U.S.A. Miele, Inc.

National Headquarters

9 Independence Way
Princeton, NJ 08540
Phone: 800-843-7231
609-419-9898
Fax: 609-419-4298
www.mieleusa.com

Technical Service & Support Nationwide

Phone: 800-999-1360
Fax: 888-586-8056

TechnicalService@mieleusa.com

Canada Miele Limited

Headquarters and Showroom

161 Four Valley Drive
Vaughan, ON L4K 4V8
Phone: 800-643-5381
905-660-9936
Fax: 905-532-2290
www.miele.ca
professional@miele.ca
(commercial enquiries)

MieleCare National Service

Phone: 800-565-6435
905-532-2272
Fax: 905-532-2292
customercare@miele.ca
(general and technical enquiries)

Germany

Miele & Cie. KG
Carl-Miele-Straße 29
33332 Gütersloh