



C 230

OWNER'S MANUAL

FISHING BOATS
3901 St. Lucie Blvd.
Ft. Pierce, Florida 34946

© 2011 S2 Yachts, Inc.

Safety Information

Your Owner's Manual was written to include safety instructions to ensure safe operation and maintenance of your boat. Safety alerts symbols are used to alert potential personal injury hazards.

DANGER

Indicates a hazardous situation which, if not avoided, will result in death or serious injury.

WARNING

Indicates a hazardous situation which, if not avoided, could result in death or serious injury.

CAUTION

Indicates a hazardous situation which, if not avoided, could result in minor or moderate injury.

NOTICE

Indicates a potentially hazardous situation which, if not avoided, may result in property damage.

All instructions are viewed from the stern looking toward the bow, with starboard (to your right) and port (to your left). A glossary of boating terms is included.

Your boat produces carbon monoxide (CO) and uses flammable fuel. CO will cause BRAIN DAMAGE or DEATH. Carbon monoxide gas (CO) is colorless, odorless and extremely dangerous.

Every precaution has been taken by Pursuit Fishing Boats to reduce the risks associated with death, possible injury and damage from fire or explosion. Your own precaution and good maintenance procedures are necessary in order to enjoy safe operation of your boat.





DANGER

Exposure to carbon monoxide will cause death or serious injury. Avoid direct and prolonged exposure to CO.

Gasoline and other fuels are extremely flammable and highly explosive under certain conditions.

- DO NOT smoke or allow open flame or sparks nearby when fueling.
- DO NOT block fuel vents.
- DO NOT store fuel in any containers or compartments which are not designated for storing fuel.

Specifications

 PURSUIT C 230		<h2>Small Craft Owner's Manual Supplement</h2>	
Boat Manufacturer/Model: Boothersteller/Model:		Constructeur/Modèle du bateau: Costruttore/modello della barca:	
		Pursuit C 230	
Design Category: C-Inshore Categorie de conception: C-à proximité de la côte Categoría de Diseño: C-Costera Konstruktionskategorie: C-Küstennane Gewässer Categoria di progetto: C-Costeira Categoria de Design: C-Perto da Costa		Propulsion Type: Tipo di propulsione: Antriebsart: Tipo de propulsión: Type de propulsion: Tipo propulsão: <div style="text-align: center; border: 1px solid black; padding: 5px; width: fit-content; margin: 0 auto;"> Outboard </div>	
Intended Use: Verwendungszweck: Usage prévu: Utilizzo previsto: Uso previsto: Utilização:	Hull Identification Number: Rumpfunner: Nembro d'identification de coque: Nembro identificazione scafo: Numero de Identificación del Casco: Número de Identificação do Casco:		
Recreation	HIN Label		
Maximum Recommended Load: Charge maximale recommandée: Carga Máxima recomendada: Empfohlene Beladung Maximum: Carico massimo ammesso: Carga Máxima Recomendada:		 MAXIMUM	
		<div style="border: 1px solid black; padding: 5px; display: inline-block;"> 864 </div> kg.	
Recommended Number of Persons: Nombre de personnes recommandé: Número recomendado de personas: Empfohlene Personenanzahl: Omologazione al trasporto di n. persone: Número de Pessoas Recomendado:		Maximum Rated Engine Power: Puissance nominale maximale du moteur: Potencia máxima del motor: Maximale Motorleistung: Massima potenza nominale motore: Máxima potência nominal do motor:	
MAXIMUM  = <div style="border: 1px solid black; padding: 5px; display: inline-block;"> 7 </div>		MAXIMUM  = <div style="border: 1px solid black; padding: 5px; display: inline-block;"> 187 </div> kw.	
Engine Installed, Manufacturer, Model and Number(s): Moteur installé, Fabricant, modèle et numéros(s): Motor instalado, Fabricante, modelo y número(s): Motor installiert, Hersteller, modell, nummer(en): Motore installato, Costruttore, modello e numero(s): Motor Instalado, Fabricante, Modelo e Número(s):			
1. _____ 2. _____			
Mass of Craft (Approximate) Masses de Navire (Approximatives) Peso de la embarcación (aproximado) Gewicht des Bootes (Nährungswert) Massa dell'imbarcazione (approssimativa) Massa da Embarcação (Aproximada)		With Largest Equipped Engine and permanently attached items, plus full water and fuel, plus maximum recommended load: Avec le plus grand moteur équipé et systèmes en liaison permanente, plus pleine charge d'eau et de carburant, plus charge maximale recommandée: Con el mayor motor equipado y elementos permanentemente instalados, más combustible y agua, más la carga máxima recomendada: Mit größter Motorausführung und fest installiertem Inventar sowie vollen Wasser- und Kraftstofftanks und empfohlener Maximalbeladung: Con il motore di maggiore cilindrata, attrezzature permanenti, più rifornimento di acqua e carburante e carico massimo ammesso: Com o maior motor instalado e os equipamentos permanentes, mais a capacidade máxima de água e combustível, mais a carga máxima recomendada:	
With Largest Equipped Engine and permanently attached items: Avec le plus grand moteur équipé et systèmes en liaison permanente: Con el mayor motor equipado y elementos permanentemente instalados: Mit größter Motorausführung und fest installiertem Inventar: Con il motore di maggiore cilindrata e attrezzature permanenti: Com o maior motor instalado e os equipamentos permanentes:		<div style="border: 1px solid black; padding: 5px; display: inline-block;"> 3004 </div> kg.	
<div style="border: 1px solid black; padding: 5px; display: inline-block;"> 2077 </div> kg.		Trailerable Weight (engine, fuel and water, batteries and options): Masse pour remorquage (moteur, carburant et eau, batteries et options): Peso remolcable (motor, combustible y agua, baterías y opciones): Auf Anhänger verladbares Gewicht (Motor, Kraftstoff und Wasser, Batterien und Sonderausstattung): Peso rimorchiabile su strada (motore, combustibile e acqua, batterie ed accessori): Peso Rebocável (motor, combustível e água, baterias e opções):	
		<div style="border: 1px solid black; padding: 5px; display: inline-block;"> 2409 </div> kg.	
<i>Note: Information obtained from 2008 CE Certificate and/or Specification Sheet 6/18/07 rev.D</i>			

10/11/2007

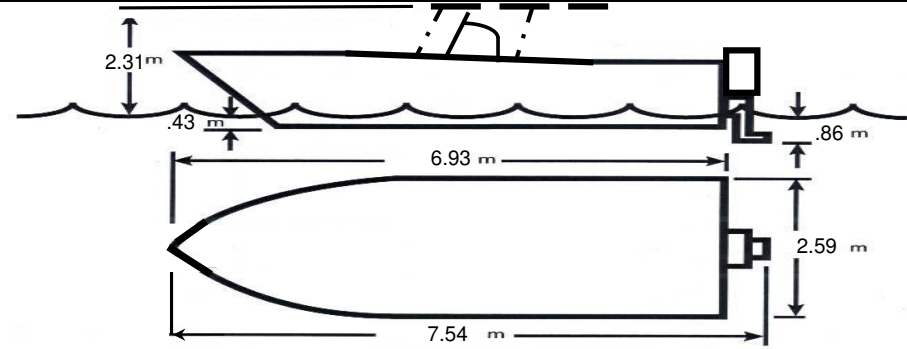
 C 230		<h2>Small Craft Owner's Manual Supplement</h2>	
			
EN		DE	
Fuel Tank Capacity (0.73kg/Liter): 398 Liters Fuel Type: <input checked="" type="checkbox"/> Gasoline N/A Diesel Oil Tank Capacity: N/A Liters Oil Type: 10-40 Water Tank Capacity (1kg/Liter): 9 Liters Holding Tank Capacity: N/A Liters		Kraftstofftankkapazität (0,73 kg/Liter): 398 Liter Kraftstoffart: <input checked="" type="checkbox"/> Benzin N/A Diesel Öltankkapazität: N/A Liter Ölsorte: 10-40 Wassertankkapazität (1kg/Liter): 9 Liter Speichertankkapazität: N/A Liter	
Number and Type of Fire Extinguishers: (1) B,C Number and Type of CO Detectors: 0 N/A = Not Applicable		Feuerlöscheranzahl und -typ: (1) B,C Rauchdetektoranzahl und -typ: 0 n.z. = nicht zutreffend	
FR		IT	
Contenance réservoir carburant (0,73kg/litre): 398 litres Type de carburant: <input checked="" type="checkbox"/> gasoil N/A diesel Contenance réservoir d'huile: N/A litres Type d'huile: 10-40 Contenance réservoir de'eau (kg/litre): 9 litres Contenance réservoir de rétention: N/A Nombre et type d'extincteurs: (1) B,C Nombre et type de détecteurs de fumée: 0 N/A = non applicable		Capacità serbatoio carburante (0,73kg/l): 398 litri Tipo carburante: <input checked="" type="checkbox"/> Benzina N/A Diesel Capacità serbatoio olio: N/A litri Tipo olio: 10-40 Capacità serbatoio acqua (1kg/l): 9 litri Capacità cassa di zavorra: N/A litri Numero e tipo di estintori: (1) B,C Numero e tipo di rivelatori di esalazioni: 0 N/A = non pertinente	
ES		PT	
Capacidad del Depósito de Combustible (73Kg/Litro): 398 Litros Tipo de Combustible: <input checked="" type="checkbox"/> Gasolina N/A Diesel Capacidad del Depósito de Aceite: N/A Litros Tipo de Aceite: 10-40 Capacidad del Depósito de Agua (1Kg/Litro): 9 Litros Capacidad del Tanque de Retención: N/A Litros Número y Tipo de Extintores de Incendios: (1) B,C Número y Tipo de Detectores de Humos: 0 N/A = no aplicable		Capacidade do Depósito de Combustível: (0,73kg/Litro): 398 Litros Tipo de Combustível: <input checked="" type="checkbox"/> Gasolina N/A Gasóleo Capacidade do Depósito de Óleo: N/A Litros Tipo de Óleo: 10-40 Capacidade do Depósito de Água: (1kg/Litro): 9 Litros Capacidade do Depósito Provisório: N/A Litros Número e Tipo de Extintores de Incêndio: (1) B,C Número e Tipo de Detectores de Fumo: 0 N/A = Não Aplicável	

Note: Information obtained from 2008 CE Certificate and/or Specification Sheet 6/18/07 rev.D

Specifications

 PURSUIT C 230	<h2>Small Craft Owner's Manual Supplement</h2>	
<p>EN</p> <p>Locate and Identify:</p> <ul style="list-style-type: none"> A) Fuel Tank B) Fuel Tank Filling Point C) Oil Tank (N/A) D) Oil Tank Filling Point (N/A) E) Oil Tank Emptying Point (N/A) F) Water Tank G) Water Tank Filling Point H) Holding Tank I) Holding Tank Emptying Point (N/A) J) Seacocks K) Through-Hull Fittings L) Fire Extinguisher M) Carbon Monoxide Detector (N/A) N) Escape Hatch (N/A) O) Fire Escapes(N/A) P) Life Raft Stowage Q) Safety Equipment R) Anchor Strong Points S) Mooring Strong Points T) Towing Strong Points 	<p>ES</p> <p>Localizar e identificar:</p> <ul style="list-style-type: none"> A) Depósito de Combustible B) Punto de Carga del Depósito de Combustible C) Depósito de Aceite (N/A) D) Punto de Carga del Depósito de Aceite (N/A) E) Punto de Descarga del Depósito de Aceite (N/A) F) Depósito de Agua G) Punto de Carga del Depósito de Agua H) Tanque de Tetención I) Punto de Descarga del Tanque de Tetención (N/A) J) Válvula de Toma de Agua de Mar K) Accesorios Pasantes del Casco L) Extintor de Incendios M) Detector de Monóxido de Carbono (N/A) N) Escotilla de Seguridad (N/A) O) Escalera de Incendios (N/A) P) Almacenamiento de balsas salvavidas Q) Equipos de seguridad R) Puntos fuertes de anclaje S) Puntos fuertes de amarre T) Puntos fuertes de remolque 	<p>IT</p> <p>Localizzazione e identificazione dei componenti:</p> <ul style="list-style-type: none"> A) Serbatoio carburante B) Bocchettone di riempimento serbatoio carburante C) Serbatoio olio (N/A) D) Bocchettone di riempimento serbatoio olio (N/A) E) Scarico serbatoio olio (N/A) F) Serbatoio acqua G) Bocchettone di riempimento serbatoio acqua H) Cassa zavorra I) Scaric cassa zavorra (N/A) J) Valvole di presa acqua dal mare K) Raccorderia passante nello scafo L) Estintore M) Rivelatore monossido di carbonio carbonio (N/A) N) Boccaporto di sfuggita (N/A) O) Uscite di sicurezza (N/A) P) Stivaggio zattera di salvataggio Q) Dotazioni di sicurezza R) Punti di attacco per l'ancoraggio S) Punti di attacco per l'ormeggio T) Punti di attacco per il traino

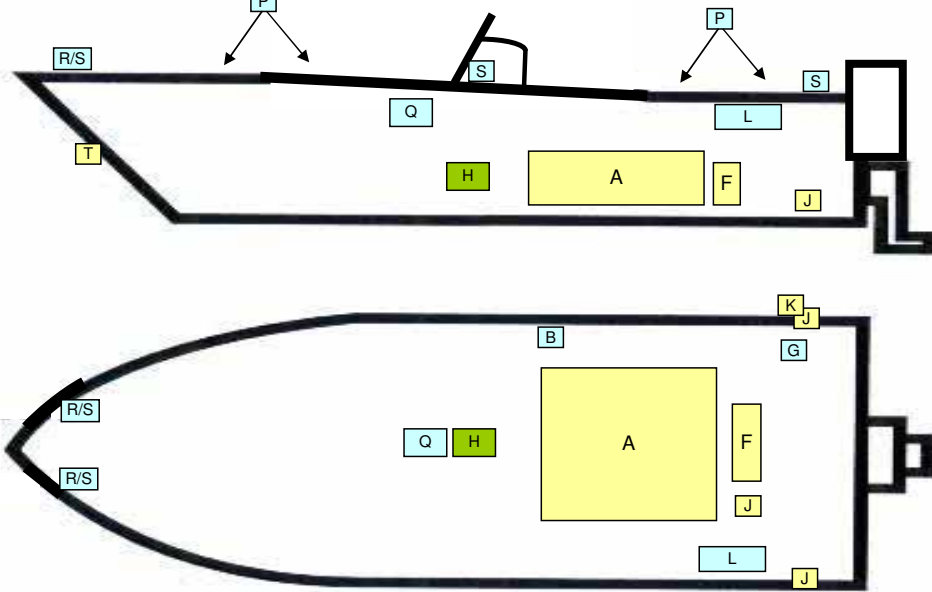
 PURSUIT C 230	<h2 style="text-align: center;">Small Craft Owner's Manual Supplement</h2>	
		
<p>FR</p> <p>Repérez et identifiez:</p> <ul style="list-style-type: none"> A) Réservoir de carburant B) Point de remplissage réservoir de carburant C) Réservoir d'huile (N/A) D) Point de remplissage réservoir d'huile (N/A) E) Point de vintage réservoir d'huile (N/A) F) Réservoir d'eau G) Point de remplissage réservoir d'eau H) Réservoir de rétention I) Point de vidange réservoir de rétention (N/A) J) Prises d'eau à la mer K) Raccords traversant la coque L) Extincteur M) Détecteur de monoxyde de carbone (N/A) N) Escotille d'évacuation (N/A) O) Echelles de sauvetage (N/A) P) Arrimage du radeau de sauvetage Q) Equipement de sécurité R) Points d'ancrage S) Points d'amarrage T) Points de remorquage 	<p>DE</p> <p>Position and Beschreibung:</p> <ul style="list-style-type: none"> A) Kraftstofftank B) Kraftstofftankfüllpunkt C) Öltank (n.z.) D) Öltankfüllpunkt n.z.) E) Öltankablasspunkt (n.z.) F) Wassertank G) Wassertankablasspunkt H) Speichertank I) Speichertankablaßpunkt (n.z.) J) Flutventile K) Rumpfdurchgangsambauten L) Feuerlöscher M) Kohlenmonoxid-detektor (n.z.) N) Notausstieg (n.z.) O) Reuerrettungswege (n.z.) P) Rettungsflöbunterbringung Q) Sicherheitsausrüstung R) Ankerpunkte S) Vertäuungspunkte T) Abschlepppunkte 	<p>PT</p> <p>Localizar e Identificar:</p> <ul style="list-style-type: none"> A) Depósito de Combustível B) Ponto de Enchimento do Depósito de Combustível C) Depósito de Óleo (N/A) D) Ponto de Enchimento do Depósito de Óleo (N/A) E) Ponto de Esvaziamento do Depósito de Óleo (N/A) F) Depósito de Água G) Ponto de Enchimento do Depósito de Água H) Depósito Provisório I) Ponto de Esvaziamento do Depósito Provisório (N/A) J) Torneiras de tomada de água do mar K) Acessórios de Todo o Casco L) Extintor de Incêndios M) Detector de Monóxido de Carbono (N/A) N) Escotilha de Fuga (N/A) O) Saídas de Incêndio (N/A) P) Acondicionamento do Barco Salva-vidas Q) Equipamento de Segurança R) Pontos Fortes da Ancoragem S) Pontos Fortes da Amaragem T) Pontos Fortes da Reboagem

General Information

Boat Information

Fill out the following information and leave it in your PURSUIT Owner's Manual. This information will be important for you and PURSUIT service personnel to know, if and when you may need to call PURSUIT for technical assistance or service.

Boat	
Model:	Hull Serial #:
Purchase Date:	Delivery Date:
Ignition Keys #	Registration #:
Draft:	Weight:
Engine(s)	
Make:	Model:
Port Serial #:	Starboard Serial #:
Transmission(s) (Inboard)	
Make:	Model:
Port Serial #:	Starboard Serial #:
Ratio:	
Outdrive(s) (Inboard/Outboard)	
Make:	Model:
Port Serial #:	Starboard Serial #:
Propeller(s)	
Make:	Blades:
Diameter/Pitch:	Other:
Generator	
Make:	Model:
Serial #:	kW
Dealer	Pursuit
Name:	Phone:
Dealer/Phone:	Representative:
Salesman:	Address:
Service Manager:	
Address:	

PURSUIT Fishing Boats reserves the right to make changes and improvements in equipment, design and vendor supplied equipment at any time without notification.

Warranty and Warranty Registration Cards

The PURSUIT Limited Warranty Statement is included with your boat. It has been written to be clearly stated and easily understood. If you have any questions after reading the warranty, please contact PURSUIT Customer Relations.

PURSUIT, engine manufacturers, and the suppliers of major components maintain their own manufacturer's warranty and service facilities. It is important that you properly complete the warranty registration cards included with your boat and engine(s) and mail them back to the manufacturers to register your ownership. This should be done within 15 days of the date of purchase and before the boat is put into service. A form for recording this information is provided at the beginning of this manual. This information will be important for you and service personnel to know, if and when you may need service or technical information.

The boat warranty registration requires the **Hull Identification Number "HIN"** which is located on the starboard side of the transom, just below the rub rail. The engine warranty registration requires the engine serial number(s). Please refer to the engine owner's manual for the location of the serial number(s).

Federal Boat Safety Act

All boat manufacturers are required by the Federal Boat Safety Act of 1971 to notify first time owners in the event any defect is discovered "which creates a substantial risk of personal injury to the public." It is essential that we have your warranty registration card complete with your name and mailing address in our files so that we can comply with the law if it should become necessary.

Product Changes

PURSUIT is committed to the continuous improvement of our boats. As a result, some of the equipment described in this manual or pictured in the catalog may change or no longer be available.

PURSUIT reserves the right to change **standard equipment, optional equipment and specifications without notice or obligation.** If you have questions about the equipment on your PURSUIT, please contact PURSUIT Customer Relations.

Transferring the Warranty

For a Transfer fee, S2 Yachts will extend warranty coverage to subsequent owners of PURSUIT models for the duration of the original warranty period. Please refer to the PURSUIT Limited Warranty Statement for the procedure to transfer the warranty. To take advantage of this program, notification of the change of ownership, including the new owner's name, address and telephone number together with the appropriate fee, must be sent to PURSUIT Fishing Boats, Customer Relations Department, 3901 St. Lucie Boulevard, Ft. Pierce, Florida 34946, within 30 days of the date of resale.

S2 Yachts will confirm, in writing, that the transfer of the warranty has taken place. After which, the transferee will be treated as the original purchaser as outlined in the PURSUIT Limited Warranty Statement.

Owner/Operator Responsibilities

Registration and Documentation

Federal law requires all undocumented vessels equipped with propulsion machinery be registered in the state of principal use. A certificate of documentation will be issued upon registration. These registration numbers must be displayed on your boat. The owner/operator of a boat must carry a valid certificate of registration whenever the boat is in use. When moved to a new state of principal use, the certificate is valid for 60 days.

In order to be valid, the numbers must be installed to the proper specifications. Check with your dealer or state boating authority for numbering requirements. The Coast Guard issues the certificate of number in Alaska; all others are issued by the state.

General Information

Insurance

In most states the boat owner is legally responsible for damages or injuries the boat causes. Responsible boaters carry adequate liability and property damage insurance for their boat. You should also protect the boat against physical damage and theft. Some states have laws requiring minimum insurance coverage. Contact your dealer or state boating authority for information on the insurance requirements in your boating area.

Reporting Boating Accidents

All boating accidents must be reported by the owner or operator of the boat to the proper marine law enforcement authority for the state in which the accident occurred. Immediate notification is required if a person dies or disappears as a result of a recreational boating accident.

If a person dies or there are injuries requiring more than first aid, a formal report must be filed within 48 hours.

A formal report must be made within 10 days for accidents involving more than \$500.00 damage or the complete loss of a boat.

A "Boating Accident Report" form is located near the back of this manual to assist you in reporting an accident. If you need additional information regarding accident reporting, please call the Boating Safety Hotline, 800-368-5647 or uscgboating.org.

Education

If you are not an experienced boater, we recommend the boat operator and other people that normally accompany the operator, enroll in a boating safety course. Organizations such as the U.S. Power Squadrons, United States Coast Guard Auxiliary, State Boating Authorities and the American Red Cross offer excellent boating educational programs. These courses are worthwhile even for experienced boaters to sharpen your skills or bring you up to date on current rules and regulations. They can also help in providing local navigational information when moving to a new boating area. Contact your dealer, State Boating Authority or the Boat-

ing Safety Hotline, 800-368-5647 or uscgboating.org for further information on boating safety courses.

Required Equipment

U.S. Coast Guard regulations require certain equipment on each boat. The Coast Guard also sets minimum safety standards for vessels and associated equipment. To meet these standards some of the equipment must be Coast Guard approved. "Coast Guard Approved Equipment" has been determined to be in compliance with USCG specifications and regulations relating to performance, construction or materials. The equipment requirements vary according to the length, type of boat, and the propulsion system. Some of the Coast Guard equipment is described in the Safety Equipment Section of this manual. For a more detailed description, obtain "Federal Requirements and Safety Tips for Recreational Boats" by contacting the Boating Safety Hotline 800-368-5647, uscgboating.org or your local marine dealer or retailer.

Some state and local agencies go beyond USCG regulations or impose similar equipment requirements on waters that do not fall under Coast Guard jurisdiction. Contact your dealer or local boating authority, they can provide you with additional information for the equipment requirements for that boating area.

Propulsion Systems

1.1 General

Your Pursuit boat is designed to be powered with a 2-cycle or 4-cycle outboard engine.

Each manufacturer of the various outboard engines provides an owner's information manual which includes its limited warranty statement with its product. It is important you read and understand the information and become familiar with the warranty, operation and maintenance of the engines and drive systems.

NOTICE

DO NOT attempt to service any part of the outboard or boat systems unless you are familiar or qualified to do so. Do not use parts which are not designed for a marine application.

WARNING

MOVING PARTS HAZARD.
Contact with moving parts can entangle, cut and cause death or serious injury. **DO NOT** get close enough to make contact with any running machinery moving parts, i.e., engine or propeller. Contact can result in loss of body parts, strangulation, burns and/or severe loss of blood resulting in death or serious injury.

NOTICE

Use only the fuel recommended by the engine manufacturer. Use of old, contaminated fuel can cause the engine to malfunction or severe damage.

1.2 Saltwater Application

Each outboard engine is a complete drive system with the gear case (transmission) forward of the propeller and connected to the power head with a vertical drive shaft. Other than the routine maintenance outlined in the engine owner's manual, there is little to be concerned with unless the boat is to be kept in saltwater for extended periods. Marine growth will occur when components are left in the water for extended periods and can cause poor performance or permanent damage to the exposed components. The type of growth and how quickly it occurs is relative to the water conditions in your boating area. Water temperature, pollution, current, etc. can have an effect on marine growth.

Galvanic corrosion is the corrosion process occurring when different metals are submerged in an electrolyte. Sea water is an electrolyte and submerged engine components must be properly protected. Outboard engines are equipped with sacrificial anodes to help prevent galvanic corrosion problems. The anodes must be monitored and replaced as necessary. For locations and maintenance, refer to the engine owner's manual.

When leaving the boat in the water, tilt the motors as high as possible to decrease the risk of marine growth around the cooling inlets, propeller and exhaust ports and damage from galvanic corrosion.

⚠ CAUTION

DO NOT use copper-based coatings or any coatings not approved for use with aluminum. Some paint manufacturers claim their paints are safe for aluminum. Copper components and copper-based paints can cause severe corrosion to aluminum. DO NOT use copper-based paints. Mercury or mercury-based compounds that come into contact with aluminum will result in severe corrosion.

1.3 Engine Lubrication

4-cycle engines have an oil sump in the crankcase. The oil type, grade and level must be followed in accordance with the engine manufacturer's recommendation. It is normal for 4-cycle engines to consume a small amount of oil. Check the oil level before each use and change it following the engine manufacturer's recommendation.

2-cycle outboard engines are lubricated by an oil injection system. Check the oil level before each use and use only type specified by the engine manufacturer. Also monitor the oil level by checking the gauge in the helm or visually checking the oil level in the tank by using the reference marks on the tanks. Refer to the engine owner's manual for oil specifications and additional information on the oil injection system. Refer to the Fuel System Section.

⚠ NOTICE

Use only the oil recommended by the engine manufacturer, and monitor the oil level. Use of any other type of oil can cause the engine to malfunction or severe damage.

1.4 Engine Cooling System

Outboard engines are raw water (sea water) cooled. Water is pumped through the water inlets, circulated through the engine block, and expelled with the exhaust through exhaust port, water port and the propeller hub. The water pump uses a small impeller made of synthetic rubber. The impeller and water pump cannot run dry for more than a few seconds. In most outboard engines, some cooling water is diverted through ports below the engine cowling. This allows the operator to visually check the operation of the cooling system. When the engine is started, make sure a steady stream of water is present.

⚠ CAUTION

DO NOT operate an engine out of the water, even momentarily. Water must be supplied to the cooling system of the power head and water pump, or serious damage will result. If it is necessary to run the engine out of the water, connect it to a engine flush attachment design for your specific engine.

If the boat is used in salt or badly polluted water, flush the engines after each use to reduce corrosion. Refer to the engine owner's manual for the proper engine flushing procedure.

1.5 Propellers

The propellers convert the power of the engines into thrust. Propellers vary in style, diameters and pitch. The best set for your needs will depend on your application and expected average load. Propeller sizes are identified by two numbers stamped on the prop in sequence; the first is the diameter and the second is the pitch (example 14 x 21). Pitch is the theoretical distance the propeller will travel in one rotation. Repair or replace a propeller immediately if it has been damaged. A damaged propeller can cause

vibration that can be felt in the boat and can damage the engine gear case. Refer to the engine owner's manual for information on propeller removal and installation.

1.6 Engine Instrumentation

The helm station is equipped with a set of engine instruments and alarms. The instruments allow the operator to monitor the operational conditions of the engines. Monitoring the instrumentation allows the operator to operate the engines most efficiently and prevent serious costly damage. The instrumentation is unique to the type of outboard engines installed on your Pursuit. Your boat may not be equipped with all of the following gauges.

Some models may be equipped with Yamaha Command Link Integrated Information System®. Refer to the Yamaha manuals for information on the operation of this system.

Tachometer

The tachometer displays the speed of the engine in revolutions per minute (RPM). This speed is not the boat speed or the speed of the propeller. The tachometer may not register zero with the key in the "OFF" position.

NOTICE

DO NOT exceed maximum recommended engine RPM. Exceeding, maintaining or close to maintaining maximum can reduce engine life.

Speedometer

The speedometer indicates the speed of the boat in miles per hour (MPH). Most speedometers measure the water pressure against a small hole in a pick-up tube located in the engine lower unit or from GPS in a Yamaha® installation.

Temperature Warning

The temperature warning indicates the temperature of the engine. A sudden increase in the temperature could indicate an obstructed water inlet or an impeller failure.

NOTICE

Continued operation of an overheated engine will cause severe engine damage. If the engine overheats, shut off the engine, investigate the problem and correct it.

Fuel Gauge

The fuel gauge indicates the approximate fuel level in the fuel tanks. This gauge is a relative indication of the fuel supply available; it is not a calibrated instrument. On Yamaha equipped boats, fuel level is displayed in the speedometer.

Voltmeter

The voltmeter displays the voltage for the battery and the charging system. The normal voltage for a full charged battery is 12.6 volts with the engine(s) off and 13 to 14.5 volts with the engine(s) running.

Hourmeter

The hourmeter keeps a running total of engine hours while operating.

Tilt/Trim Gauge

The tilt/trim gauge monitors the position of the outboard engine. The upper range of the gauge indicates the tilt, which is used for shallow water operation, trailering and to keep the gear case out of the water. The lower range indicates the trim position. Trim is used to adjust the hull angle while operating your boat on plane. Refer to the engine owner's manual for more information on the operation of the outboard power tilt and trim.

Engine Alarms

Most outboards are equipped with an audible alarm system mounted in the helm area to monitor selected critical engine systems and functions. The alarm will sound if one of these systems begins to fail. Refer to the engine owner's manual for information on the alarms installed with your engines.

CAUTION

If an engine alarm sounds, shut off the engine, investigate the problem and correct it.

Fuel Management

Fuel management systems are standard equipment with some outboard engines. On Yamaha® engines, the fuel management gauge is a multifunction gauge used to monitor fuel consumption of the engines. If your boat is equipped with this system, refer to the engine or fuel management manual.

Instrument Maintenance

Electrical system, instruments and ignition circuitry are protected by a circuit breaker or fuse located on the engine. The ignition switches and all instruments, controls, etc. must be protected from the weather when not in use. Excessive exposure can lead to gauge and ignition switch failures.

Moisture may fog the inside of the gauge lens. Turning the gauge lights on will help dry the lenses. Fogging will normally not harm the gauges, but if the fogging continues and moisture accumulates, the excess water can damage the gauges. The gauges are designed with drain holes to reduce the accumulation of moisture. Make sure that if a gauge is removed, it is reinstalled with the drain holes in the proper position.

Helm Systems

2.1 General

The helm controls consist of engine throttle and shift controls, steering system, trim tab control switches and the optional spotlight control.

Each manufacturer of the control components provides an owner's manual with its product. It is important that you read, understand and become familiar with the proper care and operation of all control systems.

WARNING

LOSS OF CONTROL AND UNSAFE BOAT HAZARD

Hazard from improper securing of helm is hazardous and can cause death or serious injury from sudden loss of control. Make sure the helm is secure before getting underway and during transporting the boat.

2.2 Engine Throttle and Shift Controls

The shift and throttle controls on your boat may vary depending on the engines. The following control description is typical to most outboard remote controls. Refer to the engine or control manuals for specific information on the controls installed on your Pursuit.

The helm on your Pursuit is designed for a side mount control with a single gear shift and a throttle lever for the engine; a position for neutral (straight up and down), forward position (first detent forward of neutral) and reverse position (the first detent aft of neutral). Advancing the control lever beyond the shift range will advance throttle, forward or reverse. Each control is equipped to allow the engine to be operated above idle RPM while in neutral for cold starting or warming up.

CAUTION

Avoid possible injury or engine damage when shifting:

- **Pause in neutral before shifting from FORWARD to REVERSE, or REVERSE to NEUTRAL.**
- **DO NOT shift into reverse while the boat is traveling forward at speed.**
- **Keep area around shifter control clear of obstructions.**

See your Pursuit dealer for necessary control and cable adjustments. If the starter for either engine engages with the shift controls in any position other than neutral, the neutral safety switch is not functioning properly and must be repaired before using your boat.

2.3 Neutral Safety Switch

Every control has a neutral safety switch to prevent the engine from being started while in gear. Control or cable adjustments must be performed if the engine will start in forward or reverse.

Test the neutral safety switch periodically to ensure they are operating. To test the neutral safety switch; tilt the engine down and move the shift lever to the forward position, past first detent. **DO NOT** advance past the idle position. Turn the ignition key to the start position. The starter should not engage. Repeat test with the shift lever in reverse and the engine throttle at idle, the starter should not engage. If the engine starts in gear during this test, immediately move the control levers to the neutral position and turn the engine off. Ejection or sudden loss of control can occur if an engine can start in gear and neutral safety switch system does not function properly.

⚠ WARNING

Test the neutral safety switch periodically. If the switch is not operating properly, **DO NOT** use the boat. Contact your Pursuit Dealer and have it repaired. An inoperable neutral safety switch can allow the engine to start in **FORWARD** or **REVERSE** causing sudden boat movement, throwing the operator and passengers off balance and possibly overboard.

⚠ WARNING**LOSS OF CONTROL AND UNSAFE BOAT HAZARD**

A neutral safety switch that does not function properly can cause death or serious injury. **DO NOT** operate the boat if the switch does not function properly.

2.4 Engine Power Tilt and Trim

All outboard engines used on your boat have a tilt and trim feature. The tilt and trim switches are usually built into the engine shift and throttle controls and allow the operator to control the position of the outboards from the helm. Moving the gear cases closer to the boat transom is called trimming “in” or “down.” Moving the gear cases away from the boat transom is called trimming “out” or “up.” In most cases, the boat will perform best with the outboards adjusted so the hull will run at a three to five degree angle to the water.

The term “trim” generally refers to the adjustment of the outboards within the first 20 degree range of travel. This is the range used while operating your boat on plane. The term “tilt” refers to adjusting the outboards further up for shallow water operation, trailering or “tilting” the outboards out of the water. Refer to the engine owner’s manual for information on the proper use and maintenance of the power tilt and trim.

⚠ CAUTION

The outboard hoses and cables or the transom gel coat can be damaged if the engine(s) are tilted to full up position or turned in the wrong direction. Turn the steering wheel completely to one direction or the other before tilting up to determined which direction is best for your boat.

2.5 Engine Stop Switch

Your Pursuit is equipped with an engine stop switch and lanyard. When the lanyard is pulled away, it will shut off the engine.

⚠ WARNING**LOSS OF CONTROL AND UNSAFE BOAT HAZARD**

An engine stop switch system that does not function properly or is not used can cause death or serious injury. **DO NOT** operate the boat if the emergency stop switch system does not function properly.

Attach the engine stop switch lanyard to a strong piece of clothing on the operator. The engines will not start if the clip is not inserted into the stop switch. Make sure the lanyard is properly attached to the engine stop switch before attempting to start the engine.

DO NOT use the switch to stop the boat under normal operation. Test the switch periodically, if the switch is not operating properly, **DO NOT** use the boat. Contact your Pursuit Dealer and have it repaired.

Refer to the engine owner's manual for more information on the engine stop switch.



Engine Stop Switch

2.6 Steering System

The steering system is hydraulic and made of two main components: the helm assembly and the hydraulic cylinder. The helm unit acts as both a fluid reservoir and pump. Turning of the helm, or steering wheel, pumps the fluid in the hydraulic hoses and activates the hydraulic cylinder causing the motors to turn. A slight clicking sound may be heard as the wheel is turned. This sound is the opening and closing of valves in the helm unit and is normal. Refer to the steering manufacturer owner's manual for specific information on the steering system.

Tilt Helm

A tilt helm, steering wheel may be installed on your boat. To tilt the helm, depress the lever located in the base of the helm and lock into position. DO NOT adjust when the boat is underway.

2.7 Trim Tabs

The trim tabs are recessed into the hull on the transom. Switches are used to control the trim tabs. The switches are labeled to indicate the reaction of the bow of the boat. They control starboard and port up and down movements. Bow up and bow down will control the hull planning attitude, while

port and starboard up and down provide control for the hull trim side to side.

Before leaving the dock, make sure that the tabs are in the full "UP" position by holding the control in the bow "UP" position for ten seconds. Do not continue to operate the switch when the tabs are fully up or down.

Establish the intended heading and cruise speed before attempting to adjust the hull attitude with the trim tabs. Always make slight adjustments to reduce over adjustments. After stabilizing speed and direction, move the trim tabs to achieve a level side to side running attitude being careful not to over trim.

After depressing a trim tab switch, always wait a few seconds for the change in the trim plane to take effect.

Avoid depressing the switch while awaiting the trim plane reaction. By the time the effect is noticeable the trim tab plane will have moved too far and the boat will be in an overcompensated position.

When running at a speed that will result in the boat falling off plane, lowering the tabs slightly, bow down, will improve the running angle and operating efficiency. Too much bow down tabs can reduce operating efficiency and cause difficult steering and handling.

When running at high speeds, make sure the tabs are in the full "UP" position. Only enough trim plane action should be used to compensate for any listing. Trim tabs are more sensitive at higher speeds. Adjust for this and be prepared to slow down if difficulties arise.

Be extremely careful when operating in a following sea. The effect of trim tabs is amplified under these conditions. Difficulty in steering and handling can result from improper trim tab usage, especially in a following sea; raise the tabs to the full bow "UP" position.

When running into a chop, a slight bow down attitude will improve the ride. Be careful not to over trim, difficulty in handling can result.

Trim Tab Indicator

The switches are labeled to indicate the reaction of the bow of the boat when the trim is adjusted, the L.E.D. displays indicate the position of the trim tabs. When adjusting the starboard bow UP or DOWN, the L.E.D. indicator on the PORT (right) side of the panel will illuminate indicating the movement of the PORT tab.

Refer to the trim tab operation manual.



Trim Tab Switches

2.8 Compass

The compass is located at the helm. To adjust the compass, read the instructions on "Compass Compensation" included in the literature packet. The compass cannot be adjusted accurately at the factory as it must be compensated for the influence of the electrical equipment and electronics unique to your boat. The compass should be adjusted by a professional after the electronics and additional electrical accessories are installed and before operating the boat.

DO NOT allow any iron or steel objects to be placed in its vicinity - even temporarily. Refer to the owner manual included in the Skipper Kit for detailed information.

2.9 Control Systems Maintenance

Control Maintenance

Periodic inspection of the control systems and all connections should be made. Signs of rust, corrosion, wear, or other deterioration must immediately be serviced. Periodic lubrication of all moving parts and connections with light waterproof grease is required.

Control system adjustments may become necessary. If adjustments are necessary, see your Pursuit Dealer.

Steering System Maintenance

Periodically inspect all steering hoses, linkages and helm assemblies. Signs of corrosion, cracking, loosening of fastenings, excessive wear, or deterioration must be corrected immediately. Check the hydraulic steering fluid level frequently and maintain the proper level. Periodic lubrication of all moving parts and connections with light waterproof grease is required. Failure to do so can lead to steering system failure and result in loss of control.

When new, or after repairs, hydraulic steering systems may need to be purged of air. Refer to the information provided with the steering system for specifications and service information. Check steering operation and visually inspect for loose or missing hardware before operating the boat. If you suspect the steering system is damaged, see your Pursuit dealer. DO NOT operate the boat if you suspect the steering system is malfunctioning.

WARNING

LOSS OF CONTROL AND UNSAFE BOAT HAZARD

Improper maintenance of steering system is hazardous and can cause death or serious injury from sudden loss of control. Make sure all steering hardware, cables and fluid levels are regularly inspected and maintained.

DO NOT attempt to service any part of the steering system unless you are familiar or qualified to do so. Follow all instructions regarding maintenance procedures in the steering system owner's manual.

Trim Tab Maintenance

Marine growth can affect the operation of the trim tab planes and actuators. To help reduce marine growth, return the trim tabs to the full "UP" position after operating the boat. Inspect and clean the actuators and planes regularly.

The trim tabs also include a zinc anode to help prevent galvanic corrosion. Galvanic corrosion occurs when different metals are submerged in an electrolyte. Sea water is an electrolyte and submerged metal components must be protected. Anodes were factory installed and need to be replaced when they are 75% of their original size.

Refer to Routine Maintenance for information regarding zinc anodes and the trim tab owner's manual for additional maintenance information, fluid specifications and operating instructions.

Fuel Systems

3.1 General

The fuel system of your Pursuit boat is designed to meet the requirements of the U.S. Coast Guard, National Marine Manufacturers Association (NMMA), and American Boat and Yacht Council (ABYC) in effect at the time of manufacture.

The fuel system was factory inspected and pressure tested in accordance with regulations in effect at the time of manufacture. It is the responsibility of the boat owner to maintain the safe condition of the system.

Inspect the system frequently to ensure no deterioration or loosening of connections has occurred.

⚠ DANGER

FIRE/EXPLOSION HAZARD

Fuel and their vapors are highly explosive when exposed to open flame or spark, resulting in death or serious injury.

- **Make sure no vapors are present before turning on electrical equipment or starting engines.**
- **Make sure fuel is added to the fuel tank only. DO NOT confuse other deck fills with fuel fills.**
- **DO NOT remove anti-siphon valves from the system.**
- **Turn off all electrical switches before servicing the fuel system.**
- **DO NOT drain any fuel in the bilge.**
- **Check all fuel lines and fittings for leaks before and after starting the engines and after any fuel system service.**
- **Prime fuel system and check all fittings for leaks before and after starting the engines.**
- **DO NOT block fuel vents.**
- **DO NOT store fuel in any containers or compartments not designated for fuel storage.**

⚠ NOTICE

Certain bulkhead areas are sealed following U.S. Coast Guard regulations at the date of manufacture. Any modifications must be in accordance with the regulations.

3.2 Fuel System



Fuel Valve

The fuel system on your Pursuit boat has one fuel tank and is equipped with a manual “ON/OFF” fuel valve. Refer to the Schematics section. The fuel valve and tank fitting are accessed through deck plates under the mechanical space hatch. The valve is off when the handle is perpendicular to the fuel flow.

The fuel delivery line is equipped with an anti-siphon valve located where the line attaches to the fuel tank. This valve helps prevent gasoline from siphoning out of the fuel tank should a line rupture.

All boats equipped with gasoline engines are required to have anti-siphon valves by the U.S. Coast Guard. DO NOT remove anti-siphon valves from system. Anti-siphon valves prevent fuel from flowing into bilge should a fuel hose or fitting leak. If the valve becomes clogged, clean and reinstall or replace it.

Fuel Tanks

The fuel pick-up tubes are positioned in the tanks to achieve optimum fuel usage, fuel line routing, etc. At certain speeds and hull trim angles, the fuel supply at the withdrawal tube can increase or decrease accordingly. Be extremely careful when attempting to operate the boat when low on fuel. Though some fuel may be in the tank, the trim angle of the boat may cause the fuel to flow away from the pickup tubes.

Fuel Gauge Senders

The fuel gauge senders are more accurate when the boat is stationary and level. Because of the change in attitude when the boat is underway, variations in gauge readings can occur. This system is a relative indication of the available fuel supply and not a calibrated instrument.

Fuel Fills

A fuel fill deck plate is located on the gunwale and is marked "GAS." The fuel fill is opened by turning it counterclockwise with a special key. After fueling, install the fuel cap and tighten with the key; DO NOT over tighten. Use only the fuel recommended by the outboard manufacturer; refer to the engine owner's manual for additional information.

If fuel is added to any other tank, DO NOT attempt to pump fuel out; these systems are not designed to pump fuel. Fuel must be removed by qualified personal only. Fuel in other systems will also require replacement of that system and/or many components.



Fuel Fill

Fuel Vent

There is a vent for the fuel tank on the hull side. While the tank is being filled, air displaced by the fuel will escape from the vent. Do not allow fuel to be expelled from the vent and pollute our environment. Fill the fuel tank slowly and monitor the fuel gauge while filling. Spilled fuel can be dangerous.

Wash the areas around the fuel fill plates and below the fuel vent to help reduce discoloration of fiberglass or striping.

Fuel Filters



Fuel Filter

The fuel filter is located in the transom area of the boat. The filter is the water separator type. Check the filter for water frequently to ensure an adequate supply of clean, dry fuel to the engine. The filter element should be changed once a season. The fuel primer bulb is connected the top of the fuel filter.

Turn off all electrical switches before servicing the fuel system and DO NOT drain any fuel into the bilge. Check all fuel lines and fittings for leaks before and after starting the engines and after any fuel system service. Prime fuel system and check all fittings for leaks before starting the engines.

3.3 Fueling Instructions

⚠ DANGER

FIRE/EXPLOSION HAZARD

Gasoline vapors are highly explosive when exposed to open flame or spark, resulting in death or serious injury.

- Stop engines before fueling.
- DO NOT smoke or allow open flames or sparks nearby, within 50 ft (15 m) of the fueling area.
- Maintain contact between fuel nozzle and fuel tank fill to prevent electrostatic spark. DO NOT use a plastic funnel.
- Fill in an open area.

BURN HAZARD

Fuel floating on water which is ignited can cause death or serious injury. Fuel will float on top of water and can burn. If the boat is abandoned, swim upwind, far enough to avoid fuel that can spread over the surface of the water.

Try not to spill fuel. If fuel is spilled, wipe up all traces with dry rags and immediately dispose of the rags properly onshore. DO NOT allow fuel to stay on the finish of the boat, discolor and damage to trim can occur. Avoid fueling at night, except under well-lighted conditions. Also, monitor fuel level gauge to avoid overfilling.

CAUTION

Use only the fuel recommended by the engine manufacturer. Use of old, contaminated fuel can cause the engine to malfunction or severe damage. Do not use fuel that contains more than 10% ethanol, harsh additives or methanol; damage to the engines and fuel system will result. Fuel system damage, related to use of alcohol-blended fuels, is not covered by the Pursuit Limited Warranty. Refer to the engine owner's manual for specific fuel requirements for your engines.

To fill fuel:

- Turn all switches to "OFF."
- Secure boat.
- Remove passengers from boat.
- Extinguish all flame producing items.
- Open fuel fills with fuel fill key, counterclockwise.
- Put nozzle in the fuel fill opening.
- Fill the fuel tanks slightly less than rated capacity to allow for expansion.
- Remove the nozzle.
- Install and tighten fuel cap. Do not to overtighten.

Check the fuel compartment and below the deck for fuel odors. If you smell fuel, DO NOT start engines.

DANGER

FIRE / EXPLOSION HAZARD

Fuels are extremely flammable and highly explosive under certain conditions. DO NOT smoke or allow open flames or sparks nearby when inspecting the fuel system.

Frequently check fuel lines and all system components (filters, primer bulbs, clamps and connections) for leaks, damage or deterioration, or if you suspect damage, replace as necessary. Surface cracking on a hose indicates wear. Replace it.

Spray the valves, fuel tank gauge sender and ground connections with a metal protector.

Inspect the fuel fill cap o-ring seals frequently and lubricate with petroleum jelly or silicone grease. The o-ring seal prevents water from entering the fuel system through the fuel fill cap. If the o-ring is damaged, or you suspect it is damaged, replace it.

Old, degraded gasoline can affect engine performance and damage the engine and boat fuel system. Chemical changes occur as gasoline ages, reducing octane and can cause deposits and varnish in the fuel system.

If your boat is not operated enough to require at least one full tank of fresh fuel a month, a fuel stabilizer should be added to the gasoline to protect the fuel from degrading. Do not allow the boat to sit unused for an extended period with the fuel tanks less than 3/4 full. Changes in temperature and weather conditions can cause condensation in fuel tanks. Your Pursuit dealer or the engine manufacturer can provide additional information on fuel degrading and fuel stabilizers recommended for your engine.

Improper storage of fuel at marinas, limited boat usage, etc. can cause the fuel to become contaminated. Periodically, it may be necessary to pump accumulating water and contaminated fuel from the bottom of the fuel tanks. If the fuel system on your boat becomes contaminated, contact your dealer or marina for assistance.

Avoid using fuels with alcohol additives. Alcohol blend gasoline will absorb moisture from the air which can reach such concentrations that "phase separation" can occur where the water and alcohol mixture becomes heavy enough to settle out of the gasoline to the bottom of the tank. Since the fuel pickup tubes are near the bottom of the tank, phase separation can cause the engine to run very poorly or not at all. Phase separation is more severe with methyl alcohol and will increase as the alcohol content increases. Water or a jelly like substance in the fuel filters is an indication of phase separation from the use of alcohol blended fuels.

Diesel engine operation requires a good supply of clean, water-free diesel fuel. Algae can grow in the accumulated water in the diesel fuel tank. This will normally occur in warm climates. Adding a high quality diesel fuel additive containing an algaecide periodically may be required to control algae in your diesel system, depending on your boating area. Contact your Pursuit Dealer or engine manufacturer for additional information regarding fuels and additives.

Electrical Systems

4.1 General

Your Pursuit boat is equipped with a 12 volt DC electrical system. The DC system draws current from onboard batteries.

Electrical schematics are included in this manual to assist technicians in the servicing the electrical systems. Pursuit recommends you take your boat to an authorized Pursuit dealer for service or installation of additional electrical equipment. Pursuit reserves the right to modify or update the electrical system at any time without notice to the consumer or obligation to make updates to boats built prior to the change.

Some compartments on your boat may be lighted. Lights bulbs produce heat and can ignite combustible products. Turn off all lighting before you leave the boat.

WARNING

FIRE OR EXPLOSION HAZARD
Ignited combustible products can cause fire or explosion, resulting in death or serious injury. **DO NOT** store combustibles near lights and turn off all lighting before leaving the boat.

4.2 DC System

Batteries

The 12-volt batteries have been selected to provide optimum performance for engine starting, and house and electronics loads. There are two, group 31, lead acid batteries. These batteries require similar maintenance to automobile batteries. The batteries are located in the aft bilge. A circuit breaker on the engine protects the engine ignition systems and gauges. Refer to the engine owner's manual for information on the circuit breakers installed on your engines.

DC Distribution

The 12-volt DC system is made up of batteries that are charged by the engine charging system. Boats that are factory rigged with Yamaha® engines utilize the Yamaha Battery Isolator to charge the engine battery and the house battery. 12-volt power is distributed to the battery switches, accessed through a hatch in the aft port corner of the cockpit, and main breakers, in the battery switch panel, that protect the helm panel, electronics, 24-hour essential circuits and the windlass.

The circuit breaker on the engine protects the engine ignition systems and gauges. Refer to the engine owner's manual for information on your engines.

CAUTION

Proper fuse or breaker protection must be provided for all 12-volt equipment added. DO NOT overload the Accessory Circuit Breakers or other circuitry through additional 12-volt equipment.

Battery Switches

There are two battery switches and one parallel switch to manage the 12-volt power distribution. The **1** ("number" 1), battery switch controls the battery for the engine and is reserved for engine starting. The **2** ("number" 2), battery switch provides power to the DC main and electronics main circuits.



Battery Switches and Main Breakers

The **EMERG PARALLEL** (battery parallel) switch connects the both batteries for emergency starting in the event one of the batteries is low or dead. As long as the **EMERG PARALLEL** switch remains in the "OFF" position, the engine battery will not be discharged by the use of 12-volt accessories and equipment on the boat.

Make sure the **1** and **2** battery switches are activated whenever the engine is running to ensure that all 12-volt accessories will operate when they are needed.

CAUTION

DO NOT operate the boat with the **EMERG PARALLEL** battery switch in the ON (combined) batteries position.

Breakers

The main breakers are located in the battery switch panel and provide protection for all DC power. To reset the breaker: turn OFF the component for the breaker, turn the Breaker to the OFF position and then back to ON.

DC Main

Supplies the 12-volt current to helm panel.

Electronics Main

This is reserved for electronic accessories installation. An electronic bus is located behind the helm.

24 Hour Essential Circuits Module

Current is supplied to the automatic float switches for the bilge pumps and stereo memory when the batteries are connected and the battery switches are OFF.

Spare - Reserved for a spare accessory. Any accessory device added must not exceed the amperage of the breaker or total circuit capacity.

Elect - Not used.

Stereo Memory - This breaker powers the stereo to maintain station memories and settings.

Aft Bilge - This breaker powers the aft bilge pump.

4.3 Helm Switch Panel

The helm panel contains switches and circuit breakers. The circuit breakers are the “plunger” type; push to reset. Breakers are normally in the ON position. Should any of the breakers trip, reset by pressing the plunger. The following are descriptions of the components controlled by the helm switches:



Helm Switch Panel

Horn

Press to activate the horn.

Nav/Anc

Press the top of the rocker switch to activate the navigation lights. Press the bottom of the rocker switch to activate the anchor light.

Aft Bilge

Press to activate the manual pump. If the automatic pump activates, the automatic

bilge pump indicator on the switch will illuminate.

Livewell

Press to activate the livewell circulation pump to supply water to the livewell. The pump is protected by a circuit breaker on the helm panel and an automatic reset breaker in the pump motor.

Fishbox Macerator

Press to activate the fishbox macerator. The fishbox macerator switch is momentary to activate the overboard macerator discharge system for the fishbox.

Cockpit

Press to activate the lights that illuminate the cockpit area.

Spreader

Activates the floodlight located on the optional T-top. These lights provide additional lighting for the rear of the cockpit.

Hardtop

Press to activate the floodlights located under the optional T-top.

Fresh Water (Optional)

Press to activate the fresh water pump. The pump is a pressure-on-demand type and is protected by a circuit breaker and an automatic re-set at the breaker on the pump.

Washdown

Press to activate the raw water washdown pump. The pump is a pressure on-demand type and is protected by a circuit breaker on an automatic reset breaker in the pump motor.

Refer to the Plumbing Systems Chapter for more information on the livewell and washdown systems.

ACC

This is an open switch and reserved for future additional accessories. DO NOT exceed 10 amps.

4.4 Electrical System Maintenance

DANGER

Contact with an energized AC or DC can cause death or serious injury. DO NOT inspect or service an energized electrical system. Disconnect the AC and DC electrical system power source.

12-Volt DC Electrical System Maintenance

Semi-annually spray all exposed electrical components behind the helm and in the plugs with a protector specific for electrical connections. Exterior light fixture bulbs should be removed and the metal contact areas coated with a non-water soluble lubricant like petroleum jelly or silicone grease. The sockets should be sprayed with a protector. DO NOT get any oil or petroleum jelly on the glass portion of the bulbs, this will cause the bulb to overheat and burn out.

CAUTION

Use exact replacement light bulb; a different bulb can cause fixture to overheat, melt or short circuit.

Make sure to check that all below deck wiring is properly supported, the insulation is sound and there are no loose or corroded terminals. Clean any corroded terminals thoroughly with sandpaper, or replace them. Tighten securely and spray with a metal and electrical protector. Inspect all engine wiring.

Check the electrolyte level in the batteries regularly and add distilled water as necessary. If the batteries are frequently charged by a battery charger, check the electrolyte level more often. The correct fluid level in the cells is approximately ¼ to ½ inch above the plates. If fluid is needed, fill to the proper level with distilled water ONLY. DO NOT overfill. Some batteries are sealed and cannot be filled.

Keep the tops of any battery clean and dry. Dirt and water can conduct electricity from one post to the other and can cause battery discharge or cause errant engine warnings.

Keep the battery posts free of corrosion. DO NOT use wing nuts to attach battery cables. Remove the cables and clean the posts and cable clamps with a battery post cleaner or sandpaper as required. Coating the battery posts and cable clamps with petroleum jelly or silicone grease will help protect and reduce corrosion. Battery cables, both positive and ground must be replaced when they show signs of corrosion or fraying. Deteriorated cables cause a considerable voltage loss when high currents are drawn, as for starting the engine.

DANGER

FIRE OR EXPLOSION HAZARD
Explosion or fire from hydrogen gases produced by lead acid batteries will cause death or serious injury. DO NOT smoke or bring a flame near battery storage area. If ignited by a spark or flame, gas may explode violently, causing spraying of battery acid or fragmentation of the battery.

Plumbing System

5.1 Fresh Water System

General

The fresh water system consists of a potable water tank, distribution lines and a distribution pump. The pump is equipped with an automatic pressure switch and is located in the forward storage compartment. An in-line strainer located near the pump protects the system from debris. The tank is filled through a labeled deck fill located on the starboard side of the swim platform.

DO NOT confuse other deck fill with fresh water fill. If toxic fluids or fuel is added to fresh water tank, the system will be contaminated. DO NOT attempt to pump fuel out; this system is not designed to pump fuel. Fuel must be removed by qualified personnel only. Fuel in the fresh water systems will also require replacement of that system and/or many components.

⚠ DANGER

FIRE OR EXPLOSION HAZARD
Fuel and their vapors are highly explosive when exposed to open flame or spark, resulting in death or serious injury. Do not confuse deck fills.

Operation

Fill the water supply tank slowly through the FRESH WATER FILL deck plate. After filling tank, partially open all faucets. Turn on "Fresh Water System" switch at the helm. Allow the pump to run until all of the air is purged from the system and a steady stream of water is flowing from each outlet. Next, turn off the faucets one by one. As the pressure builds, the pump will automatically shut off.

When properly primed and activated, the water system will operate like the water system in a home. An automatic pressure sensor keeps the system pressurized. If the system has been recently filled or has not been used for an extended period, air may accumulate at the pump and the system may have to be re-primed. Whenever the boat is left unattended, turn the fresh water system switch "OFF."

⚠ CAUTION

DO NOT allow the fresh water pump to run dry; damage to the pump can occur. The fresh water pump works on demand and WILL NOT shut off when the tank is empty. Turn the water pump switch "OFF" when the system is not in use. Operating any pump from a low-charged battery can lead to a pump failure. Keep the batteries properly charged. The fresh water system must be properly winterized prior to winter lay-up. Refer to Winterizing.

5.2 Raw Water Washdown

The raw water washdown system pump is supplied by hoses connected to a ball valve and a thru-hull fitting located in the bilge, accessed under the aft seat.

Operation

Make sure the ball valve is open before attempting to operate the raw water washdown system. The pump is activated by the washdown switch located on the helm. When activated, the pressure switch will automatically control the pump. As pressure builds in the washdown hose, the pump will shut off. When the washdown hose is in use and the pressure drops, the pump will turn on. Turn the switch off when the washdown is not in use. The raw water washdown is equipped with a sea strainer on the intake side of the pump, located in the aft bilge; check it frequently and clean as necessary.



Washdown Hose Connector (Typical)

Priming the System

Open the ball valve and hose connector, and activate the pressure pump. Run the pump until all air is purged from the system. Close the thru-hull ball valve before the boat is hauled from the water to eliminate an air lock in the system. It may be necessary to re-prime the raw water system if the system is not used for an extended period.

5.3 Livewell

Seawater is provided to the livewell by a 12-volt circulating pump. This pump is designed to carry a constant flow of water to the livewell. The pump is activated by the livewell switch on the helm. An overflow built into the livewell automatically controls livewell water level. Always turn livewell pump off at the switch panel when not in use.

To fill the livewell, insert the plug into the drain fitting at the bottom of the livewell. Make sure the ball valve at the intake thru-hull fitting is open and turn on livewell pump. When water level reaches the overflow, it will begin to circulate.

To drain, turn off pump and remove plug. When the livewell has drained, use the washdown hose to flush livewell and drain debris.

Close the livewell thru-hull ball valve whenever livewell is not in use to prevent water from entering the livewell while the boat is cruising. The livewell pump is equipped with a sea strainer on the intake side of the pump located in the aft bilge. Check it frequently and clean as necessary.

Do not use livewell for stowage. Seawater can enter livewell when it is not in use and damage stowed equipment.

5.4 Drainage

General

Some drain thru-hull fittings are equipped with ball valves that are always open under normal operating conditions. In the event of an emergency, close the valves to prevent sea water from entering the boat through the drainage system. Check and operate the drain valves at least once a month to make sure they are in good condition and operating properly. Also, check the drain system to ensure it is free flowing and hoses on the thru-hull fittings are secure and not leaking.

Review and become familiar with the drainage schematic and location of the thru-hull drain valves.

A situation requiring one or more drain valves to be closed can be dangerous to boat and all onboard. If this occurs, distribute PFD's and take all necessary safety precautions, including notifying the Coast Guard or local agency, until the problem is determined and corrected.

Bilge Drainage

The bilge pump is located in the aft bilge. The bilge pump pumps water out of thru-hulls located above the waterline in the hull. See Electrical Systems for additional information on bilge pump operation.



Automatic Bilge Pump Switch

Inspect the bilge area frequently for evidence of excessive water. Continuous operation of the bilge pump can mean there is excess water in the bilge. Test the bilge pump at regular intervals. Debris can also prevent the pump from operating or make it operate continuously. Make sure no debris is blocking the bilge pump float.

Bilge pumps and bilge pumping systems are not designed for damage control.

Continuous operation of the bilge can mean a leak or a drain plug is installed incorrectly; make sure all drain plugs are installed.

Excess water in the bilge area will adversely affect the handling and maneuverability of the boat and can cause personal injury. DO NOT allow the bilge pump to operate after all the water has been cleared from the bilge area. Damage to the pump will occur.

The bilge pump system consists of a pump and automatic float switch. The float switch activates the pump whenever the bilge water level rises.

Current is supplied to the automatic float switches whenever the batteries are connected. The bilge pump switch at the helm is supplied current when the 2 ("number" 2), battery switch is in the "ON" position. The breaker for the manual switch located in a switch panel in the cockpit.

Activate the manual bilge pump briefly each time the boat is used to ensure pumps are operating properly. Activate the automatic switch manually to verify operation by placing a wet rag across the sensor and mounting bracket. There is a delay built into the switch before the pump will activate. The pump will continue to operate for a short time after the rag is removed. Refer to the Water Witch manufacturer's information under "Plumbing" for more information.

When the boat is out of the water, the bilge can be drained by a thru-hull drain located in the transom, near the bottom of the hull. It is important to check the drain plug regularly to make sure it is tight.

A loose drain plug will allow sea water to enter the bilge and cause the boat to sink.

Check the drain plug frequently to make sure it is secure.

Any oil spilled in the bilge must be thoroughly removed and properly disposed of before operating the bilge pump. The discharge of oil from the bilge is illegal and subject to fine.

⚠ NOTICE

The federal water pollution control act prohibits the discharge of oil or oily waste into or upon the navigable waters of the United States or the waters of the contiguous zone if such discharge causes a film or sheen upon, or a discoloration of the surface of the water, or causes a sludge or emulsion beneath the surface of the water. Violators are subject to a penalty of \$10,000.

Exterior Drains

Your Pursuit has two scupper drains located in the rear of the cockpit. The drain rails for the compartments drain overboard by gravity.

The fishbox is equipped with a macerator pump and drain plug. Removing the drain plug in the fishbox will allow the fishbox to be pumped overboard. The macerator is activated by a momentary switch located in the helm panel.

Allowing the macerator pump to run after the fishbox is empty may cause damage to the pump. Flush out and clean the fishboxes after use.



Drain Adapter



Clamp Open



Clamp Closed

The fishbox is equipped with a Banjo[®] fitting to allow the drain hose to be disconnected from the fishbox drain. Lift the fishbox up and slide it to the port side of the opening to gain access to the Banjo[®] fitting. Pull both levers of the Banjo[®] fitting outward to disconnect the hose. The fishbox can now be removed. To reinstall, push the hose fitting onto the drain adapter and pull both levers down.

The forward compartments drains by gravity through a seacock which is accessed through the aft hatch in the head compartment. The seacock should normally be in the open position and closed only in the case of an emergency.)

The cooler located in front of the console, drains by gravity onto the cockpit sole.

The rope locker drains overboard through a drain fitting located in the hull side at the bottom of the rope locker. It is important to inspect the drain frequently to remove any accumulated debris.

Interior Drains

A drain plug in the head compartment sole is provided to drain water that may accumulate on the head floor. This plug also keeps the aft bilge isolated from the head compartment. Remove this plug to drain water from the head sole only and reinstall.

5.5 Plumbing System Maintenance

Information supplied with water system components, by the equipment manufacturers, is included with this manual. Refer to the information for additional operation and service information.

Fresh Water System

CAUTION

Turn the fresh water system switch "OFF" when leaving the boat unattended or when the fresh water system is not in use.

Perform these routine maintenance procedures to maintain your fresh water system:

- Remove filter screens from faucet spouts and eliminate any accumulation of debris. A debris build-up can cause the pump to cycle excessively.
- Check and clean the fresh water system strainer located on the intake line near the pump at least annually.
- Spray pumps and thru-hull valves with a protective oil periodically.
- Remove the lid on the shower sump assembly located under the mid-berth, clean debris from the sump and flush with clean water, activate the float switch to test the pump and spray the pumps and metal components with a metal protector periodically.
- Add a commercially available potable water conditioner to the water tank to keep it fresh.
- Make sure the fresh water system switch is "OFF" when leaving the boat unattended or when not in use.

Raw Water System

CAUTION

If a hose ruptures, turn pump off immediately. Close the thru-hull valve before performing maintenance on sea water pump. Operating any pump from a low-charged battery can lead to a pump failure. Keep the batteries properly charged. The raw water system must be properly winterized prior to winter lay-up. Refer to Winterizing.

Perform these routine maintenance procedures to maintain your raw water system:

- Check hoses for signs of deterioration, especially the sea water hoses.
- Remove and clean livewell and wash-down pump sea water strainers, as needed. Spray pumps and thru-hull valves with a metal protector periodically.
- Drain and clean the fishboxes and livewells after each use.
- Operate all thru-hull valves at least once a month to keep them operating properly. If a hose ruptures or leaks, turn off pump immediately. Keep the thru-hull valve closed when performing service on a sea water system.

⚠ CAUTION

Maintain a proper charge on the batteries; operating the pressure pump from a battery with a low charge could lead to pump failure.

The fresh and raw water systems must be winterized properly before storage. Refer to Winterizing.

Drainage Systems

Perform these routine maintenance procedures to maintain your drainage system:

- Clean the cockpit drain rails with a hose and water to remove all debris.
- Clean the hardtop leg drain holes, especially before winter storage.
- Clean the bilge pump and automatic float switch strainers of any debris. Check the bilge for debris that can block the function of automatic switch.
- Test rear automatic bilge pump switch each time the boat is used, for proper operation. Operate the knob or lever on the side of the switch until the pump is activated, or add water to the bilge until the water level is high enough to activate the pump.
- Flush all gravity drains with fresh water to keep them clean and free flowing.
- Clean and inspect the shower and sink drain sump system. Remove accumulated debris and flush with fresh water. Test the automatic sump pump switch for proper operation, frequently.
- Clean and flush the fishbox and cooler/storage boxes with a mild soap or a bilge cleaner and fresh water after each use to keep them clean and fresh.
- Operate the thru-hull valves once a month and service as required.
- Check the drain system regularly to ensure it is free flowing and hoses on the thru-hull fittings are secure and not leaking.

⚠ CAUTION

DO NOT use harsh chemical drain cleaners in drain systems; permanent damage to the hoses, fittings and system can result. Also, drains and pumps must be properly winterized before winter lay-up.

Ventilation System

6.1 Carbon Monoxide and Proper Ventilation

Read "Carbon Monoxide" in the Safety Section. It contains important information on carbon monoxide and the carbon monoxide detector.

6.2 Bilge Compartment

Ventilation

Air flow into the bilge compartment is supplied by four vents on either side of the cockpit, under the gunwale boards.

6.3 Head Compartment Ventilation

The head compartment ventilated is provided through a screened ventilation opening on the head compartment door.

6.4 Maintenance

- Periodically lubricate all hinges and latch assemblies with a light oil. Clean up any excess oil.
- Periodically clean and coat gasket materials with silicone to help keep them clean and pliable.

Exterior Equipment

7.1 Deck

CAUTION

Unsecured open exterior doors and/or hatches can slam closed and cause injury or damage the boat. Most doors and hatches are equipped with fasteners, hatch lifters, snaps and/or straps to secure them open make sure they are properly secured while they are open.

Rails and Deck Hardware

Rails and deck hardware perform specific functions. Do not use for securing fenders or mooring lines; these must be secured to the cleats. Make sure mooring lines are clear of rails or stanchion, or damage can result.

Some cleats are flush mount and must be raised prior to use.

DO NOT use cleats or any other hardware for the purpose of towing or being towed. Inspect all hardware periodically for loosening, wear or damage. Repair or replace immediately.

Anchor/Rope Locker

The anchor locker at the bow of the boat can be accessed through the deck hatch. The anchor locker is drained by a thru-hull fitting in the hull side near the bottom of the locker. Check it frequently and keep it clean and free flowing.

Downriggers (Dealer Installed)

Downriggers must be installed on the deck area aft of the gunwale board. Your boat is reinforced in this area for the installation of downriggers. DO NOT install or insert downriggers in the rod holders mounted in the gunwale boards; damage can occur.

7.2 Cockpit

Swim Platform

Your Pursuit boat is equipped with an integral swim platform. Inspection deck plates are located in the splashwell to provide access to the stern bilge and engine mounting bolts. A deck plate on the port side of the platform provides access to the ball valve for the port cockpit scupper. A deck plate under the boarding ladder provides access to the ball valve for the starboard cockpit scupper. Make sure these deck plates are secure before operating your boat.

A foldaway boarding ladder is located under the hatch on the swim platform. DO NOT use swim platform or ladder while an engine is running. The engines must be "OFF" before allowing anyone to enter or exit the boat or when they are in the water. Stow ladder before starting an engine.

DANGER

CARBON MONOXIDE POISONING AND/OR ROTATING PARTS HAZARD

Poisonous CO gases are present at the rear of the boat when an engine is running. A rotating propeller can cut or entangle swimmers. Both of these hazards will cause death or serious injury. DO NOT use the swim/boarding platform when the engine is running.

Transom Door

Do not use the transom door when the boat is in motion. DO NOT leave the transom door unlatched. Latch it in the full "OPEN" or full "CLOSED" position.

⚠ WARNING

UNSAFE BOAT HAZARD

Failure to close and secure transom door/gate while underway can expose passengers to rotating propellers, throw them overboard or swamp the boat which can cause death or serious injury. Close and secure door/gate before getting underway.

⚠ CAUTION

Inspect transom door/gate fittings periodically for wear, damage or loose fit. Repair or replace before using your boat.

Stern Bench Seat

The stern bench seat is hinged and opens to allow access to the fishbox. Removing the fishbox provides access to the stern bilge, the bilge pump and other equipment installed there. Make sure the seat latched before getting underway.

⚠ WARNING

UNSAFE BOAT HAZARD

Failure to close and latch the stern bench seat while underway can expose passengers to rotating propellers, throw them overboard or swamp the boat which can cause death or serious injury. Close and latch the seat before getting underway.

⚠ CAUTION

Keep hands away from the seat mechanism when opening and closing.

To open the Stern Bench Seat

Tilt the engines to the full down position, release the latches at the front of the seat and open the transom door. The seat can now be opened.

⚠ NOTICE

Damage to the engine cowlings, stern seat and transom door can occur if the stern seat is not opened properly.

Removing the Stern Bench Seat

The batteries are located below the stern bench seat and fishbox. If the batteries are discharged and the engines are tilted in the full "UP" position, the bench seat cannot be opened and must be removed to provide access to the batteries. Remove the bench seat by releasing the latches at the front of the seat, opening the transom door and removing the pins in the hinges at the rear of the seat.



Stern Seat Hinge

Two people will be required to tilt the seat forward and lift it off the fishbox. The gas hatch lifter will still be attached to the seat. Make sure the weight of the seat does not bend the gas hatch lifter. Have one person hold the starboard end of the seat that is attached to the hatch gas hatch lifter and lower the other end of the seat to the cockpit floor. While one person continues to hold the starboard end of the seat to keep it from bending the hatch lifter, the other person can use a small screw driver or a knife to remove the plastic end cap from the hatch lifter ball hinge fitting on the seat. Make sure the hatch lifter is fully extended and pull the lifter off the ball hinge on the seat. Leave the other end of the hatch lifter attached to the seat landing and lay it in the trough next to the fishbox.

The seat is now free and can be set in the cockpit.

To Reinstall:

Make sure the engines are at the full down position, the fishbox is installed and the hatch lifter is laying in the trough next to the fishbox. Lift the seat into position on the seat landing in the closed position and install the hinge pins and retaining rings. Open the seat and snap the hatch lifter to the ball hinge fitting on the seat.

Install the plastic end cap in the lifter ball hinge fitting to prevent the lifter from popping off the ball hinge.

Note: If the boat is out of the water with the engines tilted up and the batteries are discharged, the batteries and battery tray area can be accessed by using the manual tilt release valve screw on the engine tilt cylinder and tilting the engines down manually. The seat can then be opened in the normal fashion. Refer to the engine owner's manual for instructions on lowering the engines manually. Never use manual tilt release valve screw when the boat is in the water. Sea water could enter the power tilt system and cause damage to the unit.

Forward Sunpad Cushions (Optional)

The sunpads are secured to the forward hatches with snaps or similar fittings. The cushion must be secured in place prior to getting underway, when trailering or before stepping on or sitting on the sunpad cushions.

When not in use, stow the cushions in the head compartment.

T-TOP (Optional)

The T-top is made of welded anodized aluminum and is designed to accommodate radio or radar antennas and navigation lights. It is equipped with an overhead light, an overhead storage compartment for life jackets and other soft, light items. It could also be equipped with optional outriggers and/or rod holders.

Radar and electronics antennas must be mounted near the center section of the T-top in the area above the legs.

Do not mount any antennas or equipment to the brow area or to the rear of the top. The T-top is not design to support the weight of accessories in these areas.

The T-top warranty will be void if the top is modified in any way or heavy accessories like life rafts or electronics lockers are mounted to the top. Additionally, if items like radar antennas, spotlights and other accessories are mounted in the wrong location, the warranty could be void. If you intend to add equipment or make modifications to the T-top, contact Pursuit Customer Relations to make sure the equipment you would like to add or the intended modification will not void the warranty on the T-top.

If an after market T-top is installed, it must be designed with front legs that are bolted to the console on either side of console seat and the rear legs bolted to the cockpit sole at the rear of the console. There are aluminum plates or wood reinforcement in the laminate in these areas for securing the T-top leg bases. Both front and rear legs should also have brackets that are thru-bolted to the console just below the windshield to provide additional stiffening for the T-top. If you intend to install an after market T-top on your boat, contact your dealer or Pursuit Customer Relations.

Interior Equipment

8.1 Head Compartment

Permanent Toilet

The permanent toilet qualifies as a Marine Sanitation Device (MSD). It is equipped with a deck pump-out and has a self-contained water supply. The system is made up of two major components, an upper tank and a lower tank. The upper tank contains the fresh water supply, a bellows pump, a seat and the lid. The bottom tank contains the flush valve and a waste holding tank.

The toilet is equipped with a permanent deck mounted pump-out system to evacuate the waste. Boats with an MSD will be equipped with a deck fitting marked "Waste" located on the deck. Since this system is required to be permanent, the bottom waste tank cannot be removed and the only way to evacuate the system is by an approved waste dumping station.

To use the toilet, add the recommended amount of holding tank deodorant to the waste tank and fill the water supply. To flush after use, pull the waste valve handle straight out, then press the flushing bellows one or more times to rinse. To close and seal the waste holding tank, simply push the valve handle all the way in. Monitor the level in the waste tank and empty as necessary.

To keep your toilet operating properly it must be emptied and properly cleaned periodically. The toilet should be cleaned and inspected for leaks regularly. Periodically add chemical to the toilet to help control odor and to chemically break down the waste. Refer to the manufacturer owner's manuals for additional operating and maintenance information.

NOTICE

The head and macerator systems must be winterized before winter layup; refer to Winterizing.

8.2 Audio System

Stereo (Optional)

The stereo is located in the head compartment. An iPod®/MP3 USB input jack is included with the stereo and is installed on the helm. An optional satellite radio system made up of a receiver and an antenna installed on the T-top is available. Refer to the stereo owner's manual for additional information.

Safety Equipment

9.1 General

Your boat and outboard engines have been equipped with safety equipment designed to enhance the safe operation of the boat and to meet U.S. Coast Guard safety standards. The Coast Guard or state, county, and municipal law enforcement agencies require certain additional accessory safety equipment on each boat. This equipment varies according to length and type of boat and type of propulsion. Most of the accessory equipment required by the Coast Guard is described in this Section. Some local laws require additional equipment. It is important to obtain "Federal Requirements And Safety Tips for Recreational Boats," published by the Coast Guard, and copies of state and local laws, to make sure you have the required equipment for your boating area. You should also read the book entitled "Sportfish, Cruisers, Yachts - Owner's Manual" included with this manual.

Your Pursuit boat could be equipped with engine alarms and cabin monitoring equipment. These systems are designed to increase your boating safety by alerting you to potentially serious problems in the primary power systems, the engine compartment and the cabin. Alarm systems are not intended to lessen or replace good maintenance and "Pre-Cruise System Check."

This Section also describes safety related equipment that could be installed on your boat. This equipment will vary depending on the type of engines and other options installed by you or your dealer.

9.2 Engine Alarms

Most outboards are equipped with an audible alarm system mounted in the helm area that monitors selected critical engine systems. The alarm will sound if one of these systems begins to fail. Refer to the engine owner's manual for information on the alarms installed with your engines and additional operating and maintenance information.

If the alarms sounds:

- throttle the engines back to idle immediately.
- shift to neutral.
- monitor the engine gauges to determine the cause of the problem.
- if necessary, shut off the engines and investigate until the cause of the problem is found.
- if the boat is equipped with water sensors in the fuel filters, make sure to check them for excessive water.

9.3 Neutral Safety Switch

Every throttle/shift control system has a neutral safety switch. The switch allows the engines to be started in NEUTRAL only. If engines will not start, make sure controls are in NEUTRAL. Control or cable adjustments may be required to correct this condition should it persist. See your Pursuit Dealer for necessary control and cable adjustments. Refer to the Helm Systems for more information on the neutral safety switch.

9.4 Engine Stop Switch

Your Pursuit boat is equipped with an engine stop switch, clip and lanyard. When the lanyard is pulled, it will shut off the engines.

WARNING

LOSS OF CONTROL AND UNSAFE BOAT HAZARD

An engine stop switch system that is not used or does not function correctly can cause death or serious injury. DO NOT operate the boat if the stop switch system does not function properly.

The stop switch will stop an engine whenever the lanyard is pulled far enough to disconnect the clip from the switch. Attach the lanyard to the boat operator whenever an engine is running, but be aware of loss of engine power if the switch is activated.

If the operator is thrown from the seat, or moves too far from the helm, the lanyard will disconnect the clip from the switch, shutting off the engine.

To attach a lanyard, connect the clip to the emergency stop switch and the hook to a strong piece of clothing on the operator, such as a belt loop.

If the engines will not start, the clip may not be inserted into the engine stop switch properly or the control is not in neutral. Make sure the clip is properly attached to the engine stop switch before attempting to start the engine.

Always carry a spare stop switch clip and lanyard and instruct at least one other person onboard the operation of the stop switch and location of the spare.

9.5 Automatic Fire Extinguishing System (with Optional Generator)

WARNING

FIRE/EXPLOSION HAZARD

The gas of the fire extinguisher system displaces oxygen to “smother” the fire. **DO NOT** open the hatch. Oxygen can feed a fire and flashback can occur which can cause death or serious injury. If the onboard fire system discharges, wait at least 15 minutes before opening engine hatch.

The generator is equipped with an automatic fire extinguishing system. The extinguisher has been chosen and located to provide sufficient coverage of the generator compartment. While the system helps ensure bilge fire protection, it does not eliminate the U.S. Coast Guard requirement for hand held fire extinguishers.

The system is equipped with an engine shut-down circuit to automatically shut down the generator. The red light on the fire extinguisher control panel will light and an alarm will sound if this should occur. When suffi-

cient time has elapsed for the fire to be extinguished and a flashback is no longer possible, find and fix the problem, then the override switch on the control panel can be moved to the “OVERRIDE” position and the engines can be restarted. Refer to the Automatic Fire Extinguisher System in the Helm Systems.

If the extinguisher system is activated, shut down all engines immediately. Turn off all electrical systems, powered ventilation and extinguish all smoking materials. **DO NOT** open the engine compartment hatch, this will feed oxygen to the fire and a flashback can occur. Allow the extinguishing agent to soak the generator compartment for at least 15 minutes and wait for hot metals or fuels to cool before inspecting for cause or damage. Have an approved portable fire extinguisher at hand and ready for use and **DO NOT** breathe fumes or vapors caused by the fire.

It is extremely important that you read, understand and know how this system works, refer to the manufacturer’s literature.

9.6 Carbon Monoxide Hazards

DANGER

CARBON MONOXIDE HAZARD

Exposure to CO will cause death or serious injury. CO is colorless, odorless and extremely dangerous. Avoid CO exposure and make sure the CO detector is working properly.

Carbon monoxide (CO) poisoning is lethal and should not be confused with seasickness, intoxication or heat exhaustion. If someone complains of irritated eyes, headache, nausea, weakness or dizziness, or you suspect carbon monoxide poisoning, immediately move the person to fresh air, investigate the cause, and take corrective action. Seek medical attention if necessary.

All engines and fuel burning appliances produce CO as exhaust. Direct and prolonged exposure to CO will cause **BRAIN DAMAGE** or **DEATH**.

Other symptoms that may signal exposure to CO: dizziness, flushed face, ears ringing, headaches, tightness of chest or hyperventilation, drowsiness, fatigue or weakness, inattention or confusion, lack of normal coordination, nausea and unconsciousness. The victim's skin also may turn red. A slight buildup of CO in the human body over several hours causes headache, nausea and other symptoms similar to food poisoning, motion sickness or the flu. Anyone with these symptoms should immediately be moved to an area of fresh air. Have the victim breathe deeply and seek immediate medical attention. To learn more about CO poisoning, contact your local health authorities.

Carbon Monoxide Detector

If the carbon monoxide detector is activated, this indicates the presence of CO, which can be fatal. Evacuate the cabin immediately. Make sure all passengers are accounted for. DO NOT enter the cabin until you know it is safe and the problem found and corrected.

CO detectors warn occupants of dangerous accumulation of CO gas. It is automatically activated whenever the house battery switch panel feed breaker is "ON." When powered, the green indicator will flash for ten to fifteen minutes, indicating the unit is in its warm-up stage. The green power indicator will stop flashing when the sensor has reached optimum operating temperature. The indicator will then switch from flashing green to solid green, indicating the detector is activate.

Make sure the battery switch is on and the power light is lit whenever the cabin is occupied.

This device uses a micro controller to continuously measure and accumulate CO levels. Should a very high level of CO exist, the alarm will sound within a few minutes. If small quantities are present or high levels are short-lived, the detector will accumulate the information and determine when an alarm level has been reached.

While a CO detector enhances your protection from CO poisoning, it does not guaran-

tee it will not occur. Do not use CO detectors as a replacement for ordinary precautions or periodic inspections of equipment. Never rely on alarm systems to save lives; common sense is still the best form of protection. Remember, the boat operator carries the ultimate responsibility to make sure the boat is properly ventilated and passengers are not exposed to dangerous levels of CO. Be alert to the symptoms and early warning signs of carbon monoxide.

CO detectors are very reliable and rarely sound false alarms. If the alarm sounds, DO NOT think it is false. If anyone has been exposed to CO, move them into fresh air immediately. Never disable the CO detector because you think the alarm may be false.

Carbon Monoxide Poisoning

Carbon monoxide (CO) is a by-product of combustion, is invisible, tasteless, odorless and is produced by all engines and most heating and cooking appliances. It exists wherever fuels are burned to generate power or heat. The most common sources of CO on boats are combustion engines, auxiliary generators and propane or butane stoves.

These produce large amounts of CO and should never be operated while sleeping. High concentrations of CO can be fatal within minutes. Many cases of CO poisoning indicate that while victims are aware they are not well, they become so disoriented they are unable to save themselves by either exiting the area or calling for help. Also, young children, elderly persons and pets may be the first affected. Drug or alcohol use increases the effect of CO exposure. Individuals with cardiac or respiratory conditions are very susceptible to the dangers of CO. CO poisoning is especially dangerous during sleep while victims are unaware of any side effects.

Low levels of CO over an extended period of time can be just as lethal as high doses over a short period. Therefore, low levels of CO can cause the alarm to sound before persons notice any symptoms.

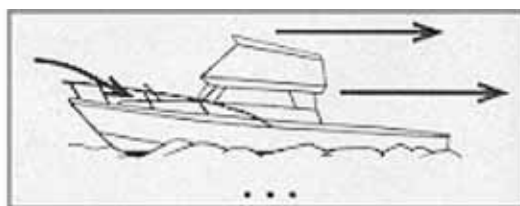

OPERATING SAFELY

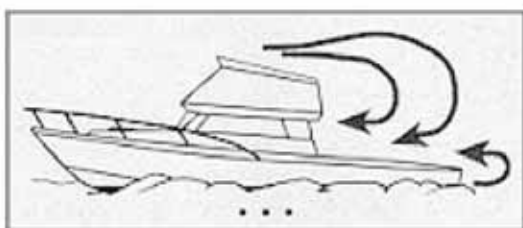

BACK DRAFTING / STATION WAGON EFFECT



NEARBY BOAT GENERATOR EXHAUST

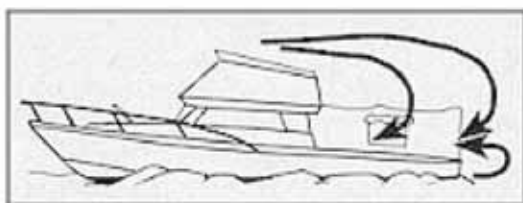

BACK DRAFTING / STATION WAGON EFFECT

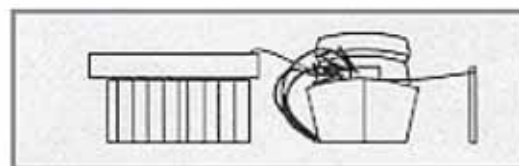

ONBOARD BOAT GENERATOR EXHAUST

Contact the detector manufacturer, the Pursuit Customer Relations Department or your local fire department for assistance in finding and correcting the situation.

In certain situations, boats can have a problem due to the “station wagon effect” where engine exhaust fumes are captured in the vessel by the vacuum or low pressure area, usually the cockpit, bridge deck and cabin, that can be created by the forward speed of the boat. Boats that are underway should close all aft facing portholes, hatches and doors. The forward facing deck hatches should be open whenever possible to help pressurize living spaces of the boat. Sleeping, particularly in aft cabins, should not be permitted while underway. Proper ventilation must be maintained on the bridge deck by opening a forward window or windshield to drive fumes away from the occupants. The canvas drop or aft curtain must be removed and side curtains should be opened or removed to increase airflow and maintain

proper ventilation whenever the engines are running.

DO NOT operate the engines with side curtains closed and the aft or drop curtain installed.

Use extreme caution while anchored or in a slip and an auxiliary power generator is operating. Calm wind nights can easily allow fumes to enter the boat. Inspect the exhaust systems of propulsion and the auxiliary generators, if equipped, frequently for possible leaks. High concentrations of CO in your boat can originate from an adjacent boat through open hatches or windows.

Failure to properly ventilate the boat while the engines are running can cause CO to accumulate within the cabin. Make sure to ventilate the boat and to avoid CO from accumulating in the boat whenever an engine is running.

Read the book entitled, "Sportfish, Cruisers, Yachts - Owner's Manual" and the owner's manual supplied by the CO detector manufacturer for additional information regarding the hazards and symptoms of CO gas, CO poisoning and operation instructions. If you did not receive these manuals, contact the Pursuit Customer Relations Department.

Many manufacturers of carbon monoxide detectors offer a testing and recertification program. We recommend that you contact the manufacturer of your CO detector and have it tested and recertified periodically. Certain electronic equipment have a limited life span, follow the CO detectors manufacturers recommendations on when the detector must be replaced.

9.7 First Aid

It is the boat operator's responsibility to be familiar with proper first-aid procedures and be able to care for minor injuries or illnesses of your passengers. In an emergency, you could be far from professional medical assistance, so be prepared. We recommend you be prepared by receiving training in basic first aid and CPR, through classes given by the Red Cross or your local hospital.

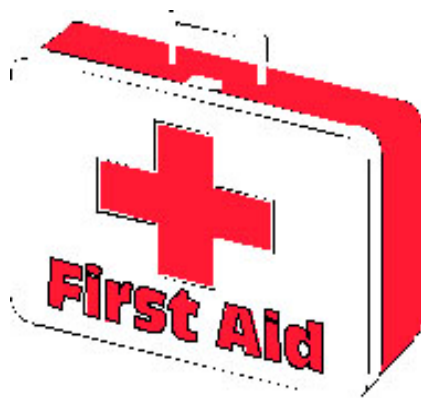

Equip your boat with at least a simple marine first-aid kit and a first-aid manual. The marine first-aid kit should be designed for the marine environment and be well supplied. Keep it accessible so each person onboard knows where it is located. As supplies are used, replace them. Some common drugs and antiseptics can lose their strength or become unstable as they age.

Ask a medical professional about the supplies you should carry and the safe shelf life of prescription drugs or other medical supplies you carry. Replace old supplies whether they have been used or not.

In many emergency situations, the Coast Guard can provide assistance in obtaining medical advice for treatment of serious injuries or illness. If you are within VHF range of a Coast Guard Station, make the initial contact on channel 16 and follow their instructions.

9.8 Required Safety Equipment

In addition to items installed by Pursuit, certain other equipment is required by the U.S. Coast Guard to help ensure passenger safety. Items like a sea anchor, working anchor, extra dock lines, flare pistol, life vests, a line permanently secured to your ring buoy, etc., could at some time save your passengers' lives, or save your boat from damage. Refer to the "Federal Requirements and Safety Tips for Recreational Boats" pamphlet for a more detailed description of the required equipment. You can also contact the U.S. Coast Guard Boating Safety Hot line, 800-368-5647, for information on boat safety courses and brochures listing the Federal equipment requirements. Also, check your local and state regulations.

The Coast Guard Auxiliary offers a "Courtesy Examination." This inspection will help ensure your boat is equipped with all of the necessary safety equipment.

The following is a list of the accessory equipment required on your boat by the U.S. Coast Guard:

Personal Flotation Devices (PFD's)

PFD's must be Coast Guard approved, in good and serviceable condition, and of appropriate size for the intended user. Wearable PFD's must be readily accessible, meaning you must be able to put them on in a reasonable amount of time in an emergency. Though not required, the Coast Guard emphasizes that PFD's should be

worn at all times when the vessel is underway. Throwable devices must be immediately available for use. All Pursuit boats must be equipped with at least one Type I, II or III PFD for each person onboard, plus one throwable device (Type IV).

Visual Distress Signals

All Pursuit boats used on coastal waters, the Great Lakes, territorial seas, and those waters connected directly to them, must be equipped with Coast Guard approved visual distress signals. These signals are either Pyrotechnic or Non-Pyrotechnic devices.

Pyrotechnic Visual Distress Signals

Pyrotechnic visual distress signals must be Coast Guard approved, in serviceable condition and readily accessible. They are marked with a date showing the service life, which must not have expired. A minimum of three are required. Some pyrotechnic signals meet both day and night use requirements. They should be stored in a cool, dry location. They include;

- pyrotechnic red flares, hand held or aerial.
- pyrotechnic orange smoke, hand-held or floating.
- launchers for aerial red meteors or parachute flares.

Pyrotechnics are universally recognized as excellent distress signals. However, there is potential for injury and property damage if not handled properly. These devices produce a very hot flame and the residue can cause burns and ignite flammable material. Pistol launched and hand-held parachute flares and meteors have many characteristics of a firearm and must be handled with caution. In some states they are considered a firearm and prohibited from use. Make sure you are careful and follow the manufacturer's instructions when using pyrotechnic distress signals.

WARNING

FIRE/EXPLOSION HAZARD
Pyrotechnic signaling devices can cause fire and/or explosion, death, serious injury and property damage if misused. Follow the manufacturer's directions in the use of these signaling devices.

Non-Pyrotechnic Devices

Non-Pyrotechnic visual distress signals must be in serviceable condition, readily accessible, and certified by the manufacturer as complying with U.S. Coast Guard requirements. They include:

Orange Distress Flag, day use only.

The distress flag is a day signal only. It must be at least 3 x 3 feet with a black square and ball on an orange background. It is most distinctive when attached and waved from a paddle or boat hook.

Electric Distress Light, night use only.

The electric distress light is accepted for night use only and must automatically flash the international SOS distress signal. Under Inland Navigation Rules, a high intensity white light flashing at regular intervals from 50-70 times per minute is considered a distress signal.

Sound Signaling Devices

The navigation rules require sound signals to be made under certain circumstances. Recreational vessels are also required to sound fog signals during periods of reduced visibility. Therefore, you must have some means of making an efficient sound signal.

Navigation Lights

Recreational boats are required to display navigation lights between sunset and sunrise and other periods of reduced visibility (fog, rain, haze, etc.) Navigation lights are intended to keep other vessels informed of

your presence and course. Your Pursuit boat is equipped with the navigation lights required by the U.S. Coast Guard at the time of manufacture. It is up to you to make sure they are visible, operational and turned on when required.

Fire Extinguishers

Pursuit Boats provides locations for two fire extinguishers on boats under 26 feet. Boats over 26 feet have provisions for up to three fire extinguishers. Boats equipped with cabins have one fire extinguisher located in the cabin, cockpit and helm areas. Center console boats have fire extinguishers mounted in the vicinity of the helm and passenger cockpit. Coast Guard approved fire extinguishers are hand-portable, either B-I or B-II classification and have a specific marine type mounting bracket. It is recommended the extinguishers be mounted in a readily accessible position.

Fire extinguishers require regular inspections to ensure:

- seals and tamper indicators are not broken or missing.
- pressure gauges or indicators read in the operable range.
- no obvious physical damage, corrosion, leakage or clogged nozzles.

For information on the type and size fire extinguisher required for your boat, refer to the "Federal Requirements and Safety Tips for Recreational Boats" pamphlet or contact the U.S. Coast Guard Boating Safety Hot line, 1-800-368-5647.

For instructions on the proper maintenance and use of your fire extinguisher, refer to the information provided by the fire extinguisher manufacturer.

Information for halon or agent FE-241 extinguishers is provided by the manufacturer. It is extremely important that you read, understand and know how this system works; refer to the manufacturer's literature.

Bilge And Fuel Fires

Fuel compartment and bilge fires or explosions are dangerous because of the presence of fuel. You must make the decision to fight the fire or abandon the boat. If the fire cannot be extinguished quickly or it is too intense to fight, abandoning the boat may be your only option. You must consider your safety, the safety of your passengers, the intensity of the fire and the possibility of an explosion in your decision.

If you find yourself in this situation, make sure all passengers have a life preserver on and go over the side and swim well upwind of the boat, to keep clear of any burning fuel that could be released and spread on the water as the boat burns or in the event of an explosion. When clear of the danger, check and account for all passengers who were onboard. Give whatever assistance you can to anyone in need or in the water without a buoyant device. Keep everyone together for morale and to aid rescue operations.

WARNING

BURN HAZARD

Fuel floating on water which is ignited can cause death or serious injury. Fuel will float on top of water and can burn. If the boat is abandoned, swim upwind, far enough to avoid fuel that can spread over the surface of the water.

9.9 Additional Safety Equipment

Besides meeting the legal requirements, prudent boaters carry additional safety equipment. This is particularly important if you operate your boat offshore. You should consider the following items, depending on how you use your boat.

Satellite EPIRB 'S

EPIRB's (Emergency Position Indicating Radio Beacon) operate as part of a world wide distress system. When activated, EPIRB's will send distress code homing beacons that allow Coast Guard aircraft to identify and find them quickly. The satellites that receive and relay EPIRB signals are operated by the National Oceanic and Atmospheric Administration (NOAA) in the United States. The EPIRB should be mounted and registered according to the instructions provided with the beacon, so the beacon's unique distress code can be used to quickly identify the boat and owner.

Additional Equipment to Consider:

- VHF Radio
- Life Raft
- Spare Anchor
- Spare Keys
- Heaving Line
- Fenders
- First Aid Kit
- Portable Radio
- Flashlight and Batteries
- Mirror
- Searchlight
- Sunburn Lotion
- Tool Kit
- Ring Buoy
- Whistle or Horn
- Anchor
- Chart and Compass
- Boat Hook
- Spare Propellers
- Mooring Lines
- Food and Water
- Binoculars
- Sunglasses
- Marine Hardware
- Extra Clothing
- Spare Parts

Operation

10.1 General

Before you start, become familiar with the various component systems and their operation, and perform a "Pre-Cruise System Check." A thorough understanding of the component systems and their operation is essential to operate the boat safely. This manual and the associated manufacturers' information have been provided to enhance your knowledge of your boat. Read them carefully, and also, read the book titled "Sportfish, Cruisers, Yachts - Owner's Manual."

Your boat must have the necessary safety equipment onboard and be in compliance with the U.S. Coast Guard, local and state safety regulations. There should be one Personal Floatation Device (PFD) for each person. Non-swimmers and small children should wear PFD's at all times. You should know and understand the "Rules of the Road" and have had an experienced operator brief you on the general operation of your new boat. At least one other person should be instructed on the proper operation of the boat in case the operator is suddenly incapacitated.

The operator is responsible for his safety and the safety of his passengers. When boarding or loading the boat, always step onto the boat, never jump.

 **WARNING**

DROWNING OR LOSS OF CONTROL HAZARD

Ejection or sudden loss of control can cause death or serious injury from improper use of seating. DO NOT stand while driving above engine idle speeds and make sure cockpit seat is locked/secured and all passengers are seated when boat is underway.

DO NOT allow passengers to sit on the seat backs, gunwales, bows, transoms or on fishing seats whenever the boat is underway.

Passengers should be seated to properly balance the load and must not obstruct the operator's view, particularly to the front.

Overloading and improper distribution of weight can cause the boat to become unstable and are significant causes of accidents. Know the weight capacity and horsepower rating of your boat. Do not overload or overpower your boat.

 **WARNING**

OVERLOAD HAZARD

Overloading the boat beyond maximum load or altering the stability, buoyancy or center-of-gravity can result in death or serious injury. DO NOT exceed the maximum load or alter the center-of-gravity of the boat.

Remember, it is the operator's responsibility to use good common sense and sound judgment in loading and operating the boat.

 **WARNING**

SLIPPERY SURFACE HAZARD

Wet surfaces can generate slippery conditions which can result in death or serious injury. Use caution on wet surfaces.

10.2 Homeland Security Restrictions

- Recreational boaters have a role in keeping our waterways safe and secure. Violators of the restrictions below can expect a quick and severe response:
- Do not approach within 100 yards, and slow to minimum speed within 500 yards of any U.S. Naval vessel. If you need to pass within 100 yards of a U.S. Naval vessel, for safe passage you must contact the U.S. Naval vessel or the Coast Guard escort vessel on VHF-FM channel 16.
- Observe and avoid all security zones. Avoid commercial port areas, especially those that involve military, cruise-line or

petroleum facilities. Observe and avoid other restricted areas near dams, power plants, etc.

- Do not stop or anchor beneath bridges or in channels.

America's Waterway Watch

America's Waterway Watch, a combined effort of the Coast Guard and its Reserve and Auxiliary, wants your help in keeping America's waterways safe and secure. America's Waterway Watch urges you to adopt a heightened sense of sensitivity toward unusual events or individuals you may encounter in or around ports, docks, marinas, riversides, beaches or waterfront communities. To report suspicious activities, call the National Response Center at 1-877-24WATCH or 1-800-424-8802. If there is immediate danger to life or property call 911 or call the Coast Guard on Marine channel 16.

10.3 Rules of the Road

As in driving an automobile, there are a few rules you must know for safe boating operation. The following information describes the basic navigation rules and action to be taken by vessels in a crossing, meeting or overtaking situation while operating in inland waters. These are basic examples and not intended to teach all the rules of navigation. For further information consult the "Navigation Rules" or contact the Coast Guard, Coast Guard Auxiliary, Department of Natural Resources, or your local boat club. These organizations sponsor courses in boat handling, including sponsor rules of the road. We strongly recommend such courses. Books on this subject are also available from your local library.

When two motor boats are crossing, the boat on the right has the right of way and should maintain its course and speed. The other vessel should slow down and permit it to pass. Both boats should sound appropriate signals.

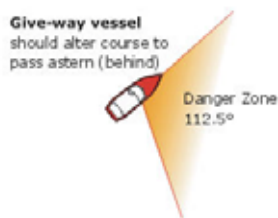

CAUTION

Avoid collisions by following navigation rules. If a collision appears unavoidable, both vessels must act. Prudence takes precedence over right-of-way rules if a crash is imminent. Less maneuverable boats generally have the right of way. Steer clear of the right-of-way boat and pass to its stern.

When two motor boats are crossing, the boat on the right has the right of way and should maintain its course and speed. The other vessel should slow down and permit it to pass. Both boats should sound appropriate signals.

Crossing situations

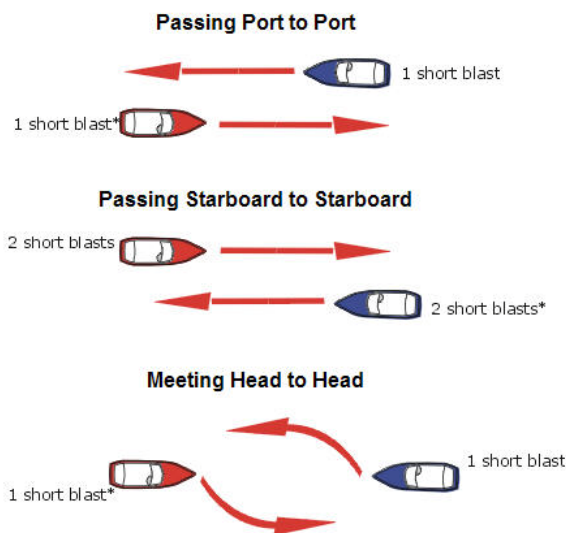

* Response not sounded on International Waters

Meeting Head-On Or Nearly-So Situations

When two motorboats are approaching each other head-on or nearly head-on, neither boat has the right of way. Both boats should reduce their speed and turn to the right, passing port side to port side and provide enough clearance for safe passage. Both boats should sound appropriate signals.

Overtaking Situations

When one motorboat is overtaking another motorboat, the boat being passed has the right of way. The overtaking boat must make adjustments necessary to provide clearance for a safe passage of the other vessel and should sound appropriate signals.

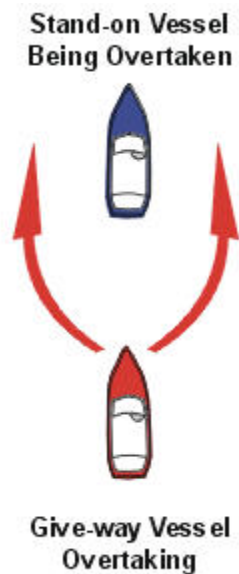

The General Prudential Rule

In obeying the Rules of the Road, due regard must be given to all dangers of navigation and collision and to any special circumstances, including the limitations of the vessels, which may justify a departure from the rules that is necessary to avoid immediate danger or a collision.

Navigation Aids

Aids to navigation are placed along coasts and navigable waters as guides to mark safe water and to assist mariners in determining their position in relation to land and hidden dangers. Each aid to navigation is used to provide specific information. Become familiar with these and any other markers used in your boating area.

Port Side Lateral System As seen entering from seaward (Green Light Only Odd Numbered Aids)		Starboard Lateral System As seen entering from seaward (Red Light Only Even Numbered Aids)	
	Green Light Chart Symbol "1" Fl G 6s		Red Light Chart Symbol "2" Fl R 6s
	Green Lighted Buoy Chart Symbol G "9" Fl G 4s		Red Lighted Buoy Chart Symbol R "8" Fl R 4s
	Can Chart Symbol G C "7"		Nun Chart Symbol R N "6"
	Daymark Chart Symbol G "1"		Daymark Chart Symbol R "2"

CAUTION

Storms and waves can move buoys, do not rely on buoys alone to determine your position.

10.4 Pre-Cruise Check

Before Starting The Engines:

- Check the weather forecast. Decide if your planned cruise can be made safely.
- Make sure all required documents are onboard.
- Make sure all necessary safety equipment is onboard and operative; items like running lights, spotlight, life saving devices, etc. Refer to Safety Equipment for additional information.

Each person onboard must have at least one personal flotation device onboard and one throwable device. Check the U.S. Coast Guard standards for the correct type required for your boat.

- Make sure signal kits are onboard and are in good operating condition and are not expired.
- Make sure you have sufficient water and other provisions for the planned cruise.
- Leave a written message listing details of your planned cruise (Float Plan) with a close friend ashore. Include a description of your boat, where you intend to cruise, schedule of your arrival in the cruising area and when you expect to return. Keep the person informed of any changes in your plan to prevent false alarms. This information can tell authorities where to look and your boat type in the event you fail to arrive.
- Check the amount of fuel onboard. Observe the “rule of thirds”: one third of the fuel for the trip out, one third to return and one third in reserve. An additional 15% may be consumed in rough seas.
- Check the water separating fuel filters for water.
- Turn on the battery switches.
- Check for bilge water and for other signs of potential problems. Monitor for the scent of fuel fumes.
- Test the automatic and manual bilge pump switches to make sure the system is working properly.
- Have a tool kit and spare parts onboard.

The kit should include basic tools:

- Spark Plug Wrench
- Hammer
- Spark Plug Gap Gauge
- Electrician’s Tape
- Screwdrivers
- Lubricating Oil
- Pliers
- Jackknife
- Adjustable Wrench
- Vise Grip Pliers
- Needle Nose Pliers
- Wire Crimping Tool
- End Wrench Set
- Wire Connector Set

The spare parts kit should include:

- Extra Light Bulbs
 - Spark Plugs
 - Fuses and Circuit Breakers
 - Flashlight and Batteries
 - Drain Plugs
 - Engine Oil
 - Propellers
 - Fuel Filters
 - Propeller Nuts
 - Fuel Hose and Clamps
- Make sure all fire extinguishers are in position and in good operating condition.
 - Make sure the shift control is in NEUTRAL.
 - Make sure the emergency engine stop lanyard is attached to the operator and the stop switch.

10.5 Operating your Boat

The operator must be seated, and ready with the controls (steering/throttle) when the engine is started or running.

After Starting the Engines:

- Check engine gauges. Make sure all are reading normally.
- Visibly check engines to be sure there are no apparent water, fuel or oil leaks.
- Check operation of engine cooling systems.
- Check controls and steering for smooth and proper operation.
- Allow engines to warm up for 10 to 15 minutes before operating them above idle speeds.
- Make sure all lines, cables, anchors, etc. for securing the boat are onboard and in good condition. All lines should be coiled, secured and off the decks when underway.
- Have a safe cruise and enjoy yourself.

REMEMBER:

When operating a boat, you accept the responsibility for the boat, safety of passengers and others out enjoying the water.

- Alcohol and any mind altering chemicals can severely reduce your reaction time and affect your better judgment.
- Alcohol reduces the ability to react.
- Alcohol makes it difficult to judge speed and distance or track moving objects.
- Alcohol reduces night vision and ability to distinguish red from green.

STAY ALERT. The use of alcohol or any other mind altering chemicals that impair judgment, pose a serious threat to you and others. The boat operator is responsible for their consequences and behavior of passengers.

⚠ WARNING

IMPAIRED OPERATION HAZARD
Operating any boat while intoxicated or under the influence of other drugs can cause death or serious injury. DO NOT operate any boat under the influence of any mind-altering chemical.

Avoid sea conditions that are beyond the skill and experience of you and your crew.

Make sure at least one other person onboard is instructed in the operation of the boat and it is operated in compliance with all state and local laws.

DO NOT operate the boat unless it is completely assembled. Make sure all fasteners are tight and adjustments are to specifications.

Before operating the boat for the first time, read the engine break-in procedures. Refer to the engine owner's manual. Since different types of engines are used, have your dealer describe the operating procedures for your boat. For more instructions on "How to Operate the Boat," read the instructions given to you for your engines.

For more instructions on safety, equipment and boat handling, enroll in one of the several free boating courses offered. For information on the courses offered in your area, call the "Boating Safety Hot line," 800-368-5647.

If the drive unit hits an underwater object, stop the engine. Inspect drive unit for damage. If damaged contact your dealer for a complete inspection and repair of the unit.

Stopping the Boat

- Allow engines to drop to the idle speed.
- Shift controls to NEUTRAL.

If the engines have been run at high speed for a long period of time, allow engines to cool by running at idle for 3 to 5 minutes.

- Turn the ignition keys "OFF."
- Raise the trim tabs to full "UP" position.

⚠ CAUTION

Turn off engines at idle speed. Racing the engine before switching it off can draw water into the engine through the exhaust, resulting in internal damage.

After operation:

- If operated in saltwater, wash the boat and all equipment with soap and water. Flush the engines using fresh water. Refer to the engine owner's manual for instructions on flushing.
- Check the bilge area for debris and excess water.
- Fill the fuel tanks to near full to reduce condensation. Allow room in the tanks for the fuel to expand without being forced out the vent.
- Turn off all electrical equipment except the automatic bilge pumps.
- If you are going to leave the boat unattended for a long period of time, put the battery main switches to "OFF" and close all seacocks.
- Make sure the boat is securely moored.

⚠ CAUTION

To prevent damage, close all sea-cocks before leaving the boat.

10.6 Fishing

Fishing can be very exciting and distracting for the operator of the boat when the action gets intense. Be conscious that your primary responsibility is operating the boat safely to protect yourself, your passengers and other boats around you. Make sure the helm is properly manned and is never left unattended while trolling.

If you are fishing in an area that is crowded with other fishing boats, it may be difficult to follow the rules of the road. This situation can become especially difficult when most boats are trolling. Be courteous and exercise good common sense. Avoid trying to assert your right of way and stay clear to preventing tangled or cut lines and other unpleasant encounters. Also, keep in mind that fishing line wrapped around a propeller shaft can cause damage to the lower unit seal.

10.7 Tower Operation (Dealer Installation)**Operation of the Tower Controls**

Start engines at the lower helm. Monitor gauges to make sure all systems are normal and engines are warmed up before proceeding to the tower helm. The ignition or restart switches on the tower are only used to restart an engine in the event it should stall. The shift controls must be in neutral for the restart switches to be functional.

Safety precautions for tower operation:

- Do not operate boat from tower in rough sea conditions. Motions of the boat are exaggerated in the tower and may become excessive in rough seas.
- Be careful when using the trim tabs from the tower. The reaction of the trim tabs will be exaggerated in the tower. Use small tab corrections and wait ten (10) seconds for the tabs to react. Keep making small corrections until the hull is at the desired attitude.
- Do not overload the tower. Most towers are designed for two average-sized people and weight in the tower affects the center of gravity and motion of the boat is greatly exaggerated for the people in a tower, too much weight can make the boat unstable.
- Do not operate the boat in tight quarters, such as marinas, from the tower. The operator is isolated from the boat while in the tower and will not be able to assist in docking procedures.
- Avoid using the tower in wet or rough weather, your grip and footing on the tower ladders is reduced.
- Operating the boat from the tower in unfamiliar waters or where running aground, can eject the operator or passengers.
- Be alert for waves and boat wakes; the motion of the boat is exaggerated in the tower.
- Exercise good common sense and judgment when operating a boat from the tower.
- If the engine alarm sounds, put the boat in NEUTRAL and shut "OFF" the engine immediately until the problem is found.
- Always put the boat in NEUTRAL before moving to and from the tower helm and cockpit.

Use common sense, judgment and exercise caution when operating the boat with someone in the tower. DO NOT allow anyone in the tower when the water is rough or when operating in unfamiliar waters where running aground is a possibility. Remember, weight in the tower affects center of gravity and motion of the boat is greatly exaggerated for people in the tower.

10.8 Docking, Anchoring and Mooring

Docking and Docklines

Maneuvering a boat near a dock and securing it requires skill and techniques that are unique to water and wind conditions, and the dock layout. If possible, position a crew member at the bow and stern to assist with the lines and docking. While maneuvering close to the dock, compensate for wind and current, and anticipate how you can use them to help docking. Practice in open water using an imaginary dock to develop a sense for how the boat handles in different scenarios. You must be able to understand docking techniques before problems occur.

Approaching a dock or backing into a slip in high winds or strong currents requires skill. If you are new to handling a boat, take lessons from an experienced pilot and learn to maneuver in tight quarters in less than ideal conditions. Also, practice away from the dock during windy conditions.

Dock lines are generally twisted or braided nylon. Nylon is strong and stretches to absorb shock. Nylon also has a long life and is soft and easy on the hands. The size of the line, will vary with the size of the boat. Typically a 30 to 40 foot boat will use 5/8-inch line and a 20 to 30 foot boat will use 1/2-inch line. The number of lines and their configuration will vary depending on the dock, the range of the tide, and other factors. Usually a combination of bow, stern and spring lines is used to secure the boat.

Maneuvering to the Dock

Approach the dock slowly at a 30 to 40 degree angle. When possible, approach against the wind or current. Turn the engines straight and shift to neutral when you feel you have enough momentum to reach the dock. Use reverse to slow the boat and pull the stern toward the dock as the boat approaches. If you approached properly, the boat will lightly touch the pilings at the same time forward momentum is stopped. Have the dock lines ready and secure the boat as

soon as it stops. Use fenders to protect the boat while it is docked. Keep the engines running until the lines are secured.

Backing into a Slip

Approach the slip with the stern against the wind or current and the engines straight ahead. Use the engines and turn the steering wheel to maneuver the boat into alignment with the slip. Reverse the engines and slowly back into the slip. Shift from reverse to neutral frequently at idle to prevent the boat from gaining too much speed. Move the stern right and left by shifting the engines in and out of gear or turning the wheel. When nearly in the slip all the way, straighten the engines and shift to forward to stop. Keep the engines running until the lines are secured.

Securing Docklines

Securing a boat along side the dock typically requires a bow and stern line and two spring lines. The bow and stern lines are usually secured to the dock at a 40 degree angle aft of the stern cleat and forward of the bow cleat. The after bow spring line is secured to the dock at a 40 degree angle aft of the after bow spring cleat. The forward quarter spring is secured to the dock at a 40 degree angle forward of the stern cleat. The spring lines keep the boat square to the dock and reduce fore and aft movement while allowing the boat to move up and down with the tide.

Securing a boat in a slip is somewhat different. It typically requires two bow lines secured to pilings on each side of the bow, two stern lines secured to the dock and two spring lines that prevent the boat from hitting the dock. The bow lines are typically secured with enough slack to allow the boat to ride the tide. The stern lines are crossed. One line runs from the port aft boat cleat to the starboard dock cleat and the other line runs from the starboard aft boat cleat to the port cleat on the dock. The stern lines center the boat, control the forward motion and allow the boat to ride the tide. Two forward quarter spring lines typically are secured to the stern cleats and to mid ship pilings or

cleats. The spring lines keep the boat from backing into the dock while allowing it to ride the tide.

Leaving the Dock

Start the engines and let them warm up for 10 to 15 minutes before releasing the lines. Boats steer from the stern and it is important you achieve enough clearance at the stern to maneuver the boat as quickly as possible. Push the stern off and maneuver to gain stern clearance quickly. Proceed slowly until the boat has cleared the dock and other boats.

Mooring

Approach the mooring buoy heading into the wind or current. Shift to neutral when you have just enough headway to reach the buoy. Position a crew member on the bow to retrieve the buoy with a boat hook and secure the line. Keep the engines running, until the line is secure.

Leaving a Mooring

Start the engines and let them warm up before releasing the mooring line. The boat will already be headed into the wind, so move it forward enough to loosen the line and untie it. Back the boat away until you can see the buoy and slowly move away.

Anchoring

Make sure the bitter end of the anchor rode is attached to the boat before dropping the anchor. Bring the bow into the wind or current and put the engine in neutral. When the boat comes to a stop, lower the anchor over the bow. Allow enough rode so that it is at least 5 to 7 times the depth of the water and secure the line to a cleat. Use caution to avoid getting your feet or hands tangled in the line. Additional scope of 10 times the depth may be required for storm conditions. Check landmarks on shore to make sure the anchor is not dragging. If it is dragging, start over. It is prudent to use two anchors if you are anchoring overnight or in rough weather.

WARNING

SINKING OR DROWNING HAZARD
Anchoring at the stern can pull a boat under water. **DO NOT** anchor at the stern.

Releasing the Anchor

Release the anchor by traversing to the point where the anchor line becomes vertical. It should release when you pass that point. If the anchor does not release, stop the boat directly above the anchor and tie the line to a cleat as tight as possible. The up and down movement of the boat will usually loosen the anchor. Make sure the anchor is secured and stowed before getting underway.

10.9 Controls, Steering or Propulsion System Failure

WARNING

MOVING PARTS HAZARD
Contact with moving parts can entangle, cut and cause death or serious injury. **DO NOT** come close enough to make contact with any running machinery moving parts, i.e., engine or propeller. Contact can result in loss of body parts, strangulation, burns and/or severe loss of blood resulting in serious injury or death.

The engine covers are machinery guards and must be in place whenever the engines are running. **DO NOT** operate the boat without the covers in place unless you are performing a check or maintenance.

If the propulsion, control or steering system fails while you are operating the boat, bring both throttles to idle and shift to neutral. Determine if the boat should be anchored to prevent the boat from drifting or to hold the bow into the seas. Investigate and correct the problem if possible. Make sure the engines are off before investigating the prob-

lem. If you are unable to correct the problem, call for help.

If only one engine has failed, you can operate on one engine. Do not to apply too much power to the running engine. When running one engine to power a twin engine boat, the engine is “over propped” and can be overloaded if too much throttle is applied. Contact your dealer or the engine manufacturer for the maximum power settings when running on one engine.

10.10 Collision

If your boat is involved in a collision with another boat, dock, piling or a sandbar, your first priority is to check passengers for injuries and administer first aid if necessary. Once all passengers’ situations are stabilized, thoroughly inspect the boat for damage. Check below decks for leaks and all control systems for proper operation. Plug all leaks or make the necessary repairs to the control systems before proceeding. Operate slowly and carefully, but take all necessary precautions to be safe. Request assistance if necessary. Haul the boat and make a thorough inspection of the hull, lower unit and control system for damage.

10.11 Grounding, Towing and Rendering Assistance

The law requires the owner or operator of a vessel to render assistance to any individual or vessel in distress, as long as his vessel is not endangered in the process.

If the boat should become disabled, or if another craft that is disabled requires assistance, be careful. The stress applied to a boat during towing can become excessive. Excessive stress can damage the structure and create a safety hazard for all onboard.

Freeing a grounded vessel, or towing a disabled boat requires specialized equipment and knowledge. Line failure and structural damage caused by improper towing have resulted in fatal injuries. To safely accomplish the towing task, we recommend this to be reserved for those with the right equip-

ment and knowledge, e.g., the U.S. Coast Guard or a commercial towing company.

The mooring cleats or bow/stern eyes on Pursuit boats are not designed or intended to be used for towing or lifting. These cleats are designed as mooring cleats for securing the boat to a dock, pier, etc. only. DO NOT use these fittings for towing, lifting or attempting to free a grounded vessel.

When towing operations are underway, have everyone on both vessels stay clear of the tow line and surrounding area. DO NOT allow anyone to be in line with the tow rope; a dangerous, recoil can occur if the rope should break or pull free.

Running aground can cause serious injury to passengers and damage the boat and its underwater gear.

If your boat runs aground, evaluate the damage, then proceed at low speed to the nearest service facility and have an immediate inspection made before further use. A damaged boat can also take on water; keep all life saving devices close while heading to a dock area. If the boat cannot be immediately removed from the water, thoroughly inspect the bilge area for leaks.

10.12 Flooding or Capsizing

Boats can become unstable if they become flooded or completely swamped. Always be aware of the position of the boat to the seas and the amount of water in the bilge. Water entering the boat over the transom can usually be corrected by turning the boat into the waves. If the bilge is flooding because of a hole in the hull, the engine bracket or a defective hose, you may be able to plug it with rags, close the thru-hull valve or assist the pumps by bailing with buckets. Put a mayday call into the Coast Guard or nearby boats and distribute life jackets as soon as you discover your boat is in trouble.

If the boat becomes swamped and capsizes, you and your passengers should stay with the boat as long as you can. It is much easier for the Coast Guard, aircraft, or other boats to spot, than people in the water.

10.13 Transporting your Boat

Your Pursuit boat is a large boat and should only be trailered by professionals with the right equipment and knowledge to transport large boats without causing damage. Contact your dealer or the Pursuit Customer Relations Department if you are planning to transport your boat and have any questions in regard to the proper equipment and support for the hull.

Damaged from trailers can occur if the boat hull is not supported properly. Make sure the trailer bunks and pads are adjusted so they provide enough support for the hull and are not putting excessive pressure on the lifting strakes. Hull damage resulting from improper trailer support is not covered by the Pursuit warranty.

10.14 Trailering your Boat

The boat trailer is an important part of your boating package. The trailer must be matched to the weight of the boat. A trailer with a capacity too low will be unsafe on the road and cause abnormal wear. A trailer with a capacity too high, can damage the boat. Contact your dealer to evaluate your towing vehicle and hitch, and to make sure you have the correct trailer for your boat.

IMPORTANT

Your Pursuit is heavy and the selection of your trailer is very important. We recommend using a bunk style trailer that incorporates a combination of heavy duty rollers to support the keel and long bunks running under and parallel to the stringers to support the hull. Trailers without bunks can cause damage and have a tendency to put extreme pressure points on the hull, especially on the lifting strakes. The situation worsens when launching or retrieving. Damage resulting from improper trailer support or the use a full roller trailer will not be covered by the Pursuit Warranty.

If you trailer your boat, make sure your tow vehicle is capable of towing the weight of the trailer, boat and equipment and the weight of the passengers and equipment inside the vehicle. This may require the tow vehicle to be specially equipped with a larger engine, transmission, brakes and trailer tow package.

The following safety tips and a book titled "Sportfish, Cruisers, Yachts - Owner's Manual," included in your literature packet, provide additional information you should know before trailering your boat.

DO NOT use bow or stern eyes, cleats or any other hardware for the purpose of towing, being towed or lifting, they are not designed for that purpose.

Contact your dealer to evaluate your towing vehicle and hitch, and to make sure you have the correct trailer for your boat.

- Make sure the trailer is a match for the weight and hull design of the boat. More damage can occur by the stresses of road travel than by normal water operation. A boat hull is designed to be supported evenly by water. So, when it is transported on a trailer it should be supported as evenly across the hull as possible allowing for even distribution of the weight of the hull, engine and equipment.
- Make sure the trailer bunks and rollers properly support the hull and do not put pressure on the lifting strakes. The rollers and bunks must be kept in good condition to prevent scratching and gouging of the hull.
- The capacity rating of the trailer should be greater, but not to an extreme, than the combined weight of the boat, motor, and equipment. The gross vehicle weight rating must be shown on the trailer. Make sure the weight of the boat, engine, gear and trailer is not more than the gross vehicle weight rating.
- **DO NOT** use your boat and trailer as a means for hauling excess gear.
- Make sure the boat is securely fastened on the trailer to prevent movement between the boat and trailer. The bow

rope, chain or turnbuckle in addition to the winch cable. Additional straps may be required across the beam of the boat. If these types of straps are used, protect your boat from chaffing or from the straps “slapping” the gelcoat. Cover area where straps are secured and twisting the straps before they are secured will help reduce the “slapping” affect. Your dealer can provide instructions on how to load, fasten and launch your boat.

Before Going out on the Highway:

- **Canvas Enclosures** - must be removed when trailering. Canvas enclosures will be damaged, they are not designed to withstand the extreme wind pressure encountered while trailering. Remove and properly store enclosures before trailering.
- **Tow Ball And Trailer Coupler** - make sure they are the same size and bolts and nuts are tightly secured.

The coupler **MUST BE** completely over the ball and the latching mechanism **LOCKED DOWN**.

- **Load Trailer Evenly** - make sure load is evenly distributed from front to rear, as well as side to side and has the correct distribution of weight on the hitch. Too much weight on the hitch will cause the rear of the tow vehicle to drag and may make steering more difficult. Too little weight on the hitch will cause the rig to fishtail and will make controlling the tow vehicle difficult. Contact your Pursuit dealer or the trailer manufacturer for the correct weight on the hitch for your trailer.
- **Safety Chains** - attach crisscrossing under the coupler to the frame of the tow vehicle. If the ball breaks, the trailer would follow in a straight line and prevent the coupler from dragging on the road. Make sure the trailer emergency brake cable or chain is also installed to the tow vehicle frame.
- **Lights** - make sure they are functioning properly.
- **Brakes** – check on a level parking area; roll forward and apply the brakes several

times at increasing speeds to determine if the brakes on the tow vehicle and trailer are working properly.

- **Side View Mirrors** - make sure the tow vehicle mirrors are large enough to provide an unobstructed rear view on both sides of the vehicle.
- **Tires and Wheel Bearings** – check before getting on the road.

Make sure your tow vehicle and trailer are in compliance with all state and local laws for the area you will be trailering. Contact your state motor vehicle bureau for laws governing the towing of trailers.

10.15 Water Skiing

Your Pursuit can be equipped for water skiing. If you have never pulled skiers, you should observe, learn and practice from an experienced driver. If you are an experienced driver, become familiar with the boat and the way it handles before pulling a skier. The driver should also know the ability of the skiers and drive accordingly. The following safety precautions should be observed while towing water skiers.

- Water ski only in safe areas, away from other boats and swimmers, out of channels and in water free of underwater obstructions and water ski only during daylight hours.
- Make sure that anyone who skis can swim. DO NOT allow people who cannot swim to water ski.
- Make sure all skiers wear a proper life jacket. A water skier is considered onboard the boat and a Coast Guard approved life jacket is required. A skier should wear a flotation device designed to withstand the impact of hitting the water at high speed. A second person must be onboard to observe the skier so your attention can be directed to the safe operation of the boat.
- Approach a skier in the water from the downwind side and STOP THE ENGINE and forward motion of the boat before coming in close proximity to the skier.
- Give immediate attention to a fallen skier. A fallen skier is very hard to see by other boats and is extremely vulnerable.

When a skier falls, be prepared to turn the boat immediately and return to the skier. Never leave a fallen skier alone in the water for any reason.

For additional information on water skiing, including hand signals and water skiing manuals, contact the American Water Skiing Association - 863-324-4341 or visit their Web Site at www.usawaterski.org.

DANGER

CARBON MONOXIDE POISONING AND/OR ROTATING PARTS HAZARD
Poisonous CO gases are present at the rear of the boat when an engine is running. A rotating propeller can cut or entangle swimmers, both of these hazards will cause death or serious injury. DO NOT use the swim/boarding platform when the engine is running.

Remove and store the ladder properly before starting the engines.

10.16 Man Overboard

If someone falls overboard, be prepared to react quickly, especially when you are offshore. The following procedures will help you in recovering a person that has fallen overboard.

- Immediately stop the boat and sound a man overboard alarm and have all passengers point to the person in the water.
- Circle around quickly and throw a throwable PFD, cushion or life jacket to the person and if possible, another to use as a marker.
- Keep the person on the driver side of the boat to keep them in sight.
- Approach the person from the downwind side and maneuver the boat so the propellers are well clear of the person in the water.
- Turn off the engines when person is alongside and use a ring buoy or a boat cushion with a line attached, a paddle or boathook to assist person to the boat;

make sure you do not hit them with the ring buoy or the boat.

- Pull person to the boat and assist onboard.
- Check person for injuries and administer first aid if necessary, if the injuries are serious, call for help immediately.

Refer to Safety Equipment for more information on first aid and requesting emergency medical assistance.

10.17 Trash Disposal

The discharge of plastic trash or trash mixed with plastic is illegal anywhere in the marine environment. It is also illegal to discharge garbage in the navigable waters of the United States including the great lakes.

Regional, State, and local restrictions on garbage discharges also may apply. Vessels of 26 feet or longer must display in a prominent location, a durable placard at least 4 by 9 inches notifying the crew and passengers of the discharge restrictions.

Responsible boaters store refuse in bags and disposed of it properly on shore. Make sure your passengers are aware of the local waste laws and the trash management procedure on your boat.

Routine Maintenance

11.1 General

WARNING

FIRE/EXPLOSION/ASPHYXIATION HAZARD

Cleaning agents and paint ingredients can be flammable and/or explosive, or dangerous to inhale. Make sure ventilation is adequate, wear proper personal protection and dispose of rags properly ashore.

Vapors from flammable solvents can cause fire, explosion or asphyxiation resulting in death or serious injury. Keep open flame or spark away from work area. **DO NOT** paint unless in a well-ventilated area.

Before using a cleaning product, refer to the product directions and specifications.

If urethane foam is used in the construction of your boat, be careful with high temperatures or flames in these areas. Urethane foam can ignite. **DO NOT** smoke, weld or burn. Avoid the use of space heaters and lights in areas where urethane foam is present. If ignited, urethane foam burns rapidly, produces extreme heat, releases hazardous gases and consumes much oxygen.

11.2 Exterior Hull and Deck

Hull Cleaning - Below the Waterline

When the boat is removed from the water, clean the outer bottom surface immediately. Algae, grass, dirt and other marine growth can be removed easier while the hull is still wet. Use a pressure cleaner or a hard bristle brush to clean the surface.

Bottom Painting

If the boat is to be left in saltwater for extended periods, protect it from marine growth by applying an antifouling paint. Because of variations in water temperature,

marine growth and pollution in different regions, your dealer and/or a qualified boat yard in your area should be consulted when deciding what bottom paint system to apply to your hull, because pollution and marine growth can damage fiberglass hulls.

Sanding or sandblasting the hull bottom will damage the fiberglass. Only use standard antifouling paints and fiberglass wax removers and primers recommended by the antifouling paint manufacturer when preparing the hull for bottom paint. Sanding or sandblasting and the use of a coating other than standard antifouling paint or epoxy barrier coatings are not recommended and will void the hull blister warranty.

DO NOT allow antifouling paint to contact the outboard engine. Most antifouling paints contain copper which will cause severe galvanic damage to the motor. Leave a 1/2" (12.7 mm) barrier between the hull bottom paint and outboard engine.

Most bottom paints require maintenance, especially when the boat is in saltwater or not used for extended periods, or after dry storage. If the hull bottom has been painted with antifouling paint, contact your dealer for the recommended maintenance procedures.

Sacrificial Anodes

Sacrificial zinc anodes are installed on the trim tabs, transom and outboard engines. The transom anode is connected to the bonding system and protects the underwater hardware that is bonded.

The anodes are less noble than copper based alloys and aluminum and will deteriorate first, protecting the more noble underwater hardware against galvanic corrosion. Anodes should be checked monthly and changed when they are 75% of their original size. When replacing the anodes, make sure the contact surfaces are clean, shiny metal and free of paint and corrosion. Never paint over the anode or protect it.

Boats stored in saltwater will require anodes to be replaced at least every 6 months to one year. Anodes requiring replacement

more frequently may indicate a stray current problem within the boat or at the slip or marina. Anodes that do not need to be replaced after one year may not be providing the proper protection. Loose or low quality anodes could be the problem. Contact your dealer for the proper size and type of anodes to be used and the specific installation procedure.

Fiberglass Gelcoat Surfaces

Normal maintenance requires only washing with mild soap and water. A stiff brush can be used on the nonskid areas. Kerosene or commercially prepared products will remove oil and tar which could be a problem on trailered boats. DO NOT use harsh abrasive and chemical cleaners because they can damage or dull the gelcoat, reducing its life and making it more susceptible to stains. When the boat is used in saltwater, wash it thoroughly with soap and water after each use.

Sudden changes in temperature can affect gelcoat. When planning on moving your boat from outdoors to a heated location, allow the change of temperature to be gradual. Warm the location slowly after the boat is brought inside to allow the boat to change temperature slowly as the location is warmed. Or, if you are moving your boat from a warmer area to a colder one, wait for the temperature to be closer to the temperature of the warmer area or allow the warmer area and the boat to cool down.

At least once a season, wash and wax all exposed fiberglass surfaces. Use a high quality automotive or boat wax. Follow the procedure recommended by the wax manufacturer. Washing and waxing of your boat will have the same beneficial effects as they have on an automobile finish. The wax will fill minute scratches and pores which help prevent soiling and will extend the life of the gelcoat.

After the boat is exposed to the direct sunlight for a period of time, the color in the gelcoat tends to fade, dull or chalk from oxidation of the gel. This condition will be more apparent with dark colors, which

require more frequent maintenance. A heavier buffing is required to bring the gelcoat back to its original luster. For power cleaning use a light cleaner. To clean the boat by hand, use a heavier automotive cleaner. Before cleaning the surfaces, read the instructions given with the cleaner. After cleaning the surfaces, apply wax and polish all fiberglass surfaces except the nonskid areas.

If the fiberglass should become damaged and need repair, contact your dealer for an authorized repair person to make the repairs.

WARNING

SLIPPERY SURFACE HAZARD
Cleaning surfaces can generate slippery conditions which can result in death or serious injury. Use caution when cleaning with detergents. Rinse thoroughly.

Be careful when walking on wet gelcoat surfaces.

DO NOT wax nonskid surfaces, these could make them slippery and increase the possibility of injury.

Stainless Steel Hardware

When using the boat in saltwater, wash hardware with soap and water after each use. When your boat is used in a higher corrosive environment, such as saltwater, water with a higher sulfur content or polluted water, stainless steel will periodically develop surface rust stains; this is normal under these conditions.

Clean and protect by using a high quality boat or automotive wax or a commercial metal cleaner and protector.

DO NOT use citrus-based, abrasive materials such as sandpaper, bronze wool, or steel wool on stainless steel as damage will result.

Anodized Aluminum Surfaces

Wash periodically with soap and water to keep it clean. If the boat is used in saltwater or polluted water, wash with soap and water after each use. Saltwater allowed to remain on anodized aluminum will penetrate the anodized coating and attack the aluminum.

Hardtops with aluminum frames, bimini tops and towers with canvas and/or fiberglass tops require special attention to the anodized aluminum just below the top. This area is subject to salt build-up from salty condensation and sea spray. It is often overlooked when the boat is washed and will not be rinsed by the rain. The aluminum just below the top is more likely to become pitted than the exposed aluminum on the structure. Make sure these areas are washed frequently with soap and water and rinsed thoroughly. Pay particular attention to places where the top material and lacing contact the frame. Coat the entire frame with a metal protector made for anodized aluminum once a month to protect against pitting and corrosion caused by the harsh effects of saltwater. The anodized aluminum used on your Pursuit was coated with a metal protector called Aluma Guard at the factory. Aluma Guard is a nonabrasive marine metal protector that protects anodized aluminum, stainless steel, brass and chrome. It also protects color anodizing from fading and discoloring due to harmful ultraviolet rays. Aluma Guard is available from your dealer or Rupp Marine Inc., 4761 Anchor Avenue, P.O. Drawer F, Port Salerno, FL 34992.

Aluma Guard and other metal protectors can make the metal slippery and should not be used on tower ladders, steering wheels and other areas for gripping or stepping.

Stains can be removed with a metal polish or fine polishing compound. To minimize corrosion, use a caulking compound to bed hardware and fasteners mounted to aluminum fabrications. If the anodized coating is badly scratched it can be touched up with paint. With proper care, anodized aluminum will provide many years of service.

Contact Pursuit Customer Relations before making any modifications to aluminum fabrications. Unauthorized modifications can void the warranty.

Powder Coated (Painted) Aluminum Surfaces

Regular care is necessary to maintain the appearance of the powder coat finish. Build-up of salt and grime can hold moisture and damage powder coatings. This buildup can cause a corrosive condition that can damage the coating, especially in a salt air or coastal environment.

- Wash the finish regularly with warm water containing a pH neutral detergent (i.e. mild dish soap).
- Use a non-abrasive fiber cloth.
- Rinse thoroughly after cleaning.

Chrome Hardware

Rinse with fresh water and wipe dry with towel or chamois after each use. Use a good chrome cleaner and polish on all chrome hardware. Clean and wax chrome prior to extended storage. In saltwater or other harsh environments, clean and wax more often.

Acrylic Plastic

Acrylic plastic scratches easily. DO NOT use a dry cloth or glass cleaning solutions on acrylic. Use a soft cloth and mild soap and water for routine cleaning. Solvents and products containing ammonia can permanently damage acrylic plastic.

Fine scratches can be removed with a fine automotive clear coat polishing compound. A coat of automotive or boat wax is beneficial to protect the surface.

DO NOT use the following on acrylic plastic:

- Abrasive cleaners
- Acetone
- Solvents
- Alcohol
- Glass cleaners
- Cleaners containing ammonia

Engines

Proper engine maintenance is essential to performance and reliability of your outboard engines. Maintenance schedules and procedures are outlined in your engine owner's manual, follow them exactly.

Flush the system when the boat is out of the water. If the boat is used in saltwater, flush daily.

The age of gasoline can affect engine performance. Chemical changes occur as the gasoline ages, causing deposits and varnish in the fuel system and reduces the octane rating of the fuel. Degraded fuel can damage the engine and boat fuel tank and lines. If your boat does not require at least one full tank of fresh fuel a month, add a fuel stabilizer to the gasoline to protect the fuel from degradation. Use only a fuel stabilizer recommended by your dealer or the engine manufacturer. Operate the boat at least 15 minutes after adding the stabilizer to allow the treated fuel to reach the engine. Your dealer or engine manufacturer can provide additional information on fuel degradation. For more recommendations for your specific area, check with your local Pursuit dealer.

Avoid using fuels with alcohol additives. Gasoline, extended with an alcohol blend, will absorb moisture from the air which can reach such concentrations that "phase separation" can occur where the water and alcohol mixture becomes heavy enough to settle out of the gasoline to the bottom of the tank. Since the fuel pick-up tube is near the bottom of the tank, phase separation can cause the engine to run poorly or not at all. This condition is more severe with methyl alcohol and will worsen as the alcohol content increases. Water or a jelly like substance in the fuel filters is an indication of possible

phase separation from the use of alcohol blended fuels.

Contact your Pursuit dealer or engine manufacturer for additional information regarding fuels and additives.

Corian® Surfaces

Corian® is resistant to heat, but you should always use a hot pad or a trivet with rubber feet to protect Corian®. Avoid exposing Corian® to strong chemicals, such as paint removers, oven cleaners, etc. If contact occurs, flush the surface with water immediately. Soapy water or ammonia-based cleaners will remove most dirt and stains from all types of finishes.

DO NOT use the Corian® counter top as a cutting board.

Minor damage, scratches, general or chemical stains, scorching or burns and minor impact marks can be repaired on-site with a light abrasive cleanser and a product such as a Scotch-Brite® pad. For heavier damage, light sanding may be necessary. Heavy damage should be repaired by a Corian® licensed professional.

Tempered Glass Sink

For best results:

- DO NOT use strong/abrasive cleaner. Test your cleaning solution on an unnoticeable area first, before applying to the entire surface.
- Wipe surfaces clean, immediately after applying cleaner.
- DO NOT allow cleaner to sit or soak on the surface.
- DO NOT use an abrasive brush or scouring pad to clean surfaces as damage will occur. Use only a soft, dampened sponge and cloth.
- Rinse and wipe the fixtures to prevent soap build-up.

11.3 Seats, Upholstery, Canvas and Enclosures

Seat Slides and Swivel Bases

Perform the following periodically:

- Inspect and tighten mounting screws between seat slides and seat bottom.
- Inspect and tighten the mounting screws attaching seat bases to boat.
- Keep a light film of grease on manual seat slides.
- Keep a light film of grease on manual seat adjusting mechanism.
- Clean electric seat slides. DO NOT use harsh chemicals or abrasives. Lubrication is not required.

Vinyl Upholstery

The vinyl upholstery used on the exterior seats and bolsters and headliner in the cabin should be cleaned with soap and water periodically. Stains, spills or soiling should be cleaned up immediately to prevent the possibility of permanent staining. When cleaning, rub gently. DO NOT use products containing ammonia, powdered abrasive cleaners, steel wool, strong solvents, acetone and lacquer solvents or other harsh chemicals as they can permanently damage or shorten the life of vinyl. Never use steam heat, heat guns or hair dryers.

Stronger cleaners, detergents and solvents may be effective in stain removal, but can cause either immediate damage or slow deterioration. Lotions, sun tan oil, waxes and polishes, etc., contain oils and dyes that can cause stiffening and staining of vinyls.

- Dry soil, dust and dirt - remove with a soft cloth.
- Dried on dirt - wash with a soft cloth dampened with water.
- Variations in surface gloss - wipe with a water-dampened soft cloth and allow to air dry.
- Stubborn dirt - wash with a soft cloth, dampened with Ivory Flakes® and water. Rinse with clean water.

- Stubborn spots and stains - spray with either Fantastik Cleaner® or Tannery Car Care Cleaner® and rub with a soft cloth. Rinse with clean water.
- Liquid spills - wipe with a clean absorbent cloth immediately. Rinse with clean water.
- Food grease and oily stains - spray with either Fantastik Cleaner® or Tannery Car Care Cleaner®, wiping with a soft cloth immediately. Be careful not to extend the area of contamination beyond its original boundary. Rinse with clean water.

Canvas and Side Curtains

Acrylic canvas should be cleaned periodically by using a mild soap and water. Scrub lightly and rinse thoroughly to remove the soap. Do not use detergents. The top or accessories should never be folded or stored wet.

After several years, the acrylic canvas may lose some of its ability to shed water. If this occurs, wash the fabric and treat it with a commercially available water proofing designed for this purpose. Some leakage at the seams is normal and unavoidable with acrylic enclosures.

Side curtains and clear connectors can be cleaned with mild soap and water. Do not allow them to become badly soiled. Dirt, oil, mildew, and cleaning agents containing ammonia will shorten the life of the vinyl that is used for clear curtains. After cleaning the curtains and allowing them to dry, apply a non-lemon furniture polish or an acrylic plastic and clear plastic protector to extend the life of the curtains.

Vinyl curtains should be stored either rolled or flat, without folds or creases. Folding the curtains will make permanent creases that could cause the vinyl to crack.

DO NOT use any polish containing lemon or lemon scents; lemon juice attacks vinyl and shorten its life.

Lubricate snaps periodically with petroleum jelly or silicone grease. Lubricate zippers with silicone spray or paraffin.

Remove the bimini top, side curtains, clear connector, back drop and aft curtain when trailering. Canvas enclosures are not designed to withstand the extreme wind pressure encountered while trailering and will be damaged. Always remove and store properly before trailering.

11.4 Cabin Interior

Clean cabin interior just like you would clean a home interior.

- Teak woodwork - use teak oil.
- Carpeting - use a vacuum cleaner.
- Vinyl headliner - clean as previously explained.

Air and sunlight are very good cleansers. Periodically, place cushions, sleeping bags, etc. on deck, under the sun and fresh air to dry and air out. If cushions or equipment get wet with saltwater, remove and use clean, fresh water to rinse off the salt crystals. Salt retains moisture and will cause damage. Dry thoroughly and reinstall.

If you leave the boat for a long period of time, put all cushions on their sides, open all interior cabin and locker doors, and hang a commercially available mildew protector in the cabin.

Read the label carefully on mildew protectors and remove the protector and allow the cabin to ventilate completely before using the cabin.

11.5 Bilge

To keep the bilge clean and fresh, use a commercial bilge cleaner regularly. Follow the directions carefully. All exposed pumps and metal components should be sprayed with a protector periodically to reduce the corrosive effects of the high humidity present in these areas.

WARNING

FIRE/EXPLOSION OR ASPHYXIATION HAZARD!

Fumes from flammable solvents can cause fire, explosion or asphyxiation resulting in death or serious injury. DO NOT use flammable solvents to clean the bilge.

11.6 Generator (Optional)

The engine maintenance required on the generator is similar to an inboard engine. The engine incorporates a pressure-type lubrication system and a fresh water cooled engine block which is thermostatically controlled. The most important factors to the longevity of the generator is proper ventilation and maintenance of the fuel system, ignition system, cooling system, lubrication system and the AC alternator.

Maintenance schedules and procedures are outlined in the generator owner's manual; follow them exactly.

Seasonal Maintenance

12.1 Storage and Lay-up

Before Hauling:

- Pump out the head. Flush the holding tank using clean soap, water, deodorizer and pump out cleaning solution.
- Leave the fuel tank nearly full to reduce condensation that can accumulate in the tank. Allow enough room for fuel to expand without leaking from the vents. Algae can grow in the accumulated water in diesel fuel tanks, especially in warm climates. Adding a high quality diesel fuel additive containing an algaecide may be required to control algae during storage in your area.
- Drain fresh water system.
- Refer to the engine owner's manual for detailed information on preparing the engines for storage.

Lifting

It is essential that care be used when lifting your boat. Make sure the spreader bar at each sling is at least as long as the distance across the widest point of the boat that the sling will surround. Put the slings in position. Refer to the drawing in the Schematics for the correct position of the lifting slings. The positions are marked with small labels on each side of the boat under the rubrails. Tie fore and aft slings together to prevent slings from sliding on the hull.

Elevating lifts are commonly used to store boats for extended periods. To provide proper support, the bunks that support the hull should be aligned with and run parallel to the hull stringers. The bow and stern eyes, if equipped should not be used as sole support for storage.

Your boat can be damaged from improper lifting and rough handling when being transported by lift trucks. Care and proper handling procedures must be used when using a lift truck to move your boat. DO NOT attempt to lift boat with a substantial amount of water in the bilge.

Severe gelcoat cracking or more serious hull damage can occur during hauling and launching if pressure is created on the gunwales (sheer) by the slings. Use flat, wide slings and spreaders long enough to keep pressure from the gunwales. DO NOT allow your boat to be hauled when the spreaders on the lift are not wide enough to take the pressure off the gunwales.

Supporting The Boat for Storage

A trailer, elevating lift or a well-made cradle is the best support for your boat during storage.

When storing the boat on a trailer for a long period:

- Make sure the rollers and pads support the hull of the boat and the trailer is on a level surface with the bow high enough so water will drain from the bilge and cockpit. The trailer must properly support the hull. The bunks and rollers should match the bottom of the hull and should not be putting pressure on the lifting strakes.
- Make sure the hitch is properly supported.
- Check the tires once each season. Add enough air for the correct amount of inflation for the tires.
- Make sure the engines are in the down position.

When storing the boat on a lift or cradle:

- The cradle must be specific for boat storage. Make sure lift or cradle is well supported with the bow high enough to provide proper drainage of the bilge. The cradle or lift must be in the proper fore and aft position to properly support the hull. When the cradle or lift is in the correct location, the bunks should match the bottom of hull and should not be putting pressure on the lifting strakes.
- Make sure the engines are in the down position.
- Make sure bunks and rollers are adjusted so they are not putting pressure on lifting strakes and are providing enough support for the hull. Hull damage

resulting from improper cradle or trailer support is not covered by the Pursuit warranty.

Preparing The Boat For Storage:

- Remove the bilge drain plug(s), if installed.
- Thoroughly wash fiberglass exterior, especially the antifouling portion of the bottom. Remove as much marine growth as possible. Lightly wax the exterior fiberglass components.
- Remove all oxidation from the exterior hardware and apply a light film of moisture displacing lubricant.
- Remove propellers and grease the propeller shafts using light waterproof grease.
- Remove batteries and clean using clear, clean water. Make sure batteries have sufficient water and terminals are clean. Keep the batteries charged and stored in a cool, dry place and safe from freezing throughout the storage period.
- Refer to the Electrical System for information on the maintenance of the AC and DC electrical systems.
- Coat all faucets and exposed electrical components in the cabin and cockpit with a protecting oil.
- Clean, drain and completely dry the fish-boxes, sinks and livewells.
- Thoroughly clean the interior of the boat; vacuum all carpets and dry clean drapes and upholstery.
- Remove cushions, open the refrigerator/cooler door and as many locker doors as possible. Leaving as many of these areas open as possible will improve fresh air ventilation during the storage period.
- Place a mildew preventive system in the cabin area before it is closed for storage.
- Clean the exterior upholstery with a good vinyl cleaner and dry thoroughly. Spray the weather covers and boat upholstery with a spray disinfectant. Enclosed areas such as the refrigerator, shower basin, storage locker areas, etc. should also be sprayed with a disinfectant.

12.2 Winterizing

Fresh Water System

The entire fresh water system must be completely drained. Disconnect all hoses, check valves, etc. and blow all the water from the system. Make sure the water heater and fresh water tank are completely drained. Use very low air pressure only when blowing water from the system to prevent damage to components. The check valve mechanism built in the fresh water pump will not remove the water from the pump. Remove the outlet hose on the pump, turn it on and allow it to pump out any remaining water, approximately a cupful.

An alternate method is to use commercially available nontoxic, fresh water system antifreeze. After draining the potable water tank, lines and water heater, pour the antifreeze mixture into the fresh water tank, prime and operate the pump until the mixture flows from all fresh water faucets. Be sure to open ALL faucets, including the fresh water spray head in the stern bait station sink and the water supply valve for the head. Make sure antifreeze has flowed through all of the fresh water drains. Allow the antifreeze to fill the sink traps to trap odors from the waste tank.

The shower/cabin drain sump system must be winterized also. Clean debris from the drain and sump and flush for several minutes with fresh clean water. After the system is clean, pump the drain sump as dry as possible. Then pour a potable water antifreeze mixture into the shower drain until antifreeze has been pumped through the entire system and out of the thru-hull.

For additional information, refer to Plumbing Systems.

Raw Water System

Drain the raw water systems completely. Disconnect all hoses and blow the water from the system. Use very low air pressure only when blowing water from the system to prevent damage to components. The check valve mechanism built in the raw water

washdown pump, will not remove the water from the pump. Remove the outlet hose on the pump, turn it on and allow it to pump out any remaining water, approximately a cupful.

An alternate method is to use commercially available nontoxic, potable water system antifreeze. If antifreeze is used, pour the mixture into a pail and put the raw water intake lines into the solution. Run the pumps one at a time until the antifreeze solution is visible at all raw water faucets, discharge fittings and drains. Make sure antifreeze has flowed through all of the raw water drains.

Run the stern fishbox macerator pump until all the water is removed from the fishbox and the pump. To avoid damage to the pump, DO NOT run pump dry for more than ten seconds.

Generator Raw Water Systems

Drain sea strainer, heat exchangers and raw water supply and discharge lines for the optional generator raw water supply pumps. Make sure all sea water has drained from the exhaust system. Some generator engine mufflers have a drain plug that must be removed to properly drain the muffler. Once this is accomplished, pour a nontoxic marine engine antifreeze mixture into a large pail and put the generator raw water intake lines into the solution. Run the generator until the antifreeze solution is visible at the exhaust port, then shut the engine off.

Winterize the generator engine and fuel system by following the generator manufacturer's winterizing procedures. Refer to generator's owner's manuals or contact a Pursuit dealer.

Marine Toilet

Winterize the marine toilet following the manufacturer's winterizing procedures; follow the procedures exactly. Refer to the toilet owner's manual. Drain the intake and discharge hoses completely using low air pressure if necessary. The head holding tank and macerator discharge pump must be pumped dry and one gallon of potable water antifreeze poured into the tank

through the deck waste pumpout fitting. After the antifreeze has been added to the holding tank, open the overboard discharge valve and activate the macerator pump until the antifreeze solution is visible at the discharge thru-hull.

Air Conditioner

Disconnect and drain the air conditioner intake and discharge hoses. Remove all water from the sea strainer and thru-hull fitting. Allow all water to drain from the system. An alternate method is the use of commercially available nontoxic, potable water system antifreeze. If antifreeze is used, drain the sea strainer and pour the mixture into a pail and put the raw water intake line into the solution. Run the air conditioner until the antifreeze solution is visible at the discharge fitting on the hull side.

Air conditioner components must be winterized also; follow winterizing procedure in the air conditioner owner's manual.

The air conditioning, engine control system, head, and steering systems have specific lay-up requirements. Refer to the owner's manuals for recommended winterizing procedures.

Bilge

Coat all metal components, wire busses, connector plugs (in the bilge), all strainers, seacocks and steering components with a protecting oil. The bilge pumps and bilge pump lines must be completely free of water and dried out when the boat is laid up for the winter in climates where freezing occurs. Compartments in the bilge that will not drain completely should be pumped out and then sponged until completely free of water. Dry the hull bilge and self-bailing cockpit troughs. Water freezing in these areas could cause damage.

Hardtop

Makes sure all drain holes in the legs are open and legs are completely free of water. Remove the canvas and thoroughly clean

and store in a safe, dry place. Remove all electronics. Coat all wire connectors and bus bars in the helm compartment with a protecting oil.

Clean the aluminum frame with soap and water and dry thoroughly. Apply an aluminum metal protector to the entire frame to reduce corrosion and pitting.

NOTICE

Make sure the leg drain holes are clear when the boat is laid up for the winter. Water trapped inside the hardtop, tower or radar arch legs can freeze and cause the legs to split.

Tower (if installed)

Make sure all holes in the tower and hardtop legs are open and completely free of water. Check and clear tower basket drains of debris. Remove the tower sun shade, if installed, the belly band or other upholstery, thoroughly clean and store in a safe, dry place. Remove all electronics. Coat all wire connectors and bus bars in the helm compartment with a protecting oil. Cover the tower basket with a tarp and secure it properly.

Clean the aluminum frame with soap and water and dry thoroughly. Apply an aluminum metal protector to the entire frame to reduce corrosion and pitting.

Covering for Winter Storage

Proper storage is very important to prevent serious damage to the boat. If the boat is stored outside, support and secure a storage cover properly over the boat. It is best to have a frame built over the boat to support the canvas. It should be a few inches wider than the boat so the canvas will clear the rails and allow passage of air. If this cover is fastened too tightly there will be inadequate ventilation and can lead to mildew, moisture accumulation, etc. Fasten the canvas down securely so wind cannot remove it or cause chafing of the hull superstructure. DO NOT

store the boat in a damp storage enclosure. Excessive dampness can cause electrical problems, corrosion, and excessive mildew.

DO NOT use the bimini top or convertible top canvas in place of the winter storage cover. The life of these tops can be shortened if exposed to harsh weather elements for long periods.

DO NOT use an electric or fuel burning heating unit in the bilge area.

If the boat is to be stored indoors, make sure the building has enough ventilation and there is enough ventilation both inside the boat and around the boat. If the boat is to be stored indoors or outdoors, open all drawers, clothes lockers, cabinets, and doors a little. If possible, remove the upholstery, mattresses, clothing, and rugs.

12.3 Recommissioning

DO NOT operate the boat unless it is completely assembled. Keep all fasteners tight. Keep adjustments according to specifications.

Before launching the boat, make sure to install hull drain plug(s).

Reactivating The Boat After Storage:

- Charge and install the batteries.
- Install hull drain plug(s).
- Check the engines and generator for damage and follow the manufacturer's instructions for recommissioning.
- Check the mounting bolts of engines to make sure they are tight.
- Perform all routine maintenance.
- Check all hose clamps for tightness.
- Pump antifreeze from any systems winterized with antifreeze and flush several times with fresh water. Make sure all antifreeze is flushed from the water heater and it is filled with fresh water before it is activated.
- Check and lubricate the steering system.
- Clean and wash the boat.
- Install all upholstery, cushions and canvas.

After Launching:

- Check all water systems and the engine mounting bolts for leaks. Operate each system one at a time and check for leaks and proper operation.
- Check the bilge pump, manual and automatic switches.
- When the engines start, check the cooling system port below the engine cowling for a strong stream of water to ensure cooling pump is operating.
- Carefully monitor the gauges and check for leakage and abnormal noises.
- Operate boat at slow speeds until engine temperature stabilizes and all systems are operating normally.

Glossary of Terms

Aft: In, near, or toward the stern of a boat.

Aground: A boat stuck on the bottom.

Amidships: In or toward the part of a boat midway between the bow and stern.

Anchor: A specially shaped heavy metal device designed to dig efficiently into the bottom under a body of water and hold a boat in place.

Anchorage: An area specifically designated by governmental authorities in which boats may anchor.

Ashore: On shore.

Astern: Behind the boat, to move backwards.

Athwartship: At right angles to the center line of the boat.

Barnacles: Small, hard-shelled marine animals which are found in salt water attached to pilings, docks and bottoms of boats.

Beam: The breadth of a boat usually measured at its widest part.

Bearing: The direction of an object from the boat, either relative to the boat's direction or to compass degrees.

Berth: A bunk or a bed on a boat.

Bilge: The bottom of the boat below the flooring.

Bilge Pump: A pump that removes water that collects in the bilge.

Boarding: Entering or climbing into a boat.

Boarding Ladder: Set of steps temporarily fitted over the side of a boat to assist persons coming aboard.

Boat Hook: Short shaft of wood or metal with a hook fitting at one end shaped to aid in extending one's reach from the side of the boat.

Bow: The front end of a boat's hull.

Bow Line: A line that leads forward from the bow of the boat.

Bow Rail: Knee high rails of solid tubing to aid in preventing people from falling overboard.

Bridge: The area from which a boat is steered and controlled.

Bridge Deck: A deck forward and usually above the cockpit deck.

Broach: When the boat is sideways to the seas and in danger of capsizing; a very dangerous situation that should be avoided.

Bulkhead: Vertical partition or wall separating compartments of a boat.

Cabin: Enclosed superstructure above the main deck level.

Capsize: When a boat lays on its side or turns over.

Chock: A deck fitting, usually of metal, with inward curving arms through which mooring or anchor lines are passed so as to lead them in the proper direction both onboard and off the boat.

Cleat: A deck fitting, usually of metal with projecting arms used for securing anchor and mooring lines.

Closed Cooling System: A separate supply of fresh water that is used to cool the engine and circulates only within the engine.

Coaming: A vertical piece around the edges of cockpit, hatches, etc. to stop water on deck from running below.

Cockpit: An open space, usually in the aft deck, outside of the cabin.

Companionway: Opening in the deck of a boat to provide access below.

Compartment: The interior of a boat divided off by bulkheads.

Cradle: A framework designed to support a boat as she is hauled out or stored.

Cutlass Bearing: A rubber bearing in the strut that supports the propeller shaft.

Deck: The floor-like platform of a boat that covers the hull.

Displacement: The volume of water displaced by the hull. The displacement weight is the weight of this volume of water.

Draft: The depth of water a boat needs to float.

Dry Rot: A fungus attack on wood areas.

Dry-dock: A dock that can be pumped dry during boat construction or repair.

Electrical Ground: A connection between an electrical connector and the earth.

Engine Beds: Sturdy structural members running fore and aft on which the inboard engines are mounted.

EPIRB: Emergency Position Indicating Radio Beacon. Operates as a part of a worldwide satellite distress system.

Even Keel: When a boat floats properly as designed.

Fathom: A measure of depth. One Fathom = 6 feet.

Fender: A soft object of rubber or plastic used to protect the topsides from scarring and rubbing against a dock or another vessel.

Fend off: To push or hold the boat off from the dock or another boat.

Flying Bridge: A control station above the level of the deck or cabin.

Flukes: The broad portions of an anchor which dig into the ground.

Following Sea: A sea that comes up from the stern and runs in the same direction that the boat is going.

Fore: Applies to the forward portions of a boat near the bow.

Foundering: When a boat fills with water and sinks.

Freeboard: The height from the waterline to the lowest part of the deck.

Galley: The kitchen of a boat.

Grab Rail: Hand-hold fittings mounted on cabin tops or sides for personal safety when moving around the boat, both on deck and below.

Ground Tackle: A general term including anchors, lines, and other gear used in anchoring.

Grounds: A boat touches the bottom.

Gunwale: The upper edge of a boat's side.

Hand Rail: Rail mounted on the boat, for grabbing with your hand, to steady you while walking about the boat.

Harbor: An anchorage which provides reasonably good protection for a boat, with shelter from wind and sea.

Hatch: An opening in the deck with a door or lid to allow for access down into a compartment of a boat.

Head: A toilet on a boat.

Heat Exchanger: Used to transfer the heat that is picked up by the closed cooling system to the raw cooling water.

Helm: The steering and control area of a boat.

Hull: The part of the boat from the deck down.

Inboard: A boat with the engine mounted within the hull of the boat. Also refers to the center of the boat away from the sides.

Inboard/outboard: Also stern drive or I/O. A boat with an inboard engine attached to an outboard drive unit.

Keel: A plate or timber plate running lengthwise along the center of the bottom of a boat.

Knot: Unit of speed indicating nautical miles per hour. 1 knot = 1 nautical mile per hour (1.15 miles per hour). A nautical mile is equal to one minute of latitude: 6076 feet. Knots times 1.15 equals miles per hour. Miles per hour times .87 equals knots.

Lay-up: To decommission a boat for the winter (usually in northern climates).

Leeward: The direction toward which the wind is blowing.

Length On The Waterline (l.w.l.): A length measurement of a boat at the waterline from the stern to where the hull breaks the water near the bow.

Limber Hole: A passage cut into the lower edges of floors and frames next to the keel to allow bilge water to flow to the lowest point of the hull where it can be pumped overboard.

Line: The term used to describe a rope when it is on a boat.

Lists: A boat that inclines to port or starboard while afloat.

L.O.A.: Boat length overall.

Locker: A closet, chest or box aboard a boat.

Loran: An electronic navigational instrument which monitors the boat's position using signals emitted from pairs of transmitting stations.

Lunch hook: A small light weight anchor typically used instead of the working anchor. Normally used in calm waters with the boat attended.

Midships: The center of the boat.

Marina: A protected facility primarily for recreational small craft.

Marine Ways or Railways: Inclined planes at the water's edge onto which boats are hauled.

Moored: A boat secured with cables, lines or anchors.

Mooring: An anchor permanently embedded in the bottom of a harbor that is used to secure a boat.

Nautical Mile: A unit of measure equal to one minute of latitude. (6076 feet)

Nun Buoy: A red or red-striped buoy of conical shape.

Outboard: A boat designed for an engine to be mounted on the transom. Also a term that refers to objects away from the center line or beyond the hull sides of a boat.

Pad Eye: A deck fitting consisting of a metal eye permanently secured to the boat.

Pier: A structure which projects out from the shoreline.

Pile or Piling: A long column driven into the bottom to which a boat can be tied.

Pitching: The fore and aft rocking motion of a boat as the bow rises and falls.

Pitch: The measure of the angle of a propeller blade. Refers to the theoretical distance the boat travels with each revolution of the propeller.

P.F.D: Personal Flotation Device.

Port: The left side of the boat when facing the bow.

Porthole (port): The opening in the side of a boat to allow the admittance of light and air.

Propeller: A device having two or more blades that is attached to the engine and used for propelling a boat.

Propeller Shaft: Shaft which runs from the back of the engine gear box, aft, through the stuffing box, shaft log, struts, and onto which the propeller is attached.

Pyrotechnic Distress Signals: Distress signals that resemble the brilliant display of flares or fireworks.

Raw Water Cooled: Refers to an engine cooling system that draws sea water in through a hull fitting or engine drive unit, circulates the water in the engine, and then discharges it overboard.

Reduction Gear: Often combined with the reverse gear so that the propeller turns at a slower rate than the engine.

Reverse Gear: Changes the direction of rotation of the propeller to provide thrust in the opposite direction for stopping the boat or giving it sternway.

Roll: A boat's sideways rotational motion in rough water.

Rope Locker: A locker, usually located in the bow of a boat, used for stowing the anchor line or chain.

Rubrail: Railing (often rubber or hard plastic) that runs along the boat's sheer to protect the hull when coming alongside docks, piers, or other boats.

Rudder: A moveable flat surface that is attached vertically at or near the stern for steering.

Sea anchor: An anchor that does not touch the bottom. Provides drag to hold the bow in the most favorable position in heavy seas.

Scupper: An opening in the hull side or transom of the boat through which water on deck or in the cockpit is drained overboard.

Seacock: Safety valves installed just inside the thru-hull fittings and ahead of the piping or hose running from the fittings.

Shaft Log: Pipe through which the propeller shaft passes.

Sheer: The uppermost edge of the hull.

Sling: A strap which will hold the boat securely while being lifted, lowered, or carried.

Slip: A boat's berth between two pilings or piers.

Sole: The deck of a cockpit or interior cabin.

Spring Line: A line that leads from the bow aft or from the stern forward to prevent the boat from moving ahead or astern.

Starboard: The right side of a boat when facing the bow.

Steerageway: Sufficient speed to keep the boat responding to the rudder or drive unit.

Stem: The vertical portion of the hull at the bow.

Stern: The rear end of a boat.

Stow: To pack away neatly.

Stringer: Longitudinal members fastened inside the hull for additional structural strength.

Strut: Mounted to the hull which supports the propeller shaft in place.

Strut Bearing: See “cutlass bearing.”

Stuffing Box: Prevents water from entering at the point where the propeller shaft passes through the shaft log.

Superstructure: Something built above the main deck level.

Swamps: When a boat fills with water from over the side.

Swimming Ladder: Much the same as the boarding ladder except that it extends down into the water.

Taffrail: Rail around the rear of the cockpit.

Thru-hull: A fitting used to pass fluids (usually water) through the hull surface, either above or below the waterline.

Topsides: The side skin of a boat between the waterline or chine and deck.

Transom: A flat stern at right angles to the keel.

Travel Lift: A machine used at boat yards to hoist boats out of and back into the water.

Trim: Refers to the boat's angle or the way it is balanced.

Trough: The area of water between the crests of waves and parallel to them.

Twin-Screw Craft: A boat with two propellers on two separate shafts.

Underway: When a boat moves through the water.

Wake: Disrupted water that a boat leaves astern as a result of its motion.

Wash: The flow of water that results from the action of the propeller or propellers.

Waterline: The plane of a boat where the surface of the water touches the hull when it is afloat on even keel.

Watertight Bulkhead: Bulkheads secured so tightly so as not to let water pass.

Wharf: A structure generally parallel to the shore.

Working Anchor: An anchor carried on a boat for most normal uses. Refers to the anchor used in typical anchoring situations.

Windlass: A winch used to raise and lower the anchor.

Windward: Toward the direction from which the wind is coming.

Yacht Basin: A protected facility primarily for recreational small craft.

Yaw: When a boat runs off her course to either side.

Maintenance Schedule

Maintenance	Each Use	Weekly	Monthly	Semi-Annually	Yearly	As Nedeed
Clean hull below the waterline				X		
Bottom paint					X	X
Check sacrificial anodes			X			
Replace sacrificial anodes					X	
Wash boat canvas& hardware	X		X			
Wax exterior gelcoat				X		X
Clean & protect hardware						X
Polish & protect plastic glass					X	X
Clean exterior upholstery	X					X
Clean cabin & interior upholstery						X
Flush engine with fresh water	X					
Spray metal components in bilge with a protector			X			
Clean bilge				X		X
Check bilge for leaks	X		X			
Inspect & operate thru-hull valves			X			
Inspect steering & control systems	X					
Service steering & control systems				X		
Inspect fuel system for leaks	X					
Inspect & service fuel system				X		
Inspect fuel tank vents & screens					X	
Replace fuel filters					X	
Lubricate fuel fill O-rings			X			
Inspect fire extinguisher			X			
Test bilge pump auto switches	X					
Inspect & protect electrical components, wire & battery connections				X		
Check battery electrolyte & service			X			
Test and inspect AC electrical system & shore power cord				X		
Inspect water systems for leaks				X		
Check neutral safety switch	X					
Check trim tab fluid level			X			

Date	Hours	Dealer	Service/Repairs

Boating Accident Report

DEPARTMENT OF TRANSPORTATION U.S. COAST GUARD C.G. 1865 (REV. 1/88)		BOATING ACCIDENT REPORT			FORM APPROVED OMB NO. 211-0010			
The operator/owner of a vessel used for recreational purposes is required to file a report in writing whenever an accident results in: loss of life or disappearance from a vessel, or an injury which requires medical treatment beyond first aid: or property damage in excess of \$200 or complete loss of the vessel. Reports in death and injury cases must be submitted within 48 hours. Reports in other cases must be submitted within 10 days. Reports must be submitted to reporting authority in the state where the accident occurred. This form is provided to assist the operator in filing the required written report.								
COMPLETE ALL BLOCKS (indicate those not applicable by "NA")								
NAME AND ADDRESS OF OPERATOR		AGE OF OPERATOR DATE OF BIRTH		OPERATOR'S EXPERIENCE This type of boat Other boat operating Exp. [] Under 20 Hours [] Under 20 Hours [] 20 to 100 Hours [] 20 to 100 Hours [] 100 to 500 Hours [] 100 to 500 Hours [] Over 500 Hours [] Over 500 Hours				
OPERATOR TELEPHONE NUMBER		OWNER TELEPHONE NO.						
NAME AND ADDRESS OF OWNER		RENTED BOAT [] YES [] NO	NUMBER OF PERSONS ON BOARD	FORMAL INSTRUCTION IN BOATING SAFETY [] None [] State [] U.S. Power Squadrons [] USCG Auxiliary [] American Red Cross [] Other (Specify) _____				
VESSEL NO. (this vessel)								
BOAT REGISTER NO.	BOAT NAME	BOAT MAKE	BOAT MODEL	MFR HULL IDENTIFICATION NO.				
TYPE OF BOAT [] Open Motorboat [] Cabin Motorboat [] Auxiliary Sail [] Sail (only) [] Rowboat [] Canoe [] Other (Specify)	HULL MATERIAL [] Wood [] Aluminum [] Steel [] Fiberglass [] Rubber/vinyl [] Other (Specify)	ENGINE [] Outboard [] Inboard gasoline [] Inboard diesel [] Inboard-outdrive [] Jet [] Other (Specify)	PROPULSION No. of engines _____ Horse Power (total) _____ Type of fuel _____ Has boat had a Safety Examination? [] Outboard [] NO For current year? [] YES [] NO Year _____ Indicate whether [] USCG Auxiliary Courtesy Marine Exam [] State/local examination [] Other	CONSTRUCTION Length _____ Year built (boat) _____				
ACCIDENT DATA								
DATE OF ACCIDENT	TIME am pm	NAME OF BODY OF WATER		LOCATION (Give location precisely)	Lat Long	County		
STATE	NEAREST CITY OR TOWN			COUNTY				
WEATHER [] Clear [] Rain [] Cloudy [] Snow [] Fog [] Hazy	WATER CONDITIONS [] Calm (waves less than 6") [] Choppy (waves 6" to 2') [] Rough (greater than 6") [] Strong Current	TEMPERATURE (Estimate) Air _____ F° Water _____ F°	WIND [] None [] Light (0 - 6mph) [] Moderate (7 - 14 mph) [] Strong (15 - 25 mph) [] Storm (Over 25 mph)	VISIBILITY DAY NIGHT [] Good [] Fair [] [] Poor []				
OPERATION AT TIME OF ACCIDENT (Check all applicable) [] Commercial Activity [] Cruising [] Maneuvering [] Approaching Dock [] Leaving Dock [] Water Skiing [] Racing [] Towing [] Other (Specify)	TYPE OF ACCIDENT (Check all applicable) [] Drifting [] At Anchor [] Tied to Dock [] Fueling [] Fishing [] Hunting [] Skin Diving/ Swimming [] Being Towed	[] Grounding [] Collision with [] Capsizing Fixed Object [] Flooding [] Collision with [] Sinking Floating Object [] Fire or explosion (fuel) [] Falls overboard [] Fire or explosion [] Falls in boat (Other than fuel) [] Hit by Boat or Propeller [] Fallen Skier [] Collision with Vessel [] Other (Specify)	WHAT IN YOUR OPINION CONTRIBUTED TO THE ACCIDENT (Check all applicable) [] Weather [] Alcohol use [] Excessive speed [] Drug use [] No Proper Lookout [] Fault of Hull [] Restricted Vision [] Fault of Machinery [] Overloading [] Fault of Equipment [] Improper Loading [] Hunting [] Racing [] Operator Inexperience [] Hazardous Waters [] Operator Inattention [] Other (Specify)					
PERSONAL FLOTATION DEVICES (PFD'S)			PROPERTY DAMAGE		FIRE EXTINGUISHERS			
Was the boat adequately equipped with COAST GUARD APPROVED FLOTATION DEVICES? [] Yes [] No Were they accessible? [] Yes [] No Were they serviceable? [] Yes [] No Were they used by survivors? [] Yes [] No What type? [] I, [] II, [] III, [] IV, [] V (specify) _____ Were PFD's properly used? [] Yes [] No Adjusted [] Yes [] No Sized [] Yes [] No			Was the vessel carrying NON approved flotation devices? [] Yes [] No Were they accessible? [] Yes [] No Were they used? [] Yes [] No If Yes, indicate kind.		Estimated amount This boat \$ _____ Other boat \$ _____ Other Property \$ _____		Were they used? (If yes, list Type(s) and number used.) [] Yes [] No [] NA Types:	
				DESCRIBE PROPERTY DAMAGE				
				NAME AND ADDRESS OF OWNER OF DAMAGED PROPERTY				
Include any comments of PFD's under ACCIDENT DESCRIPTION on other side of form								

If more than 3 fatalities and/or injuries, attach additional form(s)					
DECEASED					
NAME	ADDRESS	DATE OF BIRTH	WAS VICTIM? <input type="checkbox"/> Swimmer <input type="checkbox"/> Non Swimmer	DEATH CAUSED BY <input type="checkbox"/> Drowning <input type="checkbox"/> Other <input type="checkbox"/> DISAPPEARANCE	WAS PFD WORN? <input type="checkbox"/> Yes <input type="checkbox"/> No What Type?
NAME	ADDRESS	DATE OF BIRTH	WAS VICTIM? <input type="checkbox"/> Swimmer <input type="checkbox"/> Non Swimmer	DEATH CAUSED BY <input type="checkbox"/> Drowning <input type="checkbox"/> Other <input type="checkbox"/> DISAPPEARANCE	WAS PFD WORN? <input type="checkbox"/> Yes <input type="checkbox"/> No What Type?
NAME	ADDRESS	DATE OF BIRTH	WAS VICTIM? <input type="checkbox"/> Swimmer <input type="checkbox"/> Non Swimmer	DEATH CAUSED BY <input type="checkbox"/> Drowning <input type="checkbox"/> Other <input type="checkbox"/> DISAPPEARANCE	WAS PFD WORN? <input type="checkbox"/> Yes <input type="checkbox"/> No What Type?
INJURED					
NAME	ADDRESS	DATE OF BIRTH	NATURE OF INJURY	MEDICAL TREATMENT	
NAME	ADDRESS	DATE OF BIRTH	NATURE OF INJURY	MEDICAL TREATMENT	
NAME	ADDRESS	DATE OF BIRTH	NATURE OF INJURY	MEDICAL TREATMENT	
ACCIDENT DESCRIPTION					
DESCRIBE WHAT HAPPENED (Sequence of events. Include Failure of Equipment. If diagram is needed, attach separately. Continue on additional sheets if necessary. Include any information regarding the involvement of alcohol and/or drugs in causing or contributing to the accident. Include any descriptive information about the use of PFD's.)					
VESSEL NO. 2 (if more than 2 vessels, attach additional form (s))					
Name of Operator	Address			Boat Number	
Telephone Number				Boat Name	
Name of Owner	Address				
WITNESSES					
Name	Address			Telephone Number	
Name	Address			Telephone Number	
Name	Address			Telephone Number	
WITNESSES					
SIGNATURE	Address			Telephone Number	
QUALIFICATION (Check One) <input type="checkbox"/> Operator <input type="checkbox"/> Owner <input type="checkbox"/> Investigator <input type="checkbox"/> Other					Date Submitted
(do not use) - FOR REPORTING AUTHORITY REVIEW (use agency date stamp)					
Causes based on (check one) <input type="checkbox"/> This report <input type="checkbox"/> Investigation and this report <input type="checkbox"/> Investigation <input type="checkbox"/> Could not be determined		Name of Reviewing Office		Date Received	
Primary Cause of Accident		Secondary Cause of Accident		Reviewed By	

Float Plan

Pursuit recommends filling out a float plan each time you use your boat for an offshore day trip or a long cruise. Leave this information with a responsible person ashore, like a close friend or relative that you know well.

1. Name of person reporting and telephone number.

2. Description of boat.
 Type _____ Color _____ Trim _____
 Registration No. _____ Length _____
 Name _____ Make _____ Other Info _____

3. Engine type _____ H.P. _____
 No. of Engines _____ Fuel Capacity _____

4. Survival equipment: (Check as appropriate)

<input type="checkbox"/> PFDS	<input type="checkbox"/> Flares	<input type="checkbox"/> Mirror
<input type="checkbox"/> Smoke Signals	<input type="checkbox"/> Flashlight	<input type="checkbox"/> Food
<input type="checkbox"/> Paddles	<input type="checkbox"/> Water	<input type="checkbox"/> Others
<input type="checkbox"/> Anchor	<input type="checkbox"/> Raft or Dinghy	<input type="checkbox"/> EPIRB

5. Radio Yes No Type _____

6. Automobile license _____
 Type _____ Trailer License _____
 Color _____ and make of auto _____

7. Persons aboard _____
 Name _____ Age _____ Address & telephone No. _____

8. Do any of the persons aboard have a medical problem?
 Yes No If yes, what? _____

9. Trip Expectations: Leave at _____
 From _____ Going to _____
 Expect to return by _____ (time)
 and no later than _____

10. Any other pertinent info. _____

11. If not returned by _____ (time)
 call the COAST GUARD, or (Local authority) _____

12. Telephone Numbers.

Troubleshooting Guide

Problem	Cause and Solution
Control Systems	
<p>Hydraulic Steering is slow to respond and erratic.</p>	<ul style="list-style-type: none"> • Steering system is low on fluid. Fill and bleed system. • Steering system has air in it. Fill and bleed system. • A component in the steering system is binding. Check and adjust or repair binding component. • Engine steering cylinder is binding. Grease spindle.
<p>The boat wanders and will not hold a course at cruise speeds.</p>	<ul style="list-style-type: none"> • There could be air in the steering system. Fill & bleed the system. • The engine steering tab is corroded or out of adjustment. Replace or adjust steering tab. • Engine steering cylinder is binding. Grease spindle.
<p>The engine will not start with the shift control lever in neutral.</p>	<ul style="list-style-type: none"> • The control cable is out of adjustment & not activating the neutral safety cut out switch. • The shift control lever is not in the neutral detent. Try moving the shift lever slightly. • There is a loose wire on the neutral safety switch on the transmission. Inspect wires and repair loose connections. • The starter or ignition switch is bad.
Performance Problems	
<p>Boat is sluggish and has lost speed and RPM.</p>	<ul style="list-style-type: none"> • The boat may be need to have marine growth cleaned from hull and running gear. • Propeller may be damaged & need repair. • Weeds or line around the propeller. Clean propeller. • Boat is overloaded. Reduce load. • Check for excessive water in the bilge. Pump out bilge & find & correct the problem. • The throttle adjustments has changed and the engine is not getting full throttle. Adjust the throttle cable.

Problem	Cause and Solution
<p>The boat vibrates at cruising speeds.</p>	<ul style="list-style-type: none"> • Propeller may be damaged and need repair. • The propeller or propeller shaft is bent. Repair or replace damaged components. • The running gear is fouled by marine growth or rope. Clean running gear. • The engine is not trimmed properly. Trim the engine.
<p>Engine Problems</p>	
<p>The engine is running too hot.</p>	<ul style="list-style-type: none"> • The engine raw water pick-up strainer up is clogged with marine growth. Clean pick-up. • The engine raw water pump impeller is worn or damaged. Repair the pump. • The engine thermostat is faulty and needs to be replaced.
<p>The engine alternator is not charging properly.</p>	<ul style="list-style-type: none"> • The battery cable is loose or corroded. Clean and tighten battery cables. • The alternator is not charging and must be replaced. • The engine battery isolator in the charging system is not working properly. Replace the isolator. • The battery is defective. Replace the battery.
<p>The engine suddenly will not operate over 2000 RPM.</p>	<ul style="list-style-type: none"> • The engine emergency system has been activated. The onboard computer has sensed a problem and has limited the RPM to protect the engine. Find & correct the problem. • The tachometer is bad and needs to be replaced.

Problem	Cause and Solution
<p>The engine is loosing RPM. The boat is not overloaded and the hull bottom and running gear are clean and in good condition.</p>	<ul style="list-style-type: none"> • The engine may be having a problem with a sticky anti-siphon valve, located in the fuel line near the fuel tank, that is restricting the fuel flow. Remove & clean or replace the anti-siphon valve. • The remote gasoline fuel filter could be dirty. Inspect and replace the fuel filter. • The primary fuel filter on the engine may be dirty. Inspect and replace the fuel filter. • The electronic engine control system on the engine is malfunctioning. Repair the engine control system. • The fuel injection system on the engine is malfunctioning. Repair the fuel injection system.
<p>Accessory Problems</p>	
<p>The livewell pump runs, but does not pump water.</p>	<ul style="list-style-type: none"> • The strainer on the intake scoop is clogged preventing the water from getting to the pump. Put the boat in reverse to clean the strainer. • There is an air lock in the system. Run the boat above 15 m.p.h. and the pick-up scoop will force the air lock past the pump and prime the system. • The thru-hull valve is not open. Open valve. • The valve in the livewell is not open. Open the valve in the livewell.
<p>The automatic float switch on the bilge pump raises but does not activate the pump.</p>	<ul style="list-style-type: none"> • The in-line fuse near the battery switch has blown. Replace the fuse. • The pump impeller is jammed by debris. Clean pump impeller housing. • The pump is defective. Replace pump.

Schematics

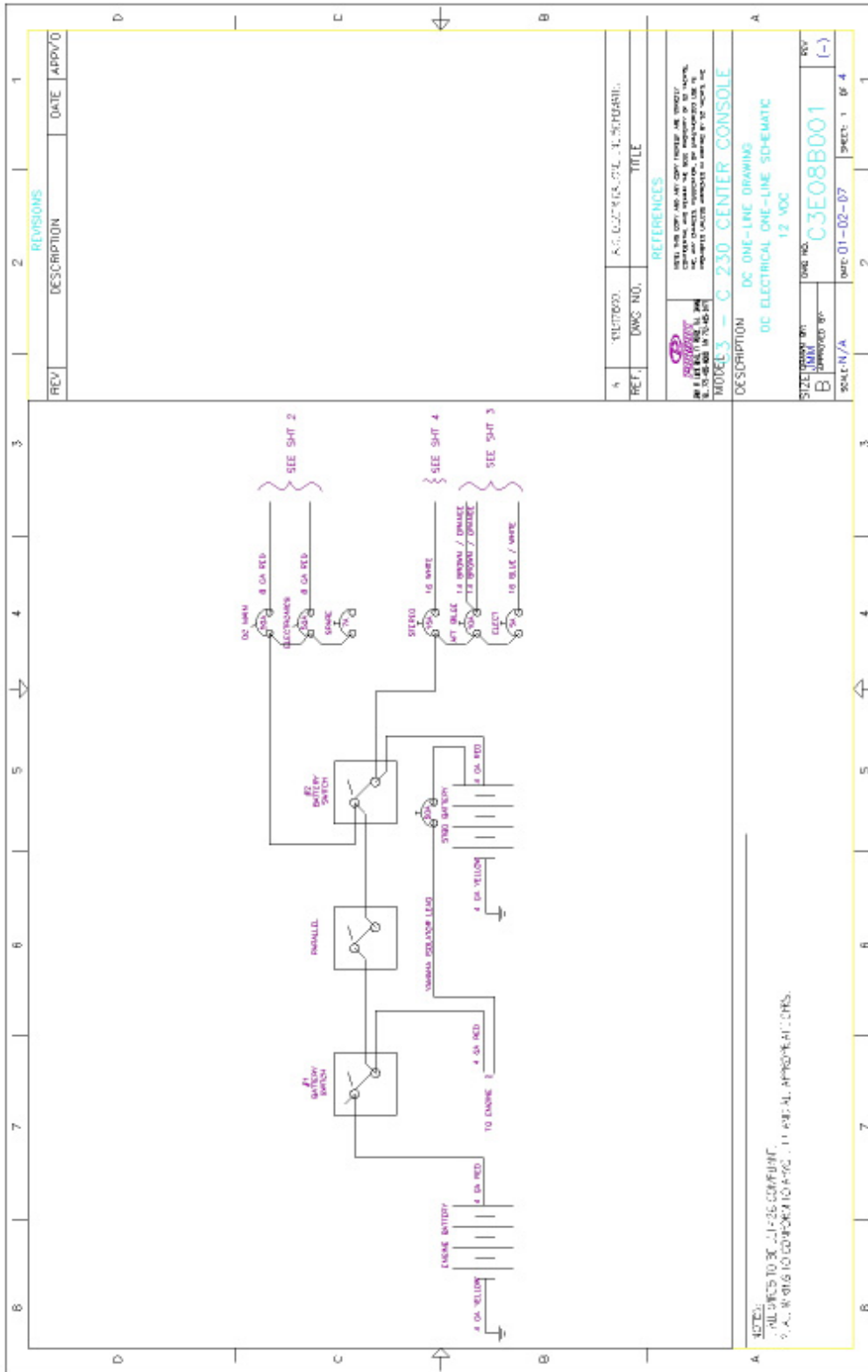

NOTES:
 1. ALL WIRING TO BE IN ACCORDANCE WITH THE WIRING MANUAL.
 2. ALL WIRING TO BE IN ACCORDANCE WITH THE WIRING MANUAL.
 3. ALL WIRING TO BE IN ACCORDANCE WITH THE WIRING MANUAL.

REV.	DESCRIPTION	DATE	APPROV'D
1			

REF.	DWG. NO.	TITLE
A	10170002	DC ELECTRICAL ONE-LINE SCHEMATIC

DESCRIPTION	DC ONE-LINE DRAWING 12 VDC
SCALE	N/A

SIZE GROUP	DATE NO.	REV.
B	C3E08B001	(-)
DATE	REV.	
01-02-07		

DISTRIBUTION			
Rev. A	Rev. B	Rev. C	Rev. D
01-02-07			

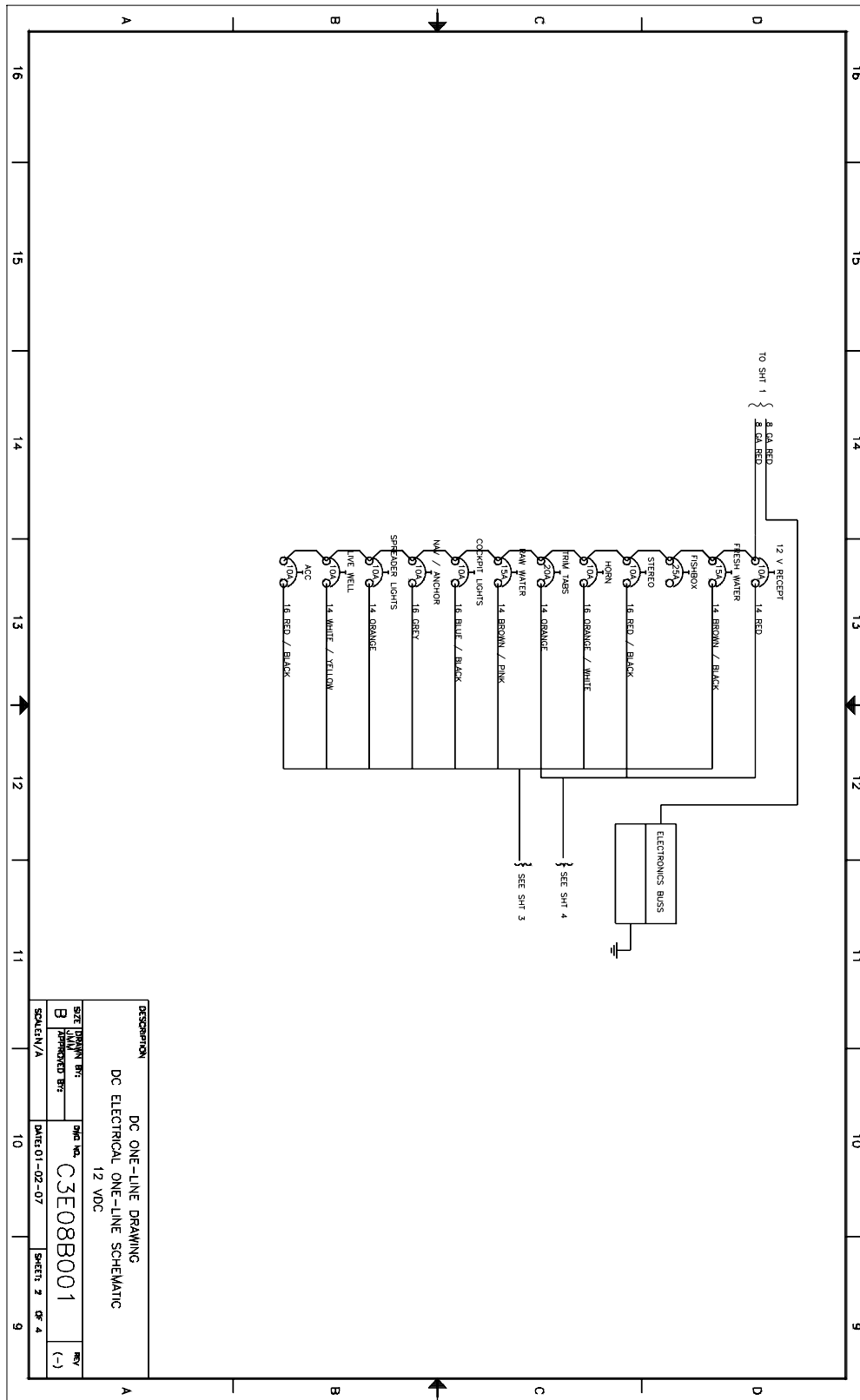

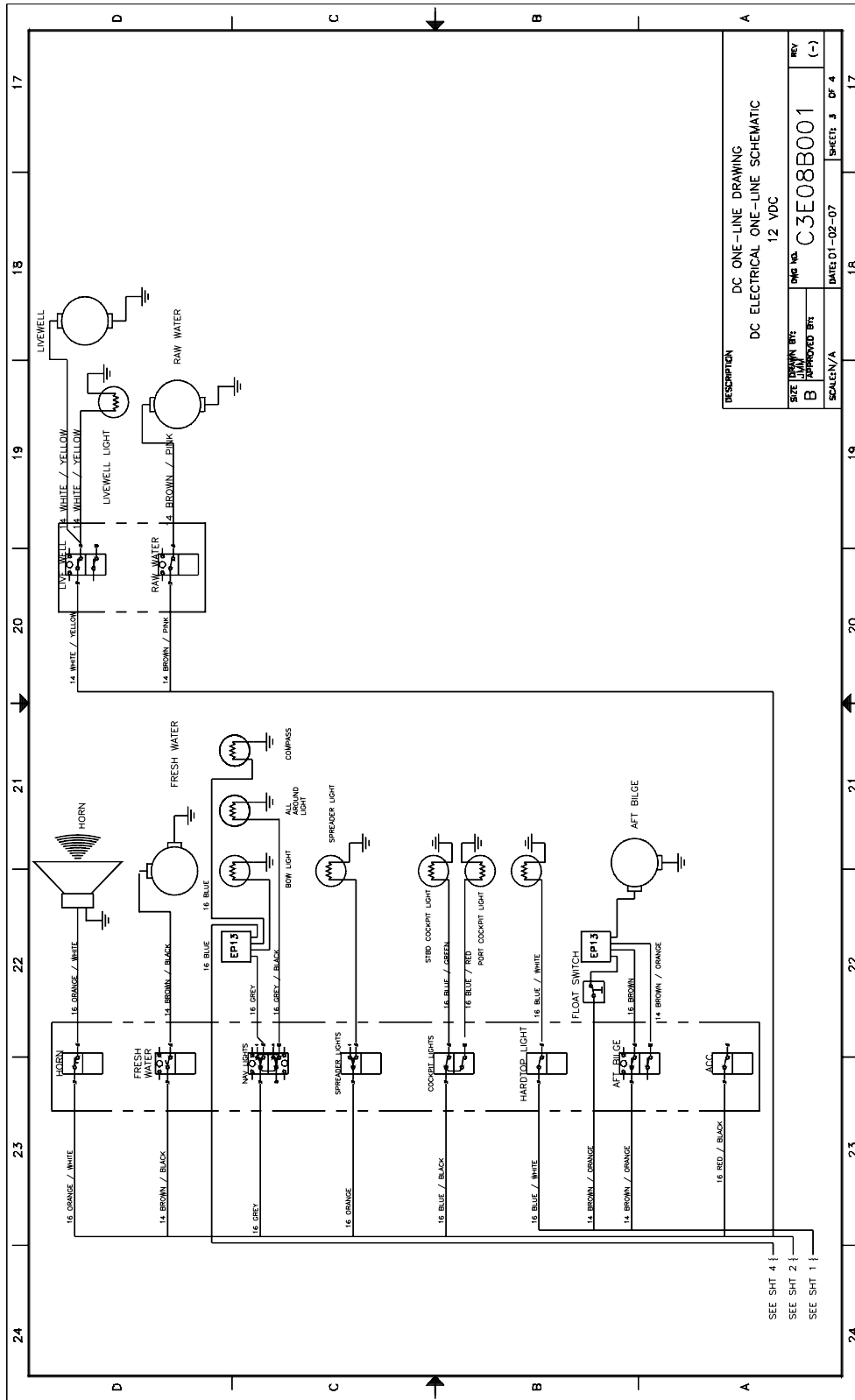

DESCRIPTION		DC ONE-LINE DRAWING	12 VDC
DC ELECTRICAL ONE-LINE SCHEMATIC			
SIZE	DRAWN BY	CHK NO.	REV
B	APPROVED BY	C3E08B001	(-)
SHEET/A	DATE	DT-02-07	SHEET 3 OF 4

PURSUIT C 230

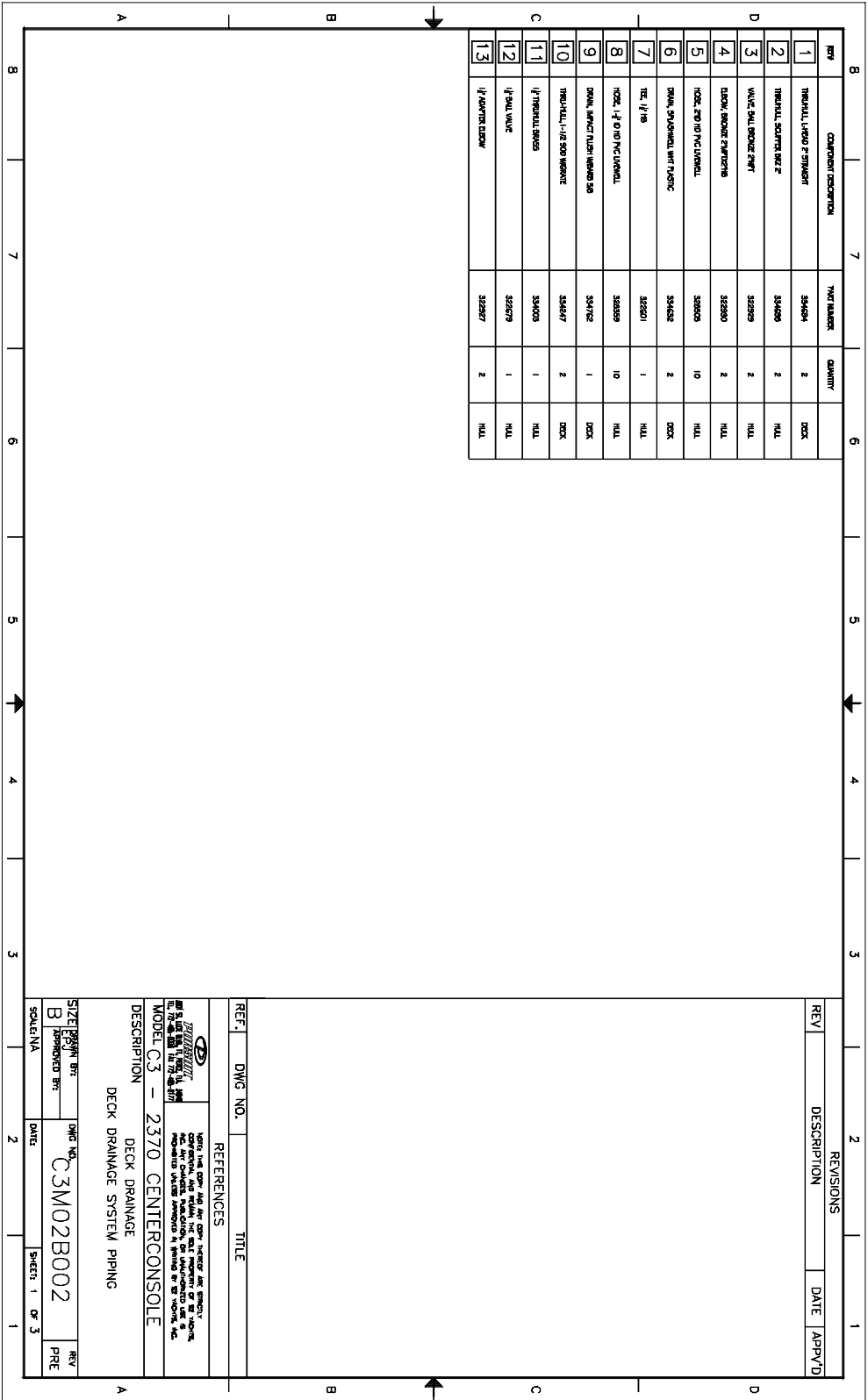

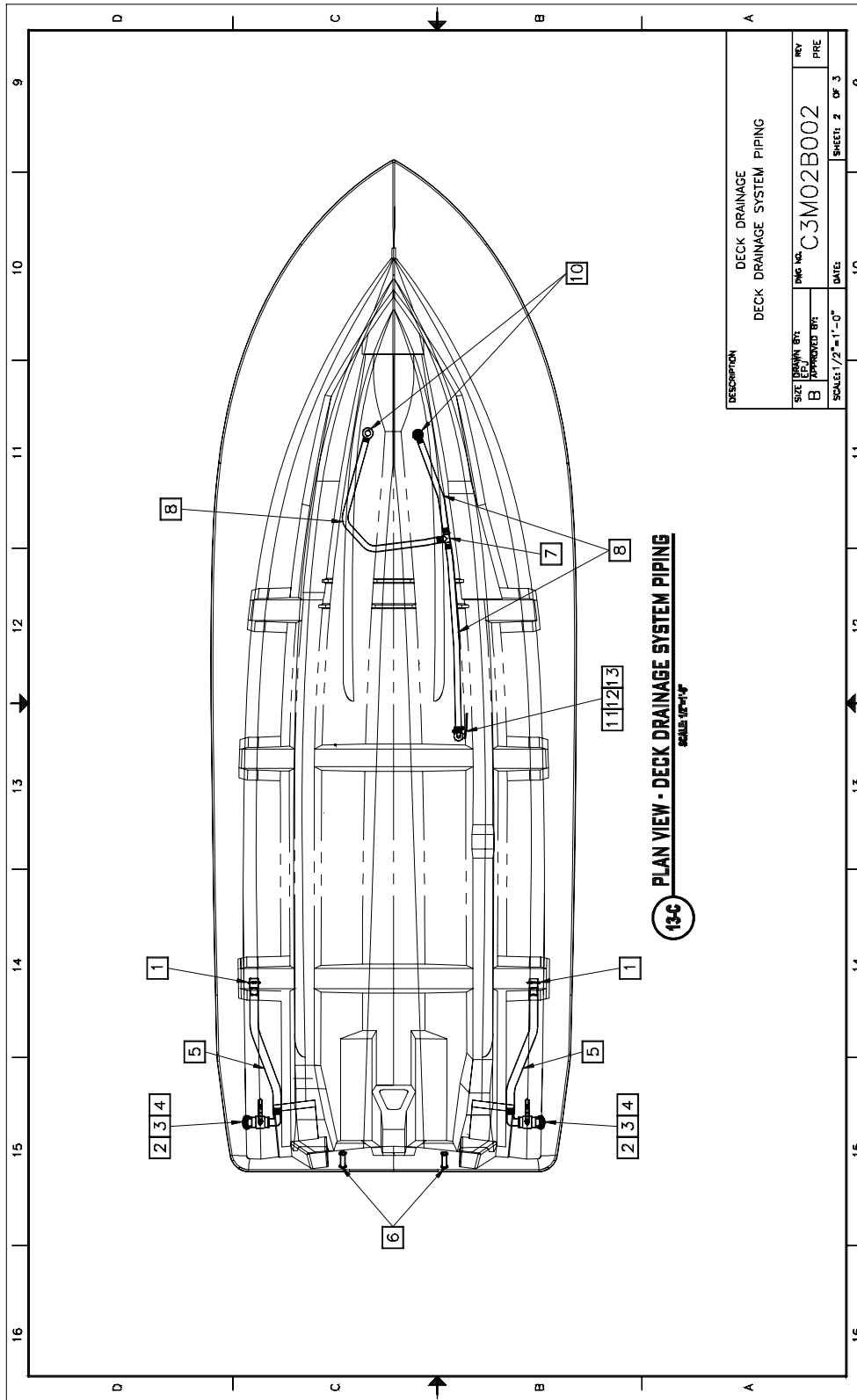

PURSUIT® C 230

