

OPERATION MANUAL



WHISPERWATT™ SERIES MODEL DCA-15SPXU4 60 Hz GENERATOR

Revision #0 (03/31/11)

**THIS MANUAL MUST ACCOMPANY
THE EQUIPMENT AT ALL TIMES.**



WARNING



CALIFORNIA — Proposition 65 Warning

Diesel engine exhaust and some of its constituents are known to the State of California to cause cancer, birth defects and other reproductive harm.

**MQ POWER DCA-15SPXU4
WHISPERWATT™ GENERATOR**

California Proposition 65 Warning 2
Table Of Contents 4
Parts Ordering Procedures 5
Specifications 6
Dimensions (Top, Side, Front) 7
Safety Message Alert Symbols 8-9
Rules for Safe Operation 10-14
Installation 16-17
General Information 18
Major Components 19
Generator Control Panel 20-21
Output Terminal Panel Familiarization 22-24
Load Application/Max Amperage 25
Gauge Reading/Terminal Panel Connections 26
Setup 27-30
Generator Start-up Procedure 31-32
Generator Shut-Down Procedure 33
Maintenance (Engine) 34-36
Maintenance (Trailer) 37-39
Generator Wiring Diagram 40
Engine Wiring Diagram 41
Troubleshooting (Engine) 42-43
Troubleshooting (Generator) 44
Troubleshooting (Pre-Heat Lamp Codes) 45

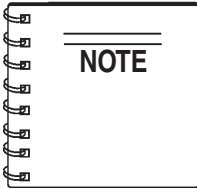

Specification and part number are subject to change without notice.

DCA-15SPXU4 — SPECIFICATIONS

Table 1. Generator Specifications

| | |
|--------------------------------|---|
| Model | DCA-15SPXU4 |
| Type | Revolving field, self ventilated, open protected type synchronous generator |
| Phase | Single Phase 3-Wire |
| Standby Output | 16.5 KW |
| Prime Output | 15 KW |
| Voltage | 240V/120 |
| Frequency | 60 Hz |
| Speed | 1800 rpm |
| Power Factor | 1.0 |
| Aux. AC Power (GFCI) | 2.4 KW @120 VAC Single Phase, 60 Hz |
| Aux. AC Power (L5-30R) | 3.6 KW@120 VAC Single Phase, 60 Hz |
| Aux. AC Power (L6-30R) | 7.2 KW@240 VAC Single Phase, 60 Hz |
| Aux. AC Power (CS6369) | 12 KW@240 VAC Single Phase, 60 Hz 6 KW@120 VAC Single Phase, 60 Hz |

Table 2. Engine Specifications

| | | |
|---------------------------|--|--|
| Model | KUBOTA V2203-M | |
| Type | 4 Cycle, water-cooled, swirl combustion chamber type | |
| No. of Cylinders | 4 cylinders | |
| Bore x Stroke | 3.43 in. x 3.64 in. (87 mm x 92.4 mm) | |
| Rated Output | 27.1 HP/1800 rpm | |
| Displacement | 134.1 cu. in. (2,197 cc) | |
| Starting | Electric | |
| Coolant Capacity | 2.09 gal. (7.9 liters) | |
| Lube Oil Capacity | 2.00 gal. (7.6 liters) | |
| Fuel Tank Capacity | 16.4 gal. (62 liters) | |
| Fuel Consumption | 1.37 gal. (5.2 L)/hr at full load | 1.08 gal. (4.08 L)/hr at 3/4 load |
| | 0.83 gal. (3.14 L)/hr at 1/2 load | 0.62 gal. (2.34 L)/hr at 1/4 load |
| Battery | 12V- 65AH (27:525A) | |
| Fuel | #2 Diesel Fuel | |
| Dry Weight | 577 kg | |
| Total Weight | 649 kg | |

DCA-15SPXU4 — DIMENSIONS (TOP, SIDE AND FRONT)

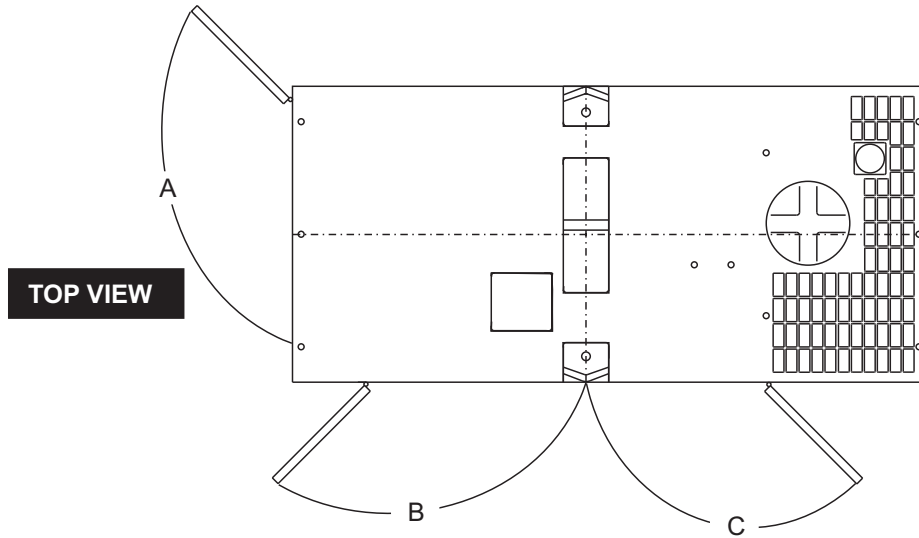
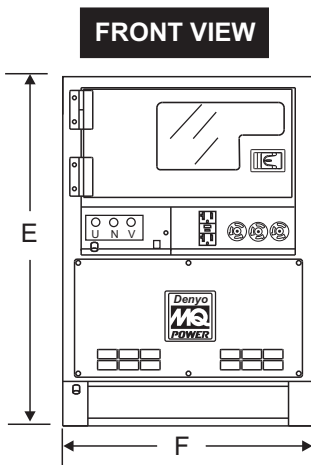
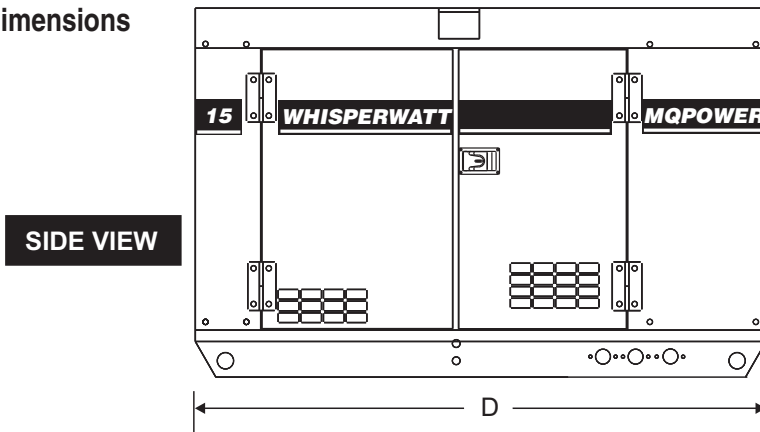

Figure 1. Dimensions



| TABLE 3. DIMENSIONS | |
|---------------------|---------------------|
| Reference Letter | Dimension in. (mm.) |
| A | 21.65 (550) |
| B | 20.07 (510) |
| C | 21.85 (555) |
| D | 61.02 (1,550) |
| E | 35.43 (900) |
| F | 25.60 (650) |

DCA-15SPXU4 — SAFETY MESSAGE ALERT SYMBOLS

FOR YOUR SAFETY AND THE SAFETY OF OTHERS!

Safety precautions should be followed at all times when operating this equipment. Failure to read and understand the Safety Messages and Operating Instructions could result in injury to yourself and others.

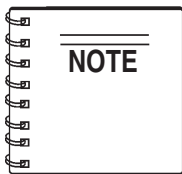

This Owner's Manual has been developed to provide complete instructions for the safe and efficient operation of the MQ Power **Model DCA-15SPXU4 Whisperwatt™ Generator**.

Before using this generator, ensure that the operating individual has read and understands all instructions in this manual.

SAFETY MESSAGE ALERT SYMBOLS

The three (3) Safety Messages shown below will inform you about potential hazards that could injure you or others. The Safety Messages specifically address the level of exposure to the operator, and are preceded by one of three words: **DANGER**, **WARNING**, or **CAUTION**.

DANGER

You **WILL** be **KILLED** or **SERIOUSLY** injured if you do not follow directions.

WARNING

You **COULD** be **KILLED** or **SERIOUSLY** injured if you do not follow directions.

CAUTION

You **CAN** be injured if you do not follow directions

HAZARD SYMBOLS

Potential hazards associated with the operation of this equipment will be referenced with "**Hazard Symbols**" which appear throughout this manual, and will be referenced in conjunction with Safety "**Message Alert Symbols**".

WARNING - LETHAL EXHAUST GASES



Gasoline engine exhaust gases contain poisonous carbon monoxide. This gas is colorless and odorless, and can cause **DEATH** if inhaled. **NEVER** operate this equipment in a confined area or enclosed structure that does not provide ample free flow air.

WARNING - EXPLOSIVE FUEL

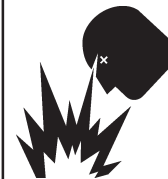

Diesel fuel is extremely flammable, and its vapors can cause an explosion if ignited. **DO NOT** start the engine near spilled fuel or combustible fluids. **DO NOT** fill the fuel tank while the engine is running or hot.

DO NOT overfill tank, since spilled fuel could ignite if it comes into contact with hot engine parts or sparks from the ignition system. Store fuel in approved containers, in well-ventilated areas and away from sparks and flames. **NEVER** use fuel as a cleaning agent.

WARNING - BURN HAZARDS



Engine components can generate extreme heat. To prevent burns, **DO NOT** touch these areas while the engine is running or immediately after operations. **NEVER** operate the engine with heat shields or heat guards removed.

DANGER - ELECTROCUTION HAZARDS

During operation of this generator, there exists the possibility of **electrocution, electrical shock or burn**, which can cause **severe bodily harm** or even **DEATH!**



DCA-15SPXU4 — SAFETY MESSAGE ALERT SYMBOLS

! WARNING - ROTATING PARTS

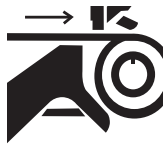

NEVER operate equipment with covers, or guards removed. Keep **fingers, hands, hair** and clothing away from all moving parts to prevent injury.

! CAUTION - RESPIRATORY HAZARDS



ALWAYS wear approved **respiratory** protection.

! CAUTION - ACCIDENTAL STARTING



ALWAYS place the **engine ON/OFF** switch (**MPEC**) in the **OFF/RESET** position when the generator is not in use.

! CAUTION - SIGHT AND HEARING HAZARDS



ALWAYS wear approved **eye** and **hearing** protection.

! CAUTION - OVER-SPEED CONDITIONS



NEVER tamper with the factory settings of the engine governor or settings. Personal injury and damage to the engine or equipment can result if operating in speed ranges above maximum allowable.

! CAUTION - EQUIPMENT DAMAGE MESSAGES

Other important messages are provided throughout this manual to help prevent damage to your generator, other property, or the surrounding environment.

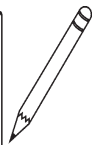
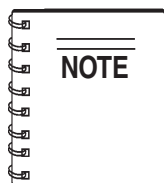

This generator, other property, or the surrounding environment could be damaged if you do not follow instructions.

! CAUTION - ENGINE LOAD (WET-STACKING)

Wet-Stacking is a common problem with diesel engines which are operated for extended periods with light or no load applied. When a diesel engine operates without sufficient load (less than 40% of the rated output) it will not operate at its optimum temperature. This will allow unburned fuel to accumulate in the exhaust system, which can foul the fuel injectors, engine valves and exhaust system, including turbochargers, and reduce the operating performance.

In order for a diesel engine to operate at peak efficiency it must be able to provide fuel and air in the proper ratio and at a high enough engine temperature for the engine to completely burn all of the fuel.

Wet stacking does usually cause any permanent damage and can be alleviated if additional load is applied to relieve the condition. It can reduce the system performance and increase maintenance. Applying an increasing load over a period of time until the excess fuel is burned off and the system capacity is reached usually can repair the condition. This can take several hours to burn off the accumulated unburned fuel.

DCA-15SPXU4 — RULES FOR SAFE OPERATION

DANGER - READ THIS MANUAL!

Failure to follow instructions in this manual may lead to **serious injury** or even **DEATH!** This equipment is to be operated by trained and qualified personnel only! This equipment is for industrial use only.

The following safety guidelines should always be used when operating the **DCA-15SPXU4 Whisperwatt™ AC Generator**.

General Safety:

- **DO NOT** operate or service this equipment before reading this entire manual.



The operator **MUST BE** familiar with proper safety precautions and operations techniques before using generator.

- This equipment should not be operated by persons under 18 years of age.
- **NEVER** operate this equipment without proper protective clothing, shatterproof glasses, steel-toed boots and other protective devices required by the job.



- **NEVER** operate this equipment when not feeling well due to fatigue, illness or taking medicine. 
- **NEVER** operate this equipment under the influence or drugs or alcohol.



- **ALWAYS** wear proper respiratory (mask), hearing and eye protection equipment when operating the generator. 
- Whenever necessary, replace nameplate, operation and safety decals when they become difficult read.
- Manufacturer does not assume responsibility for any accident due to equipment modifications. Unauthorized equipment modification will void all warranties.

- **NEVER** use accessories or attachments, which are not recommended by Multiquip for this equipment. Damage to the equipment and/or injury to user may result.

- **NEVER** touch the hot exhaust manifold, muffler or cylinder. Allow these parts to cool before servicing engine or generators.

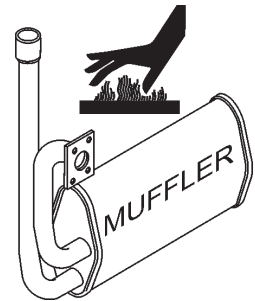

- The engine section of this generators requires an adequate free flow of cooling air. **NEVER** operate the generator in any enclosed or narrow area where free flow of the air is restricted. If the air flow is restricted it will cause serious damage to the generators or engine and may cause injury to people. Remember the generator's engine gives off **DEADLY** carbon monoxide gas.

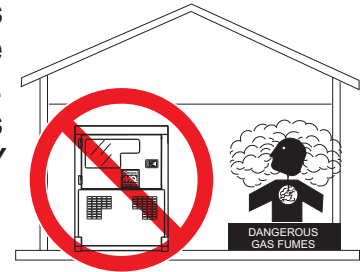

- **ALWAYS** refuel in a well-ventilated area, away from sparks and open flames.
- **ALWAYS** use extreme caution when working with **flammable** liquids. When refueling, **stop the engine** and allow it to cool. **DO NOT smoke** around or near the machine. Fire or explosion could result from fuel vapors, or if fuel is spilled on a hot engine.



- **NEVER** operate the generator in an explosive atmosphere or near combustible materials. An explosion or fire could result causing severe **bodily harm or even death**.

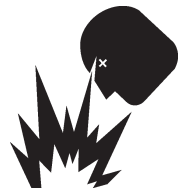

- **NEVER** disconnect any "**emergency or safety devices**". These devices are intended for operator safety. Disconnection of these devices can cause severe injury, bodily harm or even death! Disconnection of any of these devices will void all warranties.

DCA-15SPXU4 — RULES FOR SAFE OPERATION

- **ALWAYS** be sure the operator is familiar with proper safety precautions and operation techniques before using generators.
- **NEVER** leave the generator unattended, turn off engine when unattended.
- Unauthorized equipment modifications will void all warranties.
- **ALWAYS** ensure generator is on level ground before use.
- **DO NOT** place hands or fingers inside generators engine compartment when engine is running.
- **NEVER** run engine without air cleaner. Severe engine damage may occur.
- **NEVER** change or adjust the engine speed which has been set at the factory prior to shipping.

Power Cord Safety

- **NEVER** let power cables or cords *lay in water*.
- **NEVER** *stand in water* while AC power from the generators is being transfer to a load.
- **NEVER** use a defective or frayed power cable. Check the cable for cuts in the insulation.
- **NEVER** use a extension cord that is frayed or damaged where the insulation has been cut.
- **ALWAYS** make certain that proper power or extension cord has been selected for the job See Table 6.

Grounding Safety

- **ALWAYS** make sure that electrical circuits are properly *grounded* per the **National Electrical Code** (NEC) and local codes before operating generator. Severe *injury* or *death!* by electrocution can result from operating an ungrounded generator.
- **ALWAYS** make sure the generators are properly grounded to a suitable earth ground (**GROUND ROD**). See installation in this manual.
- **NEVER** use *gas piping* as an electrical ground.

Maintenance Safety

- **NEVER** lubricate components or attempt service on a running machine.
- **High Temperatures** – Always stop engine and allow the engine to cool before adding fuel, oil or performing service and maintenance functions. Contact with **hot!** components can cause serious burns. 
- Keep the machinery in proper running condition.
- Fix damage to the machine immediately and replace any broken parts immediately.
- **ALWAYS** replace any worn or damaged warning decals.
- **ALWAYS** store equipment properly when it is not being used. Equipment should be stored in a clean, dry location out of the reach of children and un-authorized personnel.
- The electrical voltage required to operate the generator can cause severe injury or even death through physical contact with live circuits. Turn all circuit breakers **OFF** before performing maintenance on the generator.
- Dispose of hazardous waste properly. Examples of potentially hazardous waste are used motor oil, fuel and fuel filters.
- **DO NOT** use food or plastic containers to dispose of hazardous waste.
- **DO NOT** pour waste, oil or fuel directly onto the ground, down a drain or into any water source.
- **ALWAYS** allow the machine a proper amount of time to cool before servicing.
- **ALWAYS** service air cleaner frequently to prevent engine malfunction.
- **ALWAYS** disconnect the **NEGATIVE battery terminal** before performing service on the generator.
- Follow all battery safety guidelines listed in this manual when handling or servicing the generator.

DCA-15SPXU4 — RULES FOR SAFE OPERATION

WARNING - BURN HAZARDS

To prevent burns, **DO NOT** touch or open any of the below mentioned components while the engine is running or immediately after operations. Always allow sufficient time for the engine and generator to cool before performing maintenance.



■ **Radiator Cap** - Removing the radiator cap while the engine is hot will result in high pressurized, boiling water to gush out of the radiator, causing severe scalding to any persons in the general area of the generator.

■ **Coolant Drain Plug** - Removing the coolant drain plug while the engine is hot will result in hot coolant gushing out of the coolant drain plug, therefore causing severe scalding to any persons in the general area of the generator.



■ **Engine Oil Drain Plug** - Removing the engine oil drain plug while the engine is hot will result in hot oil gushing out of the oil drain plug, therefore causing severe scalding to any persons in the general area of the generator.

Battery Safety

Use the following guidelines when handling the battery:

- The battery contains acids that can cause injury to the eyes and skin. To avoid eye irritation, **always** wear safety glasses.
- Use well insulated gloves when picking up the battery.

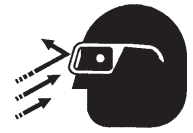

DANGER - EXPLOSION HAZARDS

The risk of an explosion exists when performing service on the battery. To avoid **severe injury** or **DEATH**:

- **DO NOT** drop the battery. There is the possibility of risk that the battery may explode.
- **DO NOT** expose the battery to open flames, sparks, cigarettes etc. The battery contains combustible gases and liquids. If these gases and liquids come in contact with a flame or spark, an explosion could occur.

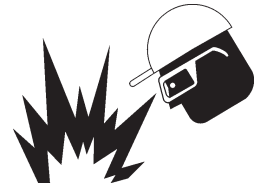

- **ALWAYS** keep the battery charged. If the battery is not charged a buildup of combustible gas will occur.
- **ALWAYS** keep battery charging and cables in good working condition. Repair or replace all worn cables.
- **ALWAYS** recharge the battery in an vented air environment, to avoid risk of a dangerous concentration of combustible gases.
- In case the battery liquid (dilute sulfuric acid) comes in contact with **clothing or skin**, rinse skin or clothing immediately with plenty of water.
- In case the battery liquid (dilute sulfuric acid) comes in contact with your **EYES**, rinse eyes immediately with plenty of water and contact the nearest doctor or hospital to seek medical attention.

DANGER-Electrocution Hazards

During operation of this generator, there exists the possibility of **electrocution, electrical shock or burn**, which can cause **severe bodily harm** or even **DEATH!**



To avoid these hazards:

NEVER use **damaged** or **worn** cables when connecting equipment to the generator. Make sure power connecting cables are securely connected to the generator's output receptacles, incorrect connections may cause damage to the generators and electrical shock.

NEVER grab or touch a live power cord with wet hands, the possibility exist of electrical shock, electrocution, and even **death!**

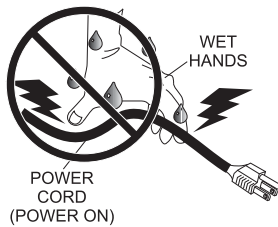

NEVER insert any objects into the output receptacles during operation. This is extremely dangerous. **ALWAYS** turn-off the generators and place all circuit breakers in the "OFF" position when contact with the output receptacles is required. There exist the possibility of **electrocution, electrical shock or burn, which can cause severe bodily harm or even death!**

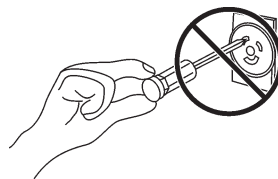

Backfeed to a utility system can cause **electrocution** and or property damage. **NEVER** connect the generators to a building's electrical system without a transfer switch or other approved device. All installations should be performed by a **licensed electrician** in accordance with all applicable laws and electrical codes. Failure to do so could result in electrical shock or burn causing serious injury or even death!



DANGER-Lethal Exhaust Gas Hazards



Engine exhaust gases contain poisonous carbon monoxide. This gas is colorless and odorless, and can cause death if inhaled. **NEVER** operate this equipment in a confined area or enclosed structure that does not provide ample free flow air.



 DANGER

Using a generator indoors **CAN KILL YOU IN MINUTES.**

Generator exhaust contains carbon monoxide. This is a poison you cannot see or smell

| | |
|--|---|
|  NEVER use inside a home or garage, even if doors and windows are open |  Only use OUTSIDE and far away from windows, doors, and vents. |
|--|---|

Avoid other generator hazards.
READ MANUAL BEFORE USE.

Emergencies

■ **ALWAYS** know the location of the nearest **fire extinguisher**.



■ **ALWAYS** know the location of the nearest **first aid kit**.



■ In emergencies **always** know the location of the nearest phone or **keep a phone on the job site**. Also know the phone numbers of the nearest **ambulance, doctor** and **fire department**. This information will be invaluable in the case of an emergency.

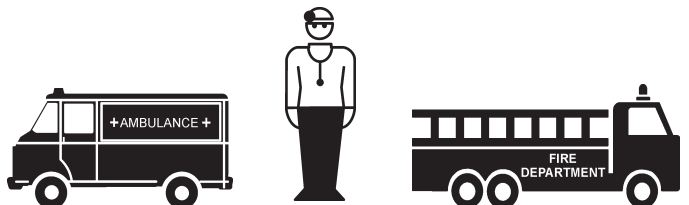

DCA-15SPXU4 — RULES FOR SAFE OPERATION



If your generator is trailer mounted, please read the towing and safety requirements listed below.

Towing and Transporting Safety

To reduce the possibility of an accident while transporting the generator on public roads, always make sure the trailer that supports the generator and the towing vehicle are in good operating condition and both units are mechanically sound.

The following list of safety precautions should be followed when towing your generator:

CAUTION - FOLLOW TOWING REGULATIONS

Check with your local county or state safety towing regulations, in addition to meeting **Department of Transportation (DOT) Safety Towing Regulations**, before towing your generator.

- **ALWAYS** shutdown engine before transporting.
- Drain fuel from generator fuel tank before towing.
- If generator is mounted on a trailer, make sure trailer complies with all local and state safety transportation laws. Follow the listed **Towing & Transporting Safety** guidelines for basic towing techniques.
- Make sure the hitch and coupling of the towing vehicle are rated equal to, or greater than the trailer "gross vehicle weight rating."
- **ALWAYS** inspect the hitch and coupling for wear. **NEVER** tow a trailer with defective hitches, couplings, chains etc.
- Check the tire air pressure on both towing vehicle and trailer. **Trailer tires should be inflated to 50 psi cold.** Also check the tire tread wear on both vehicles.
- **ALWAYS** make sure the trailer is equipped with a "Safety Chain".
- **ALWAYS** attach trailer's safety chains to towing vehicle properly.
- **ALWAYS** make sure the vehicle and trailer directional, backup, brake, and trailer lights are connected and working properly.

- DOT Requirements include the following:
 - Connect and test electric brake operation.
 - Secure portable power cables in cable tray with tie wraps.
- The maximum speed for highway towing is **55 MPH** unless posted otherwise. Recommended off-road towing is not to exceed **15 MPH** or less depending on type of terrain.
- Place **chock blocks** underneath wheel to prevent **rolling**, while parked.
- Use the trailer's swivel jack to adjust the trailer height to a level position while parked.
- Avoid sudden stops and starts. This can cause skidding, or jack-knifing. Smooth, gradual starts and stops will improve towing.
- Avoid sharp turns.
- Trailer should be adjusted to a level position at all times when towing.
- Raise and lock trailer wheel stand in up position when transporting.
- The maximum speed for highway towing is **55 MPH** unless posted otherwise. Recommended off-road towing is not to exceed **15 MPH** or less depending on type of terrain.
- Place **support blocks** underneath the trailer's bumper to prevent **tipping**, while parked.
- Avoid sharp turns to prevent rolling.
- **DO NOT** transport generator with fuel in tank.



For more safety tips, see the trailer safety guidelines section in this manual.

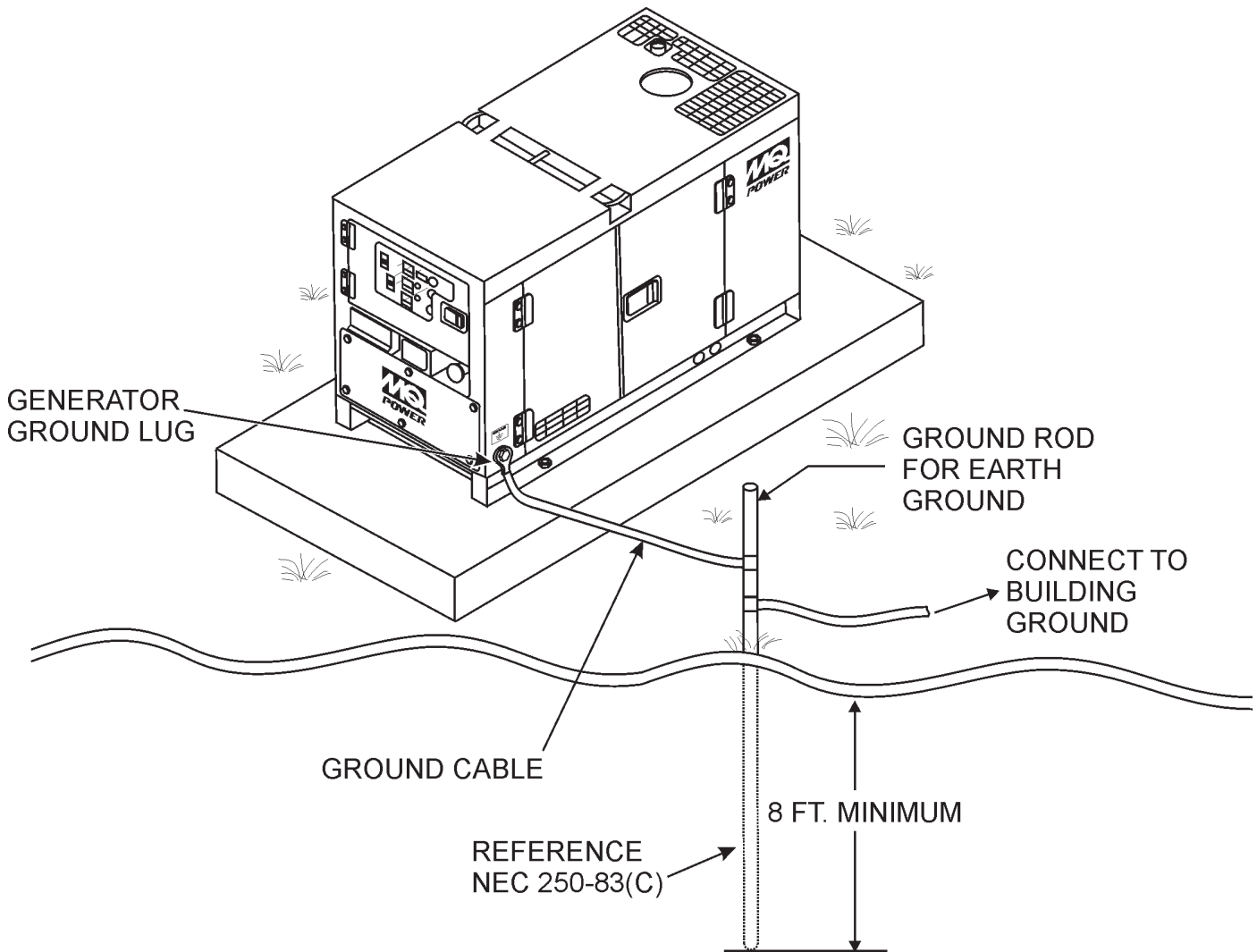

Figure 2. Typical Generator Grounding Application

Outdoor Installation

Install the generator in a area that is free of debris, bystanders, and overhead obstructions. Make sure the generator is on secure level ground so that it cannot slide or shift around. Also install the generator in a manner so that the exhaust will not be discharged in the direction of nearby homes.

The installation site must be relatively free from moisture and dust. All electrical equipment should be protected from excessive moisture. Failure to do will result in deterioration of the insulation and will result in short circuits and grounding.

Foreign materials such as dust, sand, lint and abrasive materials have a tendency to cause excessive wear to engine and alternator parts.

CAUTION - EXHAUST HAZARD

Pay close attention to ventilation when operating the generator inside tunnels and caves. The engine exhaust contains noxious elements. Engine exhaust must be routed to a ventilated area.

Indoor Installation

Exhaust gases from diesel engines are extremely poisonous. Whenever an engine is installed indoors the exhaust fumes must be vented to the outside. The engine should be installed at least two feet from any outside wall. Using an exhaust pipe which is too long or too small can cause excessive back pressure which will cause the engine to heat excessively and possibly burn the valves.

Mounting

The generator must be mounted on a solid foundation (such as concrete) and set firmly on the foundation to isolate vibration of the generator when it is running. The generator must set at least 6 inches above the floor or grade level (in accordance to NFPA 110, Chapter 5-4.1). **DO NOT** remove the metal skids on the bottom of the generator. They are to resist damage to the bottom of the generator and to maintain alignment.

Generator Grounding

To guard against electrical shock and possible damage to the equipment, it is important to provide a good **EARTH** ground.

Article 250 (Grounding) of the National Electrical Code (NEC) provides guide lines for proper grounding and specifies that the cable ground shall be connected to the grounding system of the building as close to the point of cable entry as practical.

NEC articles 250-64(b) and 250-66 set the following grounding requirements:

1. Use one of the following wire types to connect the generator to earth ground.
 - a. Copper - 10 AWG (5.3 mm²) or larger.
 - b. Aluminum - 8 AWG (8.4 mm²) or larger.
2. When grounding the generator (Figure 2) connect the ground cable between the lock washer and the nut on the generator and tighten the nut fully. Connect the other end of the ground cable to earth ground.
3. NEC article 250-52(c) specifies that the earth ground rod should be buried a minimum of 8 ft. into the ground.

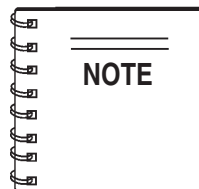

When connecting the generator to any buildings electrical system **ALWAYS** consult with a licensed electrician.

DCA-15SPXU4 Whisperwatt™ Series Familiarization

Generator

This MQ Power generator is a 15 kW **generator** (Figure 3) that is designed as a high quality portable (requires a trailer for transport) power source for telecom sites, lighting facilities, power tools, submersible pumps and other industrial and construction machinery.

Generator Control Panel

The "Engine Operating Panel" is provided with the following:

- Warning Lamp Unit
 - Preheat Lamp
 - Oil Pressure Alarm Lamp
 - Water Temperature Alarm Lamp
 - Battery Charging Alarm Lamp
- Speed Control Switch
- Frequency Meter (Hz)
- AC Ammeter (Amps)
- AC Voltmeter (Volts)
- Voltage Regulator
- Starter Switch
- Hour Meter
- 3-Pole, 70 amp Main Circuit Breaker
- 1-Pole, 20 amp Circuit Breaker (for GFCI)
- 1-Pole, 30 amp Circuit Breaker (for L5-30R)
- 2-Pole, 30 amp Circuit Breaker (for L6-30R)
- 2-Pole, 50 amp Circuit Breaker (for CS6369)
- "Control Box" (located behind the Gen. Control Panel)
 - Automatic Voltage Regulator
 - Current Transformer
 - Over-Current Relay
 - Voltage Rectifier
 - Starter Relay

Output Terminal Panel

The "Output Terminal Panel" is provided with the following:

- Three output terminal lugs (1Ø power)
- 1-Phase Output Terminal
- 120/240V output receptacle (CS-6369), 50A
- 120V output receptacle (5-20R)GFCI, 20A
- 120V output receptacle (L5-30R), 30A
- 240V output receptacle,(L6- 30R) 30A
- Ground Terminal (for G.F.C.U)
- Battery Charger (Optional)
- Water Heater (Optional)

Open Delta Excitation System

The generator is equipped with the state of the art "**Open-Delta**" excitation system. The open delta system consist of an electrically independent winding wound among stationary windings of the AC output section.

There are four connections of the open delta A, B, C and D. During steady state loads, the power from the voltage regulator is supplied from the parallel connections of A to B, A to D, and C to D. These three phases of the voltage input to the voltage regulator are then rectified and are the excitation current for the exciter section.

When a heavy load, such as a motor starting or a short circuit occurs, the automatic voltage regulator (AVR) switches the configuration of the open delta to the series connection of B to C. This has the effect of adding the voltages of each phase to provide higher excitation to the exciter section and thus better voltage response during the application of heavy loads.

The connections of the AVR to the AC output windings are for sensing only. No power is required from these windings.

The open-delta design provides virtually unlimited excitation current, offering maximum motor starting capabilities. The excitation does not have a "**fixed ceiling**" and responds according the demands of the required load.

Engine

The **DCA-15SPXU4** is powered by a 4 cylinder, water cooled, **Kubota Model V2203-M diesel engine**. This engine is designed to meet every performance requirement for the generator. Reference Table 1 for engine specifications.

In keeping with MQ Power's policy of constantly improving its products, the specifications quoted herein are subject to change without prior notice.

Electric Governor System

The electric governor system controls the RPMs of the engine. When the engine demand increases or decreases, the governor system regulates the frequency variation to $\pm 0.25\%$.

Extension Cables

When electric power is to be provided to various tools or loads at some distance from the generator, extension cords are normally used. Cables should be sized to allow for distance in length and amperage so that the voltage drop between the generator and point of use (load) is held to a minimum. Use the cable selection chart (Table 6) as a guide for selecting proper extension cable size.

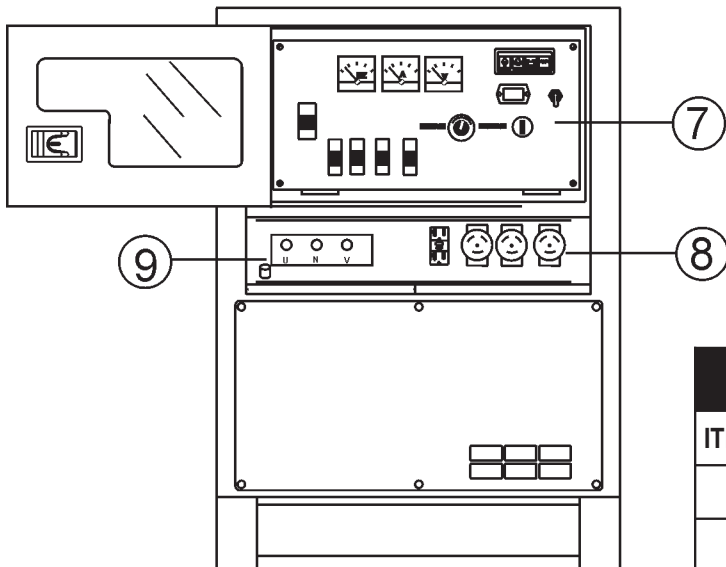
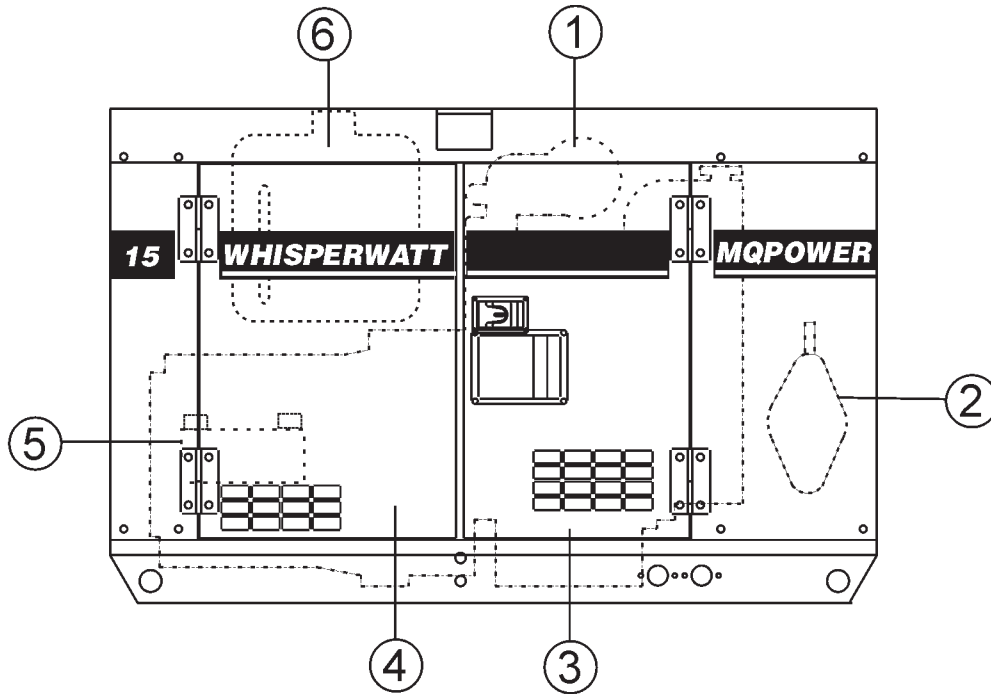

Figure 3. Major Components

Table 4. Generator Major Components

| ITEM NO. | DESCRIPTION |
|----------|----------------------------------|
| 1 | Air Filter Assembly |
| 2 | Muffler Assembly |
| 3 | Engine and Radiator Assembly |
| 4 | Generator Assembly |
| 5 | Battery Assembly |
| 6 | Fuel Tank Assembly |
| 7 | Generator Control Panel Assembly |
| 8 | Output Receptacle Assembly |
| 9 | Output Terminal Assembly |

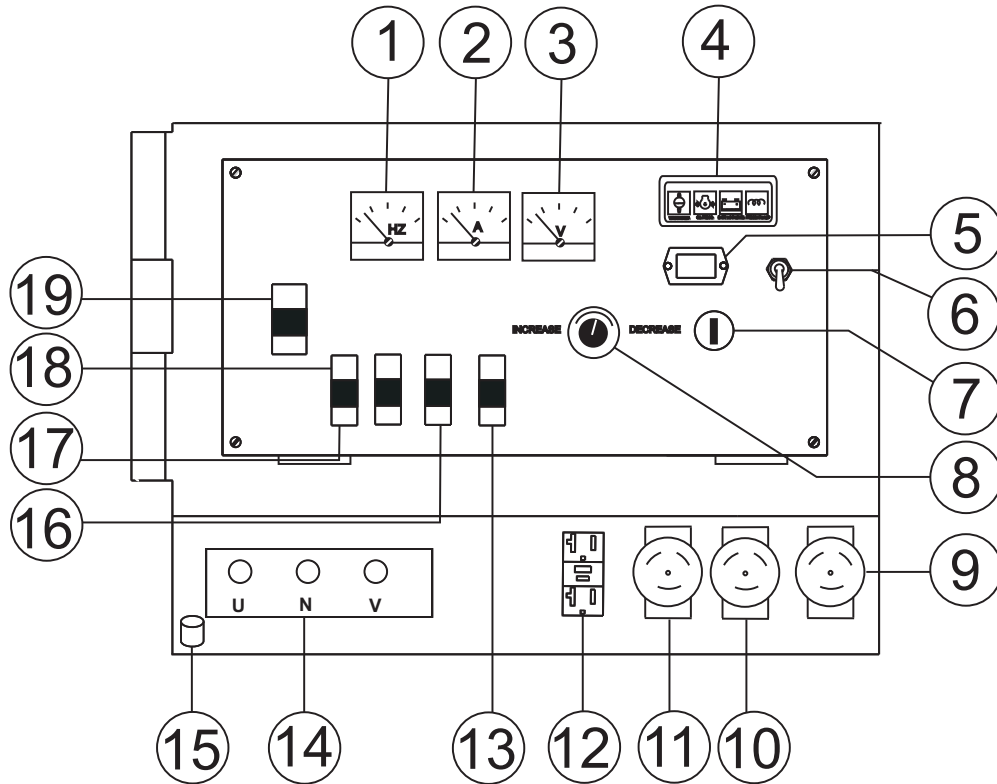

Figure 4. Generator Control Panel

DCA-15SPXU4 — GENERATOR CONTROL PANEL

The definitions below describe the controls and functions of the **Generator Control Panel** (Figure 4).

1. **Frequency Meter** – Indicates the output frequency in hertz (Hz). Normally 60 Hz.
2. **AC Ammeter** – Indicates the amount of current the load is drawing from the generator per leg selected by the ammeter phase-selector switch.
3. **AC Voltmeter** – Indicates the output voltage present at the **U, O, and V Output Terminal Lugs**.
4. **Engine Warning Lamp Module** – This module displays the following engine failures:
 - A. **Pre-Heat Lamp** – As the engine cranks, this lamp will illuminate to indicate automatic preheating of the engine. When the lamp turns off, the engine has been preheated.
 - B. **Water Temperature Alarm Lamp** – This lamp indicates when the emergency shutdown system has stopped the engine for abnormally high water temperature(234 deg. F).
 - C. **Oil Pressure Alarm Lamp** – This lamp is on when the starter switch is in the “ON” position and the engine oil pressure is low(7.1 PSI). It will indicate when the starter switch is in the “ON” position, before the engine has been started, and if the emergency shutdown system has stopped the engine.
 - D. **Battery Charging Alarm Lamp** – This lamp is ON when the output voltage of the alternator drops to an unusual value. If this lamp indicates during operation, the emergency shutdown system immediately operates to stop the engine.
5. **Hour Meter** – Indicates the number of hours machine has been in use.
6. **Engine Speed Control Switch** – This switch controls the speed of the engine from **idle** to **high**.
7. **Starter Switch** – This switch has four positions.
 - A. **Stop** – The switch should be in this position anytime the unit is not in operation. This position allows removal of the key.
 - B. **Run** – The switch should be in this position when the unit is in operation.
 - C. **Preheat** – Use this position before starting during cold weather operating conditions. Observe the Preheat Lamp for indication of the proper time for starting the engine.
 - D. **Start** – This position starts the engine, and when released will automatically return to the run position.
8. **Voltage Regulator Control** – Allows $\pm 15\%$ manual adjustment of the generator’s output voltage.
9. **CS6369 Receptacle** – Provides 240/120 VAC output (50 amps max).
10. **L6-30R Receptacle** – Provides 240 VAC output (30 amps max).
11. **L5-30R Receptacle** – Provides 120 VAC output (30 amps max).
12. **GFCI Receptacle** – Provides 120 VAC output (20 amps max).
13. **AC Circuit Breaker** - This two-pole, 50A breaker is provided to protect the CS6369 receptacle from overload.
14. **UNV Terminals** - Connect load to these terminals AC load for 120/240 VAC single phase 60 Hz. output.
15. **GFCI Ground Terminal** - Use this terminal to ground the generator
16. **AC Circuit Breaker** - This two-pole, 30A breaker is provided to protect the auxillary receptacle (for L6-30R) from overload.
17. **AC Circuit Breaker** - This single-pole, 30A breaker is provided to protect the auxillary receptacle (for L5-30R) from overload.
18. **AC Circuit Breaker** - This single-pole, 20A GFCI breaker is provided to protect the GFCI receptacle (5-20R) from overload.
19. **AC Circuit Breaker** – This three-pole, 70A main breaker is provided to protect the the **U, N, and V Output Terminal Lugs** from overload.

DCA-15SPXU4 — OUTPUT TERMINAL PANEL FAMILIARIZATION

Output Terminal Panel

The **Output Terminal Panel** (Figure 5) shown below is located on the right-hand side (left from control panel) of the generator. Lift up on the cover to gain access to receptacles and terminal lugs.

Output Terminal Familiarization

The “**Output Terminal Panel**” (Figure 5) is provided with the following:

- CS6369 receptacle 125/240V @ 50 amps
- Circuit Breaker @ 50 amps (CS6369 receptacle)
- 120V GFCI receptacle @ 20 amps
- L5-30R receptacle, 125V @ 30 amps
- L6-30R receptacle, 240V @ 30 amps
- Three Output Terminal Lugs (U, N, V and Ground)

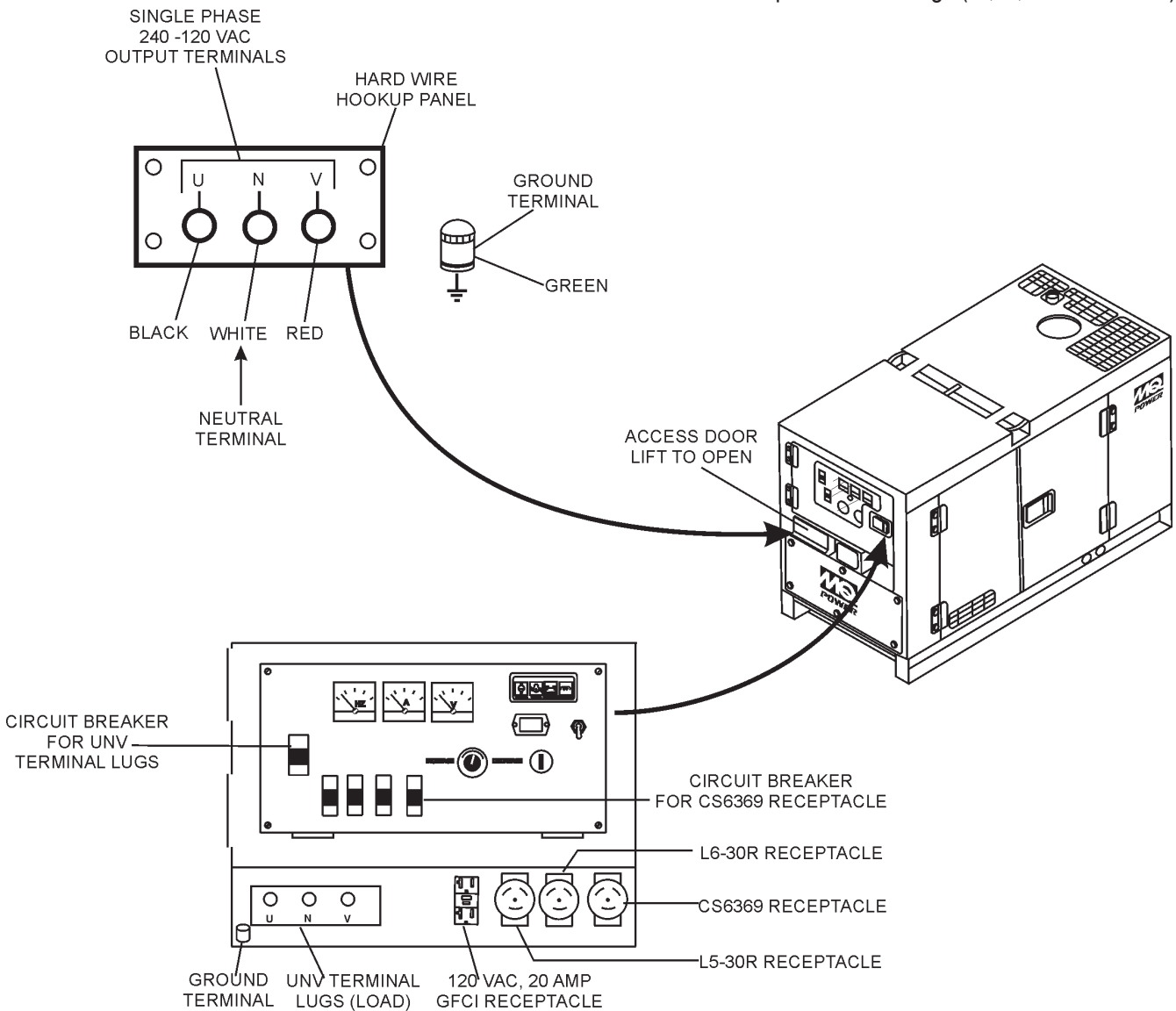

Figure 5. Output Terminal Panel

DCA-15SPXU4 — OUTPUT TERMINAL PANEL FAMILIARIZATION

120 VAC GFCI Receptacle

This 120 VAC, 20 amp GFCI (Duplex Nema 5-20R) receptacle can be used anytime the generator is in operation. Remember the load output (current) of the GFCI receptacle is dependent on the load requirements of the U, N, and V output terminal lugs.

Pressing the **reset** button resets the GFCI receptacle after being tripped. Pressing the **Test Button** (See Figure 6) in the center of the receptacle will check the GFCI function. Both receptacles should be tested at least once a month.

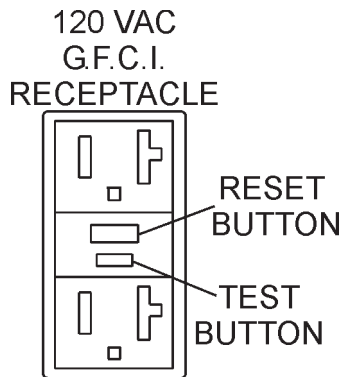

Figure 6. G.F.C.I. Receptacle

Twist Lock Dual Voltage 120/240 VAC Receptacle (Option)

There is one CS-6369 120/240V, 50 amp auxiliary twist-lock receptacle (Figure 7) provided on the output terminal panel. This receptacle is protected by a 50 amp circuit breaker.

CS-6369
TWIST-LOCK
RECEPTACLE



SINGLE-PHASE
120/240 VAC
50 AMP OUTPUT

Figure 7. 120/240V CS6369 Twist-Lock Auxiliary Receptacle

L5-30R Twist Lock 120 VAC Receptacle

There is one L5-30R, 120 VAC 30 amp auxiliary twist-lock receptacle (Figure 8) provided on the output terminal panel.

L5-30R
TWIST-LOCK
RECEPTACLE



SINGLE-PHASE
120 VAC
30 AMP OUTPUT

Figure 8. 120 VAC L5-30R Twist-Lock Auxiliary Receptacle

L6-30R Twist Lock 240 VAC Receptacle (Option)

There is one L6-30R, 240 VAC 30 amp auxiliary twist-lock receptacle (Figure 9) provided on the output terminal panel.

L6-30R
TWIST-LOCK
RECEPTACLE



SINGLE-PHASE
240 VAC
30 AMP OUTPUT

Figure 9. 240 VAC L6-30R Twist-Lock Auxiliary Receptacle

Turn the **voltage regulator control knob** (Figure 10) on the control panel to obtain the desired voltage. Turning the knob clockwise will **increase** the voltage, turning the knob counter-clockwise will **decrease** the voltage.



Figure 10. Voltage Regulator Control Knob

DCA-15SPXU4 — OUTPUT TERMINAL PANEL FAMILIARIZATION

Connecting Loads

Loads can be connected to the generator by the **Output Terminal Lugs** or the convenience receptacles (Figure 11). Make sure to read the operation manual before attempting to connect a load to the generator.

To protect the output terminals from overload, a 3-pole, 70A **main** circuit breaker is provided. Make sure to switch **ALL** circuit breakers to the **OFF** position prior to starting the engine.

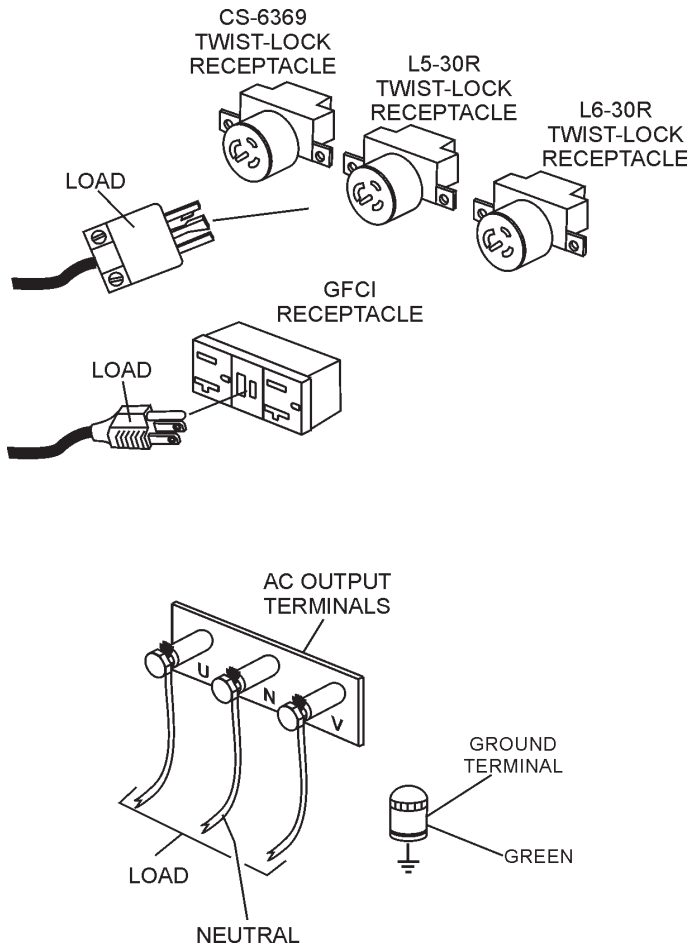

Figure 11. Connecting Loads

DCA-15SPXU4 — LOAD APPLICATION/MAXIMUM AMPERAGE

Single Phase Load

Always be sure to check the nameplate on the generator and equipment to insure the wattage, amperage, frequency, and voltage requirements are satisfactorily supplied by the generator for operating the equipment.

Generally, the wattage listed on the nameplate of the equipment is its rated output. Equipment may require 130—150% more wattage than the rating on the nameplate, as the wattage is influenced by the efficiency, power factor and starting system of the equipment.

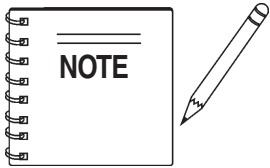

If wattage is not given on the equipment's name plate, approximate wattage may be determined by multiplying nameplate voltage by the nameplate amperage.

$$\text{WATTS} = \text{VOLTAGE} \times \text{AMPERAGE}$$

The power factor of this generator is 0.8. See Table 5 below when connecting loads.

Table 5. Power Factor By Load

| Type Of Load | Power Factor |
|---|--------------|
| Single-phase induction motors | 0.4 - 0.75 |
| Electric heaters, incandescent lamps | 1.0 |
| Fluorescent lamps, mercury lamps | 0.4 - 0.9 |
| Electronic devices, communication equipment | 1.0 |
| Common power tools | 0.8 |

Table 6. Cable Selection (60 Hz, Single Phase Operation)

| Current in Amperes | Load In Watts | | Maximum Allowable Cable Length | | | |
|--------------------|---------------|--------------|--------------------------------|----------|----------|----------|
| | At 100 Volts | At 200 Volts | #10 Wire | #12 Wire | #14 Wire | #16 Wire |
| 2.5 | 300 | 600 | 1000 ft. | 600 ft. | 375 ft. | 250 ft. |
| 5 | 600 | 1200 | 500 ft. | 300 ft. | 200 ft. | 125 ft. |
| 7.5 | 900 | 1800 | 350 ft. | 200 ft. | 125 ft. | 100 ft. |
| 10 | 1200 | 2400 | 250 ft. | 150 ft. | 100 ft. | |
| 15 | 1800 | 3600 | 150 ft. | 100 ft. | 65 ft. | |
| 20 | 2400 | 4800 | 125 ft. | 75 ft. | 50 ft. | |

CAUTION: Equipment damage can result from low voltage.

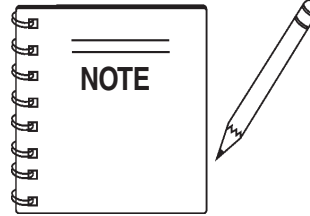

Motors and motor-driven equipment draw much greater current for starting than during operation.

An inadequate size connecting cable which cannot carry the required load can cause a voltage drop which can burn out the appliance or tool and overheat the cable. See Table 6.

- When connecting a resistance load such as an incandescent lamp or electric heater, a capacity of up to the generating set's rated output (kW) can be used.
- When connecting a fluorescent or mercury lamp, a capacity of up to the generating set's rated output (kW) multiplied by 0.6 can be used.
- When connecting an electric drill or other power tools, pay close attention to the required starting current capacity.

When connecting ordinary power tools, a capacity of up to the generating set's rated output (kW) multiplied by 0.8 can be used.

DANGER - ELECTRICAL SYSTEM HAZARDS

Before connecting this generator to any building's electrical system, a **licensed electrician** must install an **isolation (transfer) switch**. Serious damage to the building's electrical system may occur without this transfer switch.

Generator Amperage

Table 7 describes the generator's current output capability.

Table 7. Generator Maximum Amps

| Rated Voltage | Maximum Amps |
|-----------------------|---------------|
| Single Phase 120 Volt | 62.5 X 2 amps |
| Single Phase 240 Volt | 62.5 amps |

DCA-15SPXU4 — GAUGE READING/TERMINAL PANEL CONNECTIONS

UNV Terminal Output Voltages

240/120V output voltages can be obtained using the **Output Terminal Lugs**. Use the voltage regulator (VR) to either increase or decrease the selected voltage.

1Ø 120 Output Terminal Lug Voltages

1. Connect the load wires to the **Output Terminal Lugs** as shown in (Figure 12)

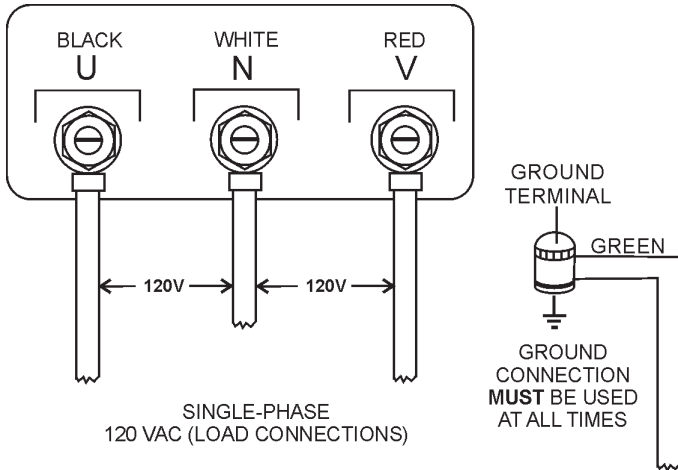

**Figure 12. Output Terminal Lugs
120 VAC Single Phase Connections**

2. Turn the voltage regulator knob (Figure 13) clockwise to increase voltage output, turn counterclockwise to decrease voltage output.



Figure 13. Voltage Regulator Knob (139V/240V)

3. Observe that the output voltage either increases or decreases by monitoring the voltmeter (Figure 14) reading.

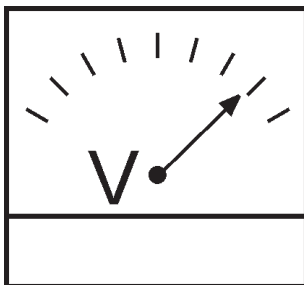

Figure 14. AC Voltmeter

Ammeter Gauge.

The ammeter gauge (Figure 15) on the generator control panel has been provided to help observe how much current (amps) is being supplied to the load from the **output terminal lugs**, GFCI receptacle or any auxilliary receptacles if installed.

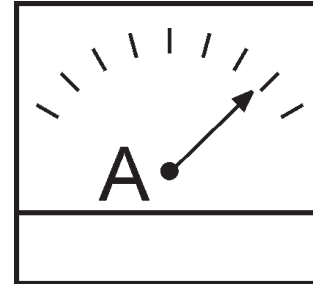
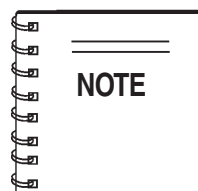

Figure 15. AC Ammeter



The **ammeter** gauge will only show a reading when the **Output Terminal Lugs** or auxilliary receptacles are connected to a load.

1Ø 240 Output Terminal Lug Voltages

1. Connect the load wires to the **Output Terminal Lugs** as shown in (Figure 16)

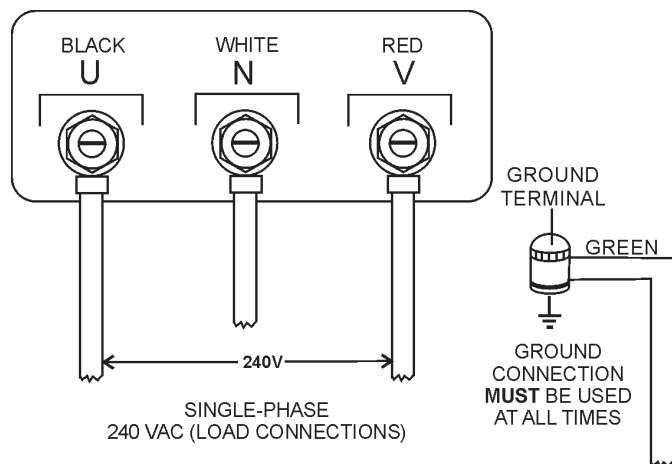

**Figure 16. Output Terminal Lugs
240 VAC Single Phase Connections**

2. Turn the voltage regulator knob (Figure 13) clockwise to increase voltage output, turn counterclockwise to decrease voltage output.

Circuit Breakers

To protect the generator from an overload, a 3-pole, 70 amp, **main** circuit breaker is provided to protect the **U,N,and V OUTPUT TERMINALS** from overload.. In addition a two-pole, 50 amp **CS6369** circuit breaker is provided to protect the CS6369 receptacle from overload. Make sure to switch **ALL** circuit breakers to the **OFF** position prior to starting the engine.

Lubrication Oil

Fill the engine crankcase with lubricating oil through the filler hole, but **DO NOT** overfill. Make sure the generator is level. and verify that the oil level is maintained between the two notches (Figure 17) on the dipstick. See Table 8 for proper selection of engine oil.

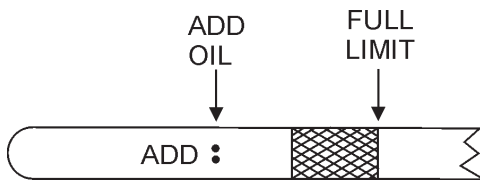

Figure 17. Engine Oil Dipstick

When checking the engine oil, be sure to check if the oil is clean. If the oil is not clean, drain the oil by removing the oil drain plug, and refill with the specified amount of oil as outlined in the **Isuzu Engine Owner's Manual**. Oil should be warm before draining.

Other types of motor oils may be substituted if they meet the following requirements:

- API Service Classification CC/SC
- API Service Classification CC/SD
- API Service Classification CC/SE
- API Service Classification CC/SF

| Table 8. Recommended Motor Oil | | OIL: SAE | |
|--------------------------------|-----|------------|-------|
| °F | °C | | |
| 122 | 50 | | |
| 104 | 40 | 10W40 | 30 |
| 86 | 30 | | |
| 68 | 20 | | |
| 50 | 10 | | |
| 32 | 0 | | |
| -14 | -10 | | |
| -4 | -20 | | |
| -22 | -30 | ARCTIC OIL | 5W30 |
| -40 | -40 | | |
| | | | 10W40 |
| | | | 15W30 |
| | | | 10W30 |
| | | | 10W |
| | | | 20W40 |

Fuel Check

! DANGER - EXPLOSION/FIRE HAZARDS

Fuel spillage on a **hot** engine can cause a **fire** or **explosion**. If fuel spillage occurs, wipe up the spilled fuel completely to prevent fire hazards. **NEVER** smoke around or near the generator.

Refilling the Fuel System

! CAUTION - REFUELING THE GENERATOR

ONLY properly trained personnel who have read and understand this section should refill the fuel tank system.

This generator has an internal fuel tank located inside the trailer frame and may also be equipped with an optional environmental fuel tank (Figure 18). **ALWAYS** fill the fuel tanks with clean fresh **#2 diesel fuel**. **DO NOT** fill the fuel tanks beyond their capacities.

Pay attention to the fuel tank capacity when replenishing fuel. The fuel tank cap must be closed tightly after filling. Handle fuel in a safety container. If the container does not have a spout, use a funnel. Wipe up any spilled fuel immediately.

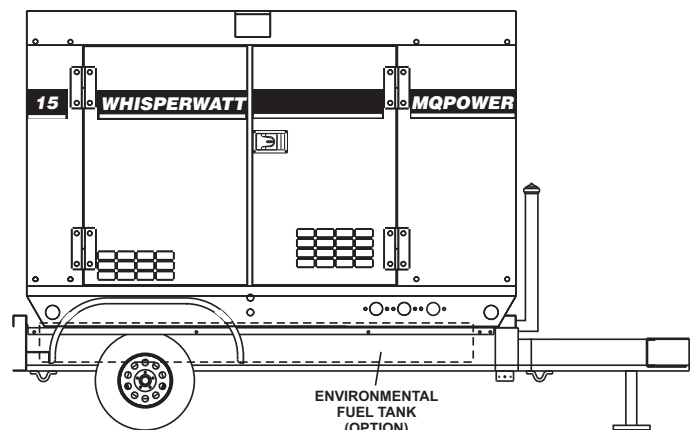

Figure 18. Internal Fuel Tank System

Refueling Procedure:

! WARNING - RESPIRATORY HAZARDS

Diesel fuel and its vapors are dangerous to your health and the surrounding environment. Avoid skin contact and/or inhaling fumes.



1. **Level Tanks** – Make sure fuel cells are level with the ground. Failure to do so will cause fuel to spill from the tank before reaching full capacity (Figure 19).

! CAUTION - REFUELING THE GENERATOR

ALWAYS place trailer on firm level ground before refueling to prevent spilling and maximize the amount of fuel that can be pumped into the tank.

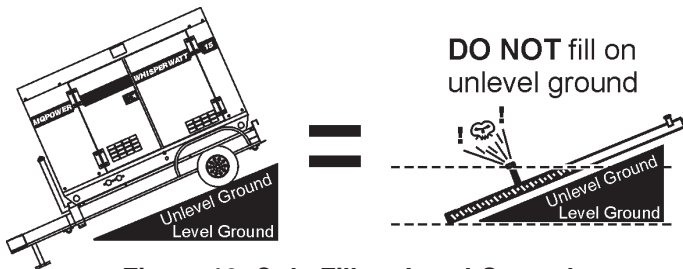
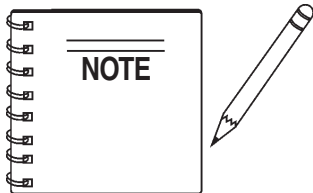

Figure 19. Only Fill on Level Ground



ONLY! use **#2 diesel fuel** when refueling.

2. Remove fuel cap (internal fuel tank) and fill fuel tank as shown Figure 20.

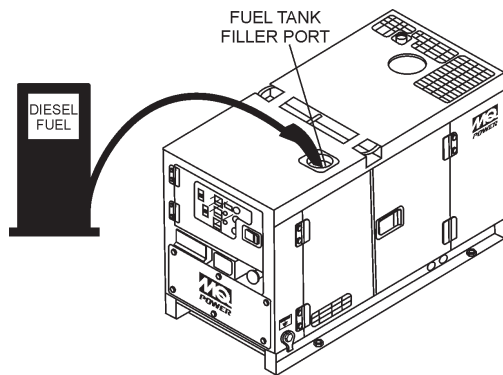
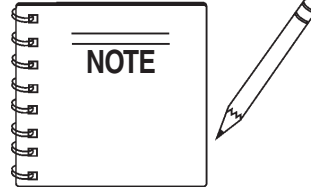

Figure 20. Fueling the Generator



If generator is equipped with an environmental fuel tank, reference Figures 21 and 22.

3. **NEVER overfill fuel tank** – It is important to read the fuel gauge when filling trailer fuel tank. **DO NOT** wait for fuel to rise in filler neck (Figure 21).

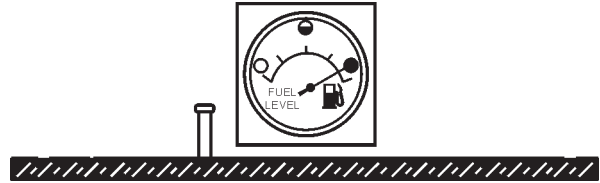

Figure 21. Full Fuel Tank

! CAUTION - REFUELING THE GENERATOR

DO NOT OVER-FILL fuel system. Leave room for fuel expansion. Fuel expands when heated (Figure 22).



Figure 22. Fuel Expansion

Coolant (Antifreeze/Summer Coolant/Water)

KUBOTA recommends antifreeze/summer coolant for use in their engines, which can be purchased in concentrate (and mixed with 50% demineralized water) or pre-diluted. See the **KUBOTA Engine Owner's Manual** for further details.

! WARNING - BURN HAZARDS

If adding coolant/antifreeze mix to the radiator, **DO NOT** remove the radiator cap until the unit has completely cooled. The possibility of **hot!** coolant exists which can cause severe burns.



Day-to-day addition of coolant is done from the recovery tank. When adding coolant to the radiator, **DO NOT** remove the radiator cap until the unit has completely cooled. See Table 9 for engine, radiator, and recovery tank coolant capacities. Make sure the coolant level in the recovery tank is always between the "H" and the "L" markings.

| Component | Capacity |
|---------------------|------------------------|
| Engine and Radiator | 2.09 Gal. (7.9 liters) |
| Reserve Tank | .264 Gal (1.0 liters) |

Operation Freezing Weather

When operating in freezing weather, be certain the proper amount of antifreeze (Table 10) has been added.

| Vol % Anti-Freeze | Freezing Point | |
|----------------------|----------------|-----|
| | °C | °F |
| 50 | -37 | -34 |

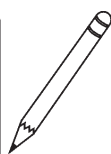
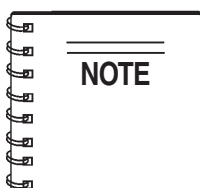

When the antifreeze is mixed with water, the antifreeze mixing ratio **must be** less than 50%.

Cleaning the Radiator

The engine may overheat if the radiator fins become overloaded with dust or debris. Periodically clean the radiator fins with compressed air. Cleaning inside the machine is dangerous, so clean only with the engine turned off and the **negative** battery terminal disconnected.

Air Cleaner

Periodic cleaning/replacement is necessary. Inspect it in accordance with the **KUBOTA Engine Owner's Manual**.

Fan Belt Tension

A slack fan belt may contribute to overheating, or to insufficient charging of the battery. Inspect the fan belt for damage and wear and adjust it in accordance with the **KUBOTA Engine Owner's Manual**.

The fan belt tension is proper if the fan belt bends 10 to 15 mm (Figure 23) when depressed with the thumb as shown below.

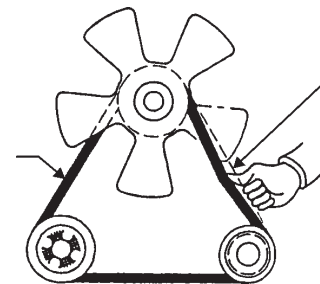



Figure 23. Fan Belt Tension

! CAUTION - ROTATING PARTS



NEVER place hands near the belts or fan while the generator set is running.



Battery

This unit is of negative ground **DO NOT** connect in reverse. Always maintain battery fluid level between the specified marks. Battery life will be shortened, if the fluid level are not properly maintained. Add only distilled water when replenishment is necessary.

DO NOT over fill. Check to see whether the battery cables are loose. Poor contact may result in poor starting or malfunctions. **Always** keep the terminals firmly tightened. Coating the terminals with an approved battery terminal treatment compound. Replace battery with only recommended type battery.

The battery is sufficiently charged if the specific gravity of the battery fluid is 1.28 (at 68° F). If the specific gravity should fall to 1.245 or lower, it indicates that the battery is dead and needs to be recharged or replaced.

Before charging the battery with an external electric source, be sure to disconnect the battery cables.

Battery Cable Installation

ALWAYS be sure the battery cables (Figure 24) are properly connected to the battery terminals as shown below. The **Red Cable** is connected to the positive terminal of the battery, and the **Black Cable** is connected to the negative terminal of the battery.

! CAUTION - BATTERY SERVICING SAFETY

ALWAYS disconnect the negative terminal **FIRST** and reconnect negative terminal **LAST**.

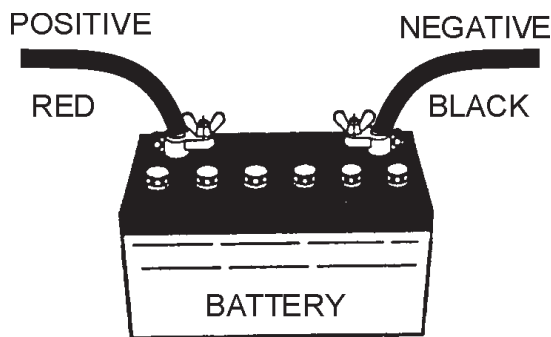
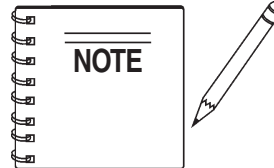

Figure 24. Battery Connections

When connecting battery do the following:

1. **NEVER** connect the battery cables to the battery terminals when the ignition switch is in the **ON** position
2. Place a small amount of battery terminal treatment compound around both battery terminals. This will ensure a good connection and will help prevent corrosion around the battery terminals.



If the battery cable is connected incorrectly, electrical damage to the generator will occur. Pay close attention to the polarity of the battery when connecting the battery.

! CAUTION - BATTERY SERVICING SAFETY

Inadequate battery connections may cause poor starting of the generator, and create other malfunctions.

Alternator

The polarity of the alternator is negative grounding type. When an inverted circuit connection takes place, the circuit will be in short circuit instantaneously resulting the alternator failure.

DO NOT put water directly on the alternator. Entry of water into the alternator can cause corrosion and damage the alternator.

Wiring

Inspect the entire generator for bad or worn electrical wiring or connections. If any wiring or connections are exposed (insulation missing) replace wiring immediately.

Piping and Hose Connection

Inspect all piping, oil hose, and fuel hose connections for wear and tightness. Tighten all hose clamps and check hoses for leaks.

If any hose (**fuel** or **oil**) lines are defective replace them immediately.

DCA-15SPXU4 — GENERATOR START-UP PROCEDURE

Before Starting

⚠ CAUTION - LETHAL EXHAUST HAZARD

The engine's exhaust contains harmful emissions. **ALWAYS have adequate ventilation when operating.** Direct exhaust away from nearby personnel.

⚠ WARNING - STARTING THE GENERATOR

NEVER! manually start the engine with the **main, GFCI** or **auxiliary** circuit breakers in the **ON** (closed) position.

- Place the **main, G.F.C.I.**, and **aux.** circuit breakers (Figure 25) in the **OFF** position prior to starting the engine.

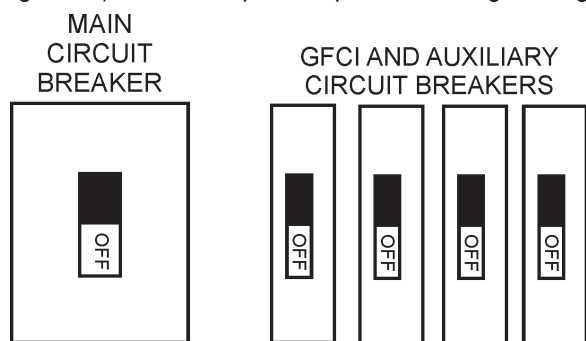

Figure 25. Main, GFCI, and Auxiliary Circuit Breakers (OFF)

- Connect the load to the **receptacles** or the **output terminal lugs** as shown in Figure 11. These load connection points can be found on the output terminal panel and the output terminal panel's hard wire hookup panel.
- Tighten terminal nuts securely to prevent load wires from slipping out.
- Close all engine enclosure doors (Figure 26).

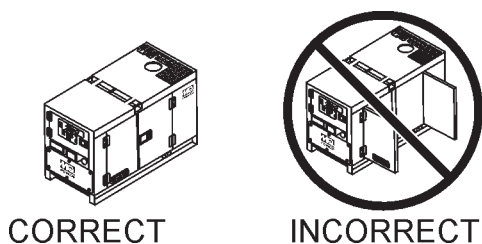

Figure 26. Engine Enclosure Doors

Start-up Procedure

- Set the Speed Control Switch to the **START/IDLE** position (Figure 27).

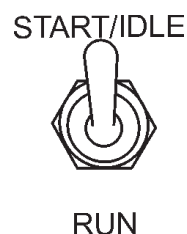

Figure 27. Speed Control Switch (START/IDLE)

- Insert the ignition key into the ignition switch. Turn the key clockwise to the **PRE-HEAT** position (Figure 28A) and observe the **Pre-Heat Lamp**. When the **Pre-Heat Lamp** has turned off, continue turning the ignition key clockwise to the **START** position (Figure 28B). When the engine starts, release the key. If engine fails to start within 10 seconds, wait 30 seconds and repeat this step.

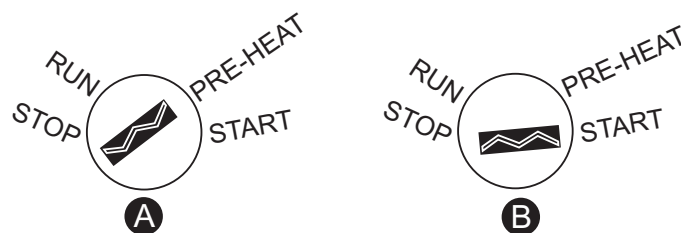

Figure 28. Ignition Switch

- Once the engine starts, let it engine run for 1-2 minutes. Listen for any abnormal noises. If any abnormalities exists shutdown the engine and correct the problem.
- The generator's frequency meter (Figure 29) should be displaying the 60 cycle output frequency in **HERTZ**.

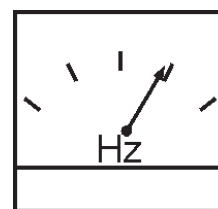

Figure 29. Frequency Meter (Hz)

DCA-15SPXU4 — GENERATOR START-UP PROCEDURE

- Set the Speed Control Switch to the **RUN** position (Figure 30).
- Place the *main*, *GFCI*, and *aux.* circuit breakers in the **ON** position (Figure 34).

START/IDLE



Figure 30. Speed Control Switch (RUN)

- The ammeter (Figure 31) will indicate **zero amps** with no load applied. When a load is applied, the ammeter will indicate the amount of current that the load is drawing from the generator.

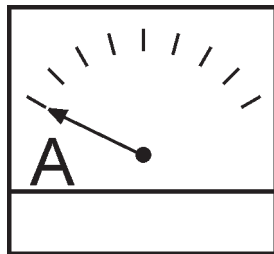

Figure 31. Ammeter (No Load)

- The generator's AC-voltmeter (Figure 32) will display the generator's output in **VOLTS**. If the voltage is not within the specified tolerance, use the voltage adjustment control knob (Figure 33) to increase or decrease the desired voltage.

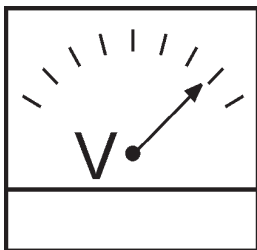

Figure 32. Voltmeter



Figure 33. Voltage Adjust Control Knob

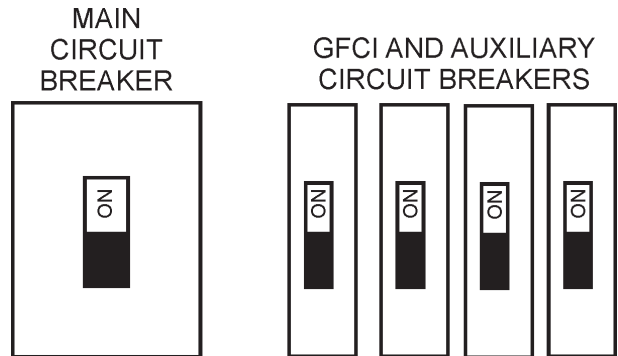

Figure 34. Main, GFCI, and Aux. Circuit Breakers (ON)

- Observe the generator's ammeter (Figure 35) and verify it reads the anticipated amount of current with respect to the load. The ammeter will only display a current reading if a load is in use.

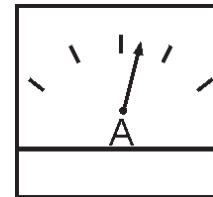

Figure 35. Ammeter (Load)

- The generator will run until manually stopped or an abnormal condition occurs.

DCA-15SPXU4 — GENERATOR SHUT-DOWN PROCEDURES



WARNING - SHUTTING DOWN THE GENERATOR

NEVER stop the engine suddenly except in an emergency.

Normal Shutdown Procedure

To shutdown the generator use the following procedure:

1. Place both the **main**, **GFCI**, and **aux.** circuit breakers as shown in Figure 25 to the **OFF** position.
2. Set the Speed Control Switch to the **START/IDLE** position as shown in Figure 27 and let the engine cool for 3-5 minutes with no load applied.
3. Turn the ignition key counter-clockwise to the **STOP** position. When the engine has stopped, remove key. Place key in a safe place where it will not be lost.
4. Inspect entire generator for any damage or loosening of components that may have occurred during operation.

Emergency Shutdown Procedure

1. Turn the ignition key counter-clockwise to the **STOP** position. When the engine has stopped, remove key. Place key in a safe place where it will not be lost.
2. Place both the **main**, **GFCI**, and **aux.** circuit breakers as shown in Figure 25 to the **OFF** position.

| TABLE 11. INSPECTION/MAINTENANCE | | 10 Hrs DAILY | 250 Hrs | 500 Hrs | 1000 Hrs |
|----------------------------------|---|-----------------|---------|---------|----------|
| ENGINE | Check Engine Fluid Levels | X | | | |
| | Check Air Cleaner | X | | | |
| | Check Battery Acid Level | X | | | |
| | Check Fan Belt Condition | X | | | |
| | Check for Leaks | X | | | |
| | Check for Loosening of Parts | X | | | |
| | Replace Engine Oil and Filter * 1 | | X | | |
| | Clean Air Filter | | X | | |
| | Check Fuel Filter/Water Separator Bowl | X | | | |
| | Clean Unit, Inside and Outside | | X | | |
| | Change Fuel Filter | | | X | |
| | Clean Radiator and Check Coolant Protection Level*2 | | | X | |
| | Replace Air Filter Element * 3 | | | X | |
| | Check all Hoses and Clamps * 4 | | | | X |
| | Clean Inside of Fuel Tank | | | | X |
| GENERATOR | Measure Insulation Resistance Over 3M ohms | | X | | |
| | Check Rotor Rear Support Bearing | | | X | |

*1 Replace engine oil and filter at 100 hours, first time only.

*2 Add "Supplemental Coolant Additives (SCA'S)" to recharge the engine coolant.

*3 Replace primary air filter element when restriction indicator shows a vacuum of 625 mm (25 in. H₂O).

*4 If blowby hose needs to be replaced, ensure that the slope of the blowby hose is at least a 1/2 inch per foot, with no sags or dips that could collect moisture and/or oil.

General Inspection

Prior to each use, the generator should be cleaned and inspected for deficiencies. Check for loose, missing or damaged nuts, bolts or other fasteners. Also check for fuel, oil, and coolant leaks. Use Table 11 as a general engine maintenance guideline (Refer to the Engine Instruction Manual).

Air Cleaner

Every 250 hours: Remove air cleaner element and clean the heavy duty paper element with light spray of compressed air. Replace the air cleaner as needed.

Air Cleaner with Dust Indicator (If Equipped)

This indicator is attached to the air cleaner. When the air cleaner element is clogged, air intake restriction becomes greater and the dust indicator signal shows **RED** meaning the element needs changing or service. After changing the air element, press the dust indicator button to reset the indicator.

Service Daily

If the engine is operating in very **dusty** or **dry grass** conditions, a clogged air cleaner will result. This can lead to a loss of power, excessive carbon buildup in the combustion chamber and high fuel consumption. Change air cleaner more **frequently** if these conditions exist.

Fuel Addition

Add diesel fuel (the grade may vary according to season and locations).

Removing Water from the Fuel Tank

After prolonged use, water and other impurities accumulate in the bottom of the tank. Occasionally inspect the fuel tank for water contamination and drain the contents if required.

During cold weather, the more empty volume inside the tank, the easier it is for water to condense. This can be reduced by keeping the tank full with diesel fuel.

Air Removal

If air enters the fuel injection system of a diesel engine, starting becomes impossible. After running out of fuel, or after disassembling the fuel system, bleed the system according to the following procedure. See the **KUBOTA Engine Manual** for details.

To restart after running out of fuel, turn the switch to the “ON” position for 15-30 seconds. Try again, if needed. This unit is equipped with an automatic air bleeding system.

Check Oil Level

Check the crankcase oil level prior to each use, or when the fuel tank is filled. Insufficient oil may cause severe damage to the engine. Make sure the generator is level. The oil level must be between the two notches on the dipstick as shown in Figure 17.

Replacing Oil Filter

- Remove the old oil filter.
- Apply a film of oil to the gasket on the new oil filter.
- Install the new oil filter.
- After the oil cartridge has been replaced, the engine oil will drop slightly. Run the engine for a while and check for leaks before adding more oil if needed. Clean excessive oil from engine.

Cleaning the Fuel Strainer

Clean the fuel strainer if it contains dust or water. Remove dust or water in the strainer cap and wash it in gasoline. Securely fasten the fuel strainer cap so that fuel will not leak. Check the fuel strainer every 200 hours of operation or once a month.

Replacing Fuel Filter

- Replace the fuel filter cartridge with new one every 500 hours or so.
- Loosen the drain plug at the lower top of the fuel filter. Drain the fuel in the fuel body together with the mixed water. **DO NOT** spill the fuel during disassembly.
- Vent any air.

Flushing Out Radiator and Replacing Coolant

- Open both cocks located at the crankcase side and at the lower part of the radiator and drain coolant. Open the radiator cap while draining. Remove the overflow tank and drain.
- Check hoses for softening and kinks. Check clamps for signs of leakage.
- Flush the radiator by running clean tap water through radiator until signs of rust and dirt are removed. **DO NOT** clean radiator core with any objects, such as a screwdriver.
- Tighten both cocks and replace the overflow tank.
- Replace with coolant as recommended by the engine manufacturer.
- Close radiator cap tightly.

WARNING - BURN HAZARDS

Allow engine to **cool** when flushing out radiator. Flushing the radiator while hot could cause serious burns from water or steam.



Generator Storage

For long term storage of the generator the following is recommended:

- Fill the fuel tank completely. Treat with a fuel stabilizer if necessary.
- Completely drain the oil from the crankcase and refill if necessary with fresh oil.
- Clean the entire generator, internal and external.
- Cover the generating set and store in a clean, dry place.
- Disconnect the battery.
- Make sure engine coolant is at proper level.
- If generator is mounted on a trailer, jack trailer up and place on blocks so tires do not touch the ground or block and completely remove the tires.

Jacket Water Heater and Internal Battery Charger 120 VAC Input Receptacles (OPTIONAL)

This generator can be optionally equipped with two 120 VAC, 20 amp input receptacles located on the output terminal panel.

The purpose of these receptacles is to provide power via commercial power to the **jacket water heater** and **internal battery charger**.

These receptacles will **ONLY** function when commercial power has been supplied to them (Figure 36). To apply commercial power to these receptacles, a power cord of adequate size will be required (See Table 6).

When using the generator in **hot** climates there is no reason to apply power to jacket water heater. However, if the generator will be used in **cold** climates it is always a good idea to apply power to the jacket water heater at all times. To apply power to the jacket water heater simply apply power to the jacket water heater receptacle via commercial power using an power cord of adequate size.

If the generator will be used daily, the battery should normally not require charging. If the generator will be idle (not used) for long periods of time, apply power to the battery charger receptacle via commercial power using an power cord of adequate size.

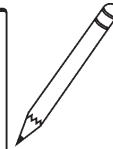
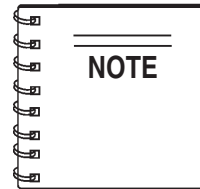

To ensure adequate starting capability, **always** have power applied to the generator's **internal battery charger**.

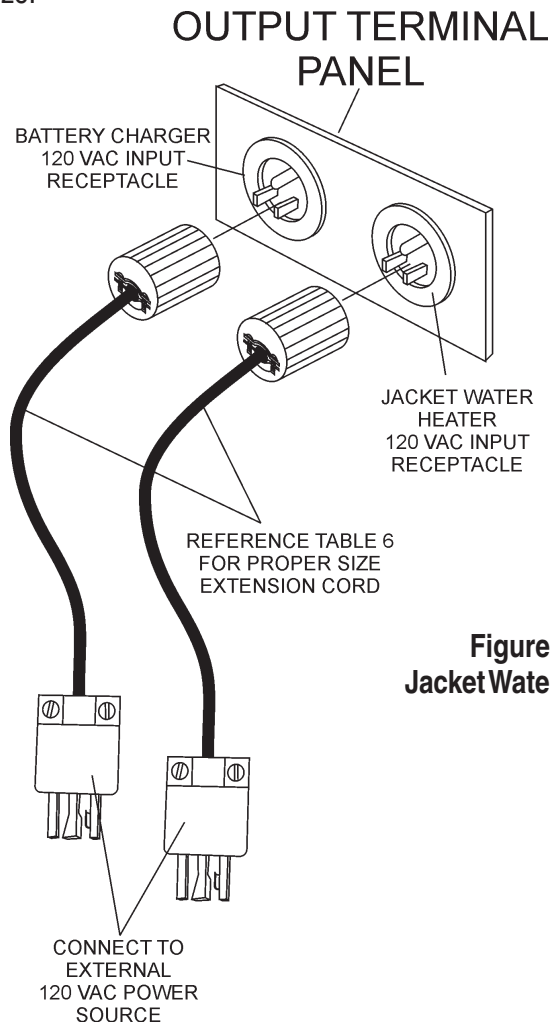

Figure 36. Battery Charger & Jacket Water Heater Power Connections

Brakes

Trailer brakes should be inspected the **first 200 miles** of operation. This will allow the brake shoes and drums to seat properly. After the first 200 mile interval, inspect the brakes **every 3,000 miles**. If driving over rough terrain, inspect the brakes more frequently.

Figure 37 displays the major hydraulic surge brake components that will require inspection and maintenance. Please inspect these components as required using steps 1 through 8 and Table 12 as listed below:

Brake Adjustment

1. Place the trailer on jack stands. Make sure the jack stands are placed on secure level ground.
2. Check the wheel and drum for free rotation.
3. Remove the adjusting hole cover from the adjusting slot at the bottom brake backing plate.
4. With a screwdriver or standard adjusting tool, rotate the star wheel of the adjuster assembly to expand the brake shoes.
5. Adjust the brake shoes outward until the pressure of the lining against the wheel drum makes the wheel difficult to turn.
6. Adjust, rotate the star wheel in the opposite direction until the wheel rotates freely with slight lining drag.
7. Replace the adjusting hole cover and lower the trailer to the ground.
8. Repeat steps 1 through 7 on the remaining brakes.

Hydraulic Surge Brakes

Hydraulic surge brakes (Figure 37) should not require any special attention with the exception of routine maintenance such as shoe and lining replacement. Brake lines should be periodically checked for cracks, kinks, or blockage.

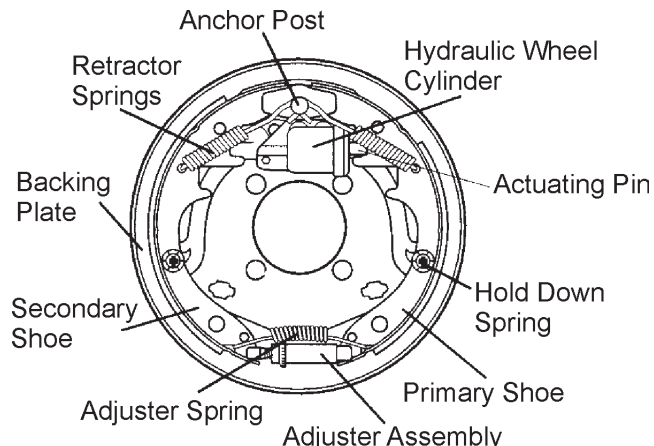

Figure 37. Hydraulic Brake Components

Actuator

Hydraulic surge braking requires the installation of an actuator at the tongue of the trailer. Remember the **surge** or **push** of the trailer toward the tow vehicle automatically synchronizes the trailer brakes with the tow vehicle brakes. As the trailer pushes against the tow vehicle the actuator telescopes together and applies force to the master cylinder, supplying hydraulic pressure to the trailer brakes.

Periodically check and test the surge “**actuator**” to make sure that it is functioning correctly. Never use an undersize actuator.

Table 12. Hydraulic Brake Troubleshooting

| Symptom | Possible Cause | Solution |
|--|---|---|
| No Brakes | Brake line broken or kinked? | Repair or replace. |
| Weak Brakes or Brakes Pull to One Side | Brake lining glazed? | Reburnish or replace. |
| | Trailer overloaded? | Correct weight. |
| | Brake drums scored or grooved? | Machine or replace. |
| | Tire pressure correct? | Inflate all tires equally. |
| | Tires unmatched on the same axle? | Match tires. |
| Locking Brakes | Brake components loose, bent or broken? | Replace components. |
| | Brake drums out-of-round? | Replace. |
| Noisy Brakes | System lubricated? | Lubricate. |
| | Brake components correct? | Replace and correct. |
| Dragging Brakes | Brake lining thickness incorrect or not adjusted correctly? | Install new shoes and linings. |
| | Enough brake fluid or correct fluid? | Replace rubber parts fill with dot 4 fluid. |

DCA-15SPXU4 — TRAILER MAINTENANCE

Tires/Wheels/Lug Nuts

Tires and wheels are a very important and critical components of the trailer. When specifying or replacing the trailer wheels it is important the wheels, tires, and axle are properly matched.

! CAUTION - EYESIGHT HAZARD

ALWAYS wear safety glasses when removing or installing force fitted parts. Failure to comply may result in serious injury.



! CAUTION - REPAIRING TRAILER WHEELS







DO NOT attempt to repair or modify a wheel. **DO NOT** install in inner tube to correct a leak through the rim. If the rim is cracked, the air pressure in the inner tube may cause pieces of the rim to explode (break off) with great force and cause serious eye or bodily injury.



Tire Wear/Inflation

Tire inflation pressure is the most important factor in tire life. Pressure should be checked cold before operation **DO NOT** bleed air from tires when they are **hot!** Check inflation pressure weekly during use to insure the maximum tire life and tread wear.

Table 13 (Tire Wear Troubleshooting) will help pinpoint the causes and solutions of tire wear problems.

| TABLE 13. TIRE WEAR TROUBLESHOOTING | | | |
|---|-------------|--------------------------------|---|
| WEAR PATTERN | | CAUSE | SOLUTION |
|  | Center Wear | Over Inflation. | Adjust pressure to particular load per tire manufacturer. |
|  | Edge Wear | Under Inflation. | Adjust pressure to particular load per tire manufacturer. |
|  | Side Wear | Loss of camber or overloading. | Make sure load does not exceed axle rating. Align wheels. |
|  | Toe Wear | Incorrect toe-in. | Align wheels. |
|  | Cupping | Out-of-balance. | Check bearing adjustment and balance tires. |
|  | Flat Spots | Wheel lockup & tire skidding. | Avoid sudden stops when possible and adjust brakes. |

Suspension

The **leaf suspension** springs and associated components (Figure 38) should be visually inspected every 6,000 miles for signs of excessive wear, elongation of bolt holes, and loosening of fasteners. Replace all damaged parts (suspension) immediately. Torqued suspension components as detailed in Table 14.

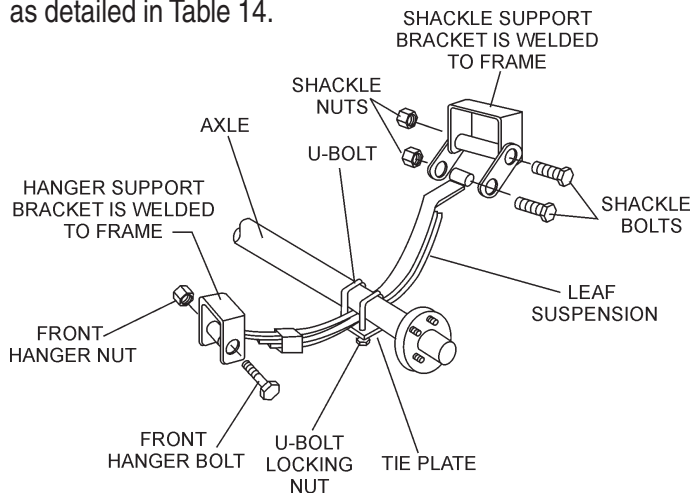

Figure 38. Major Suspension Components

Table 14. Suspension Torque Requirements

| Item | Torque (Ft.-Lbs.) |
|---------------------------------|--|
| 3/8" U-BOLT | MIN-30 MAX-35 |
| 7/16" U-BOLT | MIN-45 MAX-60 |
| 1/2" U-BOLT | MIN-45 MAX-60 |
| SHACKLE BOLT SPRING EYE BOLT | SNUG FIT ONLY. PARTS MUST ROTATE FREELY. LOCKING NUTS OR COTTER PINS ARE PROVIDED TO RETAIN NUT-BOLT ASSEMBLY. |
| SHOULDER TYPE SHACKLE BOLT | MIN-30 MAX-50 |

DCA-15SPXU4 — TRAILER MAINTENANCE

Lug Nut Torque Requirements

It is extremely important to apply and maintain proper wheel mounting torque on the trailer. Be sure to use only the fasteners matched to the cone angle of the wheel. Proper procedure for attachment of the wheels is as follows:

1. Start all wheel lug nuts by hand.
2. Torque all lug nuts in sequence (see Figure 39). **DO NOT** torque the wheel lug nuts all the way down. Tighten each lug nut in 3 separate passes as defined by Table 15.
3. After first road use, retorque all lug nuts in sequence. Check all wheel lug nuts periodically.

Table 15. Tire Torque Requirements

| Wheel Size | First Pass FT-LBS | Second Pass FT-LBS | Third Pass FT-LBS |
|------------|----------------------|-----------------------|----------------------|
| 12" | 20-25 | 35-40 | 50-65 |
| 13" | 20-25 | 35-40 | 50-65 |
| 14" | 20-25 | 50-60 | 90-120 |
| 15" | 20-25 | 50-60 | 90-120 |
| 16" | 20-25 | 50-60 | 90-120 |

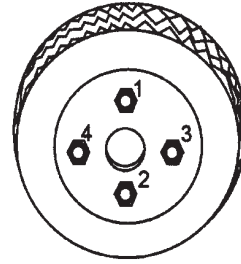

4-LUG NUTS

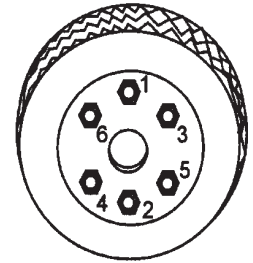

6-LUG NUTS

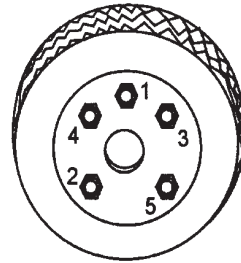

5-LUG NUTS

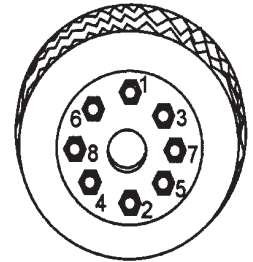

8-LUG NUTS

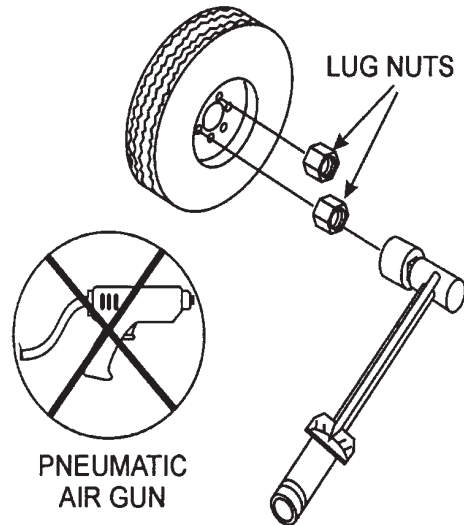
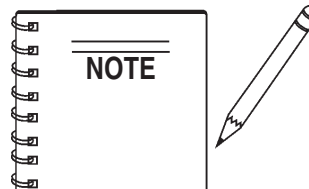
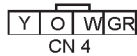
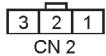
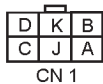
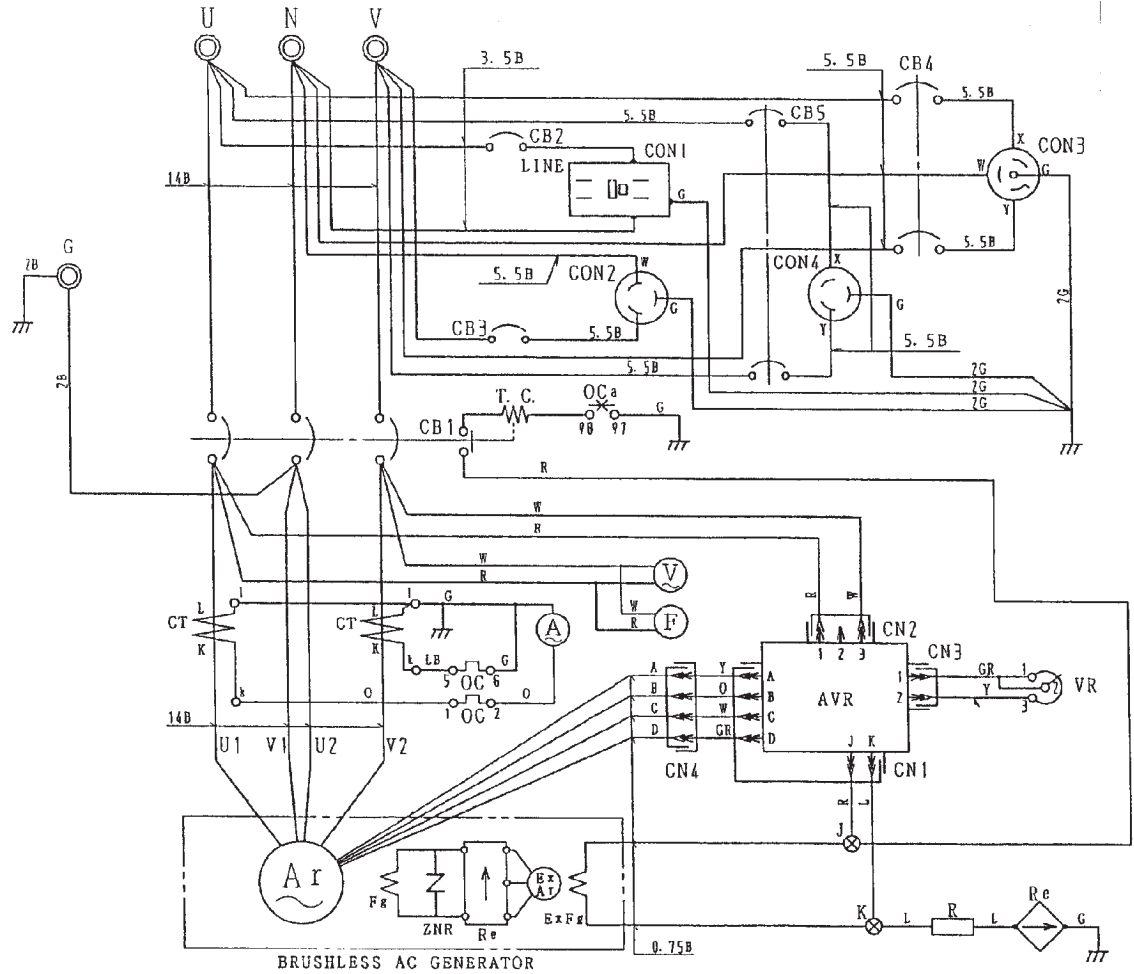

Figure 39. Wheel Lug Nuts Tightening Sequence



NEVER use an pneumatic air gun to tighten wheel lug nuts.

DCA-15SPXU4 — GENERATOR WIRING DIAGRAM



Note: No designation lead size: 1.25

| WIRING COLOR CODE | | | |
|-------------------|--------|--------|-------------|
| SYMBOL | COLOR | SYMBOL | COLOR |
| B | BLACK | R | RED |
| L | BLUE | W | WHITE |
| BR | BROWN | Y | YELLOW |
| G | GREEN | LB | LIGHT BLUE |
| GR | GRAY | LG | LIGHT GREEN |
| V | VIOLET | O | ORANGE |
| P | PINK | | |

CONNECTOR
View at Wiring Side

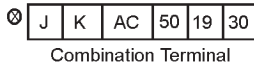

Combination Terminal

| SYMBOL | DESIGNATION |
|--------|------------------------------|
| V | AC.VOLTMETER |
| A | AC.AMMETER |
| F | FREQUENCY METER |
| CT | CURRENT TRANSFORMER, AMMETER |
| U.N.V | OUTPUT TERMINAL |
| AVR | AUTOMATIC VOLTAGE REGULATOR |
| VR | VOLTAGE REGULATOR |
| Cb1 | CIRCUIT BREAKER 3P 70A |
| CB2 | CIRCUIT BREAKER 20A |
| CB3 | CIRCUIT BREAKER 30A |
| CB4 | CIRCUIT BREAKER 50A |
| CB5 | CIRCUIT BREAKER 30A |
| R | RESISTOR |
| Re | RECTIFIER |
| CON1 | RECEPTACLE 20A |
| CON2 | RECEPTACLE 30A |
| CON3 | RECEPTACLE 50A |
| CON4 | RECEPTACLE 30A |
| OC | OVER CURRENT RELAY |
| ⊗ J, K | COMBINATION TERMINAL |
| ⊙ G | GROUND TERMINAL |

Figure 40. Generator Wiring Diagram

DCA-15SPXU4 — ENGINE WIRING DIAGRAM

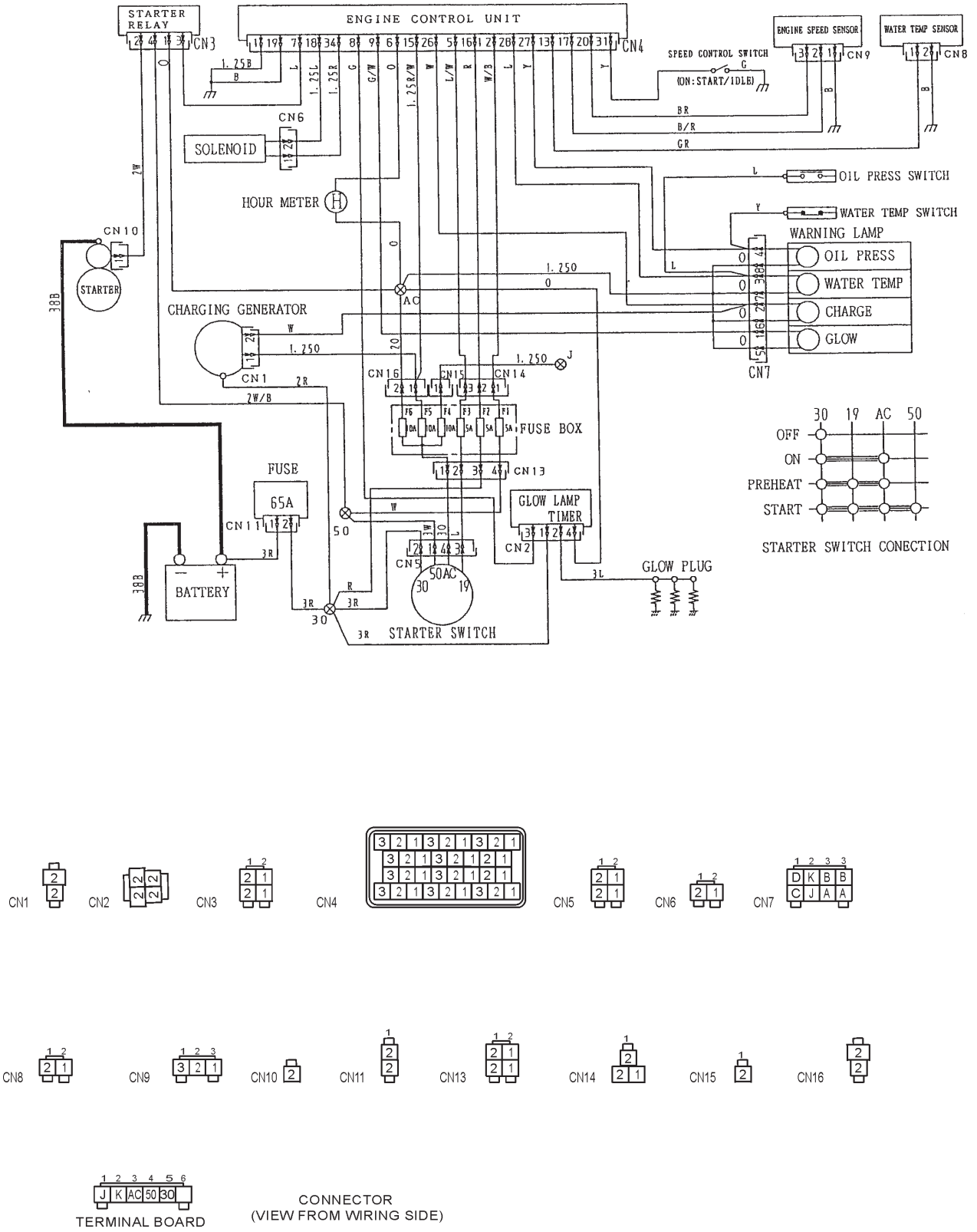

Figure 41. Engine Wiring Diagram

DCA-15SPXU4 — TROUBLESHOOTING (ENGINE)

Practically all breakdowns can be prevented by proper handling and maintenance inspections, but in the event of a breakdown, use Table 16 shown below for diagnosis of the engine. If the problem cannot be remedied, consult our company's business office or service plant.

TABLE 16. ENGINE TROUBLESHOOTING

| SYMPTOM | POSSIBLE PROBLEM | SOLUTION |
|----------------------------|--|---|
| Engine does not start. | No fuel? | Replenish fuel. |
| | Air in the fuel system? | Bleed system. |
| | Water in the fuel system? | Remove water from fuel tank. |
| | Fuel pipe clogged? | Clean fuel pipe. |
| | Fuel filter clogged? | Clean or change fuel filter. |
| | Excessively high viscosity of fuel or engine oil at low temperature? | Use the specified fuel or engine oil. |
| | Fuel with low cetane number? | Use the specified fuel. |
| | Fuel leak due to loose injection pipe retaining nut? | Tighten nut. |
| | Incorrect injection timing? | Adjust. |
| | Fuel cam shaft worn? | Replace. |
| | Injection nozzle clogged? | Clean injection nozzle. |
| | Injection pump malfunctioning? | Repair or replace. |
| | Seizure of crankshaft, camshaft, piston, cylinder liner or bearing? | Repair or replace. |
| | Compression leak from cylinder? | Replace head gasket, tighten cylinder head bolt, glow plug and nozzle holder. |
| | Improper valve timing? | Correct or replace timing gear. |
| | Piston ring and liner worn? | Replace. |
| Excessive valve clearance? | Adjust. | |
| Starter does not run. | Battery discharged? | Charge battery. |
| | Starter malfunctioning? | Repair or replace. |
| | Key switch malfunctioning? | Repair or replace. |
| | Wiring disconnected? | Connect wiring. |

TABLE 16. ENGINE TROUBLESHOOTING (CONTINUED)

| SYMPTOM | POSSIBLE PROBLEM | SOLUTION |
|--|--|---|
| Engine revolution is not smooth. | Fuel filter clogged or dirty? | Clean or change. |
| | Air cleaner clogged? | Clean or change. |
| | Fuel leak due to loose injection pipe retaining nut? | Tighten nut. |
| | Injection pump malfunctioning? | Repair or replace. |
| | Incorrect nozzle opening pressure? | Adjust. |
| | Injection nozzle stuck or clogged? | Repair or replace. |
| | Fuel over flow pipe clogged? | Clean. |
| | Governor malfunctioning? | Repair. |
| Either white or blue exhaust gas is observed. | Excessive engine oil? | Reduce to the specified level. |
| | Piston ring and liner worn or stuck? | Repair or replace. |
| | Incorrect injection timing? | Adjust. |
| | Deficient compression? | Adjust top clearance. |
| Either black or dark gray exhaust gas is observed. | Overload? | Lessen the load. |
| | Low grade fuel used? | Use the specified fuel. |
| | Fuel filter clogged? | Clean or change. |
| | Air cleaner clogged? | Clean or change. |
| | Deficient nozzle injection? | Repair or replace the nozzle. |
| Deficient output. | Incorrect injection timing? | Adjust. |
| | Engine's moving parts seem to be seizing? | Repair or replace. |
| | Uneven fuel injection? | Repair or replace the injection pump. |
| | Deficient nozzle injection? | Repair or replace the nozzle. |
| | Compression leak? | Replace head gasket, tighten cylinder head bolt, glow plug and nozzle holder. |

DCA-15SPXU4 — TROUBLESHOOTING (GENERATOR)

Practically all breakdowns can be prevented by proper handling and maintenance inspections, but in the event of a breakdown, use Table 17 shown below for diagnosis of the generator. If the problem cannot be remedied, consult our company's business office or service plant.

TABLE 17. GENERATOR TROUBLESHOOTING

| SYMPTOM | POSSIBLE PROBLEM | SOLUTION |
|-------------------------|-------------------------------|---|
| No Voltage Output | AC Voltmeter defective? | Check output voltage using a voltmeter. |
| | Is wiring connection loose? | Check wiring and repair. |
| | Is AVR defective? | Replace if necessary. |
| | Defective Rotating Rectifier? | Check and replace. |
| | Defective Exciter Field? | Check for 17.3 ohms across J & K on CN1 |
| Low Voltage Output | Is engine speed correct? | Turn engine throttle lever to "High". |
| | Is wiring connections loose? | Check wiring and repair. |
| | Defective AVR? | Replace if necessary. |
| High Voltage Output | Is wiring connections loose? | Check wiring and repair. |
| | Defective AVR? | Replace if necessary. |
| Circuit Breaker Tripped | Short Circuit in load? | Check load and repair. |
| | Over current? | Confirm load requirements and reduce. |
| | Defective circuit breaker? | Check and replace. |
| | Over current Relay actuated? | Confirm load requirement and replace. |

DCA-10SPX4 — TROUBLESHOOTING (PRE-HEAT LAMP CODES)

When the Emergency/Malfunction Diagnosis Function has been activated, it stops the engine and flashes the pre-heat lamp to indicate the cause of the malfunction with its flashing patterns. The flashing patterns and countermeasures are shown below. The patterns consist of combinations of one or more long flashes and one or more short flashes.

TABLE 18. FAILURE DIAGNOSIS LAMP CODE

| LOCATION OF FAULT | POSSIBLE FAULT REASONS | INDICATION | SUGGESTED REPAIRS |
|-----------------------------|--|----------------|--|
| Engine Over Speed | 115% or more the rated revolution speed | 1 Long 1 Short | Check all of the connections. If connections are sound, contact the Service Department for repairs. |
| Low Oil Pressure | Engine stops at 49kPa or more (oil pressure lamp on) | 1 Long 2 Short | |
| Insufficient Charge | Charging generator has no voltage | 1 Long 3 Short | |
| Rotation Sensor | Defective sensor, disconnection, short circuit | 2 Long 1 Short | |
| Solenoid | Disconnection, short circuit | 2 Long 2 Short | |
| Water Temperature Sensor | Disconnection | 2 Long 4 Short | |
| | Short circuit | 2 Long 5 Short | |
| Charging Generator Terminal | Disconnection | 2 Long 6 Short | |
| Over Voltage | VCC at 18V or more | 2 Long 7 Short | |
| High Water Temperature | Engine stops at 115C or more | 1 Long 4 Short | Make sure that routine service has been performed, and check thermo switch. If the problem persists, contact the Service Department for repairs. |

OPERATION MANUAL

HERE'S HOW TO GET HELP

PLEASE HAVE THE MODEL AND SERIAL
NUMBER ON-HAND WHEN CALLING

UNITED STATES

Multiquip Corporate Office

18910 Wilmington Ave. Tel. (800) 421-1244
Carson, CA 90746 Fax (800) 537-3927
Contact: mq@multiquip.com

Service Department

800-421-1244 Fax: 310-537-4259
310-537-3700

Technical Assistance

800-478-1244 Fax: 310-943-2238

MQ Parts Department

800-427-1244 Fax: 800-672-7877
310-537-3700 Fax: 310-637-3284

Warranty Department

800-421-1244 Fax: 310-537-1173
310-537-3700

MEXICO

MQ Cipsa

Carr. Fed. Mexico-Puebla KM 126.5 Tel: (52) 222-225-9900
Momoxpan, Cholula, Puebla 72760 Mexico Fax: (52) 222-285-0420
Contact: pmastretta@cipsa.com.mx

CANADA

Multiquip

4110 Industriel Boul. Tel: (450) 625-2244
Laval, Quebec, Canada H7L 6V3 Tel: (877) 963-4411
Contact: jmartin@multiquip.com Fax: (450) 625-8664

UNITED KINGDOM

Multiquip (UK) Limited Head Office

Unit 2, Northpoint Industrial Estate, Tel: 0161 339 2223
Globe Lane, Fax: 0161 339 3226
Dukinfield, Cheshire SK16 4UJ
Contact: sales@multiquip.co.uk

© COPYRIGHT 2011, MULTIQUIP INC.

Multiquip Inc and the MQ logo are registered trademarks of Multiquip Inc. and may not be used, reproduced, or altered without written permission. All other trademarks are the property of their respective owners and used with permission.

This manual MUST accompany the equipment at all times. This manual is considered a permanent part of the equipment and should remain with the unit if resold.

The information and specifications included in this publication were in effect at the time of approval for printing. Illustrations, descriptions, references and technical data contained in this manual are for guidance only and may not be considered as binding. Multiquip Inc. reserves the right to discontinue or change specifications, design or the information published in this publication at any time without notice and without incurring any obligations.

Your Local Dealer is:

