

MV440 Built-in Microwave and Grill

Manual for Installation, Use and Maintenance



|C|D|A|





INSTALLATION



MOUNTING THE APPLIANCE



FOLLOW THE SUPPLIED separate mounting instructions when installing the appliance.

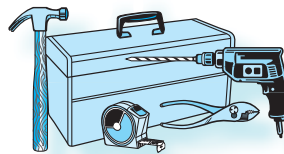

PRIOR TO CONNECTING

CHECK THAT THE VOLTAGE on the rating plate corresponds to the voltage in your home.

DO NOT REMOVE THE MICROWAVE INLET PROTECTION PLATES located on the side of the oven cavity wall. They prevent grease & food particles from entering the microwave inlet channels.

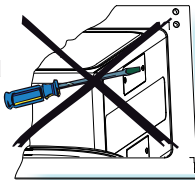

ENSURE the oven cavity is empty before mounting.

ENSURE THAT THE APPLIANCE IS NOT DAMAGED. Check that the oven door closes firmly against the door support and that the internal door seal is not damaged. Empty the oven and clean the interior with a soft, damp cloth.

DO NOT OPERATE THIS APPLIANCE if it has a damaged mains cord or plug, if it is not working properly, or if it has been damaged or dropped. Do not immerse the mains cord or plug in water. Keep the cord away from hot surfaces. Electrical shock, fire or other hazards may result.

AFTER CONNECTING

THE OVEN CAN BE OPERATED ONLY if the oven door is firmly closed.

THE EARTHING OF THIS APPLIANCE is compulsory. The manufacturer will accept no responsibility for injury to persons, animals or damage to objects arising from the non-observance of this requirement.

The manufacturers are not liable for any problems caused by the user's failure to observe these instructions.



IMPORTANT SAFETY INSTRUCTIONS



READ CAREFULLY AND KEEP FOR FUTURE REFERENCE

DO NOT HEAT, OR USE FLAMMABLE MATERIALS in or near the oven. Fumes can create a fire hazard or explosion.

DO NOT USE YOUR MICROWAVE oven for drying textiles, paper, spices, herbs, wood, flowers, fruit or other combustible materials. Fire could result.

IF MATERIAL INSIDE / OUTSIDE THE OVEN SHOULD IGNITE OR SMOKE IS OBSERVED, keep oven door closed and turn the oven off. Disconnect the power cord or shut off power at the fuse or circuit breaker panel.

DO NOT OVER-COOK FOOD. Fire could result.

DO NOT LEAVE THE OVEN UNATTENDED, especially when using paper, plastic or other combustible materials in the cooking process. Paper can char or burn and some plastics can melt if used when heating foods.

DO NOT USE corrosive chemicals or vapors in this appliance. This type of oven is specifically designed to heat or cook food. It is not designed for industrial or laboratory use.

ONLY ALLOW CHILDREN to use the appliance under adult supervision and after adequate instructions have been given, so that the child is able to use the appliance in a safe way and understands the hazards of improper use.

THIS APPLIANCE IS NOT INTENDED FOR use by persons (including children) with reduced physical, sensory or mental capabilities, unless used under the supervision of a person responsible for their safety.

ACCESSIBLE PARTS MAY BECOME HOT during use, young children should be kept away

DO NOT USE YOUR MICROWAVE oven for heating anything in airtight sealed containers. The pressure increases and may cause damage when opening or may explode.



THE DOOR SEALS AND THE DOOR SEAL AREAS must be regularly inspected for damage. If these areas are damaged the appliance should not be operated until it has been repaired by a trained service technician.

EGGS

DO NOT USE YOUR MICROWAVE oven for cooking or reheating whole eggs with or without shell since they may explode even after microwave heating has ended.





IMPORTANT PRECAUTIONS



GENERAL

THIS APPLIANCE IS DESIGNED FOR DOMESTIC USE ONLY!

THE APPLIANCE SHOULD NOT BE OPERATED without food in the oven when using microwaves. Operation in this manner is likely to damage the appliance.

IF YOU PRACTICE OPERATING the oven, put a glass of water inside. The water will absorb the microwave energy and the oven will not be damaged.

DO NOT USE THE CAVITY for any storage purposes.

REMOVE WIRE TWIST-TIES from paper or plastic bags before placing bag in the oven.



DEEP-FRYING

DO NOT USE YOUR MICROWAVE oven for deep-frying, because the oil temperature cannot be controlled.

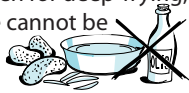

USE HOT PADS OR OVEN MITTS to prevent burns, when touching containers, oven parts, and pan after cooking.

LIQUIDS

E.G. BEVERAGES OR WATER. Overheating the liquid beyond boiling point can occur without evidence of bubbling. This could result in a sudden boil over of the hot liquid.



To prevent this possibility the following steps should be taken:

1. Avoid using straight-sided containers with narrow necks.
2. Stir the liquid before placing the container in the oven and let the teaspoon remain in the container.
3. After heating, allow standing for a short time, stirring again before carefully removing the container from the oven.

CAREFUL

ALWAYS REFER to a microwave cookbook for details. Especially, if cooking or reheating food that contains alcohol.

AFTER HEATING BABY FOOD or liquids in a baby bottle or in a baby food jar, always stir and check the temperature before serving.



This will ensure that the heat is evenly distributed and the risk of scalding or burns can be avoided.

Ensure the Lid and the Teat is removed before heating!



ACCESSORIES



GENERAL

THERE ARE a number of accessories available on the market. Before you buy, ensure they are suitable for microwave use.

ENSURE THAT THE UTENSILS YOU USE are oven proof and allow microwaves to pass through them before cooking.



WHEN YOU PUT FOOD AND ACCESSORIES in the microwave oven, ensure that they do not come in contact with the interior of the oven.

This is especially important with accessories made of metal or metal parts.

IF ACCESSORIES CONTAINING METAL comes in contact with the oven interior, while the oven is in operation, sparking can occur and the oven could be damaged.

ALWAYS ENSURE that the turntable is able to turn freely before starting the oven.

TURNTABLE SUPPORT

USE THE TURNTABLE SUPPORT under the Glass turntable. Never put any other utensils on the turntable support.

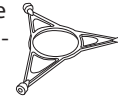

☞ Fit the turntable support in the oven.

GLASS TURNTABLE

USE THE GLASS TURNTABLE with all cooking methods. It collects the dripping juices and food particles that otherwise would stain and soil the interior of the oven.

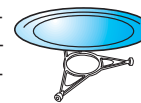

☞ Place the Glass turntable on the turntable support.

WIRE RACK

USE THE WIRE RACK when cooking with Grill functions.

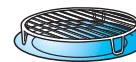

START PROTECTION / KEY LOCK



THIS AUTOMATIC SAFETY FUNCTION IS ACTIVATED ONE MINUTE AFTER the oven has returned to "stand by mode". (The oven is in "stand by" when the 24-hour clock is displayed or if the clock has not been set, when the display is blank).



THE DOOR MUST BE OPENED AND CLOSED e.g. putting food into it, before the safety lock is released. Else the display will show "DOOR".

DOOR



DONENESS (AUTO FUNCTIONS ONLY)



DONENESS IS AVAILABLE in most of the auto functions. You have the possibility to personally control the end result through the Adjust doneness feature. This feature enables you to achieve higher or lower end temperature compared to the default standard setting.

WHEN USING one of these functions the oven chooses the default standard setting. This setting normally gives you the best result. But if the food you heated became too warm to eat at once, you can easily adjust this before you use that function the next time.

DONENESS	
LEVEL	EFFECT
HIGH +2	YIELDS HIGHEST END TEMPERATURE
HIGH +1	YIELDS HIGHER END TEMPERATURE
MED 0	DEFAULT STANDARD SETTING
LOW -1	YIELDS LOWER END TEMPERATURE
LOW -2	YIELDS LOWEST END TEMPERATURE

NOTE:

THE DONENESS can only be set or altered during the first 20 seconds of operation.

HIGH+²
AUTO

HIGH¹
AUTO

THIS IS DONE BY SELECTING A DONENESS LEVEL with the +/- buttons right after you have pressed the Start button.

MED⁰
AUTO

LOW⁻¹
AUTO

LOW-⁻²
AUTO



STIR OR TURN FOOD (AUTO FUNCTIONS ONLY)



WHEN USING SOME OF THE AUTO FUNCTIONS the oven may stop (depending on the chosen program and food class) and prompt you to STIR FOOD or TURN FOOD.

NOTE: THE OVEN CONTINUES AUTOMATICALLY AFTER 1 MIN. if the food hasn't been turned / stirred. The heating time will be longer in this case.

TO CONTINUE COOKING:

- 🌀 Open the door.
- 🌀 Stir or turn the food.
- 🌀 Close the door and restart by pressing the Start button.







FOOD CLASSES (AUTO FUNCTIONS ONLY)



WHEN USING THE AUTO FUNCTIONS the oven needs to know which food class it is to use to reach proper results. The word **FOOD** and a food class digit is displayed when you are choosing a food class with the +/- buttons.

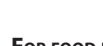

FOOD	
	1 DINNER PLATE (250g - 500g)
	2 SOUP (200g -
	3
	4
	5

THE FOOD CLASSES are listed in the tables placed with each Auto function.

FOR FOOD NOT LISTED IN THE TABLES and if the weight is lesser or greater than recommended weights, you should follow the procedure for "Cook & Reheat with microwaves".



COOLING DOWN



WHEN A FUNCTION IS FINISHED, the oven may carry out a cooling procedure. This is normal. After this procedure the oven switches off automatically.

IF THE TEMPERATURE IS HIGHER THAN 50°C, "HOT" and the current cavity temperature is displayed. Be careful not to touch the cavity inside when removing food. Use oven mittens.

IF THE TEMPERATURE IS LESS THAN 50°C, the 24 hour clock is displayed.

PRESS THE BACK BUTTON to temporarily view the 24 hour clock when "HOT" is displayed.

THE COOLING PROCEDURE can be interrupted without any harm to the oven by opening the door.





CHANGING SETTINGS



WHEN THE APPLIANCE IS FIRST PLUGGED IN it will ask you to set the Clock.
AFTER A POWER FAILURE the Clock will flash and needs to be reset.
YOUR OVEN HAS a number of functions which can be adjusted to your personal taste.

- 1 **PRESS THE MANUAL BUTTON** until Setting is shown.
- 2 **USE THE +/- BUTTONS** to choose one of the following settings to adjust.
 - ⚙️ Clock
 - 🔊 Sound
 - 🌿 ECO
 - 💡 Brightness
- 3 **PRESS THE STOP BUTTON** TO EXIT the settings function and save all your changes when you are done.

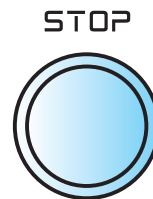

⌵

CLOCK SETTING

⌵



KEEP THE DOOR OPEN WHILE SETTING THE Clock. This gives you 5 minutes to complete the setting of the Clock. Otherwise, each step must be accomplished within 60 seconds.

- 1 **PRESS THE SELECT BUTTON.** (The left right hand digits (hours) flicker).
- 2 **PRESS THE +/- BUTTONS** to set the hours.
- 3 **PRESS THE SELECT BUTTON.** (The two right hand digits (minutes) flicker).
- 4 **PRESS THE +/- BUTTONS** to set the minutes.
- 5 **PRESS THE SELECT BUTTON** again to confirm the change.

THE CLOCK IS SET AND IN OPERATION.

IF YOU WISH TO REMOVE THE Clock from the display once it has been set, simply enter the clock setting mode again and press the Stop button while the digits flicker.

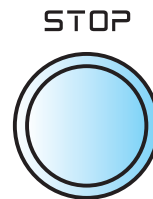



CHANGING SETTINGS



SOUND SETTING

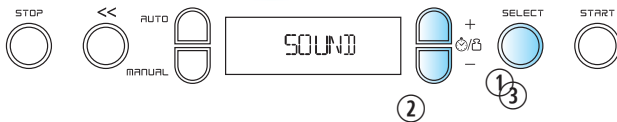

- 1 PRESS THE **SELECT** BUTTON.
- 2 PRESS THE **+/-** BUTTONS to turn the buzzer ON or OFF.
- 3 PRESS THE **SELECT** BUTTON again to confirm the change.

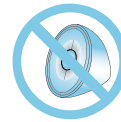

ECO



- 1 PRESS THE **SELECT** BUTTON.
- 2 PRESS THE **+/-** BUTTONS to turn the ECO setting ON or OFF.
- 3 PRESS THE **SELECT** BUTTON again to confirm the change.

WHEN ECO IS ON, the display will automatically turn off after a while to save energy. It will automatically light up again when a button is pressed or the door is opened. At cooking end cavity lamp switches off after 30 seconds.

WHEN OFF IS SET, the display will not turn off and the 24 h clock will always be visible. At cooking end cavity lamp switches off after 3 minutes.



CHANGING SETTINGS



BRIGHTNESS



- 1 **PRESS THE SELECT BUTTON.**
- 2 **PRESS THE +/- BUTTONS** to set the level of brightness suitable to your preference.
- 3 **PRESS THE SELECT BUTTON** again to confirm your selection.



KITCHEN TIMER



USE THIS FUNCTION when you need a kitchen timer to measure exact time for various purposes such as cooking eggs or letting the dough rise before baking etc.

- 1 **PRESS THE +/- BUTTONS** to set the desired length of the timer.
- 2 **PRESS THE SELECT BUTTON.**

AN ACOUSTIC SIGNAL will be heard when the timer has finished to count down.

PRESSING THE STOP BUTTON before the timer has finished will reset the timer to zero.

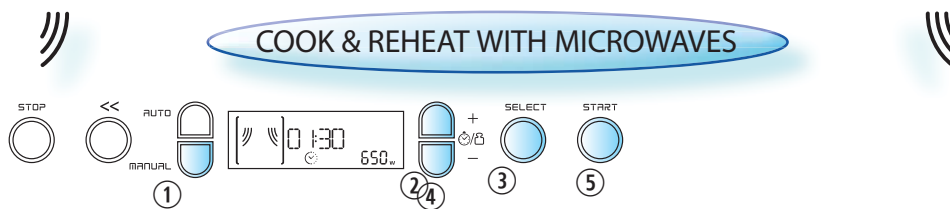

Use this function for normal cooking and reheating, such as vegetables, fish, potatoes and meat.

- 1 **PRESS THE MANUAL BUTTON** repeatedly until you find the microwave function.
- 2 **PRESS THE +/- BUTTONS** to set the microwave power level.
- 3 **PRESS THE SELECT BUTTON** to confirm your selection. You will automatically be taken to the next setting.
- 4 **PRESS THE +/- BUTTONS** to set the cooking time.
- 5 **PRESS THE START BUTTON.**

ONCE THE COOKING PROCESS HAS BEEN STARTED:

The time can easily be increased in 30-second steps by pressing the Start button. *Each press* increases the time with 30 seconds. You may also alter the time by pressing the +/- buttons to increase or decrease the time.

BY PRESSING THE << BUTTON you may return to where you can change cooking time and power level. Both can be altered with the +/- buttons during cooking.



POWER LEVEL

MICROWAVES ONLY	
POWER	SUGGESTED USE:
1000 W	REHEATING OF BEVERAGES, water, clear soups, coffee, tea or other food with a high water content. If the food contains egg or cream choose a lower power.
800 W	COOKING OF VEGETABLES, meat etc.
650 W	COOKING OF fish.
500 W	MORE CAREFUL COOKING e.g. high protein sauces, cheese and egg dishes and to finish cooking casseroles.
350 W	SIMMERING STEWS, melting butter & chocolate.
160 W	DEFROSTING. Softening butter, cheeses.
90 W	SOFTENING Ice cream
0 W	WHEN USING the Timer only.

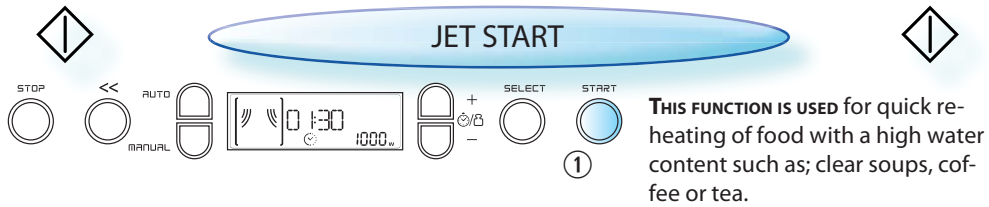

- 1 **PRESS THE START BUTTON TO AUTOMATICALLY START** with full microwave power level and the cooking time set to 30 seconds. Each additional press increases the time with 30 seconds.

YOU MAY ALSO ALTER THE TIME BY PRESSING THE +/- BUTTONS to increase or decrease the time after the function has started.

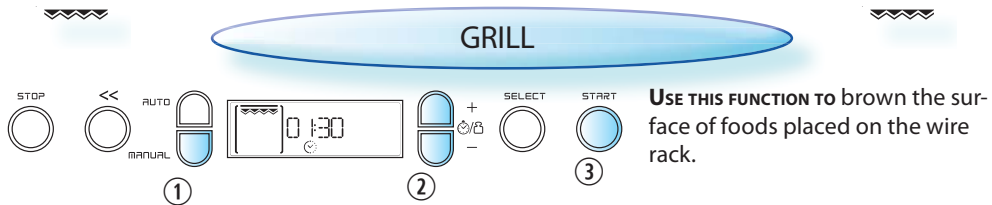

- 1 **PRESS THE MANUAL BUTTON** repeatedly until you find the Grill function.
- 2 **PRESS THE +/- BUTTONS** to set the cooking time.
- 3 **PRESS THE START BUTTON.**

PLACE FOOD on the wire rack. Turn food during cooking.

ENSURE THAT THE UTENSILS used are heat resistant and ovenproof before grilling with them.

DO NOT USE PLASTIC utensils when grilling. They will melt. Items of wood or paper are not suitable either.

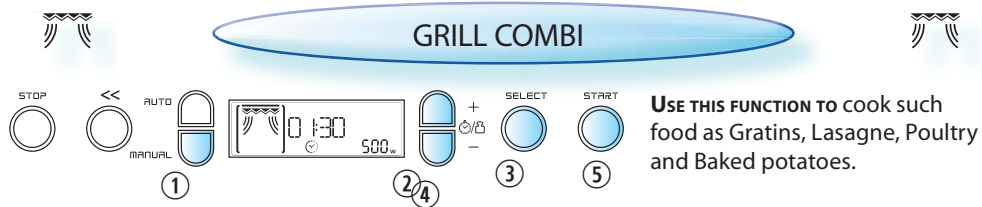

- 1 **PRESS THE MANUAL BUTTON** repeatedly until you find the Grill Combi function.
- 2 **PRESS THE +/- BUTTONS** to set the microwave power level.
- 3 **PRESS THE SELECT BUTTON** to confirm your selection. You will automatically be taken to the next setting.
- 4 **PRESS THE +/- BUTTONS** to set the cooking time.
- 5 **PRESS THE START BUTTON.**

THE MAX. POSSIBLE microwave power level when using the Grill Combi is limited to a factory-preset level.

GRILL COMBI	
POWER	SUGGESTED USE:
650 W	COOKING Vegetables & Gratins
350 - 500 W	COOKING Poultry & Lasagne
160 - 350 W	COOKING Fish & frozen gratins
160 W	COOKING Meat
90 W	GRATINATING fruit
0 W	BROWNING only during cooking



MANUAL DEFROST



FOLLOW THE PROCEDURE for “Cook & Reheat with microwaves” and choose power level 160 W when defrosting manually.

CHECK AND INSPECT THE FOOD REGULARLY. Experience will give you the times needed for various amounts.

FROZEN FOOD IN PLASTIC BAGS, plastic films or cardboard packages can be placed directly in the oven as long as the package has no metal parts (e.g. metal twist ties).

TURN LARGE JOINTS halfway through the defrosting process.

THE SHAPE OF THE PACKAGE alters the defrosting time. Shallow packets defrost more quickly than a deep block.



BOILED FOOD, STEWS AND MEAT SAUCES defrost better if stirred during defrosting time.

WHEN DEFROSTING it is better to under-thaw the food slightly and allow the process to finish during standing time.

SEPARATE PIECES as they begin to defrost. Individual slices defrost more easily.

STANDING TIME AFTER DEFROSTING ALWAYS IMPROVES the result since the temperature will then be evenly distributed throughout the food.

SHIELD AREAS OF FOOD with small pieces of aluminum foil if they start to become warm (e.g. chicken legs and wing tips).

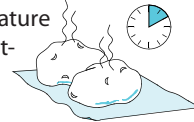

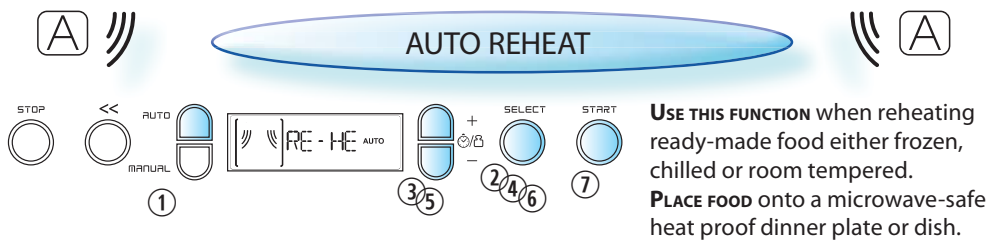

- 1 **PRESS THE AUTO BUTTON** repeatedly until you find the Auto Reheat function.
- 2 **PRESS THE SELECT BUTTON** to confirm your selection. You will automatically be taken to the next setting.
- 3 **PRESS THE +/- BUTTONS** to select food class. ("FOOD" and food class is displayed).
- 4 **PRESS THE SELECT BUTTON** to confirm your selection. You will automatically be taken to the next setting.
- 5 **PRESS THE +/- BUTTONS** to set the weight.
- 6 **PRESS THE SELECT BUTTON** to confirm your selection.
- 7 **PRESS THE START BUTTON.**

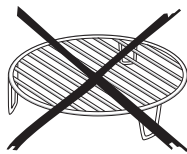



AUTO REHEAT



WHEN YOU ARE SAVING a meal in the refrigerator or "plating" a meal for reheating, arrange the



thicker, denser food to the outside of the plate and the thinner or less dense food in the middle.



ALWAYS COVER FOOD when using this function except when reheating chilled soups in which case a cover is not needed!

IF THE FOOD IS PACKAGED in such way that it already have a cover, the package should be cut with 2-3 scores to allow for excess pressure to escape during reheating.

PLACE THIN SLICES of meat on top of each other or interlace them.



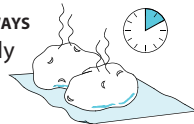

THICKER SLICES such as meat loaf and sausages have to be placed close to each other.

1-2 MINUTES STANDING TIME ALWAYS IMPROVES the result, especially for frozen food.



PLASTIC FOIL should be scored or pricked with a fork, to relieve the pressure and to prevent bursting, as steam builds-up during cooking.



FOOD		HINTS
	1 DINNER PLATE (250g - 500g)	PREPARE FOOD in line with recommendations above. Heat under cover.
	2 SOUP (200g - 800g)	REHEAT UNCOVERED in separate bowls or in a large one.
	3 FROZEN PORTION (250g - 500g)	FOLLOW THE DIRECTIONS ON PACKAGE , IE. ventilation, pricking and so on.
	4 BEVERAGE (0,1 - 0,5l)	HEAT UNCOVERED and use a metal spoon in a mug or cup.
	5 FROZEN LASAGNE (250g - 500g)	PLACE in an ovenproof and microwave safe dish.
FOR FOOD NOT LISTED IN THIS TABLE and if the weight is lesser or greater than recommended weight, you should follow the procedure for "Cook & Reheat with microwaves".		

JET DEFROST

USE THIS FUNCTION for defrosting Meat, Poultry, Fish, Vegetables and Bread.
 Jet Defrost should only be used if the net weight is between 100 g-2.5 kg.
ALWAYS PLACE THE FOOD on the glass turntable.

- 1 **PRESS THE AUTO BUTTON** repeatedly until you find the Jet Defrost function.
- 2 **PRESS THE SELECT BUTTON** to confirm your selection. You will automatically be taken to the next setting.
- 3 **PRESS THE +/- BUTTONS** to select food class. ("FOOD" and food class is displayed).
- 4 **PRESS THE SELECT BUTTON** to confirm your selection. You will automatically be taken to the next setting.
- 5 **PRESS THE +/- BUTTONS** to set the weight.
- 6 **PRESS THE SELECT BUTTON** to confirm your selection.
- 7 **PRESS THE START BUTTON.**

TURN FOOD

MIDWAY THRU THE DEFROSTING PROCESS the oven stops and prompts you to "TURN" food.

- 🔵 Open the door.
- 🔵 Turn the food.
- 🔵 Close the door and restart by pressing the Start button.

NOTE: the oven continues after 2 min if the food hasn't been turned. The defrosting time will be longer in this case.

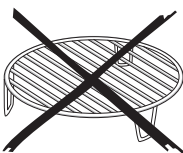



JET DEFROST



WEIGHT:

THIS FUNCTION NEEDS TO KNOW the net weight of the food. The oven will then automatically calculate the needed time to finish the procedure.



IF THE WEIGHT IS LESSER OR GREATER THAN RECOMMENDED WEIGHT: Follow the procedure for "Cook & Reheat with microwaves" and choose 160 W when defrosting.

FROZEN FOODS:

IF THE FOOD IS WARMER than deep-freeze temperature (-18°C), choose lower weight of the food.

IF THE FOOD IS COLDER than deep-freeze temperature (-18°C), choose higher weight of the food.



FOOD		HINTS
	1 MEAT (100g - 2.0Kg)	Minced meat, cutlets, steaks or roasts. TURN FOOD when oven prompts.
	2 POULTRY (100g - 2.5Kg)	Chicken whole, pieces or fillets. TURN FOOD when oven prompts.
	3 FISH (100g - 2.0Kg)	Whole, steaks or fillets. TURN FOOD when oven prompts.
	4 VEGETABLES (100g - 2.0Kg)	Mixed vegetables, peas, broccoli etc. TURN FOOD when oven prompts.
	5 BREAD (100g - 1.0Kg)	Loaf, buns or rolls. TURN FOOD when oven prompts.
FOR FOOD NOT LISTED IN THIS TABLE and if the weight is lesser or greater than recommended weight, you should follow the procedure for "Cook and reheat with microwaves" and choose 160 W when defrosting.		

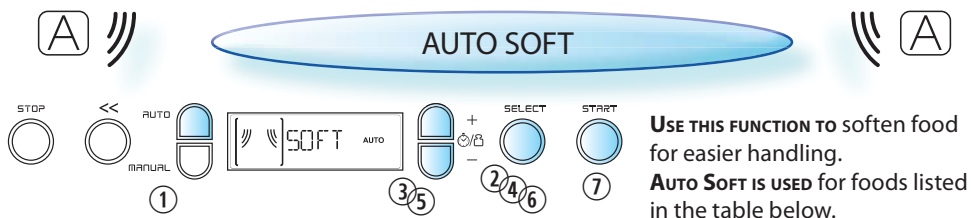

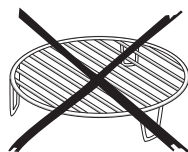

- 1 **PRESS THE AUTO BUTTON** repeatedly until you find the Auto Soft function.
- 2 **PRESS THE SELECT BUTTON** to confirm your selection. You will automatically be taken to the next setting.
- 3 **PRESS THE +/- BUTTONS** to select food class. ("FOOD" and food class is displayed).
- 4 **PRESS THE SELECT BUTTON** to confirm your selection. You will automatically be taken to the next setting.
- 5 **PRESS THE +/- BUTTONS** to set the weight.
- 6 **PRESS THE SELECT BUTTON** to confirm your selection.
- 7 **PRESS THE START BUTTON.**

	FOOD	HINTS
	1 BUTTER (50g - 100g)	TURN FOOD when oven prompts. STIR also after softening.
	2 MARGARINE (50g - 100g)	TURN FOOD when oven prompts. STIR ALSO after softening.
	3 ICE CREAM (0,5l - 1,0l)	TURN FOOD when oven prompts. SERVE quickly before further melting.
FOR FOOD NOT LISTED IN THIS TABLE and if the weight is lesser or greater than recommended weight, you should follow the procedure for "Cook and reheat with microwaves"		

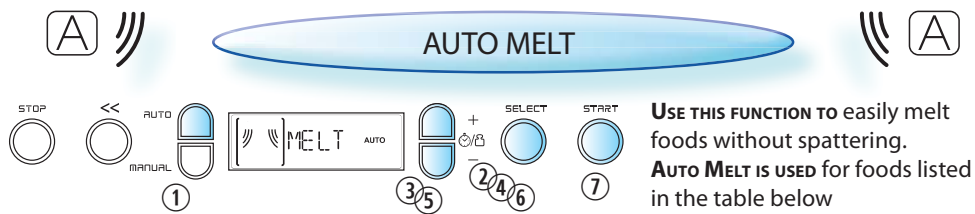

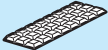

- 1 PRESS THE **AUTO** BUTTON repeatedly until you find the Auto Melt function.
- 2 PRESS THE **SELECT** BUTTON to confirm your selection. You will automatically be taken to the next setting.
- 3 PRESS THE **+/-** BUTTONS to select food class. ("FOOD" and food class is displayed).
- 4 PRESS THE **SELECT** BUTTON to confirm your selection. You will automatically be taken to the next setting.
- 5 PRESS THE **+/-** BUTTONS to set the weight.
- 6 PRESS THE **SELECT** BUTTON to confirm your selection.
- 7 PRESS THE **START** BUTTON.

	FOOD	HINTS
	1 BUTTER (50g - 200g)	STIR FOOD when oven prompts. STIR ALSO after melting.
	2 MARGARINE (50g - 200g)	STIR FOOD when oven prompts. STIR ALSO after melting.
	3 CHOCOLATE (50g - 200g)	BREAK into smaller pieces. STIR FOOD when oven prompts. STIR ALSO after melting. PLEASE NOTE: Chocolate with high content of cocoa, may require Doneness level high (+2)
FOR FOOD NOT LISTED IN THIS TABLE and if the weight is lesser or greater than recommended weight, you should follow the procedure for "Cook and reheat with microwaves"		

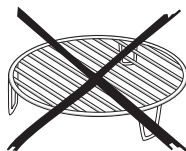

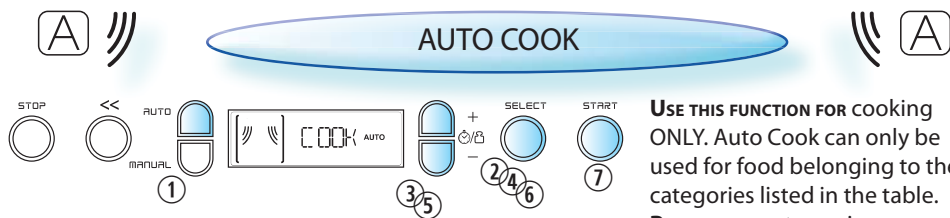

USE THIS FUNCTION FOR cooking ONLY. Auto Cook can only be used for food belonging to the categories listed in the table.
PLACE FOOD onto a microwave-safe heat proof dinner plate or dish.

- 1 **PRESS THE AUTO BUTTON** repeatedly until you find the Auto Cook function.
- 2 **PRESS THE SELECT BUTTON** to confirm your selection. You will automatically be taken to the next setting.
- 3 **PRESS THE +/- BUTTONS** to select food class. ("FOOD" and food class is displayed).
- 4 **PRESS THE SELECT BUTTON** to confirm your selection. You will automatically be taken to the next setting.
- 5 **PRESS THE +/- BUTTONS** to set the weight.
- 6 **PRESS THE SELECT BUTTON** to confirm your selection.
- 7 **PRESS THE START BUTTON.**

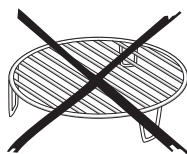



AUTO COOK







CANNED VEGETABLES: Always open the can and pour the content into a microwave safe dish. Never cook the vegetables in the tin packaging.

Cook fresh, frozen or canned vegetables covered.



PLASTIC FOIL should be scored or pricked with a fork, to relieve the pressure and to prevent bursting, as steam builds-up during cooking.





RECOMMENDED WEIGHTS		
	1 BAKED POTATOES (200g - 1Kg)	PRICK THE POTATOES and place them in a microwave safe and oven proof dish. Turn the potatoes when the oven beeps. Please be aware that the oven, dish and food are hot. TURN FOOD when oven prompts.
	2 FRESH VEGETABLES (200g - 800g)	CUT VEGETABLES into even size pieces. Add 2-4 table spoons water and cover. Stir when oven beeps. STIR FOOD when oven prompts.
	3 FROZEN VEGETABLES (200g - 800g)	COOK UNDER COVER. Stir when oven beeps. STIR FOOD when oven prompts.
	4 CANNED VEGETABLES (200g - 600g)	COOK IN A MICROWAVE SAFE dish with cover.
	5 POPCORN (100g)	ONLY COOK ONE BAG at the time. If more popcorn is needed, cook the bags one after another.
FOR FOOD NOT LISTED IN THIS TABLE and if the weight is lesser or greater than recommended weight, you should follow the procedure for "Cook and reheat with microwaves"		

MAINTENANCE & CLEANING

CLEANING IS THE ONLY MAINTENANCE normally required.

FAILURE TO MAINTAIN THE OVEN in a clean condition could lead to deterioration of the surface that could adversely affect the life of the appliance and possibly result in a hazardous situation.

 **DO NOT USE METAL SCOURING PADS, ABRASIVE CLEANSERS, steel-wool pads, gritty washcloths, etc. which can damage the control panel, and the interior and exterior oven surfaces. Use a sponge with a mild detergent or a paper towel with spray glass cleaner. Apply spray glass cleaner to a paper towel. Do NOT SPRAY directly on the oven.**



AT REGULAR INTERVALS, especially if spills have occurred, remove the turntable, the turntable support and wipe the base of the oven clean.



THIS OVEN IS DESIGNED to operate with the turntable in place.

 **DO NOT** operate the microwave oven when the turntable has been removed for cleaning.

USE A MILD DETERGENT, water and a soft cloth to clean the interior surfaces, front and rear of the door and the door opening.

 **DO NOT ALLOW GREASE** or food particles to build up around the door.

FOR STUBBORN STAINS, boil a cup of water in the oven for 2 or 3 minutes. Steam will soften the marks.

 **DO NOT USE STEAM CLEANING APPLIANCES** when cleaning your microwave oven.

ADDING SOME LEMON JUICE to a cup of water, placing this on the turntable and boiling for a few minutes can eliminate odors inside the oven.

THE GRILL ELEMENT does not need cleaning since the intense heat will burn off any splashes, but the cavity ceiling below it may need regular cleaning. This should be done with warm water, detergent and a sponge. If the Grill is not used regularly, it should be run for 10 minutes a month to burn off any splashes, in order to reduce the risk of fire.

DISHWASHER SAFE:

TURNTABLE SUPPORT.

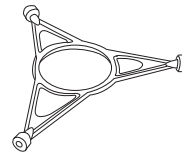

GLASS TURNTABLE.



WIRE RACK.

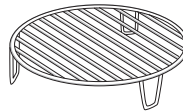

TROUBLE SHOOTING GUIDE

IF THE OVEN DOES NOT WORK, do not make a service call until you have made the following checks:

- ❏ The Turntable and turntable support is in place.
- ❏ The Plug is properly inserted in the wall socket.
- ❏ The Door is properly closed.
- ❏ Check your Fuses and ensure that there is power available.
- ❏ Check that the oven has ample ventilation.
- ❏ Wait for 10 minutes, then try to operate the oven once more.
- ❏ Open and then close the door before you try again.

THIS IS TO AVOID unnecessary calls for which you will be charged.

When calling for Service, please give the serial number and type number of the oven (see Service label). Consult your warranty booklet for further advice.



IF THE MAINS CORD NEEDS REPLACING it should be replaced by the original mains cord, which is available via our service organization. The mains cord may only be replaced by a trained service technician.



SERVICE ONLY TO BE CARRIED OUT BY A TRAINED SERVICE TECHNICIAN. It is hazardous for anyone other than a trained person to carry out any service or repair operation, which involves the removal of any cover, which gives protection against exposure to microwave energy.

DO NOT REMOVE ANY COVER.



DATA FOR TEST HEATING PERFORMANCE

IN ACCORDANCE WITH IEC 60705.

THE INTERNATIONAL ELECTROTECHNICAL COMMISSION has developed a standard for comparative testing of heating performance of different microwave ovens. We recommend the following for this oven:

Test	Amount	Approx. time	Power level	Container
12.3.1	1000 g	13 - 14 min	650 W	Pyrex 3.227
12.3.2	475 g	5 min	800 W	Pyrex 3.827
12.3.3	900 g	13 - 14 min	800 W	Pyrex 3.838
13.3	500 g	10 min	160 W	

TECHNICAL SPECIFICATION

SUPPLY VOLTAGE	230 V/50 Hz
RATED POWER INPUT	2300 W
FUSE	10 A
MW OUTPUT POWER	1000 W
GRILL	800 W
OUTER DIMENSIONS (HxWxD)	385 x 595 x 468
INNER DIMENSIONS (HxWxD)	200 x 405 x 380

Three horizontal light blue lines for writing.



Twenty horizontal light blue lines for writing, stacked vertically.

Three horizontal light blue lines for writing.



Twenty horizontal light blue lines for writing, stacked vertically.

ENVIRONMENTAL HINTS

THE PACKING BOX may be fully recycled as confirmed by the recycling symbol. Follow local disposal regulations. Keep potentially hazardous packaging (plastic bags, polystyrene etc.) out of the reach of children.

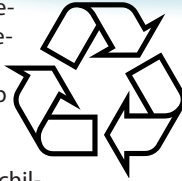

THIS APPLIANCE is marked according to the European directive 2002/96/EC on Waste Electrical and Electronic Equipment (WEEE). By ensuring this product is disposed of correctly, you will help prevent potential negative consequences for the environment and human health, which could otherwise be caused by inappropriate waste handling of this product.

THE SYMBOL on the product, or on the documents accompanying the product, indicates that this appliance may not be treated as household waste. Instead it shall be handed over to the applicable collection point for the recycling of electrical and electronic equipment.

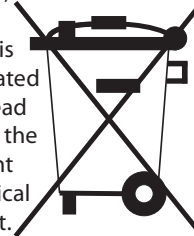

DISPOSAL must be carried out in accordance with local environmental regulations for waste disposal.

FOR MORE DETAILED INFORMATION about treatment, recovery and recycling of this product, please contact your local city office, your household waste disposal service or the shop where you purchased the product.

BEFORE SCRAPPING, cut off the mains cord so that the appliance cannot be connected to the mains.





4 6 1 9 - 6 9 4 - 7 3 7 4 1

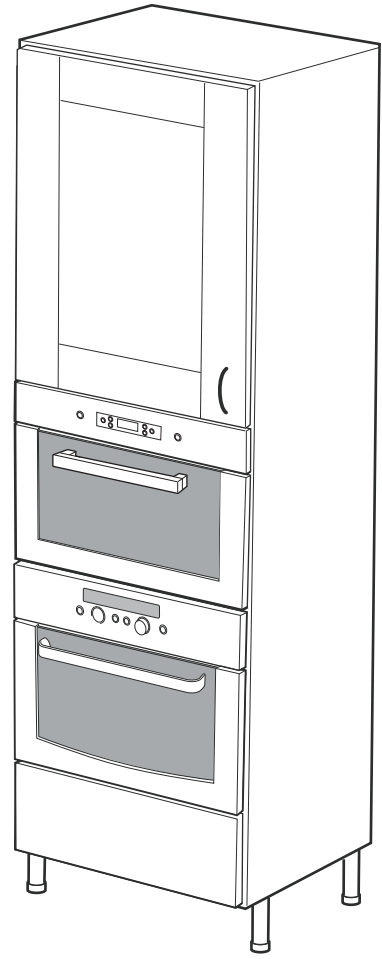
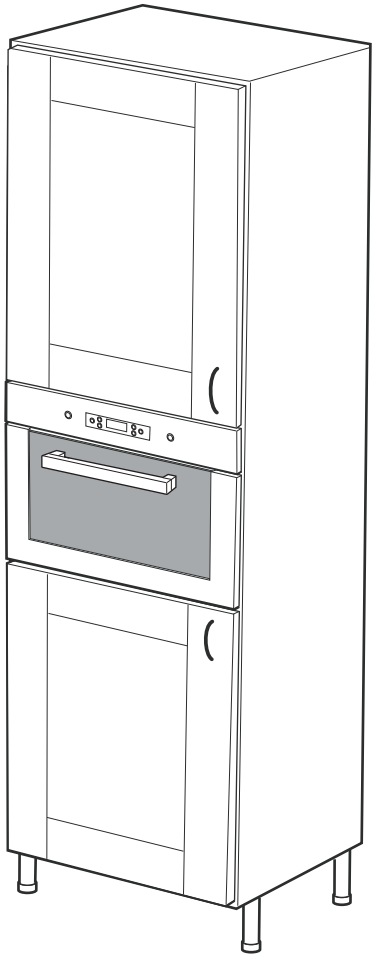

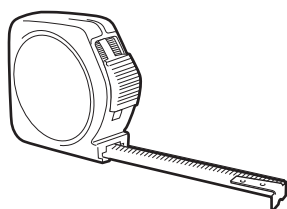
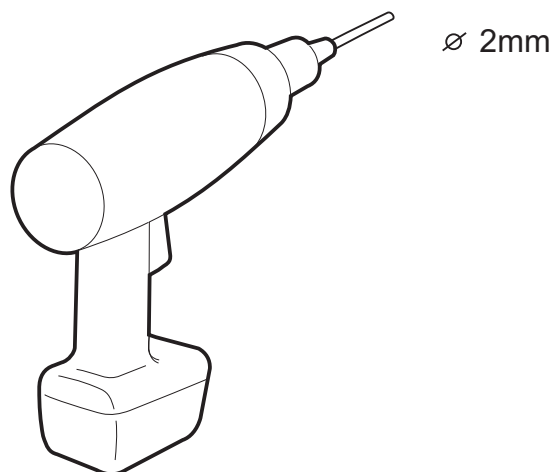
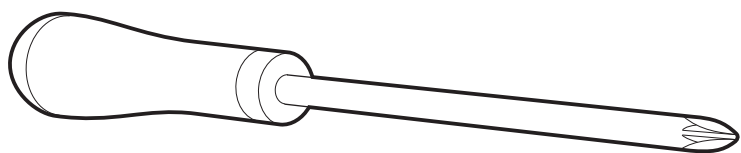



C  X 2

C  X 2

1

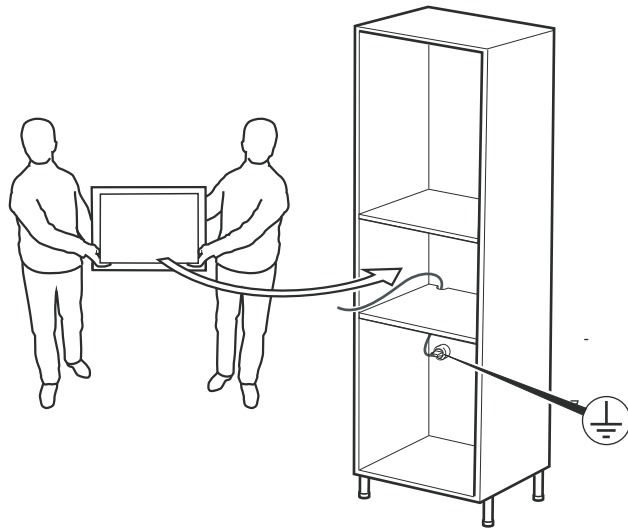
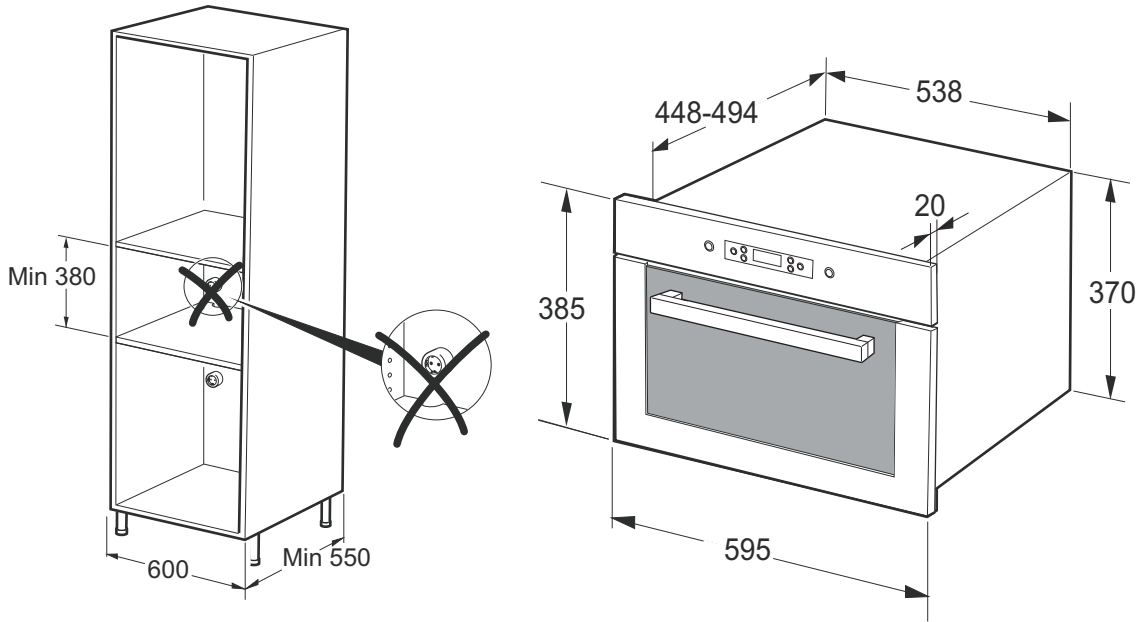

2

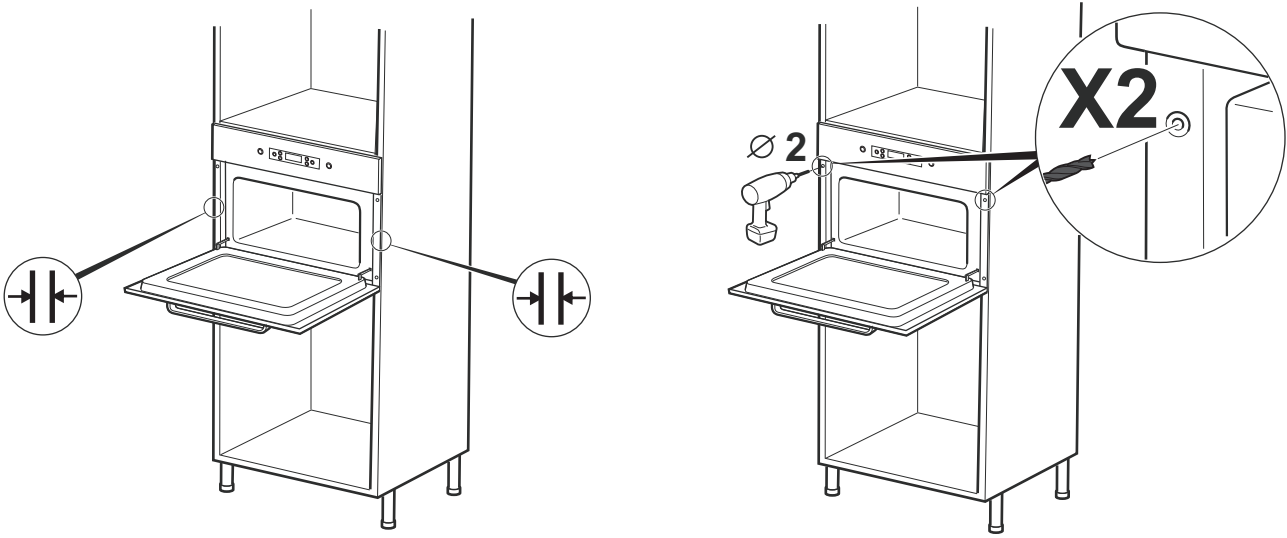

3

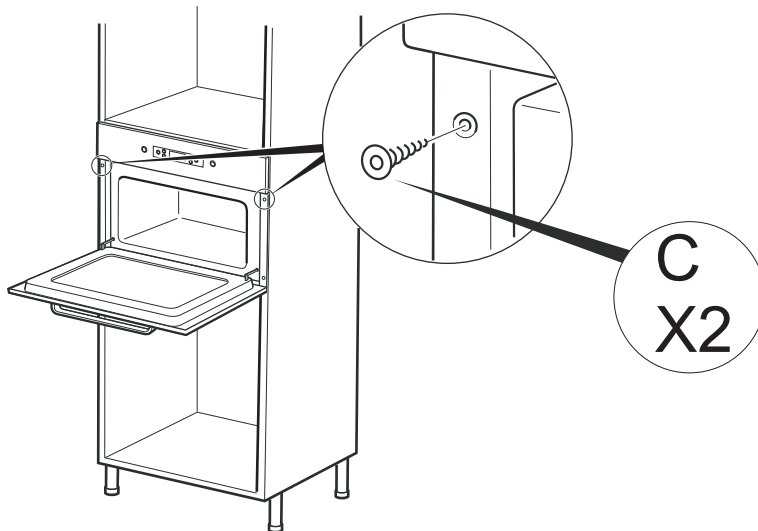

4619-694-70061