

Canon

SPEEDLITE
430EX

English

Thank you for purchasing a Canon product.

The Canon Speedlite 430EX is a multi-feature flash unit for Canon EOS cameras. It works automatically with E-TTL II, E-TTL, and TTL autoflash systems. It can be used as an on-camera flash or as part of a wireless flash system.

- **Read this instruction manual while also referring to your camera's instruction manual.**

Before using the Speedlite, read this instruction manual and your camera's instruction manual to familiarize yourself with the Speedlite operations.

- **The basic operation is the same as with normal AE shooting.**

When the 430EX is attached to an EOS camera, **almost all automatic exposure control for flash photography is handled by the camera.**

Although the 430EX is an external flash unit, it works automatically and seamlessly like the camera's built-in flash.

- **It is automatically compatible with the camera's flash metering mode (E-TTL II, E-TTL, and TTL).**

The camera controls the Speedlite automatically in the following flash metering modes:

1. E-TTL II autoflash (evaluative flash metering with preflash reading/lens distance information)
2. E-TTL autoflash (evaluative flash metering with preflash reading)
3. TTL autoflash (off-the-film metering for real-time flash metering)

Regarding the camera's available flash metering modes, refer to the "External Speedlite" specification in the "Specifications" of your camera's instruction manual. The Speedlite's major specifications are listed in "External Flash Items."

The camera instruction manual's chapter on flash photography will refer to cameras having **1 and 2 as a Type-A camera** (compatible with E-TTL II or E-TTL). And cameras having **3** (compatible with only TTL) **are called Type-B cameras.**

* This instruction manual assume that you are using the 430EX with a Type-A camera.

For Type-B cameras, see page 35.

Contents

1	Getting Started and Basic Operation	7
2	Using Flash	13
3	Wireless Flash	23
	Reference	30

Conventions Used in this Manual

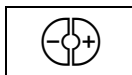

- The <+/-> symbol in the text refers to the +/- button.





- The <Select/Set> symbol in the text refers to the Select/Set button.

- The operation procedures in this instruction manual assume that both the camera and Speedlite's power switches are ON.
- Icons are used in the text to indicate the respective buttons, dials, and settings. They match the same icons found on the camera and Speedlite.
- The (8) / (12) icons indicate that the respective function remains in effect for 8 sec. or 12 sec.
- Reference page numbers are indicated by (p.**).
- This instruction manual uses the following alert symbols:
 - ⚠ : The Caution symbol indicates a warning to prevent shooting problems.
 - 📄 : The Note symbol gives supplemental information.

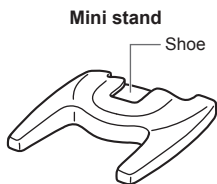
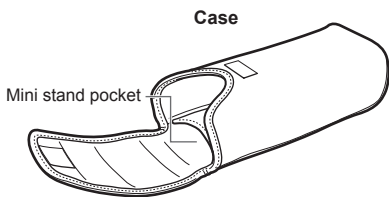
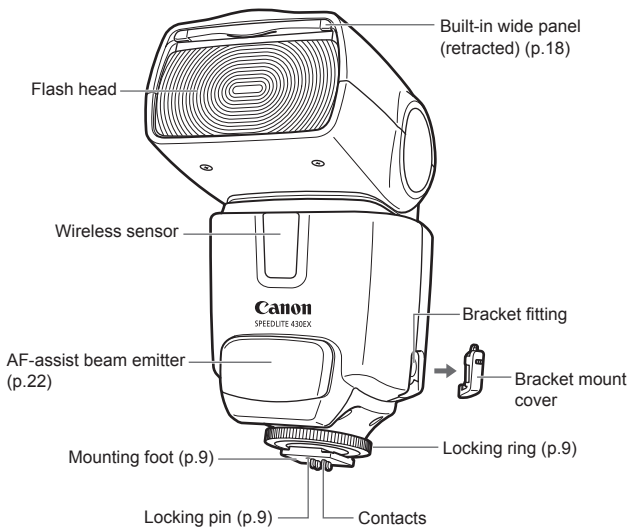
Nomenclature

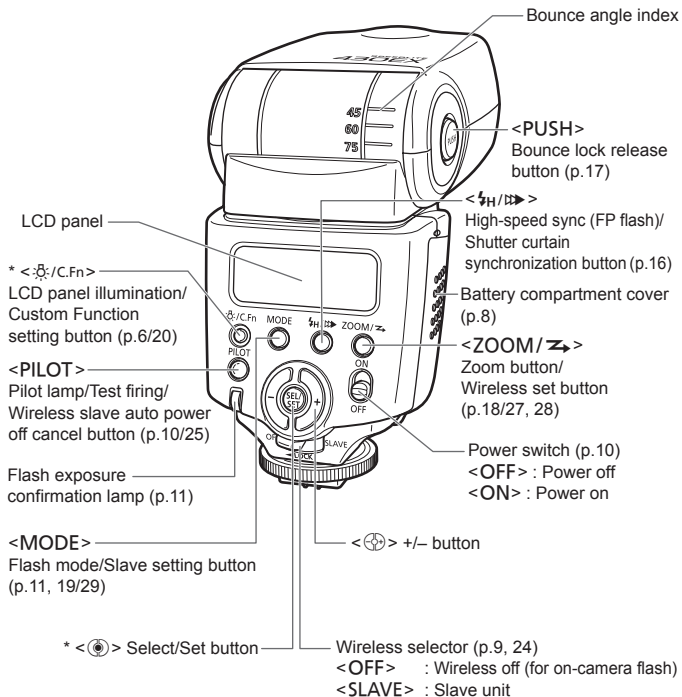



 Asterisked buttons have a timer that keeps the button's function active for 8 sec. (⌚) after you let go of the button. The  illumination lasts for 12 sec.

LCD Panel

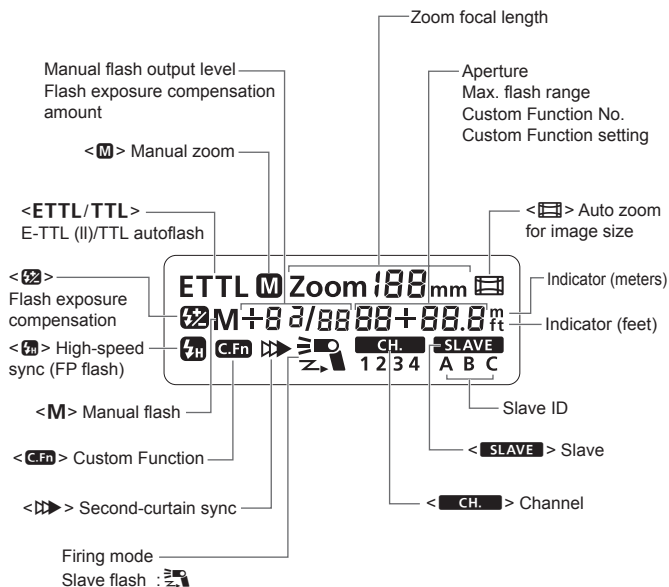

- To illuminate the LCD panel, press the <[Light Icon]> button.
- The items actually displayed depend on the current settings.

1

Getting Started and Basic Operation

Installing Batteries	8
Attaching to the Camera.....	9
Turn on the Power Switch	10
Fully Automatic Flash Shooting.....	11
Using E-TTL II and E-TTL Autoflash in the Shooting Modes.....	12



To avoid overheating and deteriorating the flash head, do not fire rapid bursts of more than 20 continuous flashes. After 20 continuous flashes, allow a rest time of at least 10 min.

Installing Batteries

Install four size-AA batteries.

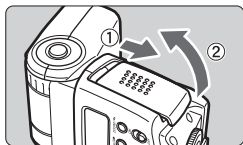

1 Open the cover.

- Slide the battery compartment cover as shown by the arrow and open it.

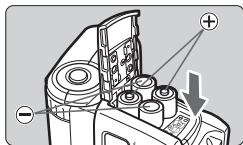

2 Install the batteries.

- Make sure the + and – battery contacts are correctly oriented as shown in the battery compartment.

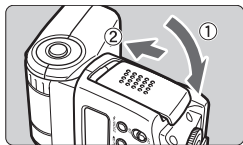

3 Close the cover.

- Close the battery compartment cover and slide it as shown by the arrow.

Recycling Time and Flash Count (with size-AA alkaline batteries)

Recycling Time (Approx.)	Flash Count (Approx.)
Normal Flash	
0.1 - 3.7 sec.	200 - 1400

- Based on new size-AA alkaline batteries and Canon's testing standards.



Since the shape of their contacts is not standardized, using non-alkaline size-AA batteries may result in faulty battery connection.



- Use four new batteries of the same brand and type. Do not mix battery types. When replacing batteries, replace all four batteries at the same time.
- Size-AA Ni-MH or lithium batteries can also be used.

Attaching to the Camera

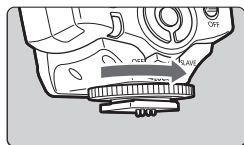

1 Loosen the locking ring.

- Turn the locking ring as shown by the arrow to loosen it.

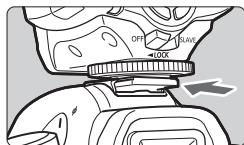

2 Attach it to the camera.

- Slip the Speedlite's mounting foot all the way into the hot shoe.



3 Tighten.

- Turn the locking ring as shown by the arrow. The locking pin will protrude from the mounting foot to further secure the attachment.
- To detach the Speedlite, loosen the locking ring until the locking pin disengages. Then slip the Speedlite out of the hot shoe.



Before attaching or detaching the Speedlite, be sure to turn off the Speedlite.

Wireless Selector Settings

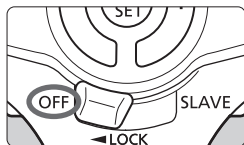

The wireless selector is for switching between normal flash shooting and wireless flash shooting.

For normal flash shooting, be sure to set the wireless selector to <OFF>.

Turn on the Power Switch

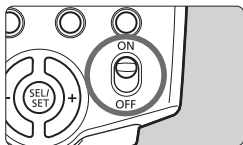

- 1 Set the power switch to <ON>.**
 - ▶ The flash will start recycling.

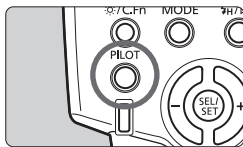

- 2 Check that the flash is ready.**
 - When the pilot lamp lights in red, the flash is ready to fire.
 - To fire a test flash, press the pilot lamp.

About Auto Power Off

To save battery power, the power will turn off automatically after 90 sec. of idle use. To turn on the Speedlite again, press the shutter button halfway. Or press the Speedlite's test firing button.



- A test firing cannot be fired while the camera's operation timer $\odot 4$ or $\odot 6$ is active.
- The Speedlite's settings will be retained in memory even after the power is turned off. To retain the Speedlite's settings when you replace the batteries, replace the batteries within 1 minute after turning off the power.

Fully Automatic Flash Shooting

When you set the camera's shooting mode to <P> (Program AE) or <□> (Full Auto), E-TTL II/E-TTL fully automatic flash will make it as easy as normal AE shooting.

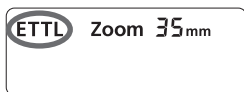

1 Set the Speedlite to <ETTL>.

- Press the <MODE> button so that <ETTL> is displayed.



2 Focus the subject.

- Press the shutter button halfway to focus.
 - ▶ The shutter speed and aperture will be set as displayed in the viewfinder.
- Check that the <⚡> icon is lit in the viewfinder.

3 Take the picture.

- Take the picture.
 - ▶ A preflash is fired right before the shot is taken, then the main flash is fired.
 - ▶ If a standard flash exposure was obtained, the flash exposure confirmation lamp will light for about 3 sec.

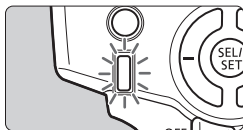

If the lens focal length blinks on the LCD panel, the periphery of the flash picture may turn out dark. Use the built-in wide panel (p.18).



- <ETTL> will be displayed on the LCD panel even if the camera is compatible with E-TTL II.
- If the flash exposure confirmation lamp does not light, move closer to the subject and take the picture again. With a digital camera, you can also increase the camera's ISO speed.

Using E-TTL II and E-TTL Autoflash in the Shooting Modes ■

Just set the camera's shooting mode to <Av> (aperture-priority AE), <Tv> (shutter-priority AE), or <M> (manual) and you can use E-TTL II/E-TTL autofocus.

Tv	Select this mode when you want to set the shutter speed manually. The camera will then automatically set the aperture matching the shutter speed to obtain a standard exposure. <ul style="list-style-type: none">● If the aperture display blinks, it means that the background exposure will be underexposed or overexposed. Adjust the shutter speed until the aperture display stops blinking.
Av	Select this mode when you want to set the aperture manually. The camera will then automatically set the shutter speed matching the aperture to obtain a standard exposure. If the background is dark like a night scene, a slow sync speed will be used to obtain a standard exposure of both the main subject and background. Standard exposure of the main subject is obtained with the flash, while a standard exposure of the background is obtained with a slow shutter speed. <ul style="list-style-type: none">● Since a slow shutter speed will be used for low-light scenes, using a tripod is recommended.● If the shutter speed display blinks, it means that the background exposure will be underexposed or overexposed. Adjust the aperture until the shutter speed display stops blinking.
M	Select this mode when you want to set both the shutter speed and aperture manually. Standard exposure of the main subject is obtained with the flash. The exposure of the background is obtained with the shutter speed and aperture combination you set.

- If you use the <DEP> or <A-DEP> shooting mode, the result will be the same as using the <P> (Program AE) mode.



Flash Sync Speeds and Apertures Used

	Shutter Speed Setting	Aperture Setting
P	Automatic (1/60 sec. - 1/X sec.)	Automatic
Tv	Manual (30 sec. - 1/X sec.)	Automatic
Av	Automatic (30 sec. - 1/X sec.)	Manual
M	Manual (buLb, 30 sec. - 1/X sec.)	Manual

- 1/X sec. is the camera's maximum flash sync speed.

2

Using Flash

 Flash Exposure Compensation	14
FE L FE Lock	15
 High-Speed Sync	16
 Second-Curtain Sync	16
Bounce Flash.....	17
ZOOM Setting the Flash Coverage and Using the Wide Panel	18
M Manual Flash	19
C.Fn Setting Custom Functions.....	20
Custom Function Settings	21
About Color Temperature Information Transmission..	22
Reverting to 430EX Default Settings	22
About the AF-Assist Beam	22

Flash Exposure Compensation

You can adjust the flash output as easily as normal exposure compensation. Flash exposure compensation can be set up to ± 3 stops in 1/3-stop increments. (If the camera's exposure compensation is set in 1/2-stop increments, flash exposure compensation is set in 1/2-stop increments.)

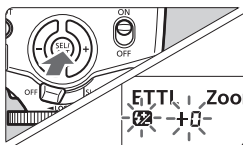

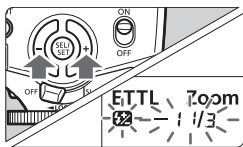

- 1 Press the  button until the  icon and compensation amount start blinking.



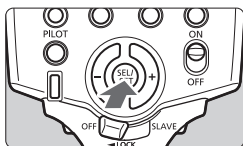

- 2 Set the flash exposure compensation amount.
 - Press the  button to set the amount.
 - To cancel the flash exposure compensation, set the amount to +0.



- 3 Press the  button.
 - ▶ The flash exposure compensation amount will be set.

 If flash exposure compensation has been set with both the Speedlite and camera, the Speedlite's flash exposure compensation amount will override the camera's.

Using >

This is for setting various numeric settings. Pressing the  (plus) button increases the number, while the  (minus) button decreases the number.

FEL FE Lock

FE (flash exposure) lock enables you to lock the correct flash exposure for any part of the picture.

With **<ETTL>** displayed on the LCD panel, you press the camera's **<FEL>** button. If the camera does not have the **<FEL>** button, press the **<★>** button.

1 Focus the subject.

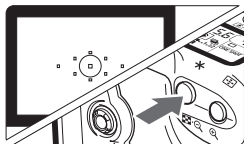

2 Press the **<FEL>** button. (ⓘ16)

- Aim the viewfinder center over the subject and press the **<FEL>** button.
- ▶ A preflash will be fired to obtain a flash exposure reading for the subject.
- ▶ “**FEL**” will be displayed on the LCD panel for 0.5 sec.
- Each time you press the **<FEL>** button, a preflash will be fired and a new flash exposure reading will be locked.





- If the subject is too far away and underexposure will result, the **<⚡>** icon will blink in the viewfinder. Move closer to the subject and try the FE lock again.
- If **<ETTL>** is not displayed on the LCD panel, FE lock will not be possible.
- If the subject is too small, FE lock might not be very effective.

High-Speed Sync

With high-speed sync, you can use flash with all shutter speeds. This is convenient when you want to use aperture priority for fill-flash portraits.



ETTL Zoom 50mm



Press the  button so that  is displayed.

- Check that the  icon is lit in the viewfinder.



- If you set a shutter speed that is the same or slower than the camera's maximum flash sync speed,  will not be displayed in the viewfinder.
- With high-speed sync, the faster the shutter speed, the shorter the effective flash range will be. Check the LCD panel for the maximum flash range for the respective shutter speed.
- To return to normal flash, press the  button so that  icon turns off.

Second-Curtain Sync



With a slow shutter speed, you can create a light trail following the subject. The flash fires right before the shutter closes.

ETTL Zoom 50mm



Press the  button so that  is displayed.



- Setting the shooting mode to “buLb” will make it easier for second-curtain sync.
- To return to normal flash, press the  button so that the  icon turns off.
- With E-TTL II/E-TTL, the flash will fire twice even with a slow sync speed. The first flash is the preflash.

Bounce Flash

By pointing the flash head toward a wall or ceiling, the flash will bounce off the surface before illuminating the subject. This can soften shadows behind the subject for a more natural-looking shot. This is called bounce flash.

Set the Bounce Direction

Hold down the <PUSH> button and turn the flash head.

If the flash coverage is set automatically, the flash coverage will be set to 50mm.

The LCD panel will also display <- -> mm. (p.18)

- You can also set the flash coverage manually.

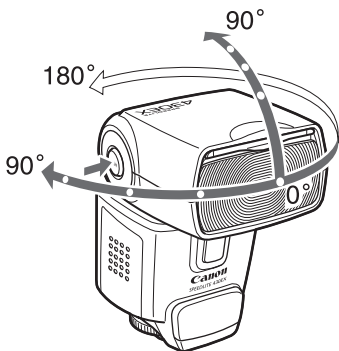

- If the wall or ceiling is too far away, the bounced flash might be too weak and result in underexposure.
- The wall or ceiling should be a plain, white color for high reflectance. If the bounce surface is not white, a color cast may result in the picture.
- After you take the shot, if the flash exposure confirmation lamp does not light, use a larger aperture opening and try again. With a digital camera, you can also increase the ISO speed.

ZOOM Setting the Flash Coverage and Using the Wide Panel

The flash coverage can be set to match the lens focal length from 24mm to 105mm. The flash coverage can be set automatically or manually. Also, with the built-in wide panel, the flash coverage will be compatible with ultra wide-angle lenses as short as 14mm.

ETTL **M** Zoom 24mm

Press the <ZOOM/ > button.

- Press the < > button to change the flash coverage.
- When the flash coverage is set automatically, <**M**> is not displayed.



If you set the flash coverage manually, make sure it covers the lens focal length so that the picture will not have a dark periphery.

Using the Wide Panel

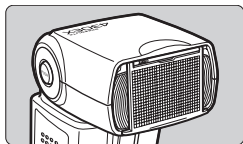

Pull out the wide panel and place it over the flash head as shown.

- The <ZOOM/  > button will not work.



- The flash coverage will not be compatible with the EF15mm f/2.8 Fisheye lens.
- For the effective lens focal length (or crop factor), refer to the camera's instruction manual.



- If you use bounce flash with the wide panel in place, the entire display on the LCD panel will blink as a warning. Since the subject will be illuminated by both the bounce flash and direct flash, it will look unnatural.
- Pull out the wide panel gently. Using excessive force may detach the wide panel.

M Manual Flash

You can set the flash output from 1/64 power to 1/1 full power in full-stop increments.

Use a hand-held flash meter to determine the required flash output to obtain a correct flash exposure. Be sure to first set the camera's shooting mode to <Av> or <M>.

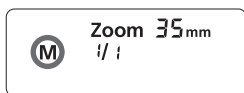

- 1 Press the <MODE> button so that <M> is displayed.

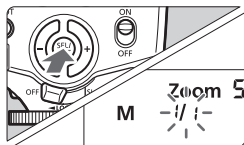

- 2 Set the flash output.

- Press the <FLASH> button.
- ▶ The flash output display will blink.
- Press the <FLASH> button to set the flash output, then press the <MODE> button.
- Press the shutter button halfway to see the effective flash range displayed.

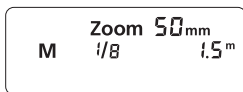

C.Fn Setting Custom Functions

You can customize Speedlite features to suit your preferences. Do it with Custom Functions.



1 Press the <:C.Fn> button for 2 sec. so that <C.Fn> is displayed.

2 Select the Custom Function No.

- Press the <+> button to select the Custom Function number.

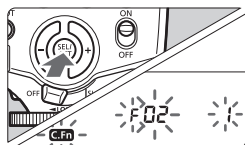

3 Change the setting.

- Press the <0> button.
 - ▶ The Custom Function number and setting number will blink.
 - ▶ Press the <+> button to select "0" or "1", then press the <0> button.
 - ▶ After you set the Custom Function and press the <MODE> button, the camera will be ready to shoot.



Changing Meters or Feet

After step 1 above, press the <0> button for at least 2 sec. When the distance display blinks, press the <+> button to switch between meters and feet. Then press the <0> button.

Custom Function Settings

Custom Function No.	Item	Setting No.	Setting Description
C.Fn-01	Auto Power Off activation	0	ON
		1	OFF
C.Fn-02	Slave unit's auto power off time	0	Auto power off after 60 min.
		1	Auto power off after 10 min.
C.Fn-03	Auto zoom for image size	0	Enabled
		1	Disabled
C.Fn-04	AF-assist beam OFF	0	Disabled
		1	Enabled
C.Fn-05	Modeling flash	0	Enabled
		1	Disabled
C.Fn-06	LCD panel display when shutter button pressed halfway	0	Display maximum flash range. (Displays up to max. 18 m/60 ft)
		1	Display aperture.

C.Fn-05-1: Convenient when you want to check the depth of field. (p.28)



- C.Fn-06 can be set only with Type-A cameras.
- If "AF-assist beam OFF" is set with the Speedlite or camera, the AF-assist beam will not be emitted.

Automatic Setting of Flash Coverage for the Camera's Image Size

EOS digital cameras have one of three image sizes. The lens' effective focal length will differ depending on the camera's image size. The Speedlite automatically recognizes the EOS digital camera's image size and automatically sets the flash coverage for lens focal lengths from 24mm to 105mm.

When the Speedlite is attached to a compatible camera, <  > will appear on the Speedlite's LCD panel.

ETTL Zoom 35mm 

About Color Temperature Information Transmission

When the flash fires, the color temperature information is transmitted to certain specific EOS digital camera. This feature optimizes the flash picture's white balance. When the camera's color balance is set to <AWB> or <⚡>, it will work automatically.

To see if this feature works with your camera, see the "White Balance" specification in the "Specifications" of your camera's instruction manual.

Reverting to 430EX Default Settings

When 430EX is attached to an EOS camera equipped with a <CLEAR> button, you can press it to revert the 430EX's settings (except Custom Functions) to the default.

About the AF-Assist Beam

Under low-light or low-contrast conditions, the built-in AF-assist beam will be emitted automatically to make it easier to autofocus. The 430EX's AF-assist beam is compatible with the AF points of almost all EOS cameras. The AF-assist beam is compatible with 28mm and longer lenses. The effective range is shown below.

Position	Effective Range (m / ft)
Center	Approx. 0.7 - 10 / 2.3 - 32.8
Periphery	Approx. 0.7 - 5 / 2.3 - 16.4

3

Wireless Flash

Wireless Flash	24
Setting Manual Flash with the Slave Unit	29

Wireless Flash

With multiple Canon Speedlites having the wireless flash feature, you can create various lighting effects with the same ease as using normal E-TTL II autoflash.

The settings you input with the master unit attached to the camera are also transmitted to the slave unit(s) controlled by wireless. Therefore, you need not operate the slave unit(s) at all during the shoot.

For details on wireless flash photography and operating the master unit, see the master unit's instruction manual. The procedure below applies to a master unit attached to the camera and slave unit(s) controlled by wireless.

1 Set the master unit.

- Attach Speedlite 580EX, 550EX, ST-E2, MR-14EX or MT-24EX to the camera and set it as necessary.

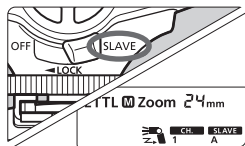

2 Set the 430EX as the slave unit.

- Set the wireless selector to <SLAVE>.

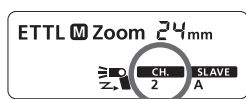

3 Check the communication channel.

- If the master unit and slave unit(s) are set to a different channel, set them all to the same channel (p.27).

4 Set the slave ID.

- Set the slave ID when using two (A and B) or three (A, B, and C) slave groups (p.28).

5 Position the camera and Speedlites as desired.

- Position the slave unit(s) within the master unit's wireless transmission range.

6 Set the master unit's flash mode to <ETTL>.

- The slave unit(s) will also be automatically set to <ETTL>.

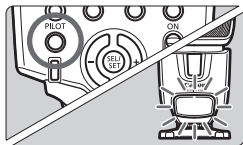

7 Check that the flash is ready.

- When the slave unit is ready to fire, the AF-assist beam will blink once each second.

8 Check the flash operation.

- Press the master unit's test firing button.
- ▶ The slave unit will fire. If the flash does not fire, adjust the slave unit's angle toward the master unit and distance from the master unit.

9 Set the camera and shoot.

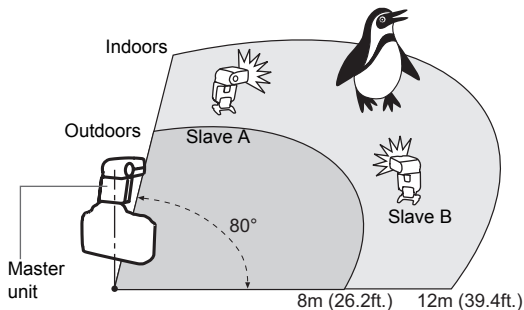

- Set the camera in the same way as with normal flash shooting.

Sample wireless flash setup



- Use the mini stand (tripod socket provided) to prop up the slave unit.
- Use the bounce feature to swing the slave unit's flash body so that the wireless sensor faces the master unit.
- Indoors, the wireless signal may also bounce off the wall so there is more leeway in positioning the slave unit(s).
- After positioning the slave unit(s), be sure to test the wireless operation before shooting.
- Do not place any obstacles between the master unit and slave unit(s). Obstacles can block the transmission of wireless signals.



- Even with multiple slave units, all of them will be controlled in the same way via wireless.
- The Speedlite's zoom setting will be set automatically to 24mm. It is possible to change the master unit's zoom setting. However, note that the master unit transmits wireless signals to the slave unit(s) with the preflash. Therefore, the flash coverage must cover the slave unit's position. If you change the master unit's zoom setting, be sure to test the wireless operation before shooting.
- If the slave unit enters auto power off, it can be turned on again by pressing the master unit's test firing button.
- If the 430EX is set as a slave unit and remains in auto power off mode for more than 8 hours, it will not turn on even if you try to fire a test flash with the master unit. In this case, press the slave unit's test firing button to turn it on.
- A test flash cannot be fired while the camera's operation timer 4 or 6 is active.

Using Fully Automatic Wireless Flash

Flash exposure compensation and other settings set with the master unit will also be automatically set in the slave units. Thus, you need not make settings on the slave unit(s). Wireless flash with the following settings can be done in the same way as with normal flash shooting.

- Flash exposure compensation
- FEB
- High-speed sync (FP flash)
- Manual flash
- FE lock
- Stroboscopic flash



- With FE lock, if even one Speedlite will result in underexposure, the <⚡> icon will blink in the viewfinder. Open the aperture more or move the slave unit closer to the subject.
- With a wireless flash system, the master unit's settings will not be displayed on the 430EX's LCD panel.

Setting Communication Channel

If there is another Canon wireless flash system nearby, you can change the channel No. to prevent signal confusion. Both the master and slave units must be set to the same channel No.

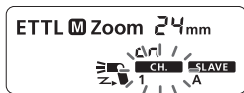

- 1 Press the <ZOOM/↔> button so that <CH. > blinks.

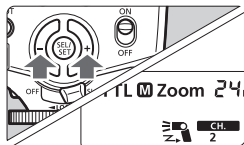

- 2 Set the channel No.
 - Press the <SEL> button to select the number, then press the <OK> button.

Setting the Slave ID

Set the slave ID if you use two (A and B) or three (A, B, and C) slave groups.

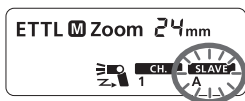

- 1 Press the **<ZOOM/ Z>** button so that **<SLAVE>** blinks.
- 2 Press the **<+>** button to select the slave ID (A, B, or C).
- 3 Press the **<->** button to set the slave ID.

Modeling Flash

If the camera has a depth-of-field preview button, press it to fire a 1-sec. burst of flashes. This is the modeling flash.

You can check the lighting and shadow effects. You can fire the modeling flash for both wireless and normal flash shooting.

Do not fire the modeling flash more than 10 consecutive times. If you fire the modeling flash 10 consecutive times, allow the Speedlite to rest for at least 10 min. to avoid overheating and deteriorating the flash head.

The modeling flash cannot be fired with the EOS 300/REBEL 2000 and Type-B cameras (p.2).

About Slave Group Control

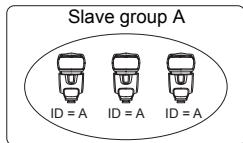

For example, if you have the slave ID set to **<A>** for three Speedlites, all three Speedlites will be controlled as if they were one Speedlite in slave group A.

Setting Manual Flash with the Slave Unit

Manual flash can be set manually with the slave unit. Do this in the following cases:

- (1) When you want to set the flash output with the slave units individually for wireless or manual flash, as with studio flash units.
- (2) When you use Speedlite Transmitter ST-E2 for wireless or manual flash.

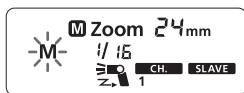

- Press the <MODE> button for 2 sec.
- ▶ <M> will blink.
- Set the manual flash output (p.19).

Reference

430EX System

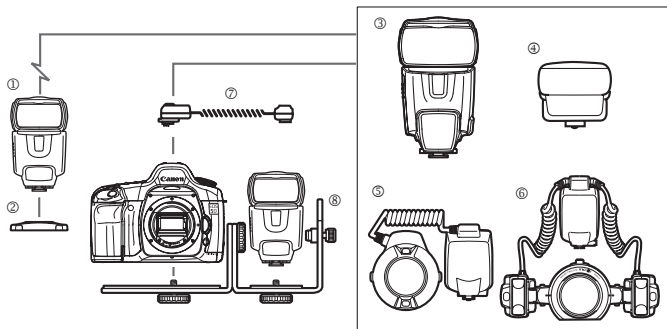

- ① **Speedlite 430EX** (Slave unit)
- ② **Mini stand** (included with 430EX)
- ③ **Speedlite 580EX** (On-camera/Master unit)
- ④ **Speedlite Transmitter ST-E2**
Dedicated transmitter for wireless control of 430EX set as slave units.
- ⑤ **Macro Ring Lite MR-14EX** / ⑥ **Macro Twin Lite MT-24EX**
Flash for macro photography. Compatible with wireless flash and it can be used together with the 430EX slave unit.
- ⑦ **Off-Camera Shoe Cord 2**
Enables the 430EX to be connected to the camera up to 60 cm/2 ft away. All of the EOS camera's automatic functions can be used.
- ⑧ **Speedlite Bracket SB-E1**
The SB-E1 is not available in all countries.

Troubleshooting

Have a problem? See the table below.

The Speedlite does not detach from the camera.

- **The mounting foot's locking pin has not been retracted.**
 - ▶ Loosen the locking ring all the way before detaching the Speedlite. (p.9)

The Speedlite does not fire.

- **The batteries are installed in the wrong orientation.**
 - ▶ Install the batteries in the correct orientation. (p.8)
- **The Speedlite's internal batteries are exhausted.**
 - ▶ If the flash recycling time is 30 sec. or longer, replace the batteries. (p.8)
- **Attach the Speedlite securely to the camera.**
 - ▶ Attach the Speedlite's mounting foot securely to the camera. (p.9)
- **The electrical contacts of the Speedlite and camera are dirty.**
 - ▶ Clean the contacts. (p.9)

The slave unit does not fire.

- **The slave's wireless selector is not set to <SLAVE>.**
 - ▶ Set it to <SLAVE>. (p.24)
- **The slave unit is not positioned properly.**
 - ▶ Place the slave unit within the master unit's transmission range. (p.26)
 - ▶ Point the slave unit's sensor toward the master unit. (p.26)

The power turns off by itself.

- **After 90 sec. of idle operation, auto power off took effect.**
 - ▶ Press the shutter button halfway or press the test firing button. (p.10)

The entire LCD panel blinks.

- **The wide panel has been pulled out for bounce flash.**
 - ▶ Retract the wide panel. (p.18)

The periphery or bottom of the picture looks dark.

- **When you set the flash coverage manually, the setting was a higher number than the lens focal length, resulting in a dark periphery.**
 - ▶ Set the flash coverage that is a lower number than the lens focal length or set it to auto zoom. (p.18)
- **If only the bottom of the picture looks dark, you were too close to the subject.**
 - ▶ Keep at least 0.7 m/2.3 ft away from the subject.

The flash exposure is underexposed or overexposed.

- **There was a highly reflective object (glass window, etc.) in the picture.**
 - ▶ Use FE lock. (p.15)
- **The subject has a very dark or light color.**
 - ▶ Set flash exposure compensation. For a dark subject, set a decreased flash exposure. And for a bright subject, set an increased flash exposure. (p.14)
- **You used high-speed sync.**
 - ▶ With high-speed sync, the effective flash range will be shorter. Make sure the subject is within the effective flash range displayed. (p.16)

The picture is really blurred.

- **The shooting mode was set to <Av>, and the scene was dark.**
 - ▶ Use a tripod or set the shooting mode to <P>. (p.12)

Specifications

• Type

Type:	On-camera, E-TTL II/E-TTL/TTL autoflash Speedlite
Compatible cameras:	Type-A EOS cameras (E-TTL II/E-TTL autoflash), Type-B EOS cameras (TTL autoflash)
Guide No.:	43/141 (at 105mm focal length, ISO 100 in meters/feet)
Flash coverage:	24 - 105mm (14mm with wide panel) <ul style="list-style-type: none">• Auto zoom (flash coverage set automatically for lens focal length and image size)• Manual zoom• Flash head swing (bounce flash)
Flash duration:	Normal flash: 1.2 ms or shorter
Color temperature	
information transmission:	Flash color temperature information transmitted to camera

• Exposure Control

Exposure Control Type:	E-TTL II/E-TTL/TTL autoflash, manual flash
Flash range	
(with EF50mm f/1.4, ISO 100):	Normal flash: Approx. 0.7 - 24.3 m / 2.3 - 79.7 ft High-speed sync: Approx. 0.7 - 12 m / 2.3 - 39.4 ft (at 1/250 sec.)
Flash exposure compensation:	Manual, ± 3 stops in 1/3- or 1/2-stop increments
FE lock:	With <FEL> button or <✳> button
High-speed sync:	Provided
Flash exposure confirmation:	Flash exposure confirmation lamp lights

• Flash Recycling (with size-AA alkaline batteries)

Recycling time/	
Flash-ready indicator:	Normal flash: 3.7 sec. / Red pilot lamp lights

• Wireless Flash

Transmission method:	Optical pulse
Channels:	4
Wireless options:	OFF and Slave
Transmission range	
(Approx.):	Reception angle: $\pm 40^\circ$ horizontal, $\pm 30^\circ$ vertical
Slave-ready indicator:	AF-assist beam blinks
Modeling flash:	Fired with camera's depth-of-field preview button

• Custom Functions: 6 (12 settings)

• AF-Assist Beam

Linkable AF points: 1 - 9 AF points (28mm or longer focal length)

Effective range (Approx.): At center: 0.7 - 10 m / 2.3 - 32.8 ft,

Periphery: 0.7 - 5 m / 2.3 - 16.4 ft

• Power Source

Internal power: Four size-AA alkaline

* Size-AA Ni-MH or lithium batteries also possible

Battery life

(Approx. flash count): 200 - 1400 flashes (with size-AA alkaline batteries)

Power saving: Power off after 90 sec. or idle operation (60 min. if set as slave)

• Dimensions

(W x H x D): 72 x 122 x 101 mm / 2.8 x 4.8 x 4.0 in

• **Weight:** 330 g / 11.6 oz (Speedlite only, excluding batteries)

- All specifications are based on Canon's testing criteria.
- Product specifications and external appearance are subject to change without notice.

Manual Flash Guide No. (GNo.) (ISO 100, in meters/feet)

Flash Output	Flash Coverage (mm)							
	14	24	28	35	50	70	80	105
1/1	11/ 36.1	25/ 82	27/ 88.6	31/ 101.7	34/ 111.5	37/ 121.4	40/ 131.2	43/ 141.1
1/2	7.8/ 25.6	17.7/ 58.1	19.1/ 62.7	21.9/ 71.9	24/ 78.7	26.2/ 86	28.3/ 92.8	30.4/ 99.7
1/4	5.5/ 18	12.5/ 41	13.5/ 44.3	15.5/ 50.9	17/ 55.8	18.5/ 60.7	20/ 65.6	21.5/ 70.5
1/8	3.9/ 12.8	8.8/ 28.9	9.5/ 31.2	11/ 36.1	12/ 39.4	13.1/ 43	14.1/ 46.3	15.2/ 49.9
1/16	2.8/ 9.2	6.3/ 20.7	6.8/ 22.3	7.8/ 25.6	8.5/ 27.9	9.3/ 30.5	10/ 32.8	10.8/ 35.4
1/32	1.9/ 6.2	4.4/ 14.4	4.8/ 15.7	5.5/ 18	6/ 19.7	6.5/ 21.3	7.1/ 23.3	7.6/ 24.9
1/64	1.4/ 4.6	3.1/ 10.2	3.4/ 11.2	3.9/ 12.8	4.3/ 14.1	4.6/ 15.1	5/ 16.4	5.4/ 17.7

Using a Type-B Camera

If you use the 430EX with a Type-B camera (TTL autoflash camera), note the available features and restrictions below.

When a Type-B camera is used with the 430EX set to autoflash, <TTL> will be displayed on the Speedlite's LCD panel.

Features Available with All Type-B Cameras

Configuration	Available Features
On-camera shooting	TTL autoflash
	Flash exposure compensation
	Manual flash
	Second-curtain sync
Wireless flash	Manual flash
	Stroboscopic flash

Features not Available with Any Type-B Cameras

- E-TTL II/E-TTL autoflash
- FE lock
- High-speed sync (FP flash)
- Autoflash with wireless flash
- Flash ratio set with multi-Speedlite wireless flash

Features not Available with Some Type-B Cameras

- EOS 750/850: Stroboscopic flash, second-curtain sync, wireless flash

This device complies with Part 15 of the FCC Rules. Operation is subject to the following two conditions: (1) This device may not cause harmful interference, and (2) this device must accept any interference received, including interference that may cause undesired operation.

Do not make any changes or modifications to the equipment unless otherwise specified in the instructions. If such changes or modifications should be made, you could be required to stop operation of the equipment.

This equipment has been tested and found to comply with the limits for a class B digital device, pursuant to part 15 of the FCC Rules. These limits are designed to provide reasonable protection against harmful interference in a residential installation. This equipment generates, uses and can radiate radio frequency energy and, if not installed and used in accordance with the instructions, may cause harmful interference to radio communications.

However, there is no guarantee that interference will not occur in a particular installation. If this equipment does cause harmful interference to radio or television reception, which can be determined by turning the equipment off and on, the user is encouraged to try to correct the interference by one or more of the following measures:

- Reorient or relocate the receiving antenna.
- Increase the separation between the equipment and receiver.
- Consult the dealer or an experienced radio/TV technician for help.

This Class B digital apparatus complies with Canadian ICES-003.
Cet appareil numérique de la classe B est conforme à la norme NMB-003 du Canada.



This mark indicates that the product complies with Australia's EMC regulations.

Canon

This Instructions booklet is dated July 2005. For information on the camera's compatibility with system accessories marketed after this date, contact your nearest Canon Service Center.