

ROBERTS

Sound for Generations

CR9961

3 Band Single Alarm
Clock Radio



Please read this manual before use

Contents

<i>Contents</i>	2
<i>Controls</i>	3-4
<i>Switching on and setting the time</i>	5
<i>Listening to the radio</i>	6
<i>Setting alarm time</i>	7
<i>Checking alarm time</i>	7
<i>Setting alarm to wake to buzzer</i>	8
<i>Setting alarm to wake to radio</i>	8
<i>Snooze control</i>	9
<i>Sleep timer</i>	9
<i>Headphones</i>	10
<i>Specifications</i>	11
<i>Circuit features</i>	11
<i>General</i>	12
<i>Notes</i>	13-14
<i>Guarantee</i>	15

Controls

(Top)

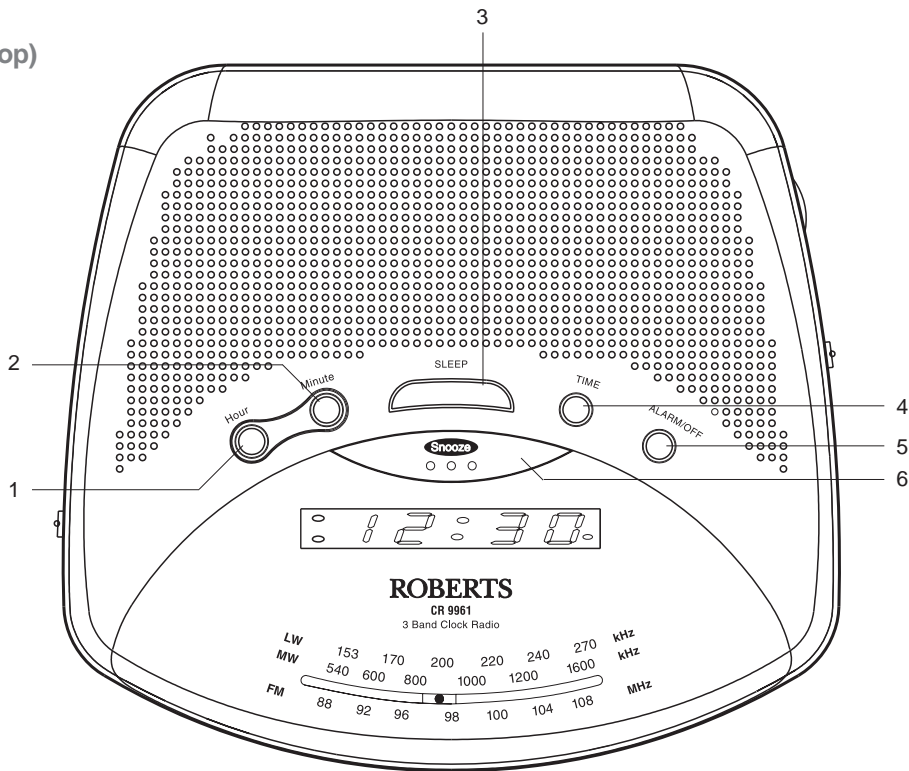

- 1. Hour button
- 2. Minute button
- 3. Sleep button

- 4. Time button
- 5. Alarm off button
- 6. Snooze button

Controls

(Left)

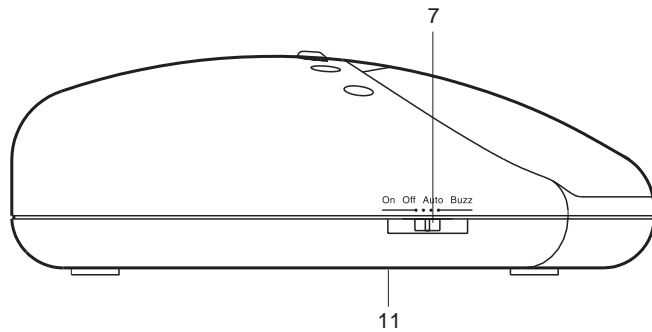

- 7. Function switch
- 8. Tuning control
- 9. Wave Band selector

(Right)

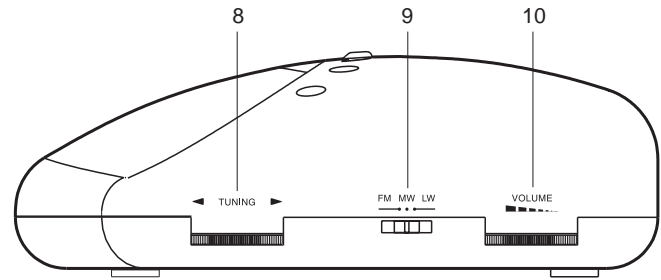

- 10. Volume control
- 11. Back-up battery compartment

Switching on and setting the time

Before using your clock radio you must first set the correct time.

1. Place the unit on a flat surface. Plug the mains lead into a wall socket and switch on the wall socket.
2. The clock display will flash 12:00. Ensure that the Function **switch** is set to the 'Off' position.
3. Press and hold down the **Time button**.
4. Whilst holding down the **Time button** press the **Hour** or **Minute buttons** to set the correct time. Release the buttons when the correct time is reached. The clock uses a 12 hour display with a **PM indicator**. Ensure that the correct 12 hour cycle is selected.

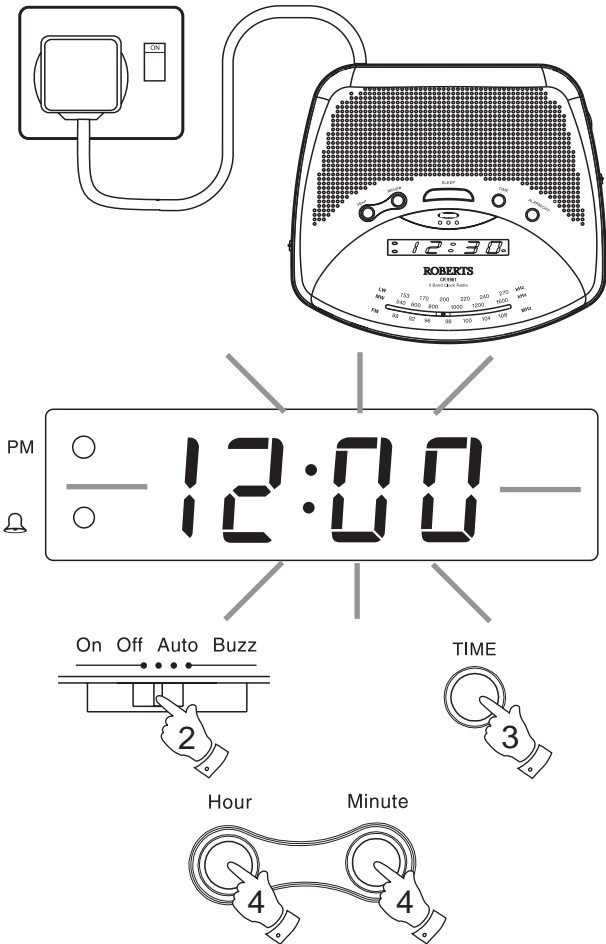

If you need any further advice, please call our Technical Helpline on :-
020 8758 0338 (Mon-Fri)

Listening to the Radio

1. Switch on your clock radio by sliding the **Function switch** to the 'On' position. The **LED dial pointer** will light up indicating that the radio is switched on

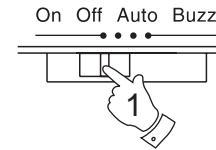

2. Slide the **Waveband switch** to the required waveband.

3. Tune in to the desired station by rotating the **Tuning control**. The station frequency is indicated in the dial scale.

The **Wire aerial** located on the rear of your clock radio is for FM reception. The wire should be fully extended and positioned for optimum reception.

For MW and LW reception there is a built in ferrite aerial. Rotate your clock radio to the position giving best reception.

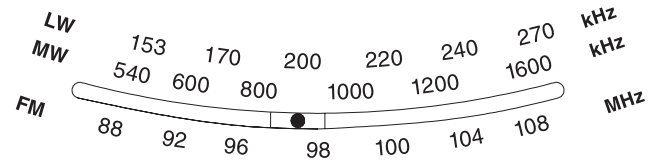

4. Adjust the volume by rotating the **Volume control**.

5. The radio can be switched off by sliding the **Function switch** to the 'Off' position.

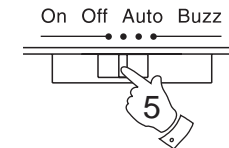
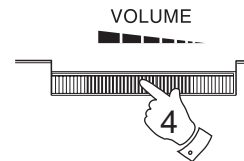
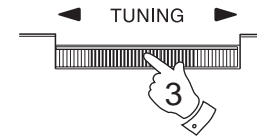
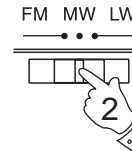

Setting alarm time

The alarm can be set to wake you by either the buzzer or the radio.

1. Press and hold down the **ALARM/OFF button**.
2. Whilst holding down the **ALARM/OFF button** press the **Hour** or **Minute button** to set the correct time. Release the buttons when the correct time is reached. The clock uses a 12 hour display with a **PM indicator**. Ensure that the correct 12 hour cycle is selected.

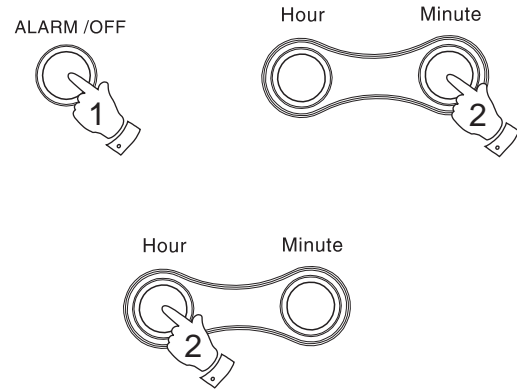

Checking alarm time

1. To check the Alarm time, press the **ALARM/OFF button**. The Alarm time will appear in the display.

ALARM /OFF

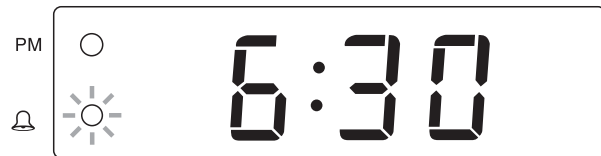

Setting the alarm to wake to buzzer

1. Set the alarm time as previously described. Set the **function switch** to the 'Buzz' position. The **Alarm indicator** will light.

The buzzer alarm will sound every day at the preset time for 1 hour and 59 minutes. To turn off the alarm until the next day press the **ALARM/OFF button**. To turn off the alarm permanently set the **Function switch** to the 'Off' position.

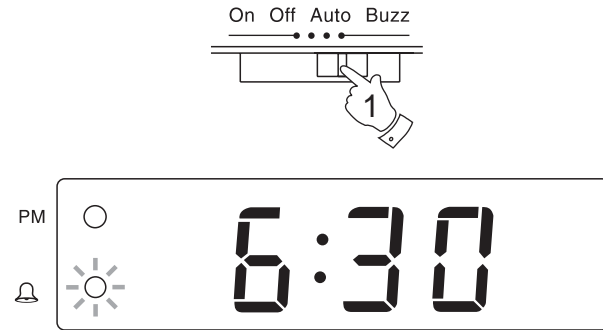

Setting the alarm to wake to radio

1. Set the alarm time as previously described. Set the **function switch** to the 'Auto' position. The **Alarm indicator** will light.

Ensure that the volume is set to the correct level and the desired station is tuned in

The radio alarm will sound every day at the preset time for 1 hour and 59 minutes. To turn off the alarm until the next day press the **ALARM/OFF button**. To turn off the alarm permanently set the **Function switch** to the 'Off' position.

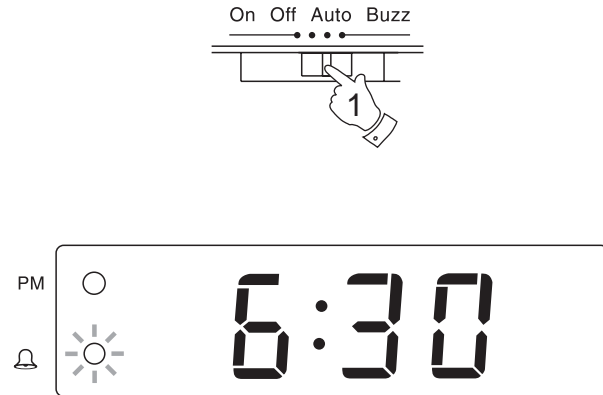

Snooze control

1. The buzzer or radio alarm can be silenced for 9 minutes by pressing the **Snooze** button. This sequence can be repeated several times during the alarm period.



Sleep timer

1. The radio can be set to switch off automatically after a preset time has elapsed.
2. Press and release the **Sleep button**, 59 minutes is displayed. The radio will be on for 59 minutes then turn off automatically.
3. For a shorter sleep time hold down the **Sleep button** and the **Minute button**, the display will count from 59 to 0. Release the buttons when the desired sleep time is reached.
4. The sleep time can be extended to 1 hour and 59 minutes by holding down the **Sleep button** and pressing the **Hour button** once.
5. To set the sleep time for duration between 1 hour 59 minutes and 1 hour, hold down the **Sleep button** and the **Minute button**, the display will count from 1 hour 59 minutes to 1 hour. Release the buttons when the desired sleep time is reached.
6. To end the sleep function prematurely, press the **Snooze button**.

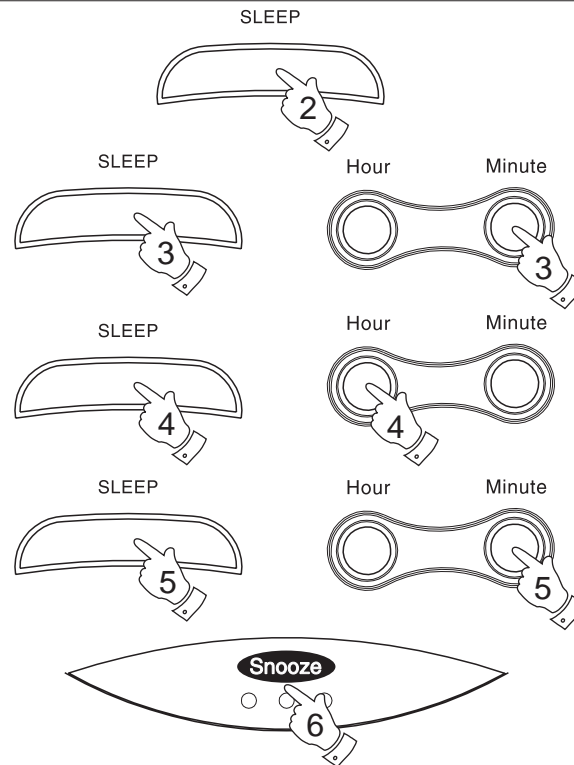

If you need any further advice, please call our Technical Helpline on :-
020 8758 0338 (Mon-Fri)

Headphones

1. A **Headphone Socket** (3.5mm) located on the back of the unit is provided for use with either headphones or an earpiece. Inserting a plug automatically mutes the internal loudspeaker.

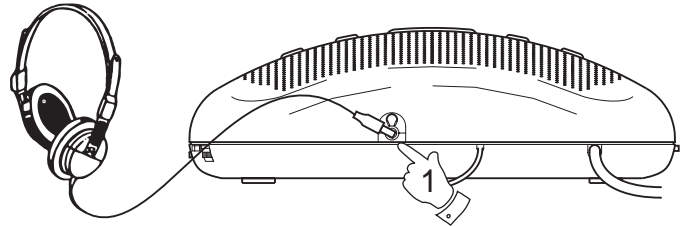

Specifications

Power Requirements

Mains	AC 230 volts, 50Hz  only
Back-up Battery	IEC size 6F22/06PP (6LR61, PP3)

Frequency Coverage

FM	87.5 - 108MHz
MW	525 - 1605kHz
LW	150 - 285kHz

Circuit Features

Loudspeaker	8 ohms	
Output power	0.8 Watts	
Aerial System	FM	Wire Aerial
	MW/LW	Built-in Ferrite Bar aerial

The Company reserves the right to amend the specification without notice.

*If you need any further advice, please call our Technical Helpline on :-
020 8758 0338 (Mon-Fri)*

General

Do not allow this unit to be exposed to moisture (e.g. dripping or splashing) or to temperatures exceeding 70 degrees centigrade. It is recommended that the FM band be used wherever possible as better results in terms of quality and freedom from interference will usually be obtained than on the MW/LW bands.

Mains supply

The CR9961 will operate from a supply of AC 230volts, 50Hz \sim only. For your convenience this product is supplied with a plug which is fitted with a fuse of the appropriate rating. If the plug supplied is not suitable for your socket outlet, it should be removed by unscrewing the plug top, the terminal screws and removing the cable.

The correct style of plug to suit your household together with a correctly rated fuse should be fitted.

IF IN DOUBT - CONSULT A QUALIFIED ELECTRICIAN

IMPORTANT: DO NOT make any connection to the larger terminal which is marked with the letter E or by the safety earth symbol \perp or coloured Green or Green-and-yellow.

The wires in the mains lead are coloured in accordance with the following codes :-

BLUE - NEUTRAL

BROWN - LIVE

As these colours may not correspond with the coloured markings identifying the terminals in your plug, proceed as follows:-

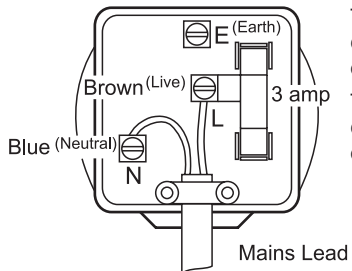

The wire coloured BLUE must be connected to the terminal marked N or coloured BLACK.

The wire coloured BROWN must be connected to the terminal marked L or coloured RED.

Fuse

This apparatus must be protected by a 3A fuse (BS1362) in a 13A plug (BS1363). If another type of plug is used a 5A fuse should be fitted in the plug, adaptor or distribution board.

IF IN DOUBT - CONSULT A QUALIFIED ELECTRICIAN.

Back-up Battery (not necessary for the unit to function)

Slide the battery cover catch in the direction of the arrow. Open the battery cover. Fit a 9 volt IEC size 6F22/06PP (6LR61, PP3) or equivalent battery into the compartment. Observe the correct polarity as shown inside the battery compartment. Replace the battery cover.

The time and alarm settings will be retained during a temporary failure of the AC mains supply. The LED display will not be operational. The display will be extinguished to conserve battery life, but the memory will retain details of the time and alarm time settings.

If your clock radio is not to be used for a prolonged period of time, remove the battery to avoid damage by battery leakage.

The Nameplate is located on the underside of your clock radio.

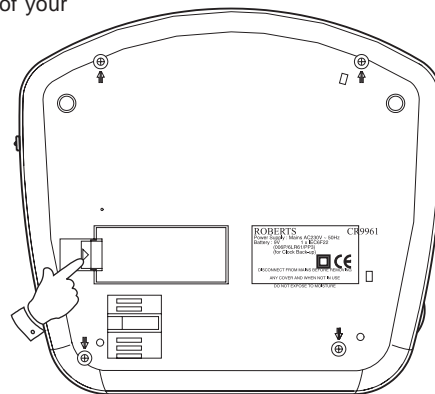

Notes

Notes

Guarantee

This instrument is guaranteed for twelve months from the date of delivery to the original owner against failure due to faulty workmanship or component breakdown, subject to the procedure stated below. Should any component or part fail during this guarantee period it will be repaired or replaced free of charge.

The guarantee does not cover:

1. Damage resulting from incorrect use.
2. Consequential damage.
3. Receivers with removed or defaced serial numbers.

Procedure:

Any claim under this guarantee should be made through the dealer from whom the instrument was purchased. It is likely that your Roberts' dealer will be able to attend to any defect quickly and efficiently, but should it be necessary the dealer will return the instrument to the company's service department for attention. In the event that it is not possible to return the instrument to the Roberts' dealer from whom it was purchased, please contact Roberts Radio Technical Services department at the address shown on the rear of this manual before taking further action.

These statements do not affect the statutory rights of a consumer.

*If you need any further advice, please call our Technical Helpline on :-
020 8758 0338 (Mon-Fri)*

ROBERTS RADIO TECHNICAL SERVICES

97-99 Worton Road
Isleworth Middlesex
TW7 6EG

