

AP400 Audio Conferencing System



Installation & Operation Manual

ClearOne[®]
You're Virtually ThereSM



© 2002 ClearOne Communications, Inc. All rights reserved. No part of this document may be reproduced in any form or by any means without written permission from ClearOne Communications, Inc. Printed in the United States of America. ClearOne Communications, Inc. reserves specific privileges. Information in this document is subject to change without notice.

AP400 Installation and
Operation Manual
ClearOne Part No. 800-150-001
July 2002 (Rev. 5.0)



AP400 Installation and Operation Manual

Table of Contents

CHAPTER 1: Introduction	1
Product Overview	1
Features	2
Professional Services Group	3
Technical Support	3
Sales and Customer Service	3
ClearOne Communications EuMEA GmbH	3
Product registration	3
Product returns	3
Unpacking	4
Controls and Connections	4
Front panel	4
Rear panel	5
G-Link Network	6
G-Link bus	6
CHAPTER 2: Installation	9
Equipment Requirements	9
Power requirements	9
Telephone line requirements	9
Auxiliary equipment	9
Equipment placement	9
Environmental requirements	9
Hardware Setup	10
Connecting the unit	11
Networking Units	12
G-Link connections	12
Device IDs	13
Mixer mode	13
LCD Programming	15
Menu trees	15
System parameters	17



Input parameters	23
Output parameters	26
Routing parameters	26
Meter parameters	29
CHAPTER 3: AP-Ware Software	31
Description	31
Installing AP-Ware	32
To install AP-Ware	32
CHAPTER 4: Operation	33
Front Panel	33
Controlling the volume	33
Muting	33
Telco Interface	34
To make and disconnect a call	34
Other telco options	35
Controllers	35
Custom control through DB-25 port	35
Touch panel control	36
APPENDICES	37
Appendix A: Specifications	37
Appendix B: Warranty and Compliance	38
Appendix C: Connector Pinouts	42
Appendix D: Accessories	43
Appendix E: Serial Port Commands	43
Appendix F: Worksheets	66
Index	69

CHAPTER 1: Introduction

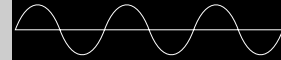

Product Overview

Congratulations on purchasing the Audio Perfect® 400, an advanced eight-by-eight digital matrix mixer with Gentner® Distributed Echo Cancellation®, audio processing, and a single-line telephone hybrid. It uses six user-definable presets to quickly adapt to a variety of teleconferencing and sound reinforcement applications such as distance learning, teletraining, telemedicine, courtrooms, conference rooms, boardrooms, hotels, and houses of worship.

All of the AP400's functions are programmed in AP-Ware™, an all-new configuration software. The result is quicker setup, with fewer hassles and more control.

In its most simple form, the AP400 is a mic mixing matrix. As such, all mic mixing parameters can be customized and any input or combination of inputs can be routed to any output or combination of outputs. This allows great flexibility in accommodating a variety of applications and requirements.

The AP400 features numerous functions which greatly enhance its performance and flexibility. For example, it can gate mics on and off when the sound within a mic's acceptance pattern reaches a certain level.

The AP400 monitors each mic independently, observing ambient levels and making decisions based on each mic's environment. Thus, the input for a mic located in a highly reverberant part of a conference room is gated, mixed, and processed to compensate for the changes in that area and to reduce echo and noise. This improves audio quality and decreases the possibility of feedback.

The AP400 facilitates local and remote PC setup and diagnostics, logic outputs, and automatic gated mic operation. Mic inputs can be individually customized to gate on and off as you want, while automatic gain control keeps the overall sound level consistent.

Adjustments in routing, level, and other functions can be made through presets activated through a rear-panel closure or an RS-232 serial interface.

Network-based interconnectivity allows up to eight AP400/AP800 units to be connected and controlled as a single unit.



Features

- Distributed Echo Cancellation technology; each microphone has its own echo canceller for a total of eight echo cancellers per unit
- Easy-to-use AP-Ware software for quick configuration of all functions
- 100 percent digital signal processing (DSP) ensures crystal-clear audio with the deepest, most reliable hybrid null
- Simultaneous direct connection to several video codecs
- 8 x 8 matrix mixer
- Internal submixing bus for mixing and level control in sound reinforcement systems
- Eight line output channels expandable with additional AP400 units; any of the eight input channels can be mixed to any of the eight outputs on a given unit; all output levels are adjustable and can be instantly muted
- Four-channel automatic microphone mixer with four line inputs (expandable)
- All automatic microphone functions and operating modes operate across expanded units
- Input gain, audio processing, equalization, muting, and automatic mixer
- Expandable using a high-speed digital network bus; a total of eight AP400s can be interconnected
- All G-Linked devices can be accessed, controlled, and programmed via a single RS-232 connection
- Program, operate and perform diagnostics from the front panel, a connected PC (direct or via modem) or other type of serial remote-control device
- Six programmable presets for instant configuration changes
- Lockout front-panel access for security
- Built-in telephone interface with touch-tone dialing, echo cancellation, continual phone line adaptation, receive reduction, and analog phone line compatibility
- 5W speaker amp output



Professional Services Group

If you need any additional information on how to install, set up, or operate your system, please contact us at one of the locations listed below. We welcome and encourage your comments so we can continue to improve our products and serve your needs.

ClearOne Communications ~ 1825 Research Way ~ Salt Lake City, UT 84119

Technical Support

Telephone: 1.800.283.5936 (USA) or 1.801.974.3760
Fax: 1.801.977.0087
E-mail: tech.support@clearone.com
Web site: www.clearone.com

Sales and Customer Service

Telephone: 1.800.945.7730 (USA) or 1.801.975.7200
Fax: 1.800.933.5107 (USA) or 1.801.977.0087
E-mail: sales@clearone.com

ClearOne Communications EuMEA GmbH

Leonhardstr. 16-18, D-90443 Nuremberg, Germany

Telephone: +49 911 955159-0
Fax: +49 911 955159-10
E-mail: global@clearone.com

Product registration

Please register your AP400 online by visiting ClearOne Technical Support at **www.clearone.com**. When your product is properly registered, ClearOne is better able to serve you should you require technical assistance. Registration information is also used to notify you of upgrades and new product information.

Product returns

All product returns require a return authorization (RA) number. Please contact ClearOne Technical Support before attempting to return your AP400 unit.

Unpacking

Ensure that the equipment shown below was received with your shipment.

! ClearOne is not responsible for product damage incurred during shipment. You must make claims directly with the carrier. Inspect your shipment carefully for obvious signs of damage. If the shipment appears to be damaged, retain the original boxes and packing material for inspection by the carrier. Contact your carrier immediately.

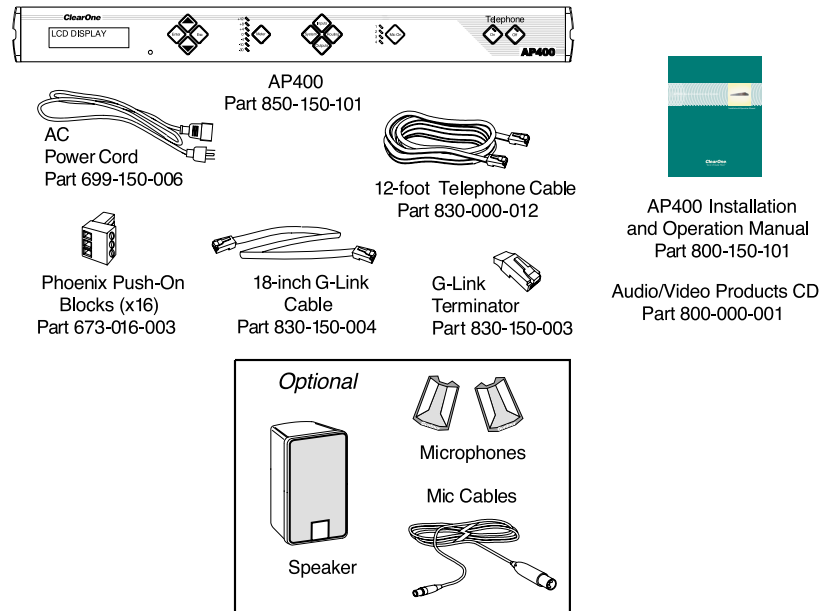

Figure 1.1. Equipment

Controls and Connections

Front panel

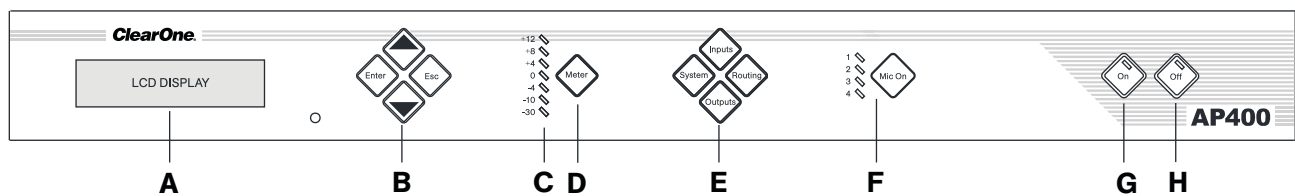

Figure 1.2. Front panel controls

- A. **LCD.** The two-line, 16-character-per-line LCD display is used for AP400 setup and level adjustments in conjunction with the four associated front-panel buttons [B]. Functions that can be accessed via the front-panel LCD include setup, programming, troubleshooting, and numeric audio level and gain readouts.
- B. **Enter/▲▼/ESC.** These buttons are used to navigate the AP400's menu system.

AP-Ware software provides complete configuration capabilities for the AP400. Please refer to the AP-Ware help file for more information.

- C. **LED Meter.** The LED bar meter is displays the audio level of any selected input or output on the AP400, as well as displaying echo return loss (ERL) and echo return loss enhancement (ERLE) for mic channels 1–4.
- D. **Meter.** The Meter button takes you directly to the Meter branch of the AP400's LCD programming tree.
- E. **System, Inputs, Outputs, Routing.** These buttons provide direct access to the corresponding sections in the LCD menu.
- F. **Mic On LED.** These LEDs indicate microphone gate status.
- G. **On.** The On button connects and adapts the AP400 to the telephone line. Pressing and holding the On button for more than two seconds while the AP400 is active readapts the unit.
- H. **Off.** The Off button disconnects the AP400 from the telephone line and mutes all audio to and from the telephone line.



The front panel buttons are also used to enter the front panel passcode. See Lock Panel (page 17) for more details. The front panel passcode can also be created in AP-Ware. Refer to the AP-Ware help file for more information.

Rear panel

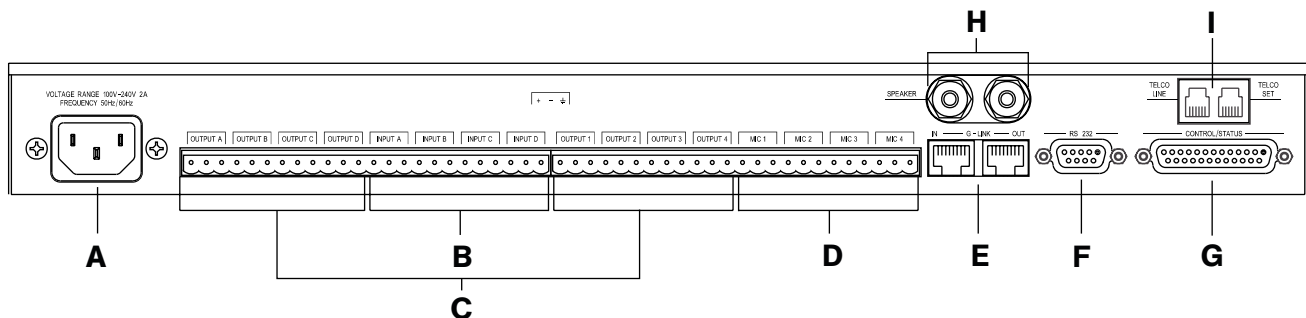

Figure 1.3. AP400 rear panel connectors

- A. **Power.** This power module accommodates power ranging from 100–240VAC, 50/60Hz, 30W. No switching is required.
- B. **Inputs A–D.** These connectors are used with line-level inputs. Inputs can include video codecs, AP10 Telephone Interfaces, VCRs, or CD players, or other audio sources. These inputs can be mixed in any combination with the gated inputs to any of the eight outputs. Nominal input is 0dBu. Mix level can be easily set for each non-gated input.
- C. **Outputs A–D, 1–4.** These connectors allows eight line-level outputs to be connected to the unit. Outputs can include video codecs, AP800s, AP10 Telephone Interfaces, and VCRs. These outputs can be configured to contain any combination of gated and non-gated inputs. The nominal output level is 0dBm.



For electrical specifications, see Specifications, page 37.

- D. **Mics 1-4.** Up to four mic/line-level inputs (selectable) can be connected using the three-terminal Phoenix connector(s).
- E. **G-Link In, Out.** These RJ-45 connectors are part of the AP400's high-speed digital bus network, which passes audio between units.
- F. **RS-232.** This female DB-9 serial port is for connection between the AP400 and a PC, modem, or other custom remote control. For serial communications protocol, see Appendix E, page 43.
- G. **Control/Status.** This female DB-25 connector is used to interface parallel control to the AP400. Most of the pins on this connector can be programmed to perform any function via a contact closure to ground. For instructions on how to program the control and status pins, see page 61 or the AP-Ware help file. These pins go low when active. The six presets can be activated at any time via these connectors. For pinouts, including a description of the default settings, see Appendix C, page 42.
- H. **Speaker.** One five watt, 4-16 Ω speaker can be directly connected to the AP400, eliminating the need for a power amplifier.
- I. **Telco Line.** Connects to your telephone line source.
Telco Set. Connects to your telephone handset.

G-Link Network



Do not attempt to create a system using more than 64 microphones. You can combine up to eight AP800s or AP400s.

Digital technology can provide a distinct advantage in designing and controlling teleconferencing systems. The ability to network with additional AP units (for a maximum of 64 mic inputs) makes the Audio Perfect systems ideal for room combining applications or larger applications which require more microphone inputs.

The G-Link gives you the ability to interconnect the AP400 with other Audio Perfect units (additional AP400s, AP10s, and AP800s). The maximum distance between connected ClearOne units is 20 feet. ClearOne Communications recommends that category five twisted-pair (10Base) cable be used.

G-Link bus

This digital bus is on every Audio Perfect product. It is a mix-minus bus which allows audio to be routed to any destination on the G-Link network. The AP400 has four digital buses: X-bus, Y-bus, Z-bus and G-Link EC Reference bus.



X-bus

This mix-minus bus is defined as the master microphone mix, and it supports NOM (see page 26). All gated microphones are default routed to this bus.

Y-bus

This mix-minus bus is defined as the line input master mix. All line-level audio inputs such as video codecs, AP800s, AP10 Telephone Interfaces, VCRs, etc., are default routed to this bus. Y-bus does not support NOM.

Z-bus

This mix-minus bus is a user-defined auxiliary mix bus. Z-bus does not support NOM.

G-Link EC Reference bus

This bus provides a system-wide echo canceller reference signal. It allows the reference signal to be passed to additional G-Linked mic channels and their associated echo cancellers. Typically, one output on one unit will be passed along the G-Link EC Reference bus.

Control bus

The control bus is an independent channel from the G-Link's audio channel; it uses a different pair of wires on the same cable. This allows control information to pass even if the units are not using the audio link. The AP400 supports the full set of commands through the control bus.



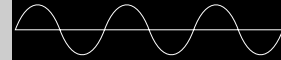

Equipment Requirements

Power requirements

The AP400 will accommodate an AC voltage-input of 100–240VAC, 50/60Hz, 30W.

Telephone line requirements

The AP400's telephone interface operates on a standard analog telephone line and connects with a standard RJ-11C modular jack. If you do not have an RJ-11C jack where you want to install the AP400, contact your telephone company for installation.

Auxiliary equipment

Any auxiliary equipment to be used with the AP800 (i.e., AP400, AP10 Telephone Interface, AP IR Remote Control, desktop kit, microphones, speakers, recording equipment, etc.) should be available at time of installation.

Equipment placement

The AP800 is designed for mounting in a 19" equipment rack. Do not block any of the unit's ventilation holes. With a desktop kit, the unit can be adapted for tabletop placement.

Environmental requirements

The AP800 can be safely operated in a room with varying temperatures between 32° and 110° F (0-43° C).

Hardware Setup

The AP400 is designed for easy installation and setup. All connections are made through rear-panel connectors. This chapter provides instructions on installing the units and making initial connections, creating a G-Link network, assigning device ID numbers, selecting the mixer mode, and using the LCD menu.

The diagram below illustrates the typical connections that are made for a single-unit AP400 system. The default routing settings in AP-Ware allow the AP400 to work out of the box for this type of installation.

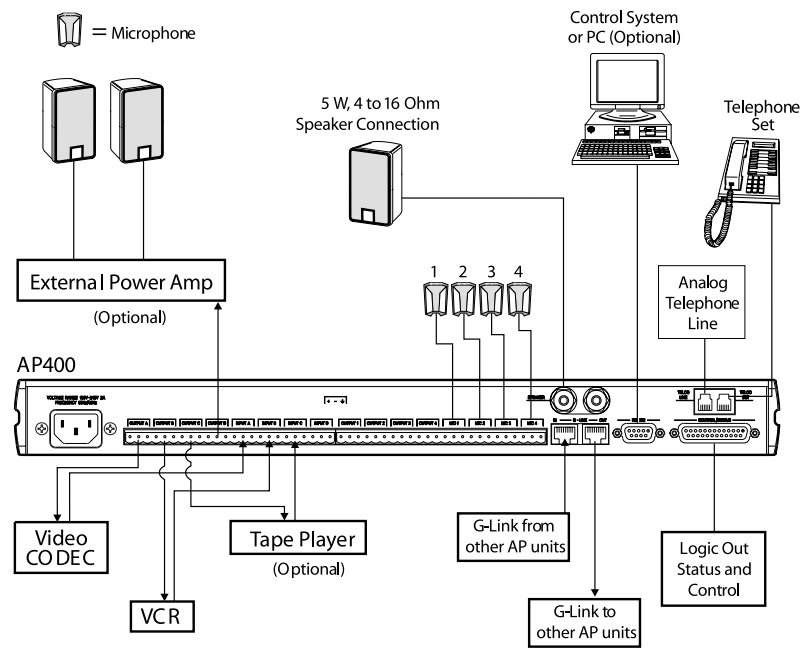

Figure 2.1. AP400 installation diagram



Connecting the unit

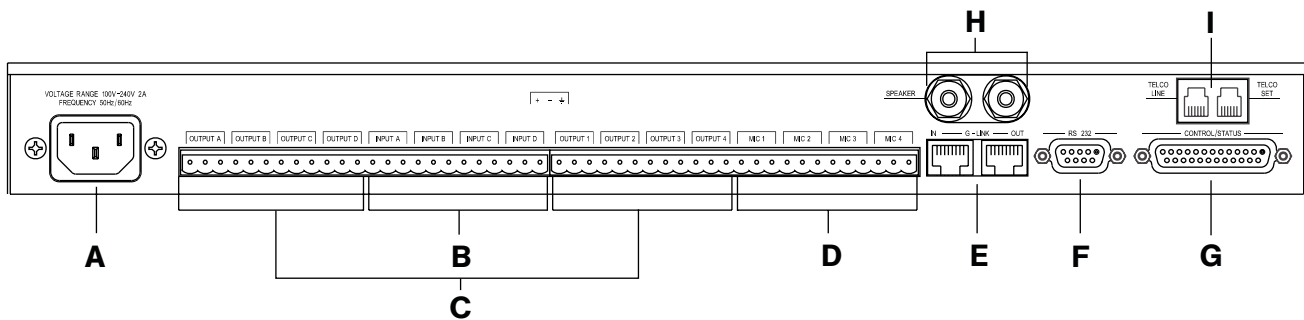

Figure 2.2. Rear panel connections

To connect the AP400

1. Place the unit in a standard 19-inch rack and attach it securely.
2. Connect the telephone line from the wall jack to the RJ-11C Line jack [H].
3. Plug the telephone set into the RJ-11C Set jack [I].
4. If you are using a custom controller for control and status, connect it to the Control/Status port [G].

If you are using an external RS-232 controller or the AP IR remote, connect it to the RS-232 port [F].

5. Wire the inputs and outputs to the AP400 using the provided three-terminal Phoenix push-on connectors. These connectors are designed for easy wiring; simply insert the desired wire into the appropriate connector opening and tighten down the top screw.
 - Mic 1–4 [D] Mic or line level inputs
 - Inputs A–D [B] Line level inputs only
 - Outputs A–D, 1–4 [C] Line level outputs

When connecting, use the screened legend on the back of the unit; overlapping from one channel to another can cause improper operation.

6. Connect the speaker wire to the + (red) and – (black) binding post connectors. A 4–16Ω speaker can be directly connected to the AP400, eliminating the need for an external power amplifier.
7. Plug in the AP400 to complete the installation. The power output [A] will operate at any level between 100–240VAC and 50–60Hz.

If you are installing only one AP400 and are not connecting it to any other AP units, you have completed the hardware installation.

 The three terminals in the Phoenix connector correspond with the rear-panel audio contacts (from left to right): + (positive), – (negative), and ↓ (ground).

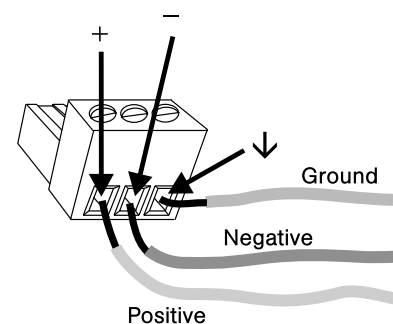

Figure 2.3. Phoenix push-on connector



Networking Units



A G-Link network supports connection of a maximum of any combination of 8 AP400s and AP800s. It also supports up to 16 additional AP10s, for a maximum of 24 telephone lines.

G-Link connections

Using the G-Link connectors, you can connect up to eight AP800/400s and 16 AP10 units, where the total number of microphone inputs does not exceed 64. Make connections between units in daisy-chain fashion using the short RJ-45 jumper (provided). If your units are further apart (maximum distance 20 feet), use category-five twisted-pair cable (10 BaseT).

For a single-unit system, no connection is required in either G-Link In or G-Link Out connectors.

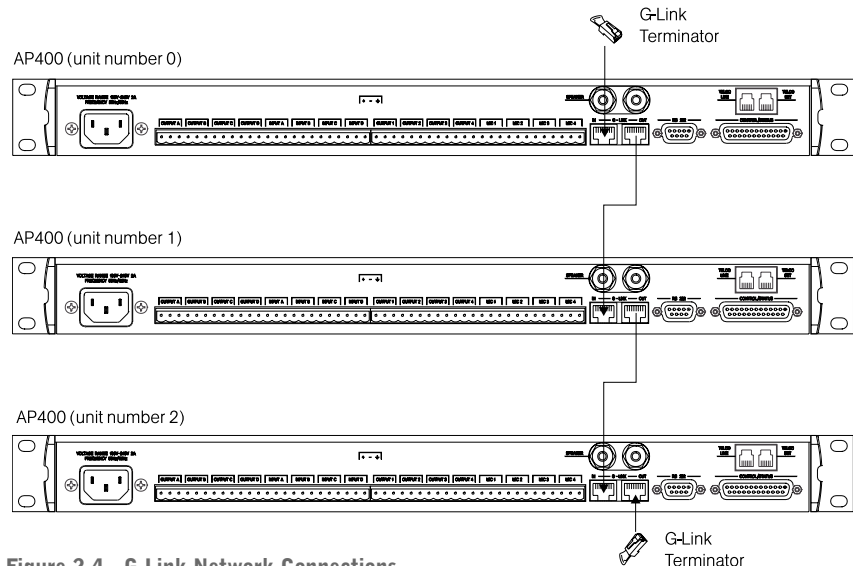

Figure 2.4. G-Link Network Connections

To create a G-Link network

1. Insert a G-Link terminator (provided) in the G-Link In connector of the first unit in the network.
2. Connect the RJ-45 jumper cable (or Cat. 5 twisted-pair cable) to the G-Link Out connector of the first unit and to the G-Link In connector of the second unit. Continue connecting units in the same fashion.
3. Plug the G-Link terminator in the G-Link Out connector on the last unit to complete the network connections.



Device IDs

Once your physical G-Link network is established (and if you have more than one AP unit at a site), you need to specify unique device ID numbers for each AP400 on the network. As shipped from the factory, all AP400 units default as device ID "0". Set device ID numbers for each unit at your site by manipulating the front-panel LCD.

To set the device ID

1. Press the System button, then scroll to Device ID.
2. Press Enter, then scroll through the eight (0–7) options.
3. Press Enter to select the appropriate device ID. Repeat this process for each AP product on the G-Link network.

If the same Device ID is assigned to more than one unit of the same type on the G-Link network, Meter LED "+12" will flash red and Meter LED "0", "-4", "-30", and Mic 4 will flash green on the affected units. To correct the problem, change the device ID on one of the units.

Device types

Device IDs are automatically assigned a device type. AP400s are always device type "3" (AP800 device types are "1", AP10 device types are "2."). The device ID # selected is added to the device type "3" to generate the unique address for that unit. For example, the first AP400 unit in your G-Link network would be identified as "30", "3" being the Device Type, and "0" being the Device ID.

Mixer mode

Once your physical G-Link network is established and unique G-Link device ID numbers for each AP400 on the network are established, the mixer mode must be set. There are three mixer-mode settings: master-single (default), master-linked, and slave.

- Master-single must be used when only one AP400 is used in a system.
- Master-linked denotes the master AP400 unit when more than one AP400 is on the network; only one AP400 can be designated as master-linked when multiple AP400s are used in a system.
- Slave is used for all networked AP400s that are not designated as master-linked or master-single. If two AP400s are part of the same system, set one with the master-linked parameter. Set the other with the slave parameter.

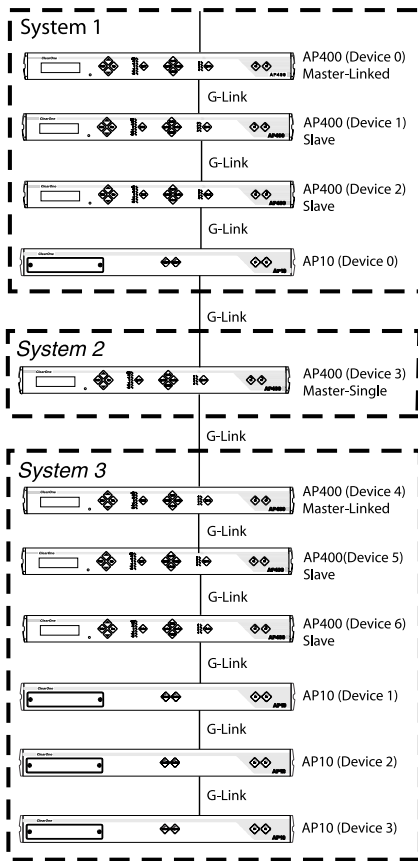

Figure 2.5. Multiple AP systems

A system is defined as one or more AP units that communicate to perform mixing functions. A system can consist of one unit in master-single mode or several units that work together with one master-linked unit and multiple slave units. Systems can be G-Linked together for easy reconfiguration, as shown in Figure 2.5. The physical location on the G-Link network determines which system individual units belong to. In Figure 2.5, for example, AP400 device 4 has been designated as master-linked. The units located below this unit on the G-Link network constitute System 3, while units above it belong to different systems. The entire network could be easily reconfigured into one system by changing the mixer mode on Devices 3 and 4 to slave units which would then refer to the only master-linked unit on the system: AP400 device 0.

To set mixer mode

1. Press the System button. Scroll through the menu until you see Mixer Mode.
2. Press Enter, then scroll through the three options.
3. Press Enter at the appropriate option to select it.
4. Repeat this process for all AP units in the G-Link network.

EC reference

When multiple AP400 units are linked together and will use only one output channel to drive the speaker system, this output must be defined as the acoustic source which will be used by all of the linked AP400s. In other words, the output which the master unit will use as the EC reference must be identified to the slave units via the G-Link. See page 28 for details on echo cancellation setup for multiple units.

Errors

If the units are not connected correctly, you might experience a synchronization error. Meter LED "+12" will flash red and Meter LEDs "0", "-4", and "-30" flash green on affected slave units. The error is the result of one of two problems: incorrect master/slave configuration or a broken G-Link connection.

If it is a master/slave configuration error, LEDs will flash on a unit that is designated as a slave unit but does not have a master unit. To correct the problem, make certain that Mixer Mode for the master unit is set to Master-Linked and not to Master-Single.

If the error is in the G-Link connection, LEDs flash on the units that are not physically connected to master unit. To correct the problem, check for broken connections and reconnect the G-Links.



LCD Programming

For most installations, the default settings in the AP400 do not need to be changed; the system can be used as soon as power is applied. However, if you need to customize any settings, such as telephone connection options or unique routing requirements, you can do so through the front panel user interface or with AP-Ware software.

The front panel includes a 2x16 character LCD, menu buttons, level LED bar meter and gate LED indicators.

When power is applied to the AP400, all LEDs light and the LCD panel reads INITIALIZING. If initialization is completed without any errors, a title screen appears, showing the product name (top line) and the version number (bottom line). The title screen remains on display until you initiate some action that writes information to the LCD panel or the AP400 detects and displays an error. (If an error is displayed, contact our Technical Services Group.)

Menu trees

Five menu trees (menu categories) comprise all of the AP400 options you can control through the front panel: System, Inputs, Outputs, Routing, and Meter. You enter each of the trees, or move from one tree to another, by pressing the corresponding button (right).

The menu trees are structured in levels, such that the first level (top of the tree) branches into multiple subcategories (see Figure 2.7, next page). These branches typically end when an adjustable parameter or viewable value is reached.

Navigating the menu items

Use the ▲ and ▼ buttons to scroll through the menu items at a particular level. When you reach the last menu item, the display scrolls back to the beginning of the list, and vice-versa. If you hold down an ▲/▼ button, the scrolling speed increases.

To descend a menu level (go deeper into the tree), press Enter. To ascend a menu level (go back toward the top of the tree), press Esc.

Switching from one main menu category to another

To switch between main menu categories, press the System, Routing, Outputs, Inputs, or Meter buttons. If the menu tree is left inactive for a period of time (see Timeout, page 22), the LCD reverts to the title screen.

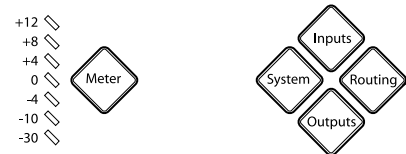

Figure 2.6. Front panel buttons



Pressing ESC at the top of the menu tree has no effect.

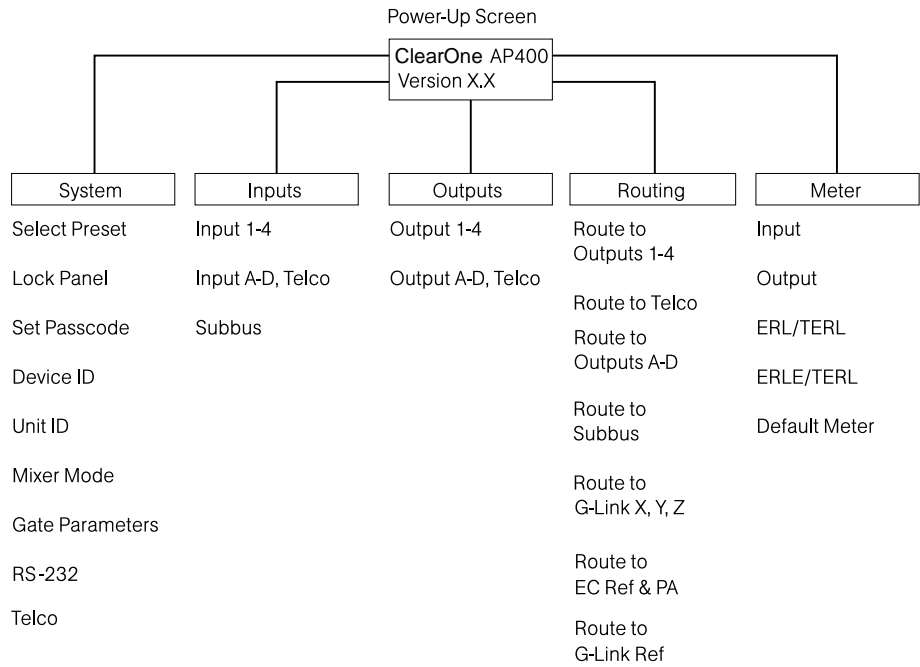

Figure 2.7. LCD menu tree

Adjusting a value

To adjust a parameter, first verify that it is flashing. If the parameter is not flashing, it cannot be adjusted. If the parameter is flashing, adjust the value with the ▲ and ▼ buttons. As the value is adjusted, the parameter is updated immediately. For example, if you adjust input gain, you should be able to hear the difference as it changes. To store the new value, press Enter. To discard the change and revert back to the old value, press Esc. If you press a menu category button while a parameter is being adjusted, it is the same as pressing the Esc key.

In general, while adjusting parameters, numerical values do not wrap around when the end is reached. However, parameters that toggle between two values (or are a list of values) will wrap around. When adjusting a parameter and a ▲/▼ button is held, after 2 seconds the parameter will scroll through its values at a faster rate.



System parameters

The System button enables you to view and adjust nine parameters (see Figure 2.28): Select Preset, Lock Panel, Set Passcode, Device ID, Unit ID, Mixer Mode, Gate Parameters, RS-232, and Telco. For default settings, see the default programming worksheet (page 67). Items printed in boldface are the factory defaults.

Select preset

The Select Preset menu item allows you to select one of the six available preset configurations into the AP400. For example, you can set the AP400 for different room microphone configurations: Preset 1 for a two-mic presentation, Preset 2 for a four-mic conference, Preset 3 for a three-mic priority panel discussion with 20 mics for audience questions.

Scroll through the numbered presets until you see the desired preset. Press Enter. The preset is immediately loaded into AP400 memory for active use.

Lock panel

The front panel can be locked to prevent unauthorized adjustments to the AP400. Menu items can still be viewed when the panel is locked, but settings cannot be altered or entered until the panel is unlocked by entering the appropriate passcode.

To lock the front panel

1. Press the System button.
2. Scroll through the menu items to select Lock Panel, and press Enter.
3. Select On, and press Enter again.

To unlock the front panel

1. Attempt to adjust a parameter. The AP400 prompts you for the passcode.
2. Begin entering the passcode. Once you have correctly entered the fifth character, the front panel unlocks. (The default passcode for all units is ▲▲▼▼Enter.)



If you enter a passcode and unlock the system, you must lock it again after making any changes. Otherwise the panel will remain unlocked and accessible to anyone.

Set passcode

Once you have unlocked the AP400, you can change the passcode. Before the AP400 allows passcode changes, the new passcode must be entered, then re-entered to validate it. The passcode must be five front panel buttons (in any combination or multiple).

A good way to remember the new passcode is to create a word using the first letters of the buttons. For example, using Rooms as the passcode would be the button sequence: Routing, Output, Output, Meter, System.

Device ID

The Device ID menu selection lets you choose from eight G-Link network IDs (0–7). See Device IDs on page 13.

Unit ID

The Unit ID number allows you to view the read-only unit address set at the factory. This unique ID number identifies that particular unit and cannot be changed.

Mixer mode

This setting allows you to set to master or slave mode. See page 13 for details.

Gate parameters

There are nine gate parameters that can be adjusted via the front-panel LCD (Figure 2.8). The parameters in this submenu include: PA adaptive mode, maximum number of mics, first mic priority, last mic mode, gate ratio, off attenuation, hold time, decay rate, and manual ambient.

PA adaptive mode

The AP400 recognizes how much loudspeaker audio is picked up by the microphones. It then uses this level as the new ambient level when audio is present at the power amplifier (see Figure 2.9). This prevents loudspeaker audio from gating on a microphone while still allowing people in the room to gate on microphones as they speak. This mode can be turned on (default) or off by selecting the option and pressing Enter. ClearOne Communications recommends leaving this feature on.

Maximum number of mics

This parameter sets the maximum number of microphones that can be gated on at any one time. This range can be set from one to eight microphones or off. The default setting is four. To set the maximum number of microphones, scroll through the number ranges (one through eight), select the desired number and press Enter.

 When multiple AP400s are used in a system, the gate parameters on all units must be set the same.

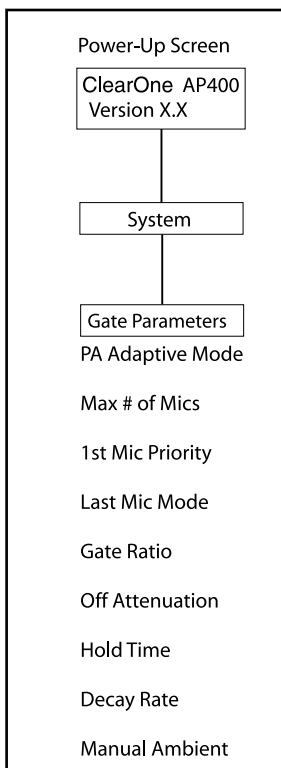

Figure 2.8. Gate parameters LCD submenu

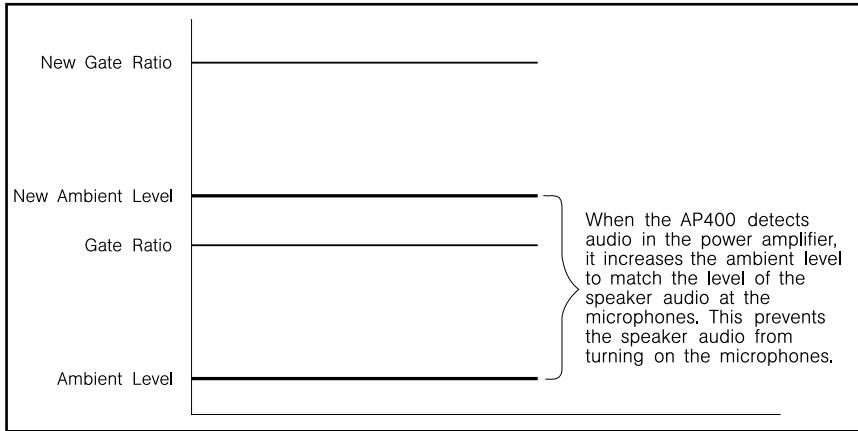

Figure 2.9. PA Adaptive Mode

First mic priority

This feature helps maintain maximum audio intelligibility by allowing only one microphone to gate on when one person is speaking. ClearOne Communications recommends leaving this setting on. When turned off, usually two or more microphones gate on when only one person speaks. However, when this parameter is turned on, one person will usually be able to gate on only one microphone. First Mic Priority does this by determining the audio level received by all microphones when the first microphone is gated on. This audio level is then used as the ambient level for all other microphones. This mode can be turned on (default) or off by selecting the option and pressing Enter.

Last Mic Mode

There are three modes of last mic operation: last on, mic 1 and off. Last on leaves the last-activated microphone full on until another microphone input is gated on. Mic 1 allows the AP400 to revert back to a mic 1 input when all microphones gate off. The default setting for Last Mic Mode is off. To change a last mic mode option, select it, edit the value, and press Enter.

Gate Ratio

The gate ratio specifies how much louder the microphone audio level must be above the ambient level before a microphone gates on. Remember, this value is relative to the ambient level. If adaptive ambient mode is on, the actual on threshold changes as the ambient level changes. The adjustment range is from 0–50dB in 1dB increments. Default setting is 15. If microphones frequently gate on when no one is speaking, increase the gate ratio.

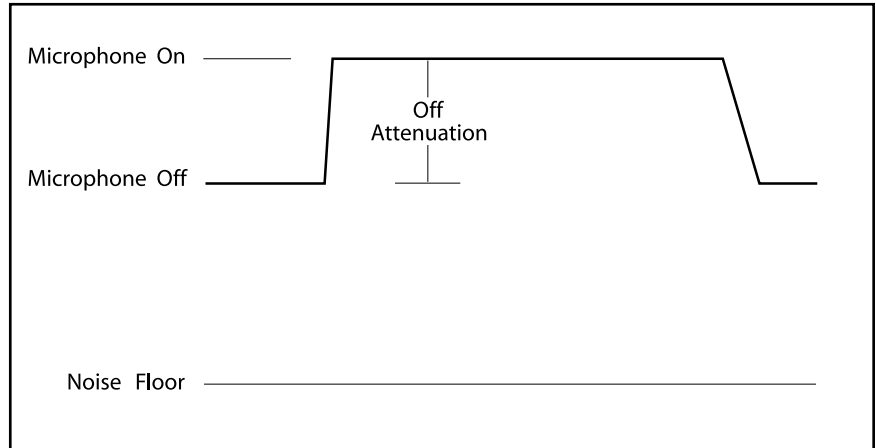

Figure 2.10. Off attenuation

Off Attenuation

This sets the amount of level reduction applied to a microphone when it is off (Figure 2.10, above). Low values increase the amount of echo and reverberation allowed into the system. If the value is set high, you might be able to hear the microphones gate on and gate off as the background noise is reduced. The adjustment range is from 0–50dB in 1dB increments. Default setting is 12dB. As more microphones are added to the system, the off attenuation should be adjusted toward 50 (high).

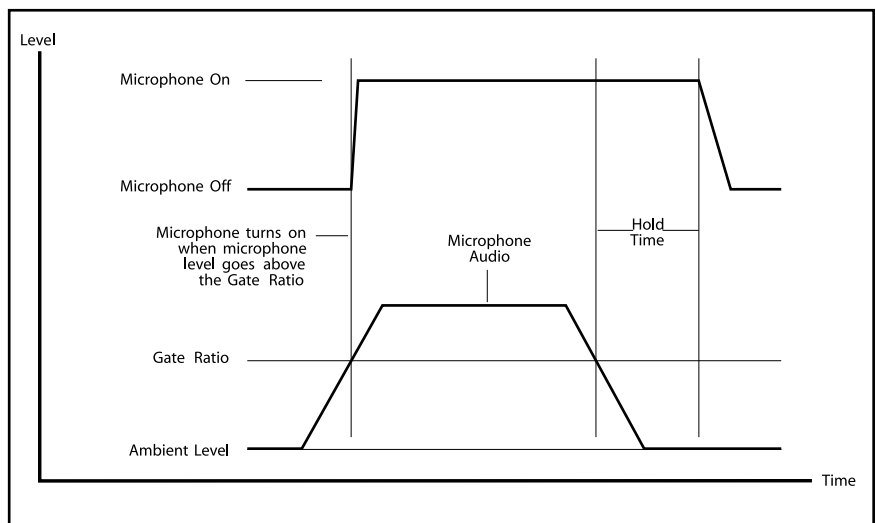

Figure 2.11. Hold time

Hold Time

This feature determines the length of time a microphone remains on after the microphone audio level drops below the gate ratio (see Figure 2.11). Values range from 0.1–8.0 seconds in one-tenth of a second increments. Default setting is 0.3. Setting this value too low might cause the microphones to gate on and off too frequently during brief pauses of speech. However, setting this value too high might cause too many microphones to be on at one time.

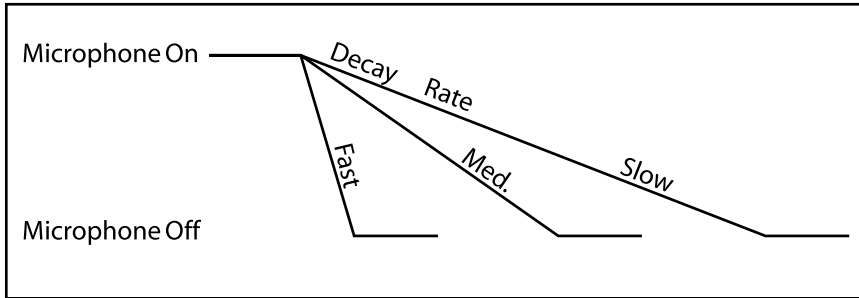

Figure 2.12. Decay rate

Decay Rate

This feature determines how fast a microphone gates off after the hold time expires (see Figure 2.12). Three options are available for this feature: slow (default), medium, and fast.

If your room has very low ambient noise, set the value to fast. This reduces the effects of echo and reverberation. If you hear ambient noise “swoosh down” while the microphones decay, set this value to either medium or slow.

Manual Ambient

This setting is relevant only if the adaptive ambient mode is off on a mic channel (see Adaptive Ambient on page 24). Best results are usually achieved when the adaptive ambient mode is on. However, if you need to set the ambient level to a fixed value, turn off the adaptive ambient mode on the desired microphone channels. A manual ambient setting is a global setting and will affect all mics equally which are set to adaptive ambient off. The ambient level ranges from 0dB to -70dB. The default setting is -30dB.

 Any combination of channels can be set in adaptive ambient or manual ambient modes. Only individual channels cannot be set with both modes active.

To determine ambient level

1. Check your current gate ratio from the Gate Parameters menu. Make a note of the value. Example: “Gate Ratio: 15.”
2. Select Manual Ambient from the Gate Parameters menu. Press Enter to change the dB value.
3. Scroll up or down through the dB values until the mic gates on (gating is indicated when the mic LED lights up). Individual room conditions will determine whether you need to scroll up or down. When the LED flickers, the dB value indicated on the LCD display is the ambient level of the room.
4. Deduct the gate ratio value from the ambient level value you have just determined. For example, if the ambient noise level of the room is identified as -50dB and the gate ratio is 15, the manual ambient setting would be -35dB.

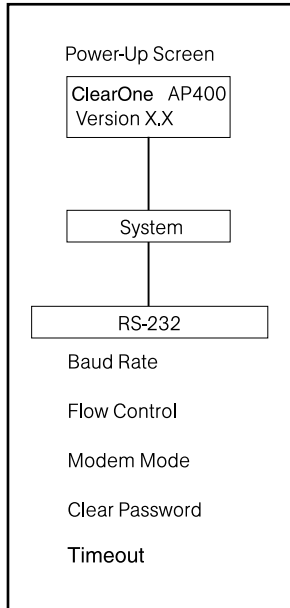

Figure 2.13 . RS-232 parameters LCD submenu

RS-232

Five RS-232 parameters can be adjusted through the menu (see Figure 2.13). These parameters are baud rate, flow control, modem mode, and clear password.

If data is lost during serial access through the RS-232 port, a serial overrun error will occur. This is indicated by flashing microphone LEDs. If the error is caused by incoming data, Meter LED "+12" flashes red; Meter LED "-10" and "Mic 4" flash green. If the error is caused by outgoing data, Meter LED "+12" flashes red; Meter LED "-10" and "Mic 3" flash green. Call our Technical Services Group for help correcting this error.

Baud rate

This parameter sets the AP400's RS-232 port communication rate at either 9,600 (default), 19,200, or 38,400 baud (bps). To set the baud rate, scroll through the three settings to select the desired baud rate, then press Enter.

Flow Control

This parameter allows activation and deactivation of hardware flow control. The two options are On and Off (default). To activate the flow control, scroll to on and press Enter. To deactivate it, scroll to off and press Enter.

Modem mode

This parameter controls whether the AP400 is set to communicate by a modem through its RS-232 port. Upon activating modem mode or when power is turned on while modem mode is active, the AP400 sends an init string to the modem to initialize it. (The init string can only be set through the RS-232 port. See Appendix E, page 56 for information on the the MINIT serial command.) The default setting is off. To activate modem mode, scroll to the on setting and press Enter. To deactivate modem mode again, scroll to off and press Enter.

Clear password

This parameter clears the RS-232 password for modem access. This password is set with the RS-232 command MPASS (see Appendix E, page 57). The Clear Password function is helpful if the password is forgotten and needs to be reset. However, the password cannot be set through the front-panel LCD. It can be set through the RS-232 port. This password is not to be confused with the front panel passcode, which performs a completely different security function.

Timeout

The AP400 has a system mode called Timeout. This parameter can be adjusted through the RS-232 port using the TOUT command (see Appendix E, page 65). Timeout controls the delay time (in minutes) before the LCD panel will automatically switch back to the title screen and default meter. The range is zero to 15 minutes. Default is 10 minutes; zero disables this mode.



Disabling the timeout will allow the AP400 to remain in the same position in the LCD menu until the LCD menu is manipulated again.

Telco

The telephone interface can be set to automatically answer an incoming call (Auto Answer On), or allow the call to be handled manually (Auto Answer Off). The interface can also be set to disconnect upon Loop Drop, Call Progress, Loop Drop + CP (call progress), or to disconnect manually (Auto Disconnect Off).

Input parameters

There are three main submenus under the inputs menu tree: Input 1–4, Input A–D/Telco, and Subbus.

Inputs 1–4

The parameter submenus below this level control how an input channel deals with input audio. All parameters described can be applied to Input 1–4. The 12 mic input parameters (see Figure 2.14) are gain adjust, mic/line input, mic activation, mute, phantom power, AGC, high-pass filter, EQ status, chairman mic, adaptive ambient, echo canceller, and NLP adjust.

Gain Adjust

This adjusts the level for each gated input’s gain (ranging between -20dB and 20dB). In conjunction with the LCD and the LED bar graph, all gated inputs can be simply calibrated for the right level on the mix bus. The default setting is 0dB.

Mic/Line Input

Each input defaults as a microphone level input (55, 25dB gain) but can be switched to a line-level input (0dB).

Mic Activation

Each input defaults to the auto-gate mode, but can be switched to manual mode (manual gate on, manual gate off, gate override on, gate override off). Auto-Gate is where a microphone does not gate on until audio is present at the mic. The AP400 decides to gate the microphone on or off based on parameters set elsewhere in the AP400 (i.e. gate ratio, etc.). Manual On activates a microphone unit until it is manually deactivated. Manual Off deactivates a microphone until it is manually activated. In both cases, this can be done via the Control/Status port. Override On activates a microphone but does not allow it to contribute to mixing parameters, such as set in NOM, maximum number of microphones, etc. Override Off deactivates the microphone.

Mute

This parameter mutes the selected mic channel.

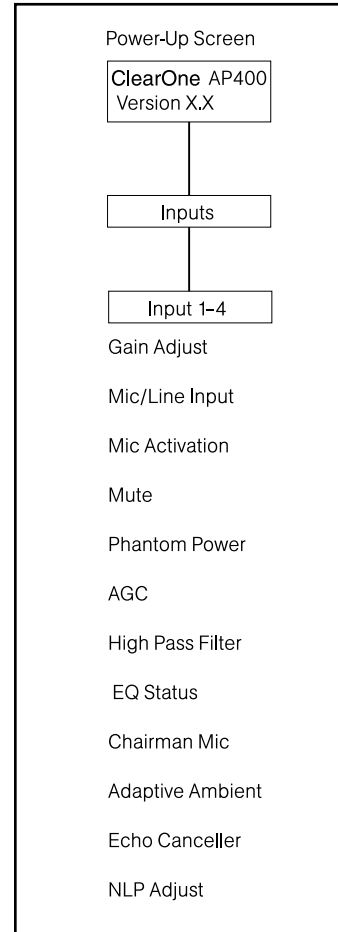

Figure 2.14. Mic Inputs 1–4 parameters

Phantom Power

Each input will default with 24V phantom power enabled, but can be switched off to accommodate input devices not requiring phantom power.

AGC

Each input can use automatic gain control (AGC). This feature keeps softer and louder talkers at a consistent transmit level. This feature is disabled when shipped from the factory. The target gain is 0dB. It adjusts at 2dB per second. The AGC start adjustment is +20dB, but will adjust only +6dB. Adjustments will not be made at .5dB either side of the target (0dB).

High-Pass Filter

A high-pass filter can be selected on each gated input to reduce unwanted noise. The filter has a break frequency at 250Hz, suppresses the signal -3dB at 200Hz, then rolls off at 6dB per octave. This feature is disabled when shipped from the factory.

EQ Status

A graphic equalizer can be enabled (on) or disabled (off) for each input. The equalizer helps match characteristics of dissimilar microphones and adjust general circuit tuning. This EQ circuit provides 12dB of cut or boost centered at frequencies of 250Hz, 1kHz and 4kHz, Q factor of 1.4. This feature is disabled when shipped from the factory. The levels of each band can be adjusted through the RS-232 port with the MEQ command or in AP-Ware.

Chairman Mic

Each input can be selected as the chairman override microphone, allowing the chairman's microphone to gate on, regardless of which other microphones are on. As shipped from the factory, this feature is disabled. This feature can have a single microphone selected or a group of microphones selected.

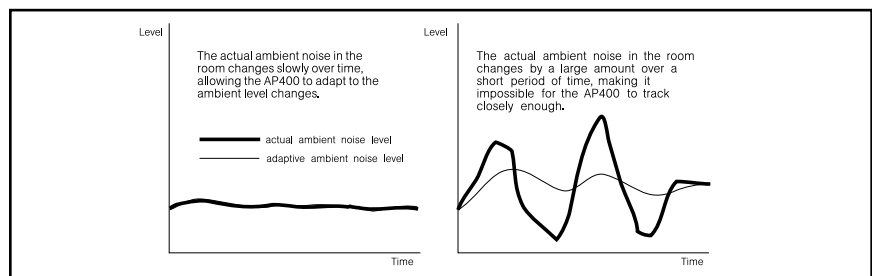

Figure 2.15. Adaptive ambient

Adaptive Ambient

The adaptive ambient mode can be turned on (default) and off. The recommended setting is on. However, if the ambient noise in the room is constantly changing and the AP400 is unable to track properly (see Figure 2.15), turn this mode off and set the ambient level manually (see Manual Ambient, page 21). Fixed values range from 0dB to -70dB, with increments of 1dB.

Echo canceller

Activate or deactivate the echo cancellation feature for each gated input. Factory default is on.

NLP adjust

Non-linear processing (NLP) has four settings: soft (6 dB), medium (12dB), aggressive (18dB), and off. NLP adds additional echo cancelling “horsepower” to the echo canceller in difficult acoustic environments. Care should be taken when using NLP because of the corresponding trade-offs, which can include suppression and half-duplex operation. The factory default is soft.

Inputs A-D, Telco

The parameter submenus below this level control how inputs A, B, C, and D and Telco In deal with input audio. Three input parameters can be applied to the inputs: gain adjust, AGC and mute (see Figure 2.16).

Gain

This adjusts each input’s gain (ranging between -20dB and 20dB). In conjunction with the LCD readout and the LED bar graph, all gated inputs can be simply calibrated for the right level on the mix bus. The default setting is 0dB.

AGC

Each input can use automatic gain control (AGC). This feature keeps softer and louder input audio at a consistent level. This feature is disabled when shipped from the factory.

Mute

This parameter mutes a particular input channel.

Subbus

The subbus parameter allows control of gain (attenuation) of mix audio from the microphones into the speaker audio. The attenuation can be adjusted in dB.

Gain

The subbus gain can be adjusted over a range of 0 to -20dB, in 1 dB increments. The default setting is -6dB.

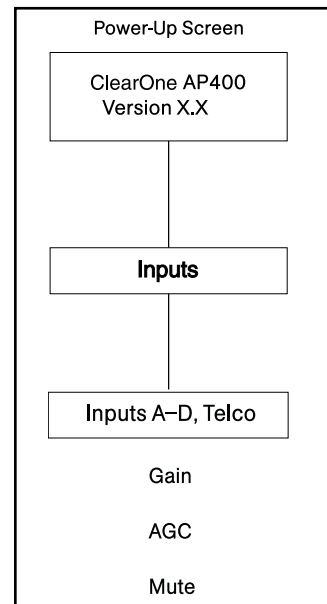

Figure 2.16. Inputs A-D submenu

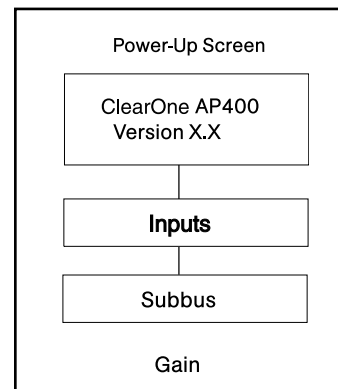

Figure 2.17. Inputs A-D submenu

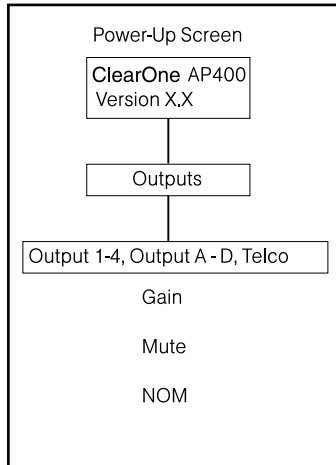

Figure 2.18. Output parameters LCD submenu

Output parameters

There are two main submenus under the outputs menu tree: Output 1–4 and Output A–D/Telco Out. The two main submenus contain the same menus at the next menu depth: gain adjust, mute and NOM (Figure 2.18). Each parameter is applied to the respective outputs (1–4 or A–D/Telco Out).

Output 1-4, Output A-D, Telco

Gain adjust

This adjusts each output's gain (ranging between -20dB and 20dB). In conjunction with the LCD readout and the LED bar meter, all gated outputs can be simply calibrated for the right level on the mix bus. Default is 0dB.

Mute

This parameter mutes a particular output channel.

NOM

Number of open mics (NOM) corrects for increased output level when more than one microphone is gated on. As microphones gate on, the AP400 reduces the level according to the number of active microphones. This mode can be turned on (default for outputs A-C, Telco) or off (default for outputs 1–4, and output D). NOM adjusts at $10\log$ of the number of open microphones, or approximately 3dB every time the mic count doubles.

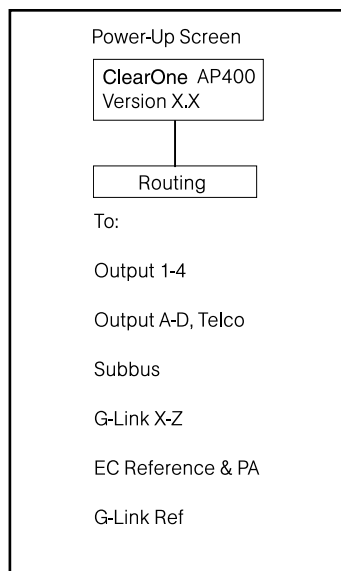

Figure 2.19. Routing parameters LCD submenu

Routing parameters

When programming routing through the front-panel LCD, there are multiple submenus (routing destinations) below the Routing menu (see Figure 2.19): route to output 1–4, route to Telco Out, route to output A–D, route to Subbus, route to G-Link X–Z, route to EC reference and PA, or route to G-Link Ref. Select one of these parameters and press Enter to scroll through the inputs available for routing to that output. When the correct input appears, press Enter to route it to that output.

Routing consists of determining which inputs go to which outputs. When considering routing, refer to the default routing matrix (Figure 2.20). There is also a routing matrix worksheet at the end of this manual (see Appendix F, page 66).

The audio matrix is made of sources and destinations. There are 17 possible input sources and 13 destinations on the AP400 matrix.



Subbus

The AP400 is equipped with one internal sub-mix bus. The subbus is a matrix output which allows signals to be mixed and level controlled. The subbus is then made available as an input to the matrix for further signal routing.

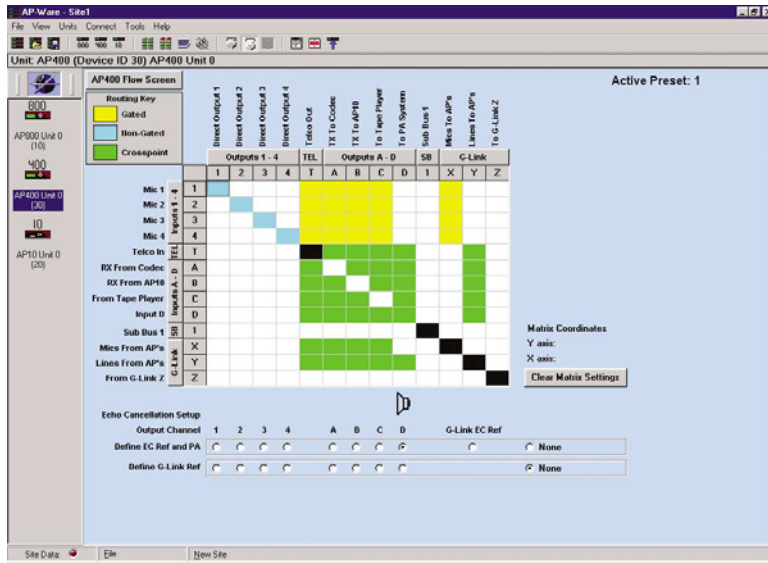

Figure 2.20. Default routing matrix

G-Link X-Z buses

See page 7 for a description of this submenu.

EC reference and PA

The EC reference tells the microphones which output will be used as the sample reference for echo cancellation. EC REF references Output D (typically used for connection to an external amp speaker). A unit will support one common EC reference for all four microphones (as shown in Figure 2.21). Note that the PA output follows the settings for the EC Ref. This is because any audio being sent to a speaker must be used as EC Ref for Echo Cancellation to work properly.

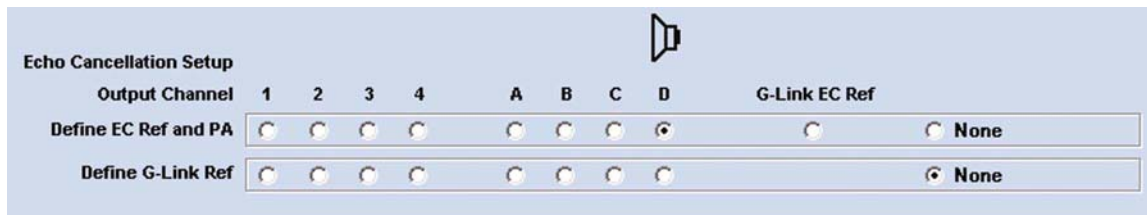

Figure 2.21. Echo cancellation setup default matrix

G-Link reference

This bus provides a system-wide echo canceller reference signal. When multiple AP units are linked together and will be using only one output channel to drive the speaker system, that output must be defined as the sample reference which will be used by all of the linked AP units for echo cancellation. It allows the reference signal to be passed to additional G-Linked mic channels and their associated echo cancellers. For echo cancellation to function properly, the output that the master unit will use as the EC reference must be identified to the slave units through the G-Link (see Figures 2.22 and 2.23 for Routing configuration). The following example illustrates the echo cancellation setup necessary to communicate the EC reference from the master unit to the slave unit:

“Define EC Ref and PA” tells the master unit which output (in this case output D) will be used as the reference for echo cancellation for the master unit. This output (D) must also be defined as the “G-Link EC Ref bus” which slave units will refer to when you are defining their EC references (see Figure 2.22).

Echo Cancellation Setup	Output Channel	1	2	3	4	A	B	C	D	G-Link EC Ref
Define EC Ref and PA		<input type="radio"/>	<input type="radio"/>	<input type="radio"/>	<input type="radio"/>	<input type="radio"/>	<input type="radio"/>	<input type="radio"/>	<input checked="" type="radio"/>	<input type="radio"/> None
Define G-Link Ref		<input type="radio"/>	<input type="radio"/>	<input type="radio"/>	<input type="radio"/>	<input type="radio"/>	<input type="radio"/>	<input type="radio"/>	<input type="radio"/>	<input checked="" type="radio"/> None

Figure 2.22. EC setup for multiple units to one output (master-unit example matrix)

Slave unit

Because the slave unit will not usually be using one of its own outputs as the EC reference, “EC Ref and PA” should be defined as the “G-Link EC Ref” only (as shown in Figure 2.23). The slave unit will then use the master’s defined output (in this case, Output D) as its reference for echo cancellation.

Echo Cancellation Setup	Output Channel	1	2	3	4	A	B	C	D	G-Link EC Ref
Define EC Ref and PA		<input type="radio"/>	<input type="radio"/>	<input type="radio"/>	<input type="radio"/>	<input type="radio"/>	<input type="radio"/>	<input type="radio"/>	<input type="radio"/>	<input checked="" type="radio"/> None
Define G-Link Ref		<input type="radio"/>	<input type="radio"/>	<input type="radio"/>	<input type="radio"/>	<input type="radio"/>	<input type="radio"/>	<input type="radio"/>	<input type="radio"/>	<input checked="" type="radio"/> None

Figure 2.23. EC Setup for multiple units to one output (slave-unit example matrix)

Meter parameters

There are five main submenus under the Meter menu tree (Figure 2.24).

Inputs, Outputs, ERL/TERL, and ERLE/TERLE

The first four submenus are all handled in the same way. Using the LCD, press the Meter button, then scroll through the options (inputs, outputs, ERL/TERL and ERLE/TERLE) to specify which is to be metered by the front-panel LED meter. When the appropriate option is visible, press Enter to begin monitoring its status on the front-panel LED.

Default Meter

The default meter parameter determines what is being displayed on the LED meter when a parameter is not using the LED bar graph, and the AP400 times out (see Timeout, page 22).

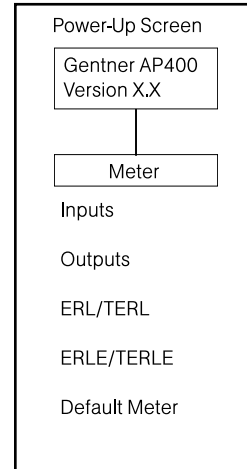

Figure 2.24. Meter parameters

AP400 Parameters Worksheet													
System Wide Parameters							Auto Mix Parameters						
Program Parameter	Selection Range	1	2	3	4	A	B	C	D	Telco	S1	Program Parameter	Selection Range
Preset	1 - 6											PA Adaptive	On, Off
Look Front Panel	On, Off											Maximum No. of Mics	Off, 1-8 (4)
Set. Passcode	Any Five Front Panel Keys											First Mic Priority	On, Off
Device ID No.	0 - 7											Last Mic Mode	Last On, Off, or Mic 1
Unit ID No.	Factory Programmed											Gate Ratio	0 - 50 dB (15)
Mixer Mode	Master-Single/Linked, Slave											Off Attenuation	0 - 50 dB (12)
RS-232 Baud Rate	9.6, 19.2, 38.4kbps											Hold Time	.1 - 8.0 seconds (3)
RS-232 Flow Control	On, Off											Decay Rate	Slow, Medium, Fast
Modem Mode	On, Off											Manual Ambient	0dB to -70dB (-30)
Clear Modem Password	Enter												
Timeout	0 - 15 (10)												
Auto Answer	On, Off												
Auto Disconnect	Off, Loop Drop, Call Prog, LD + CP												
*Telco Adapt Mode	Auto, Burst												
*Hook Duration	50 ms, 500ms												
*Receive Reduction	On, Off												
Input Channel													
Program Parameter	Selection Range	1	2	3	4	A	B	C	D	Telco	S1		
Input Gain Adjust	-20dB to 20dB (0)												
Subbus Attenuation	0dB to -20dB (-6dB)												
Input Type	Mic 55dB, Mic 25dB, Line												
Microphone Activation	Auto, Override On/Off, Manual On/Off												
Mute	On, Off												
Phantom Power	On, Off												
AGC	On, Off												
High-Pass Filter	On, Off												
EQ	On, Off												
*Low Band EQ	-12dB to 12dB (0)												
*Mid Band EQ	-12dB to 12dB (0)												
*High Band EQ	-12dB to 12dB (0)												
Chairman Mic	On, Off												
Adaptive Ambient	On, Off												
Echo Cancellation	On, Off												
NLP	Off, Soft, Medium, Aggressive												
Output Channel													
Program Parameter	Selection Range	1	2	3	4	A	B	C	D	Telco			
Output Gain Adjust	-20dB to 20dB (0)												
Mute	On, Off												
NOM	On (A - C, Telco) or Off (1 - 4, D)												

* Set up only by serial port

Figure 2.25. Default programming worksheet

CHAPTER 3: AP-Ware Software

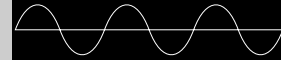

Description

AP-Ware software is an all-new system software for Audio Perfect products. It replaces AP Tools software in ClearOne's software line. AP-Ware provides increased configuration and system monitoring capabilities, and is straightforward to use. All AP400 functions can be configured with AP-Ware.

AP-Ware software requirements

AP-Ware software must operate on computer equipment that meets the following minimum requirements:

Windows 95 OSR2/98/ME/NT	64MB RAM
Windows 2000	128MB RAM
Windows XP	256MB RAM

- PII 200MHz processor or AMD equivalent
- 1024x768 SVGA (16-bit) high color
- 8MB Video card
- IE 4.0
- 20MB hard drive space
- RS-232 COM port
- CD-ROM drive



AP-Ware can be used with systems that were set up with AP Tools. System settings and presets will not be lost when upgrading to AP-Ware.

Installing AP-Ware



To select an alternate destination directory, click **Browse** and use the **Choose Directory** window to find the desired location. Click **OK** to return to the previous window.

To install AP-Ware

1. Boot the PC to the Windows operating system. Ensure that all other programs or applications are closed. Insert the Audio and Video Products CD into the CD-ROM drive.

If the Autorun feature is enabled on the PC, the ClearOne Welcome window opens. Click the **Software** tab and select **AP-Ware**.

If the Autorun window does not open, open the Windows Start menu and choose **Run**. Type "**<drive>:\clearone.exe**" where **<drive>** is the letter of the CD-ROM drive (e.g., **D:\clearone.exe**).

2. At the AP-Ware window, click **Install AP-Ware** near the bottom of the window.
3. The InstallShield Wizard opens, and guides you through the Welcome and License Agreement windows. At the Choose Destination Location window, choose the directory where AP-Ware will be installed. We recommend that you use the default directory.
4. Click **Next** or **Yes** to move to proceed through the windows that follow or **No** or **Cancel** to end the installation process.
5. Follow the onscreen instructions. You must restart your computer once installation is complete.

The AP-Ware Program Folder is now added to your Start menu. You can start AP-Ware through the Start menu or by double-clicking the desktop icon.

For complete information about how to configure AP-Ware, start AP-Ware and press the **F1** key to access the help file system.

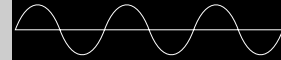

Front Panel

A correctly installed AP400 virtually runs by itself. Typical operations involve changing volume of an output, muting an input or output, or handling calls on the connected telephone handset. For most installations, a custom remote control (optional) will be used.

Controlling the volume

When participating in a conference, you might find it necessary to increase or decrease the volume of a particular output. For instance, when the audio at a distant location is too soft, adjust the output to the speakers so that the level is comfortable.

To adjust the volume

1. Determine which output needs to be adjusted.
2. Press the Outputs button, select the appropriate output and scroll to the Gain selection. Press Enter.
3. Adjust the gain level using the ▲ and ▼ buttons. You should be able to hear the volume level adjust while increasing or decreasing the gain.
4. Press Enter when you reach the desired volume level.

Muting

When participating in a conference, you might find it necessary to mute (or unmute) a particular input or output.

To mute or unmute an input

1. Determine the input you want to mute.
2. Press the Inputs button, and scroll to the desired input channel. Press Enter.
3. Scroll through the input parameters until you see Mute. Press Enter.
4. Use the ▲ and ▼ buttons to select On, then press Enter.

The input is now muted. To unmute the input, follow the same procedure, but select Off to deactivate the mute function.

To mute or unmute an output

1. Press the Outputs button, then scroll to the desired output channel. Press Enter.
2. Scroll through the output parameters until you see Mute. Press Enter.
3. Use the ▲ and ▼ buttons to select On, then press Enter.

The output is now muted. To unmute the output, follow the same procedure, but select Off to deactivate the mute function.

Telco Interface



Detailed instructions on creating site files and using AP-Ware can be found in the AP-Ware help file.

To make and disconnect a call

1. Open AP-Ware and select the AP400 unit.
2. Click the **AP400 Telco** button on the Flow Screen to open the AP400 Telco interface.

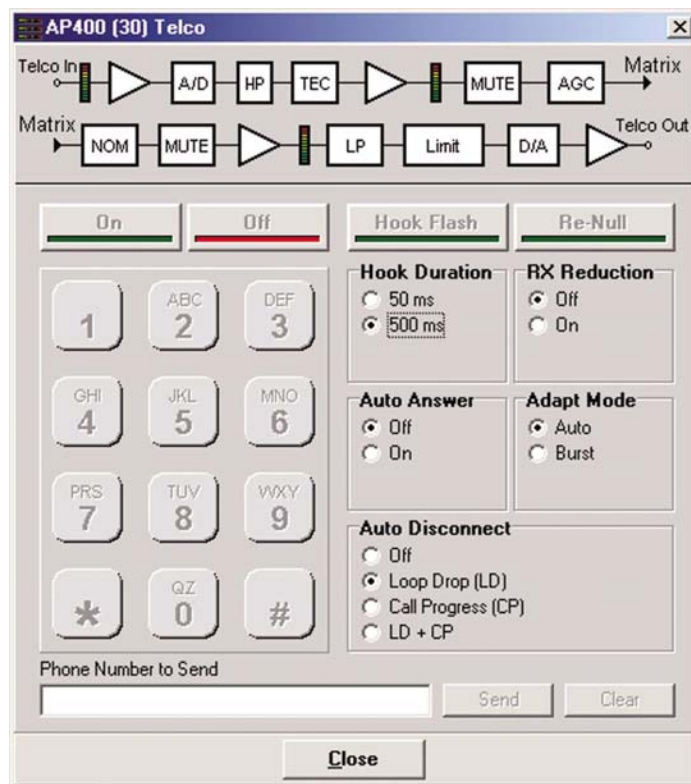

Figure 4.1. Telco interface



3. Activate the telephone interface by clicking **On** or by beginning to dial.
4. Enter the number to be dialed, including any dial-out prefixes.
5. Click **Send**. If you clicked directly on the numbers, the call will be completed as you finish dialing—just like using a standard telephone.
6. When you are finished with the call, click **Disconnect** to end the call.

Other telco options

- **Hook Flash.** This feature sends a momentary interruption in line seizure to the telephone line.
- **Re-Null.** This feature sends a short noise burst down the telephone line and forces the AP400 to adapt to the telephone line.
- **Auto-Answer.** This feature turns auto-answer on and off. If auto-answer is turned on, the AP400 answers the call after the first complete ring. If it is turned off, you will need to manually answer the call.
- **Adapt Mode.** This feature turns allows the AP400 to automatically adapt to line conditions. Burst uses a white-noise burst to adapt the AP400 to line conditions.
- **Auto Disconnect.** This feature selects which condition will trigger an auto disconnect or disable this feature. Loop Drop will disconnect when the line is dropped. Call Progress will disconnect the line upon detection of a valid call-progress signal. LD + CP requires both conditions to be present.

Controllers

Custom control through DB-25 port

A customer-supplied remote control or contact-closure switch can be programmed to perform functions such as: mute on/off, system on, and system off. For pinouts, see Appendix C, page 42.

Touch panel control

The AP products are designed to function with touch panel control systems. The controller is connected to the AP400 RS-232 port. Through the G-Link network, all networked AP products can be accessed and controlled from that single point.

Using a touch panel, you can control the following: AP400 on or off control; transmit and receive audio mute; DTMF tones generation; volume control for receive audio; query of the AP400's binary address; re-nulling the telephone hybrid; metering of input and output, and ERL and ERLE. These commands are also available in the AP-Ware software.

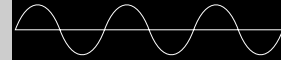

Appendix A: Specifications

Dimensions (LxDxH)

17.25" x 10.25" x 1.75"
43.8 x 26 x 4.5 cm

Weight

7 lb/3.18 kg dry
12 lb/5.4 kg shipping

Operating Temperature

32–100° F/0–38° C

Humidity

15% to 80%, non-condensing

Power Input Range

Auto-adjusting
100–240VAC; 50/60Hz

Power Consumption

30W typical

G-Link In/Out

Proprietary Network
RJ-45 (2), 38.4kbps, 110k Ω impedance
Category five twisted-pair cable 20'
(6 meters) maximum cable length
between two networked Audio Perfect
products

RS-232

DB-9 female
9,600 (default)/19,200/38,400 baud rate
8 bits, 1 stop, no parity
Hardware flow control on (default)/off

Control/Status

DB-25 female A/B
Inputs A/B: active low (pull to ground)
Outputs A/B: Open collector, 40VDC max,
40mA each
+5VDC pins (2) (300mA over-current
protected)

Mic/Line inputs 1-4

Push-on terminal block, balanced, bridging
Impedance: 5k Ω
Nominal Level: adjustable, -55dBu,
25dBu, 0dBu
Maximum Level: -33dBu, -4dBu, +20dBu
Echo Cancellation: 120ms tail time (works
with 12dB of room gain)
Phantom Power: 24V, selectable

Line Inputs A-D

Push-on terminal block, balanced, bridging
Impedance: 20k Ω
Nominal Level: 0dBu
Maximum Level: 19dBu

Outputs 1-8

Push-on terminal block, balanced, bridging
Impedance: 50 Ω
Nominal Level: 0dBm
Maximum Level: 19dBu

Speaker Output

Binding post 5W max into 4 Ω

Telco Line

RJ-11 connector
POTS (plain old telephone service) line or
analog extension from PBX

Telco Set

RJ-11 connector
Connect analog telephone set
A-lead supervision provided

Audio Performance

Conditions: Unless otherwise specified, all
measurements are performed with a 22Hz
to 22kHz BW limit (no weighting).

Frequency Response: 20Hz to 15kHz
 \pm 2dB
Noise (EIN): -125dBu, 15kHz BW, max
gain, $R_s=150\Omega$
THD+N: <0.1%
SNR: 65dB re 0dBu
Dynamic Range: 85dB

Telco Audio Performance

Frequency Response: 250Hz to 3.3kHz
 \pm 2dB (AGC disabled)
SNR: >60dB re -15dBm on/off the
telephone line
THD+N: <0.2%, 250Hz to 3.3kHz
(AGC disabled)
Pre-Emphasis: +4dB @ 2kHz
TEC tail time: 31ms
TEC null: 55dB nominal

Approvals

FCC, ASA, CE

Matrix Mixing Parameters

8x8 matrix

Auto Mixer Parameters

Number of Open Microphones (NOM)
PA Adaptive Mode
First Mic Priority Mode
Last Mic Mode
Maximum # of Mics Mode
Ambient Level
Gate Threshold Adjust
Off Attenuation Adjust
Hold Time
Decay Rate

Microphone Input Configuration

Input Gain Adjust
Mic or Line Level
Phantom Power on/off
Echo Cancellation on/off
Mute on/off
Chairman Override on/off
High Pass Filter
EQ Adjust
AGC on/off
Auto Gate/Manual Gate/Gate Override
Adaptive Ambient on/off

Set-up Software

AP-Ware

Appendix B: Warranty and Compliance

Warranty

ClearOne Communications, Inc. (Manufacturer) warrants that this product is free of defects in both materials and workmanship. Should any part of this equipment be defective, the Manufacturer agrees, at its option, to:

- A. Repair or replace any defective part free of charge (except transportation charges) for a period of one year from the date of the original purchase, provided the owner returns the equipment to the Manufacturer at the address set forth below. No charge will be made for parts or labor during this period;
- B. Furnish replacement for any defective parts in the equipment for a period of one year from the date of original purchase. Replacement parts shall be furnished without charge, except labor and transportation.

This Warranty excludes assembled products not manufactured by the Manufacturer whether or not they are incorporated in a Manufacturer product or sold under a Manufacturer part or model number.

This warranty is void if:

- A. The equipment has been damaged by negligence, accident, act of God, or mishandling, or has not been operated in accordance with the procedures described in the operating and technical instructions; or,
- B. The equipment has been altered or repaired by other than the Manufacturer or an authorized service representative of the Manufacturer; or,
- C. Adaptations or accessories other than those manufactured or provided by the Manufacturer have been made or attached to the equipment which, in the determination of the Manufacturer, shall have affected the performance, safety or reliability of the equipment; or,
- D. The equipment's original serial number has been modified or removed.

NO OTHER WARRANTY, EXPRESS OR IMPLIED, INCLUDING WARRANTY OF MERCHANTABILITY OR FITNESS FOR ANY PARTICULAR USE, APPLIES TO THE EQUIPMENT, nor is any person or company authorized to assume any warranty for the Manufacturer or any other liability in connection with the sale of the Manufacturer's products.

Manufacturer does not assume any responsibility for consequential damages, expenses, or loss of revenue or property, inconvenience, or interruption in operation experienced by the customer due to a malfunction in the purchased equipment. No warranty service performed on any product shall extend the applicable warranty period.

In case of unsatisfactory operation, the purchaser shall promptly notify the Manufacturer at the address set forth below in writing, giving full particulars as to the defects or unsatisfactory operation. Upon receipt of such notice, the Manufacturer will give instructions respecting the shipment of the equipment, or such other matters as it elects to honor this warranty as above provided. This warranty does not cover damage to the equipment during shipping and the Manufacturer assumes no responsibility for such damage. All shipping costs shall be paid by the customer.

This warranty extends only to the original purchaser and is not assignable or transferable.

ClearOne Communications, Inc.
1825 Research Way
Salt Lake City, Utah 84119

FCC Part 15 Compliance

This device complies with part 15 of the FCC rules. Operation is subject to the following two conditions: (1) This device may not cause harmful interference, and (2) this device must accept any interference received, including interference that might cause undesired operation.

FCC Part 68 Compliance

A label containing, among other information, the FCC registration number and Ringer Equivalence Number (REN) for this equipment is prominently posted on the equipment. If requested, this information must be provided to your telephone company.

USOC Jacks: This device uses RJ-11C and RJ-21X terminal jacks.

The REN is used to determine the quantity of devices which may be connected to the telephone line. Excessive RENs on the telephone line might result in the devices not ringing in response to an incoming call. In most, but not all areas, the sum of the RENs should not exceed five (5). To be certain of the number of devices that may be connected to the line, as determined by the total RENs, contact the telephone company to obtain the maximum RENs for the calling area.

If this equipment causes harm to the telephone network, the telephone company will notify you in advance that temporary discontinuance of service might be required. If advance notice is not practical, the telephone company will notify the customer as soon as possible. Also, you will be advised of your right to file a complaint with the FCC if you believe it is necessary. The telephone company may make changes in its facilities, equipment, operations, or procedures that could affect the operation of the equipment. If this happens, the telephone company will provide advance notice for you to make the necessary modifications in order to maintain uninterrupted service.

If you experience problems with this equipment, contact ClearOne Communications, Inc., 1825 Research Way, Salt Lake City, Utah 84119, or by phone at (801) 974-3760 for repair and warranty information. If the trouble is causing harm to the telephone network, the telephone company might request you remove the equipment from the network until the problem is resolved.

Industry Canada Compliance

The Industry of Canada label identifies certified equipment. This certification means that the equipment meets certain telecommunications network protective operational and safety requirements. The Department does not guarantee the equipment will operate to the user's satisfaction.

Before installing this equipment, users should ensure that it is permissible to be connected to the facilities of the local telecommunications company. The equipment must also be installed using an acceptable method of connection. In some cases, the company's inside wiring associated with a single line individual service may be extended by means of a certified connector assembly (telephone extension cord). The customer should be aware that compliance with the above conditions may not prevent degradation of service in some situations.

Repairs to certified equipment should be made by an authorized Canadian maintenance facility designated by ClearOne Communications. Any repairs or alterations made by the user to this equipment, or equipment malfunctions, may give the telecommunications company cause to request the user to disconnect the equipment.

Users should ensure for their own protection that the electrical ground connections of the power utility, telephone lines and internal metallic water pipe system, if present, are connected together. This precaution may be particularly important in rural areas.



European Compliance (for international unit part no. 910-150-101 only)

This equipment has been approved in accordance with Council Decision 98/482/EC for pan-European single terminal connection to the public switched telephone network (PSTN). However, due to differences between the individual PSTNs provided in different countries, the approval does not, of itself, give an unconditionally assurance of successful operation on every PSTN network termination point.

In the event of problems, you should contact your equipment supplier in the first instance.

ClearOne Communications, Inc., of 1825 Research Way, Salt Lake City, Utah 84119, U.S.A. declares that this equipment is designed to be compatible with the following networks: Austria, Belgium, Denmark, Finland, France, Germany, Greece, Iceland, Ireland, Italy, Liechtenstein, Luxembourg, The Netherlands, Norway, Portugal, Spain, Sweden, Switzerland, and United Kingdom.

This equipment complies with the requirements of the EU guidelines:

CE	89/336/EEC	"Electromagnetic Compatibility"
	73/23/EEC	"Electrical operating material for use within specific voltage limits"
	1999/5/EC	"Radio Equipment and Telecommunications Equipment"

Conformity of the equipment with the above guidelines is attested by the CE mark.

Safety Information

CAUTION: Users should contact the appropriate electrical inspection authority, or electrician, as appropriate.

Appendix C: Connector Pinouts

RS-232 COM DCE port pinout

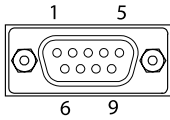

Figure C.1. RS-232 connector

Pin Number	Control	Pin Number	Control
1	DCD	6	DSR
2	TXD	7	CTS
3	RXD	8	RTS
4	DTR	9	No connection
5	Ground		

Control/Status port pinout

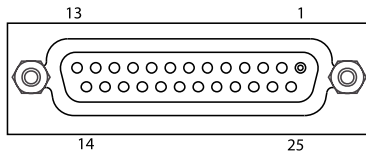

Figure C.2. DB-25 connector

Pin #	Definable*	Status	Moment./Latch.	Default Description
1	Yes	C	M	Lock front panel toggle
2	Yes	S		Status of front panel lock
3	Yes	C	M	Mute all mics toggle
4	Yes	S		Status of mute all mics
5	Yes	C	M	Telephone On/Off toggle
6	Yes	S		Telephone status
7	Yes	C	M	Auto answer toggle
8	Yes	S		Status of auto answer
9	Yes	C	M	Mute Output A toggle
10	Yes	S		Status of Output A mute
11	Yes	C	M	Mute Input A toggle
12	Yes	S		Status of Input A mute
13	Yes	C	M	Volume Up PA (1dB)
14	Yes	S		Not Active
15	Yes	C	M	Volume Down PA (1dB)
16	Yes	S		Not Active
17	No	S		Mic #1 Gate Status
18	No	S		Mic #2 Gate Status
19	No	S		Mic #3 Gate Status
20	No	S		Mic #4 Gate Status
21	No	S		Ring indication
22	No connection			
23	No	*		+5VDC
24	No	*		+5VDC
25	No	*		Ground

Status outputs: DB-25 female; open collector, 40V max, 300mA each
 (2) +5VDC, 300mA each 40V

Control inputs: Input activation selectable; momentary or latching ground

Appendix D: Accessories

Accessory	ClearOne Part Number
AP800	910-150-001
AP10 Telephone Interface	910-150-201
Tabletop Omni Microphone	910-103-160 (with cable)
Tabletop Uni Microphone	910-103-161 (with cable)
Tabletop Omni Microphone	910-103-162 (black button)/ 910-103-163 (white button)
Tabletop Uni Microphone	910-103-164 (black button)/ 910-103-165 (white button)
Delta Microphone	910-103-340
Desktop Kit	860-150-002
Wall Mount Speaker	910-103-010

Appendix E: Serial Commands

The AP products accept serial commands through the AP400 serial port. The commands are then channeled along the G-Link network to all interconnected AP products. The commands provide the same control as the LCD menu structure, plus some additional controls. The following commands pertain only to the AP400.

RS-232 serial port protocol is 9,600 (default), 19,200, or 38,400 baud, 8 bits, 1 stop bit, no parity.

The AP400 accepts the commands outlined on page 45. The structure of serial commands is as follows:

Device ID, command, then any additional options in the order that they appear in the command descriptions on the following pages.

Commands can be either uppercase or lower case. Return values are always in uppercase. For a command to be recognized by the serial port, the command must be terminated by a carriage return.

For example, a command to disable automatic gain control (AGC) for Mic 2 on AP400 device "0" would have the command line: #30 AGC 2 0. In this command line, 3=AP400, 0=unit 0, AGC=command, 2=mic channel, 0=off state). If a command calls for a "null" value, leave a blank in the command line (for example, "#30 AGC 2" would return the current AGC state of Mic 2 on device 30).

Command Syntax

All command lines in this manual are set off by the symbol "0". The serial command line that follows the "0" uses the following typographic conventions:

<X>	Parameters enclosed in "< >" indicate a mandatory parameter
[X]	Parameters enclosed in "[]" indicate an optional parameter
1-8	Parameters separated by a "-" indicate a range between the values
4,7,9	Parameters separated by a "," indicate a list of available values
MREF	Words in ALL CAPS bold indicate command text
DEVICE	Device type and number on G-Link network. (Valid combinations depend on connected devices. For an AP400, device type is 3, and device ID number will always be 0–7.) If omitted, the product that first receives the command processes it.
*	Can be used to set a parameter on all microphone channels, but it can't be used to query all mic channels. Note: Using the all-mic toggle might not produce the desired result, depending on the state they are in. For example, if one mic is muted and all other mics are not, an all-mic toggle would mute all others, but unmute that particular mic.

Error Codes

The following lists possible error messages and their explanations:

Error 1	The address is not valid/out of range or an invalid character.
Error 2	Could not extract a command from the string received.
Error 3	Serial overrun.
Error 4	Reserved.
Error 5	Invalid parameter.
Error 6	Unrecognized command.

The command string will then be explained (where necessary), followed by the returned values and (where necessary) an example.

AP400 Serial Commands

Command	Function	Command	Function
AA	Selects/rprts Auto Answer for Telco port	MDMODE	Enables/disables modem mode
AAMB	Enables/disables adaptive ambient*	MEQ	Sets/reports three-band equalization*
AD	Selcts/rprts Auto Disconn. for Telco port	MHP	Enables/disables high-pass filter*
AGC	Enables/disables AGC*	MINIT	Sets/reports modem initialization string
AMBLVL	Sets/reports ambient level	MLINE	Sets/reports mic/line level*
BAUD	Sets/reports RS-232 port baud rate	MMAX	Sets/reports maximum number/mics
BYE	RS-232 password protection	MPASS	Programs modem password string
CHAIRO	Enable/disable chairman override*	MREF	Sets/reports echo canceller reference*
DECAY	Sets/reports decay rate	MTRX	Programs/reports matrix configuration*
DFLTM	Sets/reports default meter	MUTE	Sets/reports mute status*
DIAL	Sends dial string to Telco port	NLP	Sets/reports nonlinear processing*
EC	Enables/disables echo canceller*	NOM	Enables/disables NOM attenuation*
ERL	Returns ERL for a mic channel*	NULL	Sends Null command to Telco port
ERLE	Returns ERLE for a mic channel*	OFFA	Sets/reports off attenuation
EQ	Enables/disables equalization*	PAA	Enables/disables PA adaptive mode
FLOW	Enables/disables flow-control	PCMD	Programs/reports
FMP	Enables/disables first mic priority	PEVNT	Programs/reports GPIO status pin
FPP	Sets/reports front-panel passcode	PP	Enables/disables phantom power*
GAIN	Sets/reports gain setting*	PRESET	Sets/reports active preset
GATE	Reports mic gating status	REFSEL	Sets/reports output for EC reference
GMODE	Sets/reports gating mode*	RING	(Ring indication only)
GRATIO	Sets/reports gate ratio	RXRD	Selects/reports Receive to Telco port
HOLD	Sets/reports hold time	TAMODE	Selects/reports Telco Adapt mode
HOOK	Sends Hook/Flash command	TE	Selects/reports Telco Off Hook status
HOOKD	Selects/reports Hook duration time	TERL	Returns echo return loss for Telco channel
LFP	Enables/disables front-panel lock	TERLE	Returns echo return loss enhance. for Telco channel
LMO	Sets/reports last-mic-on mode	TOUT	Sets/reports inactivity timeout
LVL	Reports level*	UID	Returns unit identification number
MASTER	Sets/reports master/slave settings	VER	Returns current version of software

* Applied to a specific channel

Figure E.1. AP400 Serial Commands

Serial Command Parameters and Explanations

For serial port command protocol and syntax, see page 43.

AA

This command activates and deactivates the auto answer feature.

[DEVICE] **AA** <X>

Explanation

<X>

X=0	Parameter disables auto-answer
X=1	Parameter enables auto-answer
X=2	Parameter to toggle the state from one state to the other (regardless of current state)
X=Null	Parameter to report back the current state

Return Values

The command will return the updated condition (On=1, Off=0) of the auto answer in the same format as the command.

AAMB

This command changes or reports back the state of the adaptive ambient for a microphone.

[DEVICE] **AAMB** <CH> <X>

Explanation

<CH>

CH= 1-4 Parameter to apply to the specified microphone channel

CH= * Parameter to apply command to all microphone channels

<X>

X=0 Parameter to set the state to OFF

X=1 Parameter to set the state to ON

X=Null Parameter to return the current state

Return Values

The command will return the updated condition (On=1, Off=0) of the adaptive ambient in the same format as the command.

AD

This command changes the state of the auto disconnect function.

[DEVICE] **AD** <X>

Explanation

<X>

- X=0 Parameter to set Auto Disconnect to OFF
- X=1 Parameter to set Auto Disconnect to LOOP
- X=2 Parameter to set Auto Disconnect to Call Progress (CP)
- X=3 Parameter to set Auto Disconnect to LOOP+CP
- X=NULL Parameter to report back the current state

Return Values

The command will return the updated connection state of the unit in the same format as the command. If the sent command changes the state of the unit, the updated state is returned.

If:	Command returns:
current disconnect state is OFF	[DEVICE] AD 0
current disconnect state is LOOP	[DEVICE] AD 1
current disconnect state is CP	[DEVICE] AD 2
current discon. state is LOOP+CP	[DEVICE] AD 3

AGC

This command changes or reports back the state of the AGC for a microphone or line input.

[DEVICE] **AGC** <CH> <X>

Explanation

<CH>

- CH= 1-4 Parameter to apply to the specified microphone channel
- CH= A-D Parameter to apply to the specified line input
- CH= * Parameter to apply command to all microphone channels

<X>

- X=0 Parameter to set the state to OFF
- X=1 Parameter to set the state to ON
- X=2 Parameter to toggle the state from one state to the other (regardless of current state)
- X=NULL Parameter to return the current state

Return Values

The command will return the updated condition (On=1, Off=0) of the AGC in the same format as the command.

AMBLVL

This command changes or reports back the setting of the fixed ambient level for each AP400. This value is only used if adaptive ambient is not enabled.

[DEVICE] **AMBLVL** <X>

Explanation

<X>

- X=0 to -70 Parameter to set the ambient level (in dB)
- X=Null Parameter to return the ambient level

Return Values

The command will return the updated ambient level for the selected AP400 in the same format as the command.

BAUD

This command selects or returns the baud rate for the RS-232 port on the AP400.

[DEVICE] **BAUD** <X>

Explanation

<X>

- X=1 Selects 9,600 baud (bps) rate
- X=2 Selects 19,200 baud (bps) rate
- X=3 Selects 38,400 baud (bps) rate
- X=Null Parameter to return the baud (bps) rate

Return Values

The command will return the updated condition (1=9,600 baud, 2=19,200 baud, 3=38,400 baud) of the RS-232 baud rate in the same format as the command.

BYE

This command immediately enables password protection when modem mode is active.

[DEVICE] **BYE**

Note: This command is applicable only to the unit that is connected through the RS-232 port.

CHAIRO

This command changes or reports back the state of the chairman override for a microphone channel

[DEVICE] **CHAIRO** <CH> <X>

Explanation

<CH>

- CH= 1-4 Parameter to apply to the specified microphone channel
- CH= * Parameter to apply command to all microphone channels

<X>

- X=0 Parameter to set the state to OFF
- X=1 Parameter to set the state to ON
- X=2 Parameter to toggle the state from one state to the other (regardless of current state)
- X=Null Parameter to return the current state

Return Values

The command will return the updated condition (On=1, Off=0) of the chairman override in the same format as the command.

DECAY

This command changes or reports back the setting of the decay rate for a given AP400.

[DEVICE] **DECAY** <X>

Explanation

<X>

- X=1 Parameter to set the decay rate to slow
- X=2 Parameter to set the decay rate to medium
- X=3 Parameter to set the decay rate to fast
- X=NULL Parameter to return the current decay rate

Return Values

The command will return the updated decay rate for the selected AP400 in the same format as the command.

DFLTM

This command changes and reports back the status of the default meter.

[DEVICE] **DFLTM** <CH> <W>

Explanation

<CH>

- CH= 1-4 Parameter to apply to the specified channel
- CH= A-D,T Parameter to apply to the specified channel
- CH= Null Parameter to return the current state of the default meter

<W>

- W= I Parameter to specify an input channel
- W= 0 Parameter to specify an output channel

Return Values

The command will return the current default meter in the same format as the command.

DIAL

This command generates DTMF tones. The capability remains active after the call is place so tones can be issued for use with voice mail and pagers.

[DEVICE] **DIAL** <STRING>

Explanation

<STRING> is any valid combination of touch tone characters. A comma indicates a two-second pause. STRING has a maximum length of 15 characters. Valid characters are 0 through 9, A through D, #, *, and "",/.

Return Values

DIAL returns the dialed string of numbers. For example, the following command dials the number 801-975-7200. A "9" and a pause are generated to get an outside line on a PBX:

The number to be dialed on device #20:

#20 DIAL 9,8019757200

The following is returned out the serial port:

#20 DIAL 9,8019757200

EC

This command changes or reports back the state of the echo canceller for a microphone.

[DEVICE] **EC** <CH> <X>

Explanation

<CH>

CH= 1-4 Parameter to apply to the specified microphone channel

CH= * Parameter to apply command to all microphone channels

<X>

X=0 Parameter to set the state to OFF

X=1 Parameter to set the state to ON

X=NULL Parameter to return the current state

Return Values

The command will return the updated condition (On=1, Off=0) of the echo canceller in the same format as the command.

ERL

This command reports back the echo return loss (ERL) for a microphone channel in dB.

[DEVICE] **ERL** <CH>

Explanation

<CH>

CH= 1-4 Parameter to apply to the specified microphone channel

Return Values

The command will return the ERL of the microphone channel in the same format as the command (#10 ERL 1 20).

ERLE

This command reports back the echo return loss enhancement (ERLE) for a microphone channel in dB.

[DEVICE] **ERLE** <CH>

Explanation

<CH>

CH= 1-4 Parameter to apply to the specified microphone channel

Return Values

The command will return the ERLE of the microphone channel in the same format as the command (#10 ERLE 1 20).

EQ

This command changes or reports back the state of the equalizer for a microphone.

[DEVICE] **EQ** <CH> <X>

Explanation

<CH>

CH= 1-4 Parameter to apply to the specified microphone channel

CH= * Parameter to apply command to all microphone channels

<X>

X=0 Parameter to set the state to OFF

X=1 Parameter to set the state to ON

X=2 Parameter to toggle the state from one state to the other (regardless of current state)

X=NULL Parameter to return the current state

Return Values

The command will return the updated condition (On=1, Off=0) of the equalizer in the same format as the command.



FLOW

This command selects or reports whether hardware flow control is enable or disabled for the AP400. Hardware flow control is implemented using RTS and CTS.

[DEVICE] **FLOW** <X>

Explanation

<X>

- X=0 Sets flow control to OFF
- X=1 Sets flow control to ON
- X=NULL Parameter to return the current mode

Return Values

The command will return the updated condition (On=1, Off=0) of the AP400 in the same format as the command.

FMP

This command selects or returns the current status of the first microphone priority mode for the AP400.

[DEVICE] **FMP** <X>

Explanation

<X>

- X=0 Parameter to select first microphone priority mode to OFF
- X=1 Parameter to select first microphone priority mode to ON
- X=NULL Parameter to return the current mode

Return Values

The command will return the updated condition (On=1, Off=0) of first mic priority mode in the same format as the command.

FPP

This command sets and reports the current passcode setting for the AP400.

[DEVICE] **FPP** <XXXXX>

Explanation

<XXXXX>

- X=1 ▲ button
- X=2 Enter button
- X=3 Esc button
- X=4 ▼ button
- X=5 Meter button
- X=6 Input button
- X=7 System button
- X=8 Output button
- X=9 Routing button
- X=NULL Parameter to return current passcode

Return Values

The command returns the current or updated condition of the front panel passcode.

GAIN

This command changes or reports back the input gain for a channel. The command supports all inputs, outputs, and subbus.

[DEVICE] **GAIN** <CH> <W> <X> [<Y>]

Explanation

<CH>

- CH= 1-4 Parameter to apply to select the microphone channel
- CH= A-D,T Parameter to apply to select the line channel
- CH= 1 Parameter to apply to select the subbus channel
- CH= * Parameter to apply command to all microphone channels

<W>

- W=S Parameter to set subbus
- W=I Parameter to set input
- W= 0 Parameter to set output

<X>

- X= -20 – 20 Parameter to set the level
- X= Null Parameter to return the current level

<Y>

- Y=R Parameter to indicate relative
- Y=A Parameter to set the level absolute
- Y= Null Parameter will default to R (relative)

Return Values

The command will return the updated level of the channel in the same format as the command. The level returned is always absolute.

Examples

The following command lowers the gain 3dB on microphone input channel 2.

This command applies only to the unit to which the serial cable is connected (the device is not specified): GAIN 2 I -3

The following is returned out the serial port, indicating an updated gain value. GAIN 2 I -12

GATE

This command reports back the microphone gating status of an AP400. This command is read only.

[DEVICE] **GATE**

Return Values

The command will return the current status of microphone gating for a given unit with a hex value.

Example

The following command requests the gate status from device 34. (When this command was issued, mics 1 and 4 were gated on.)
#34 GATE

The following is returned out the serial port, indicating an updated gate value.

#34 GATE 9

Microphone gating key

Mic #	4 3 2 1	Hex value
	0 0 0 0	0
	0 0 0 1	1
	0 0 1 0	2
	0 0 1 1	3
	0 1 0 0	4
	0 1 0 1	5
	through	
	1 1 1 1	F



GMODE

This command changes or reports back the gating mode for a microphone.

[DEVICE] **GMODE** <CH> <X>

Explanation

<CH>

- CH= 1-4 Parameter to apply to the specified microphone channel
- CH= * Parameter to apply command to all microphone channels

<X>

- X=1 Parameter to set the state to AUTO
- X=2 Parameter to set the state to MANUAL ON
- X=3 Parameter to set the state to MANUAL OFF
- X=4 Parameter to set the state to OVERRIDE ON
- X=5 Parameter to set the state to OVERRIDE OFF
- X=NULL Parameter to return the current state

Return Values

The command will return the updated condition of the gating in the same format as the command.

GRATIO

This command changes or reports back the setting of the gate ratio.

[DEVICE] **GRATIO** <X>

Explanation

<X>

- X=0-50 Parameter to set the Gate Ratio (in dB)
- X=NULL Parameter to return the current gate ratio

Return Values

The command will return the updated gate ratio (0–50) in the same format as the command.

HOLD

This command changes or reports back the setting of the hold time.

[DEVICE] **HOLD** <X>

Explanation

<X>

- X=100-8000 Parameter to set the hold time (in milliseconds)
- X=NULL Parameter to return the current hold time

Return Values

The command will return the updated hold time in the same format as the command.

HOOK

This command sends a momentary interruption in the line seizure (hook flash) to the telephone line.

[DEVICE] **HOOK**

Return Values

If hook flash succeeded, the following is returned out the port: [DEVICE] HOOK 0

Example

The following command request hook flash from device 30:
#30 HOOK

The following is returned out the serial port: #30 HOOK

HOOKD

This command controls and reports the Hook Duration of the unit.

[DEVICE] **HOOKD** <X>

Explanation

<X>

X=1	Parameter to set Hook Duration to 50ms
X=2	Parameter to set Hook Duration to 500ms
X=NULL	Parameter to report back the current state

Return Values

The command returns the current hook duration of the unit in the same format as the command. If the sent command changes the hook duration of the unit, the updated hook duration is returned.

LFP

This command locks, unlocks, or returns the current state of the front panel from the serial port.

[DEVICE] **LFP** <X>

Explanation

<X>

X=0	Parameter to unlock the front panel.
X=1	Parameter to lock the front panel
X=2	Parameter to toggle the state from one state to the other (regardless of current state)
X=NULL	Parameter to return the current state of the front panel

Return Values

The command will return the updated condition of the front panel.

LMO

This command changes or reports back the setting of the last microphone on mode for each AP400.

[DEVICE] **LMO** <X>

Explanation

<X>

X=0	Parameter to set the mode to OFF
X=1	Parameter to set the mode to Microphone #1
X=2	Parameter to set the mode to Last Microphone On
X=NULL	Parameter to return the current mode

Return Values

The command will return the updated mode for the selected AP400 in the same format as the command.

LVL

This command reports back the level for a given channel.

[DEVICE] **LVL** <CH> <W>

Explanation

<CH>

CH= 1-4	Parameter to apply to the specified channel
CH= A-D, T	Parameter to apply to the specified channel

<W>

W= I	Parameter to specify an input meter
W= 0	Parameter to specify an output meter
W= A	Parameter to specify an adaptive ambient meter (channels 1-4 only)

Return Values

The command will return the input level of the channel in the same format as the command.



MASTER

This command selects or returns the current mode of the AP400 from the serial port.

[DEVICE] **MASTER** <X>

Explanation

<X>

X=1	Parameter to designate the AP400 as master-single
X=3	Parameter to designate the AP400 as slave
X=4	Parameter to designate the AP400 as master-linked
X=NULL	Parameter to return the current mode

Return Values

The command will return the updated condition of the mixer in the same format as the command.

MDMODE

This command enables or disables the modem mode for the AP400. When the modem mode is enabled, the modem initialization string is sent out the serial port and the serial port then requires a password before a command is processed. Note: The default password is a carriage return (enter). If the password is forgotten, it can be cleared back to a carriage return via the front panel.

[DEVICE] **MDMODE** <X>

Explanation

<X>

X=0	Sets modem mode to OFF
X=1	Sets modem mode to ON

Return Values

The command will return the updated condition (1=On, 0=Off) of the pin in the same format as the command.

After five minutes of serial inactivity, the password will be requested to continue serial activity. For immediate password protection, see BYE command (page 48).

MEQ

This command changes or reports back the state of the equalizer adjustment for a microphone input.

[DEVICE] **MEQ** <CH> <BAND> <X>

Explanation

<CH>

CH= 1-4	Parameter to apply to the specified microphone channel
CH= *	Parameter to apply command to all microphone channels

<BAND>

BAND=H, M, L	Parameter to select which band is modified
--------------	--

<X>

X= -12 -12	Parameter to set level of the band
X=NULL	Parameter to return the current level

Return Values

The command will return the updated condition of the equalizer in the same format as the command.

MHP

This command changes or reports back the state of the high pass filter for a microphone.

[DEVICE] **MHP** <CH> <X>

Explanation

<CH>

- CH= 1-4 Parameter to apply to the specified microphone channel
- CH= * Parameter to apply command to all microphone channels

<X>

- X=0 Parameter to set the state to OFF
- X=1 Parameter to set the state to ON
- X=NULL Parameter to return the current state

Return Values

The command will return the updated condition (On=1, Off=0) of the high pass filter in the same format as the command.

MINIT

This command sets or reports the current setting for the initialization string sent to the modem when in modem mode.

[DEVICE] **MINIT** <STRING>

Explanation

STRING can be any character combination up to 30 characters. If STRING is not specified the command returns the currently assigned string. To specify no initialization string, set STRING to "CLEAR."

Return Values

The command will return the updated string in the same format as the command was issued.

MLINE

This command changes or reports back how much gain is applied to the microphone input. The three settings are 0dB, 25dB, and 55dB.

[DEVICE] **MLINE** <CH> <X>

Explanation

<CH>

- CH= 1-4 Parameter to apply to the specified microphone channel
- CH= * Parameter to apply command to all microphone channels

<X>

- X=1 Parameter to set the state to 55dB gain
- X=2 Parameter to set the state to 25dB gain
- X=3 Parameter to set the state to 0dB (line level)
- X=NULL Parameter to return the current state

Return Values

The command will return the updated condition of the gain applied in the same format as the command.

MMAX

This command changes or reports back the setting for the maximum number of microphones on each AP400.

[DEVICE] **MMAX** <X>

Explanation

<X>

- X=0 Parameter to set the maximum to no limit
- X=1-8 Parameter to set the maximum number of microphones allowed on
- X=NULL Parameter to return the maximum number of microphones allowed on

Return Values

The command will return the updated maximum number of microphones allowed on for the selected AP400 in the same format as the command.

MPASS

This command sets the current password for modem mode. Note: The default password is a carriage return (enter). If the password is forgotten, it can be cleared back to a carriage return via the front panel.

[DEVICE] **MPASS** <STRING>

Explanation

STRING can be any character combination up to 8 characters. If STRING is not specified the command returns the currently assigned string. To specify no initialization string, set STRING to "CLEAR."

Return Values

Once the command is given, the unit responds by echoing back the command.

MTRX

This command programs or reports the configuration of a routed input. The data is in a hex format. See the matrix configuration table for specific routing information.

[DEVICE] **MTRX** <INPUT> <OUTPUTMIX>

Explanation

<INPUT>

Input=1-25 selects the input to be routed to the mix outputs.

Input	Input word assignment
1	Mic input 1 post gate
2	Mic input 2 post gate
3	Mic input 3 post gate
4	Mic input 4 post gate
5	Reserved
6	Reserved
7	Reserved
8	Reserved
9	Line input A
10	Line input B
11	Line input C
12	Line input D
13	Subbus 1
14	Reserved
15	G-Link X
16	G-Link Y
17	G-Link Z
18	Mic input 1 pregate
19	Mic input 2 pregate
20	Mic input 3 pregate
21	Mic input 4 pregate
22	Telco input pregate
23	Reserved
24	Reserved
25	Reserved

<OUTPUTMIX>

OUTPUTMIX=hex word The selected input will be routed to the outputs indicated.

OUTPUTMIX=null Mix Command to return the current setting for the input.

<OUTPUTMIX>Note:

When entering the hex value of the <OUTPUTMIX>, it is not necessary to add the leading zeros, only zeros that follow the value, as in examples 1 & 2, below.

Example 1

The following command routes Pregate Mic Input 1 audio to Output 1. This command applies only to the box the serial cable connects to, since a device is not specified.

G-Link Z-BUS	G-Link Y-BUS	G-Link X-BUS	Reserved	Sub BUS 1	Output D	Output C	Output B	Output A	Reserved	Reserved	Reserved	Telco	Output 4	Output 3	Output 2	Output 1
16	15	14	13	12	11	10	9	8	7	6	5	4	3	2	1	0
0	0	0	0	0	0	0	0	0	0	0	0	0	0	0	0	1

Example 1. OUTPUTMIX matrix #34 MTRX 18 1

Example 2

The following command routes Mic Input 1 Post Gate audio to Outputs A, B, and C, and to the G-Link X-bus.

G-Link Z-BUS	G-Link Y-BUS	G-Link X-BUS	Reserved	Sub BUS 1	Output D	Output C	Output B	Output A	Reserved	Reserved	Reserved	Telco	Output 4	Output 3	Output 2	Output 1
16	15	14	13	12	11	10	9	8	7	6	5	4	3	2	1	0
0	0	1	0	0	0	1	1	1	0	0	0	0	0	0	0	0

Example 2. OUTPUTMIX matrix MTRX 1 4700

Return Values

The command will return the updated condition of the matrix for the selected input in the same format as the command was issued.

MUTE

This command changes or reports the state of mute for a given channel.

[DEVICE] **MUTE** <CH> <W> <X>

Explanation

<CH>

- CH= 1-4 Parameter to apply to the specified microphone channel
- CH= A-D, T Parameter to apply to select the line channel
- CH= 1 Parameter to apply to select the subbus channel
- CH= * Parameter to apply to all microphone channels

<W>

- W= S Parameter to set subbus
- W=I Parameter to set input
- W=0 Parameter to set output

<X>

- X=0 Set mute to OFF
- X=1 Set mute to ON (mute the selected channel)
- X=2 Parameter to toggle the state from one state to the other (regardless of current state)
- X=NULL Report the current state of mute for the selected channel

Return Values

The command will return the mute status (On=1, Off=0) in the same format as the command.

NLP

This command changes or reports back the state of the nonlinear processing for a microphone.

DEVICE] **NLP** <CH> <X>

Explanation

<CH>

- CH= 1-4 Parameter to apply to the specified microphone channel
- CH= * Parameter to apply command to all microphone channels

<X>

- X=0 Parameter to set the state to OFF
- X=1 Parameter to set the state to soft
- X=2 Parameter to set the state to medium
- X=3 Parameter to set the state to aggressive
- X=NULL Parameter to return the current state

Return Values

The command will return the updated condition (0=Off, 1=Soft, 2=Medium, 3=Aggressive) of the nonlinear processing in the same format as the command.

NOM

This command changes or reports back state of NOM attenuation for each channel.

[DEVICE] **NOM** <CH> <X>

Explanation

<CH>

CH= 1-4 Parameter to apply to the specified direct output channel

CH= A-D, T Parameter to apply to the specified line output

<X>

X=0 Parameter to set NOM attenuation to OFF

X=1 Parameter to set NOM attenuation to ON

X=NULL Parameter to return the current state of NOM attenuation

Return Values

The command will return the updated condition (On=1, Off=0) of NOM attenuation for the selected channel in the same format as the command.

NULL

This command sends a short noise burst down the telephone line and forces the AP400 to adapt to the telephone line.

[DEVICE] **NULL**

Return Values

If the NULL succeeds, the following is returned out the serial port: [DEVICE] NULL

If the NULL fails, the following is returned out the serial port: [DEVICE] NULL

OFFA

This command changes or reports back the setting of off attenuation.

[DEVICE] **OFFA** <X>

Explanation

<X>

X=0-50 Parameter to set the amount of off attenuation (in dB)

X=NULL Parameter to return the current value of off attenuation

Return Values

The command will return the updated value of off attenuation in the same format as the command.

PAA

This command selects or returns the current status of the PA adaptive mode.

[DEVICE] **PAA** <X>

Explanation

<X>

X=0 Parameter to select PA adaptive mode to OFF

X=1 Parameter to select PA adaptive mode to ON

X=NULL Parameter to return the current mode

Return Values

The command will return the updated condition (On=1, Off=0) of the PA adaptive mode in the same format as the command.

PCMD

This command programs or returns the program of the GPIO control pins from the serial port. COMMAND can be any valid command. These values are not part of the preset and do not change when presets are loaded.

[DEVICE] **PCMD** <LOCATION> <COMMAND>

Explanation

<LOCATION>

LOCATION=1	Control pin 1 active
LOCATION=2	Control pin 1 inactive
LOCATION=3	Control pin 3 active
LOCATION=4	Control pin 3 inactive
LOCATION=5	Control pin 5 active
LOCATION=6	Control pin 5 inactive
LOCATION=7	Control pin 7 active
LOCATION=8	Control pin 7 inactive
LOCATION=9	Control pin 9 active
LOCATION=10	Control pin 9 inactive
LOCATION=11	Control pin 11 active
LOCATION=12	Control pin 11 inactive
LOCATION=13	Control pin 13 active
LOCATION=14	Control pin 13 inactive
LOCATION=15	Control pin 15 active
LOCATION=16	Control pin 15 inactive

<COMMAND>

COMMAND=String	Pin will execute string when actuated
COMMAND=NULL	Parameter to return the current programming for the pin
COMMAND=Clear	Parameter to clear current programming (do nothing state)

COMMAND LIST: AA, AD, AGC, CHAIRO, EQ, GAIN, GMODE, HOOK, LFP, MUTE, NULL, PRESET, TE

Return Values

The command will return the updated condition of the pin in the same format as the command. If the command did not alter the

state, the command returns the current command for which the pin is programmed.

Example

The PCMD command line contains both the PCMD command and the command being programmed. To program AP400 unit 0 control/status pin 1 to toggle mute on mic 1, the command would appear as follows:

```
#30 PCMD 1 MUTE 1 I 2
```

(toggles mute to the opposite state: ON to OFF and vice-versa)

PEVNT

This command programs or returns the program of the GPIO status pins from the serial port. The command line follows the same format as shown in the PCMD example (previous page).

[DEVICE] **PEVNT** <LOCATION> <EVENT>

Explanation

<LOCATION>

LOCATION=1	Status pin 2 active
LOCATION=2	Status pin 2 inactive
LOCATION=3	Status pin 4 active
LOCATION=4	Status pin 4 inactive
LOCATION=5	Status pin 6 active
LOCATION=6	Status pin 6 inactive
LOCATION=7	Status pin 8 active
LOCATION=8	Status pin 8 inactive
LOCATION=9	Status pin 10 active
LOCATION=10	Status pin 10 inactive
LOCATION=11	Status pin 12 active
LOCATION=12	Status pin 12 inactive
LOCATION=13	Status pin 14 active
LOCATION=14	Status pin 14 inactive
LOCATION=15	Status pin 16 active
LOCATION=16	Status pin 16 inactive

<EVENT>

EVENT=String	Pin will execute string when actuated
EVENT=NULL	Parameter to return the current programming for the pin
EVENT=Clear	Parameter to clear current programming (do nothing state)

EVENT LIST: AA, AD, AGC, CHAIRO, EQ, GAIN, GMODE, LFP, MUTE, PRESET, TE

Return Values

The command will return the updated condition of the pin in the same format as the command. If the command did not alter the state, the command returns the current event for which the pin is programmed.



Preset Command Note: PRESET has two status parameters which can be set in a PEVNT command line: preset and NOT preset. To indicate NOT preset, add "!" to the end of the string. For example, this could be used to show when PRESET 1 occurs and then shut off if any other preset is selected. You would enter PRESET 1 in the active location and PRESET 1! in the inactive location for the desired pin.



PP

This command changes or reports back the state of the phantom power for a microphone.

[DEVICE] **PP** <CH> <X>

Explanation

<CH>

- CH= 1-4 Parameter to apply to the specified microphone channel
- CH= * Parameter to apply command to all microphone channels

<X>

- X=0 Parameter to set the state to OFF
- X=1 Parameter to set the state to ON
- X=NULL Parameter to return the current state

Return Values

The command will return the updated condition (On=1, Off=0) of the phantom power in the same format as the command.

PRESET

This command selects or reports the current preset configuration used by the AP400.

[DEVICE] **PRESET** <X>

Explanation

<X>

- X=1-6 Sets the preset to the number specified
- X=NULL Parameter to return the current preset

Return Values

The command will return the current preset. If the command changed the preset, the updated preset is returned.

REFSEL

This command selects or returns the output to be used as the EC Reference and PA (speaker output).

[DEVICE] **REFSEL** <X> <OUTPUT>

Explanation

<X>

- X=1 Parameter to select the EC Reference and PA (speaker output)
- X=2 Parameter to select the G-Link EC Ref bus

<OUTPUT>

- OUTPUT=1-4 Parameter to select 1-4 as the EC reference and PA (speaker output)
- OUTPUT=A-D Parameter to select A-D as the EC reference and PA (speaker output)
- OUTPUT=E Parameter to select G-Link EC Ref bus as the EC Reference and PA (speaker output)
- OUTPUT=F Parameter to select none
- OUTPUT=NULL Parameter to return the EC reference and PA (speaker output) value

Return Values

The command will return the updated condition of the reference and PA (speaker output) select in the same format as the command.

RING

This command reports the presence of a ring on the Telco port.
(This is an indication only.)

[DEVICE] **RING**

Return Value

The Ring is sent if a valid ring has been sensed on the Telco line: [DEVICE] RING

RXRD

This command controls or reports the Receive Reduction control of the unit.

[DEVICE] **RXRD** <X>

Explanation

<X>

X=0	Parameter to set Receive Reduction to OFF
X=1	Parameter to set Receive Reduction to ON
X=2	Parameter to toggle the current state
X=NULL	Parameter to report back the current state

Return Values

The command returns the updated connection state of the unit in the same format as the command.

TAMODE

This command controls or reports the Telephone Adapt Mode control of the unit.

[DEVICE] **TAMODE** <X>

Explanation

<X>

X=0	Parameter to set Telephone Adapt Mode to Auto
X=1	Parameter to set Telephone Adapt Mode to Burst
X=NULL	Parameter to report back the current state

Return Values

The command returns the updated connection state of the unit in the same format as the command.

TE

This command controls or reports the connection status of the unit.

[DEVICE] **TE** <X>

Explanation

<X>

X=0	Parameter to set the unit to disconnect from the line
X=1	Parameter to set the unit to connect to the line
X=2	Parameter to toggle the state from one state to the other
X=NULL	Parameter to report back the current state

Return Value

If the current state is ON, the following is returned out the serial port: [DEVICE] TE 1

If the current state is OFF, the following is returned out the serial port: [DEVICE] TE 0



TERL

This command reports back the telephone echo return loss (TERL) for the AP400 in decibels.

[DEVICE] **TERL**

Example

If the current TERL level is 10 dB, the following is returned out the serial port: [DEVICE] TERL 10

TERLE

This command reports back the telephone echo return loss enhancement (TERLE) for the AP400 in decibels.

[DEVICE] **TERLE**

Example

If the current TERLE level for the telephone canceller is 20dB, the following is returned out the serial port: [DEVICE] TERLE 20

TOUT

This command sets or reports the current inactivity timeout before returning to the title screen used by the unit.

[DEVICE] **TOUT** <X>

Explanation

<X>

X=0	Disables inactivity timeout
X=1-15	Sets the number of minutes specified
X=NULL	Parameter to return the current number of minutes

Return Values

The command will return the current timeout value. If the command changed the timeout, the updated timeout is returned.

UID

This command returns the unique ID number, the device type and the device number of the AP400. This command is read only. The unique ID number is preprogrammed at the factory and is unique to the unit, while the device number is set by the user at the time of installation.

[DEVICE] **UID**

Return Values

UID returns the device type, device number and unique ID number. The unique ID is composed of an eight-digit hex number assigned at the factory to uniquely identify the unit.

Example

The following command requests the unit ID from device 31: #31 UID

The following is returned out the serial port: #31 UID A4EF906C

VER

This command returns current version of firmware. This version is unique to a released version of firmware and is comprised of the DSP, the FPGA, and HC11 firmware. This command is read only.

[DEVICE] **VER**

Return Values

VER returns the version of firmware in the same format as the command. The Version is composed of a major version number, followed by a period and a minor version number.

Example

The following command requests the firmware version from device 31: #31 VER

The following is returned out the serial port: #31 VER 2.0

Appendix F: Worksheets

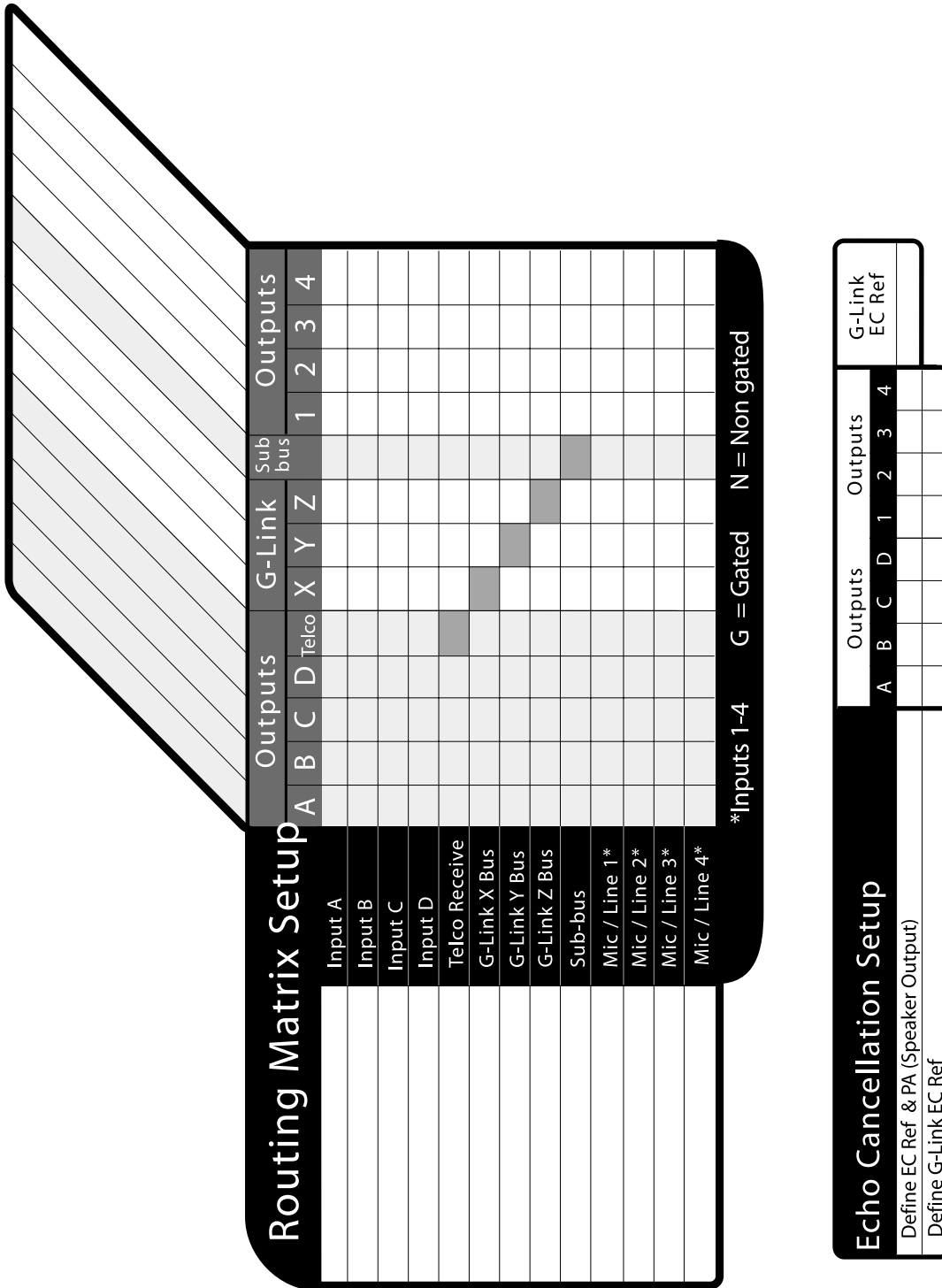

Figure F.1. Routing matrix worksheet



AP400 Parameters Worksheet													
System Wide Parameters							Auto Mix Parameters						
Program Parameter	Selection Range	1	2	3	4	A	B	C	D	Program Parameter	Selection Range	1	2
Preset	1 - 6									PA Adaptive	On, Off		
Look Front Panel	On, Off									Maximum No. of Mics	Off, 1-8 (4)		
Set Passcode	Any Five Front Panel Keys									First Mic Priority	On, Off		
Device ID No.	0 - 7									Last Mic Mode	Last On, Off, or Mic 1		
Unit ID No.	Factory Programmed									Gate Ratio	0 - 50 dB (15)		
Mixer Mode	Master-Single/Linked, Slave									Off Attenuation	0 - 50 dB (12)		
RS-232 Baud Rate	9.6, 19.2, 38.4kbps									Hold Time	1 - 8.0 seconds (.3)		
RS-232 Flow Control	On, Off									Decay Rate	Slow, Medium, Fast		
Modem Mode	On, Off									Manual Ambient	0dB to -70dB (-30)		
Clear Modem Password	Enter												
Timeout	0 - 15 (10)												
Auto Answer	On, Off												
Auto Disconnect	Off, Loop Drop, Call Prog, LD + CP												
*Telco Adapt Mode	Auto, Burst												
*Hook Duration	50 ms., 500ms												
*Receive Reduction	On, Off												
Input Channel													
Program Parameter	Selection Range	1	2	3	4	A	B	C	D	Program Parameter	Selection Range	1	2
Input Gain Adjust	-20dB to 20dB (0)												
Subbus Attenuation	0dB to -20dB (-6dB)												
Input Type	Mic 55dB, Mic 25dB, Line												
Microphone Activation	Auto, Override On/Off, Manual On/Off												
Mute	On, Off												
Phantom Power	On, Off												
AGC	On, Off												
High-Pass Filter	On, Off												
EQ	On, Off												
*Low Band EQ	-12dB to 12dB (0)												
*Mid Band EQ	-12dB to 12dB (0)												
*High Band EQ	-12dB to 12dB (0)												
Chairman Mic	On, Off												
Adaptive Ambient	On, Off												
Echo Cancellation	On, Off												
NLP	Off, Soft, Medium, Aggressive												
Output Channel													
Program Parameter	Selection Range	1	2	3	4	A	B	C	D	Program Parameter	Selection Range	1	2
Output Gain Adjust	-20dB to 20dB (0)												
Mute	On, Off												
NOM	On (A - C, Telco) or Off (1 - 4, D)												

* Set up only by serial port

Figure F.2. Programming worksheet

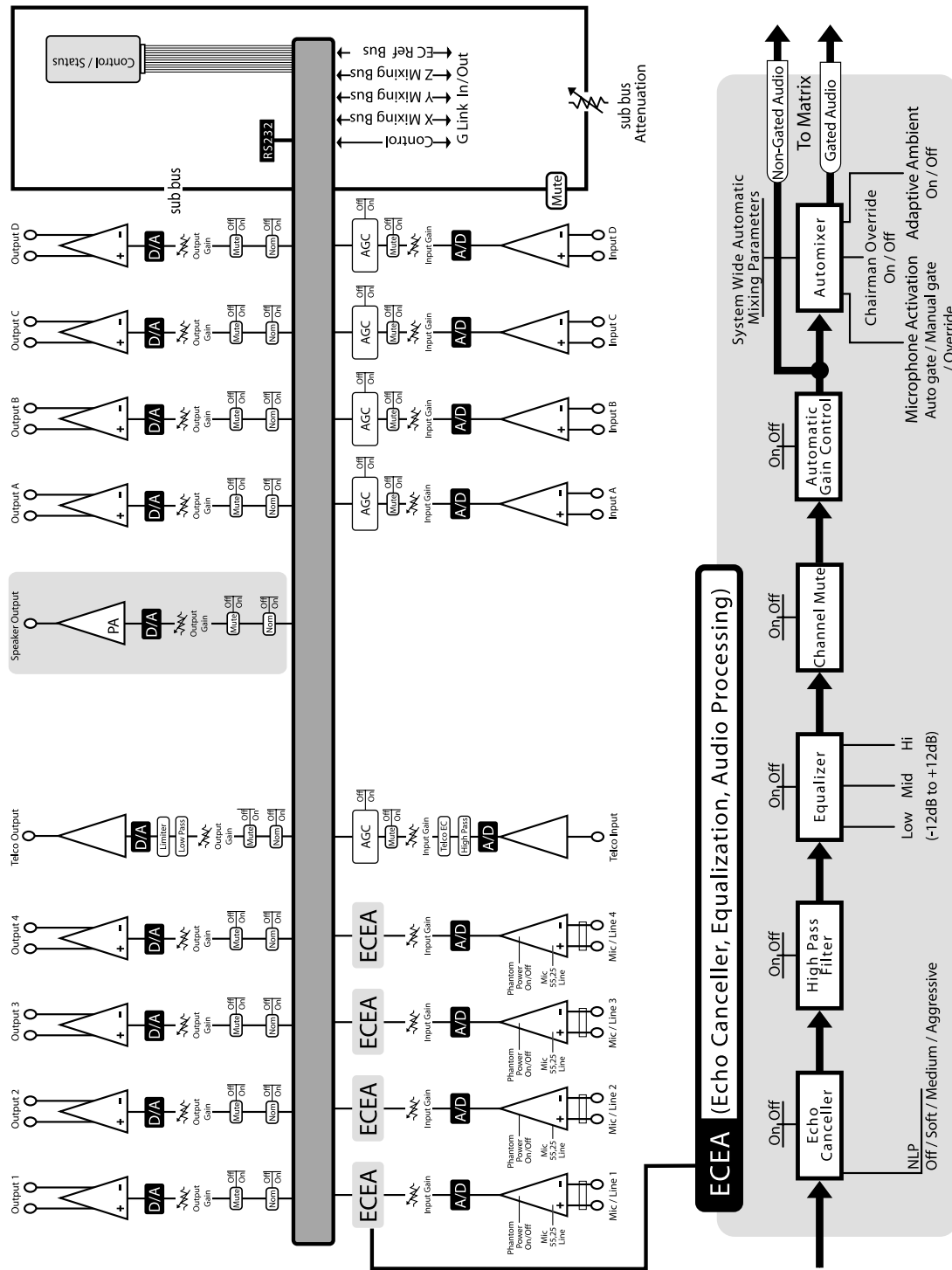

Figure F.3. Audio flow block diagram

Index**A**

adaptive ambient 21, 23, 24
ambient level 1, 24
ambient noise 24
AP-Ware 31
automatic gain control 1, 10, 24, 25, 44

B

baud rate 22, 48

C

chairman override 24, 48
clear password 22
command line 44
connector pinouts 42
Control/Status 42

D

default meter 22, 49
delay 22
device ID 13, 18, 44
device type 13, 44, 65
Distributed Echo Cancellation 2
DSP 2

F

filter 23, 24
first mic priority 18, 51
flow control 22, 51

G

G-Link 10, 12
 connections 12
 reference 28
G-Link In 12
G-Link Out 12
gain 2, 23, 25, 26, 33, 52
 gain adjust 23, 26
gate 18

activation 23
adaptive ambient 24
auto-gate 23
decay rate 18, 21, 49
gate ratio 18, 53
hold time 18, 53
manual off 23
manual on 23
off attenuation 18, 20, 60
PA adaptive mode 18, 19, 60
GPIO 61, 62

H

high pass filter 56

I

Inputs A-D 10, 25

L

last mic mode 18
LCD menu 16, 22, 43
LCD menu tree 16
LCD programming 15

M

maximum number of mics 18
Meter menu 29
modem 22, 48, 55, 56, 57
mute 33, 42, 59

N

NOM 26, 60
non-linear processing 25

O

outputs 1-4 26



P

password 22, 48, 55, 57
phantom power 23, 63

R

remote control 9
routing matrix 66
RS-232 1, 22, 24, 42, 43, 48

S

serial commands 43, 45

T

telco 23, 25, 26, 64