

ZANUSSI

BUILT-IN
DOUBLE OVEN
MODEL ZDF 866

INSTRUCTION BOOKLET

Please read this instruction booklet before using the oven

Important Safety Information



You MUST read these warnings carefully before installing or using the oven. If you need assistance, contact our Customer Care Department on 01635 521313

Installation

- This oven must be installed by **qualified personnel** to the relevant British Standards.
- This oven is heavy. Take care when moving it.
- Remove **all packaging**, both inside and outside the oven, before using the oven.
- Do not attempt to modify the oven in any way.

Child Safety

- This oven is designed to be operated by adults. Do not allow children to play near or with the oven.
- The oven gets hot when it is in use. Children should be **kept away** until it has cooled.

During Use

- This oven is intended for domestic cooking only. It is not designed for commercial or industrial purposes.
- Never line any part of the oven with **aluminium foil**.
- Do not allow heatproof cooking material, e.g. roasting bags, to come into contact with oven elements.
- **Never** place plastic or any other material which may melt in or on the oven.
- **Do not** place sealed cans or aerosols inside the oven. They may explode if they are heated.
- **Do not** hang towels, dishcloths or clothes from the oven or its handle.
- **Do not** use this oven if it is in contact with water and never operate it with wet hands.
- Take **great care** when heating fats and oils as they will ignite if they become too hot.
- **Always** use oven gloves to remove and replace food in the oven.

- Ensure that all control knobs are in the **OFF** position when not in use.
- **Do not** leave cookware containing foodstuffs, e.g. fat or oil in or on the oven in case it is inadvertently switched **ON**.
- When using other electrical appliances, ensure the cable does not come into contact with the hot surfaces of the oven.

Maintenance and Cleaning

- **Only** clean this oven in accordance with the instructions.
- The oven should be kept clean at all times. A build-up of fats or other foodstuffs could result in a fire, especially in the grill pan.
- Always allow the oven to cool down and switch off the electrical supply before carrying out any cleaning or maintenance work.

Service

- This oven should only be repaired or serviced by an authorised Service Engineer and only genuine approved spare parts should be used.

Environmental Information

- After installation, please dispose of the packaging with due regard to safety and the environment.
- When disposing of an old appliance, make it unusable, by cutting off the cable. Remove any door catches, to prevent small children being trapped inside.

Keep this instruction book for future reference and ensure it is passed on to any new owner.

Contents

For the User

Important safety information	Page 3
Description of the oven	Page 5
Controls	Page 6
24 hour Clock and Timer	Page 7
Before the First Use	Page 9
Using the Oven	Page 9
Using the Fan Oven	Page 11
Cooking Chart	Page 12
Defrosting	Page 14
Using the Lower Oven	Page 15
Grilling	Page 17
Cleaning the Oven	Page 18
Care of Catalytic Liners	Page 20
Replacing the Oven Light	Page 20
Cleaning the Hinged Grill	Page 21
What happens if something goes wrong	Page 22
Service and Spare Parts	Page 23

For the Installer

Peace of Mind for 24 months	Page 23
Technical Data	Page 24
Electrical Connection	Page 24
Installation	Page 25

Guide to Use the Instruction Book

The following symbols will be found in the text to guide you throughout the Instructions:



Safety Instructions



Step by step instructions for an operation



Hints and Tips

CE This appliance complies with the following **E.E.C. Directives**:
* 73/23 - 90/683 (Low Voltage Directive);
* 93/68 (General Directives);
* 89/336 (Electromagnetical Compatibility Directive) .
and subsequent modifications

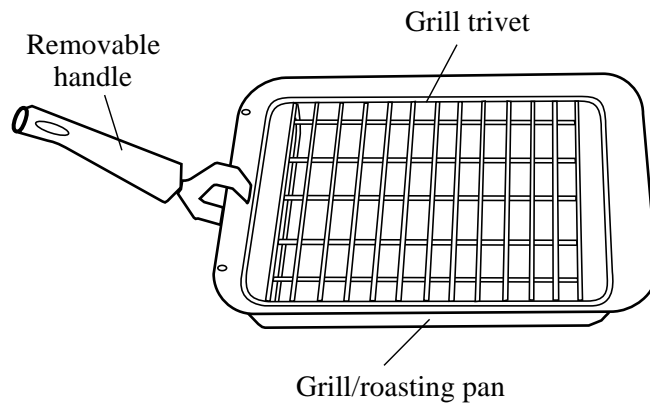
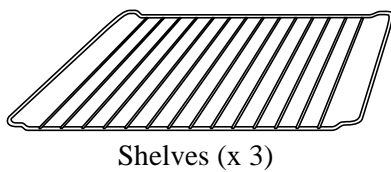
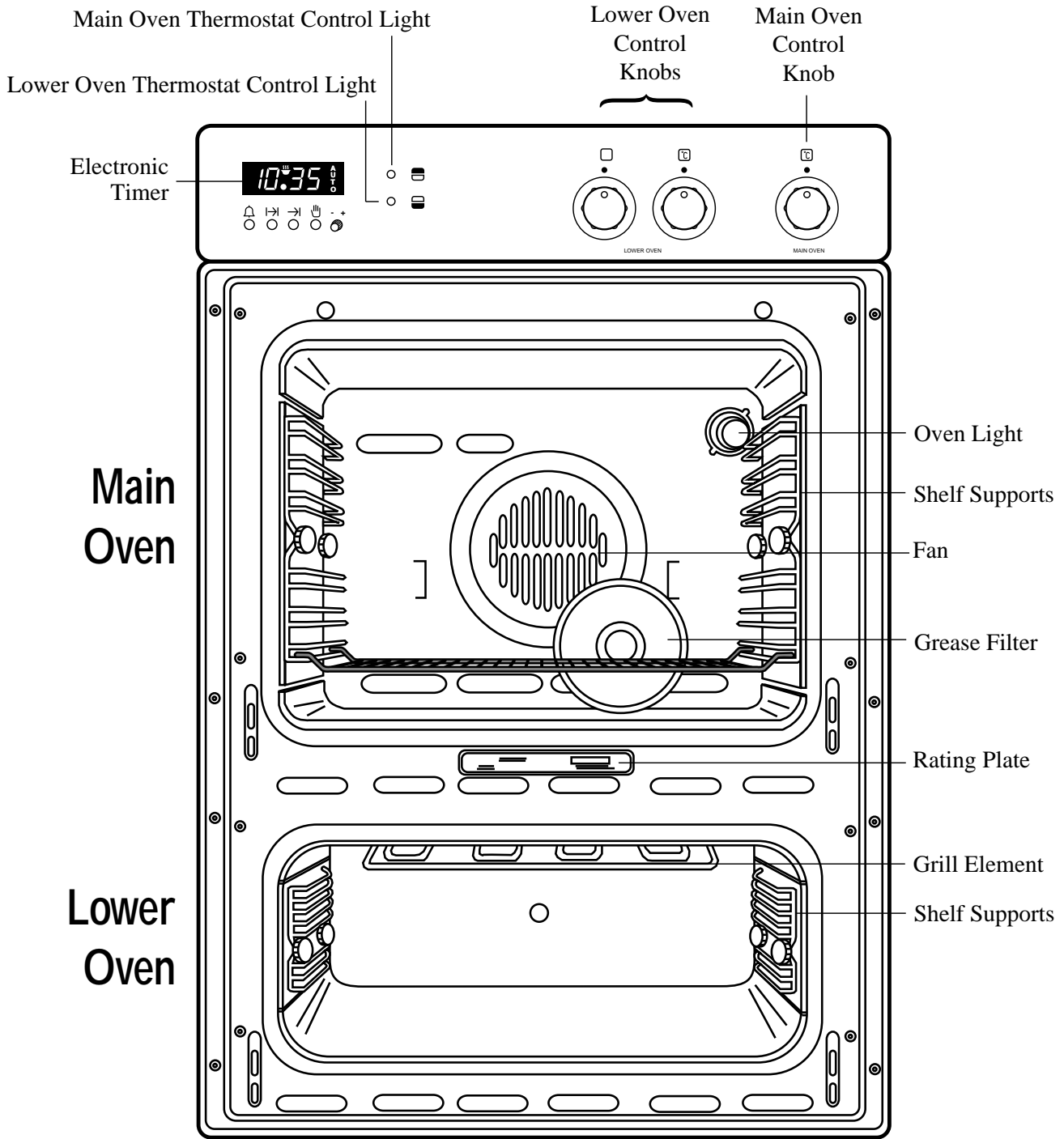

Description of the Oven



Controls

Main Oven



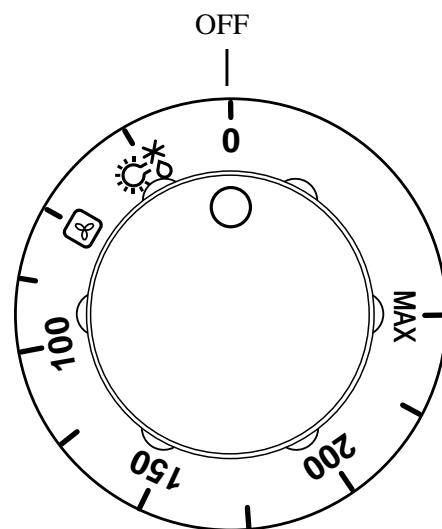

Oven Function and Temperature Control Knob

-  Oven Light and Defrost Setting - The oven light will be on without any cooking function. This setting is intended to assist in thawing of frozen food (see page 17).
-  Fan cooking - This allows you to roast or roast and bake simultaneously using any shelf, without flavour transference. Temperature can be adjusted by turning the knob on the required setting.



Lower Oven

Oven Function Control Knob

-  Conventional cooking - The heat comes from both the top and bottom element, ensuring even heating inside the oven.
-  Top heating element - The heat comes from the top of the oven only.
-  Bottom heating element - The heat comes from the bottom of the oven only.
-  Grill element - Can be used for grilling small quantities.

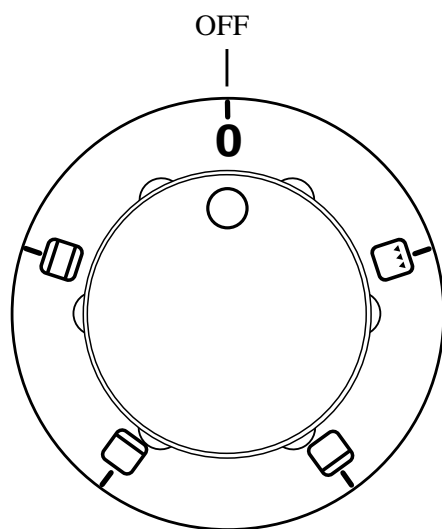

Thermostat Control Knob

Turn the thermostat control knob clockwise to select temperatures between 50°C and 250°C (MAX).

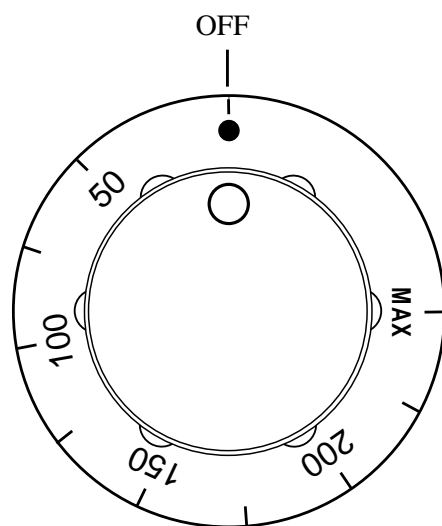

24 hour Clock and Timer

The electronic timer can be used to programme the main oven only.

The electronic timer can indicate the time of day and automatically operate the oven.

Before the oven can be operated, the time of day must be set on the electronic timer.

In case of loss of power, all the settings (time of day, set program or program in operation), will be cancelled. When the power is restored, the numbers on the display will flash, and the timer has to be reset.

Please note that this is a 24 hour clock. For example, 2pm is shown as 14:00.

 Minute minder

 Cooking duration

 End of cooking time



 Manual function

 Cookpot symbol - This will be displayed when a program is in operation.

 Auto symbol - This will be displayed when the oven has been programmed for automatic operation.

 Time setting knob



TO SET THE TIME OF DAY

Press buttons  and , and at the same time turn the time setting knob until the correct time of day is displayed.

TO SET THE MINUTE MINDER

Press button  and at the same time turn the setting time knob until the duration time is displayed (maximum 23 hours, 59 minutes).

Our diagram shows the timer set for 35 minutes. After a few seconds the time of day will show in the display.

To check the number of minutes remaining, press the  button. At the end of the timed period an alarm will sound. To switch off the alarm press button .

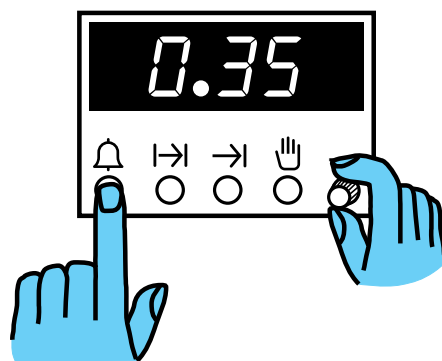
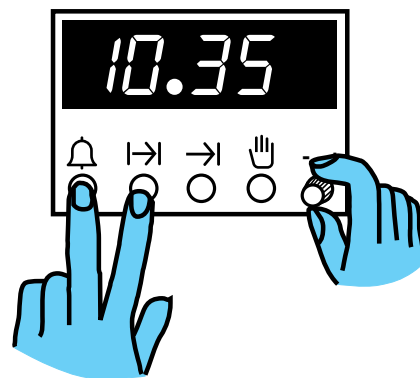
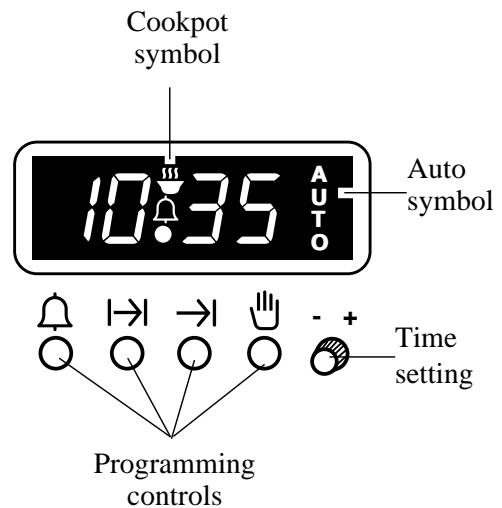

MANUAL FUNCTION

Press button  to set the oven for manual function.

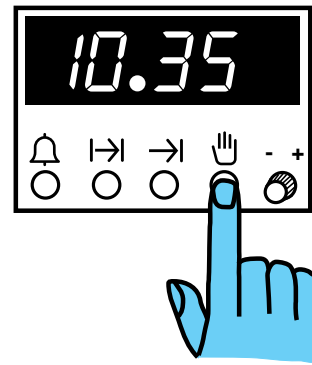

TO SET THE TIMER TO SWITCH OFF ONLY

This is useful if you want to begin cooking immediately but have the oven switch off automatically.

1. Set the oven function control knob and the thermostat control knob on the required settings.
2. Place food in the oven.
3. Press button  and, at the same time, turn the time setting knob until the required cooking duration is displayed.

Our diagram shows the timer set for 1 hour 10 minutes.

At the end of the cooking time the oven will switch off, an alarm will sound. To switch off the alarm press button .

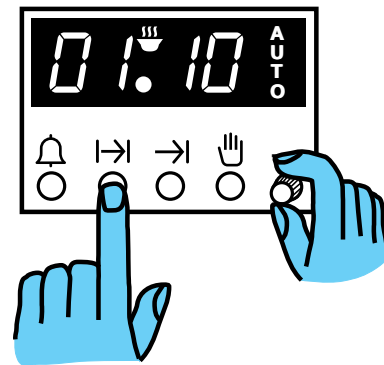



TO SET THE TIMER TO SWITCH THE OVEN ON AND OFF

1. Ensure the clock is showing the right time of day.
2. Carry out steps 1, 2 and 3 as explained in "To set the timer to switch off only".
3. Press button  and at the same time turn the time setting knob until the end cooking time is displayed.

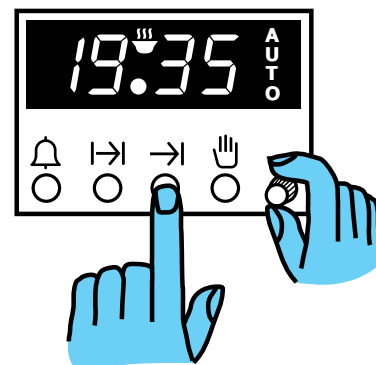
Our diagram shows the end cooking time set for 7:35 pm.



TO CANCEL A PROGRAMME

1. Press button  and, at the same time, turn the time setting knob until the cooking duration is set on "zero".
2. If the end cooking time has been set too, press button  and at the same time turn the time setting knob until the end cooking time is set on "zero".

Before the First Use



Remove **all packaging**, both inside and outside the oven, before using the oven.

Before first use, the oven should be heated without food. During this time, an unpleasant odour may be emitted. This is quite normal.



1. Set the electronic timer to manual function.
2. Switch the oven function control knob to conventional cooking
3. Set the thermostat control knob to MAX.
4. Open a window for ventilation.
5. Allow the oven to run empty for approximately 45 minutes.

The lower oven should be heated too for a short time using both the conventional cooking function and the grill function

Using the Oven



- **Always cook with the oven door closed.**
- Stand clear when opening the drop down oven door. **Do not** allow it to fall open - support the door using the door handle, until it is fully open.



- The Main Oven has six shelf levels, and is supplied with two shelves. The Lower Oven has three shelf levels. The shelf positions are casted from the bottom of the oven as shown in the diagram. It is important that these shelves are correctly positioned as shown in the diagram.
- Do not place cookware directly on the oven base.

MAIN OVEN

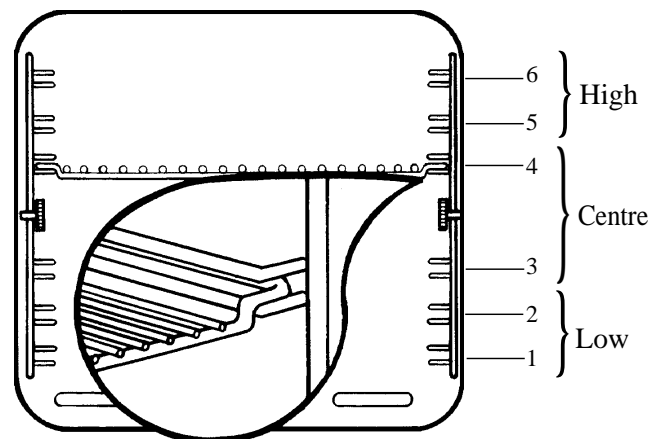

LOWER OVEN

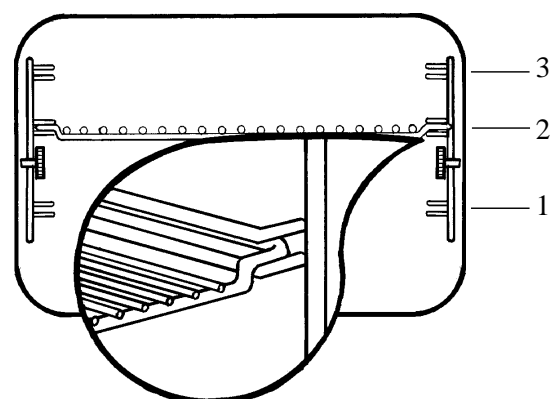

i Hints and Tips

Condensation and steam

When food is heated it produces steam in the same way as a boiling kettle. The oven vents allow some of this steam to escape. However, **always stand back from the oven when opening the oven door** to allow any build up of steam or heat to release.

If the steam comes into contact with a cool surface on the outside of the oven, e.g. a trim, it will condense and produce water droplets. This is quite normal and is not a fault with the oven.

To prevent discoloration, regularly wipe away condensation and also soilage from surfaces.

Cookware

- Use any oven proof cookware which will withstand temperatures of 250°C.
- Baking trays, oven dishes, etc. should not be placed directly against the grid covering the fan at the back of the oven, or placed on the oven base.
- Do not use baking trays larger than 30 cm x 35 cm (12 in x 14 in) as they will restrict the circulation of heat and may affect performance.

The effects of dishes on cooking results

Dishes and tins vary in their thickness, conductivity, colour, etc. which affects the way they transmit heat to the food inside them.

- A** Aluminium, earthenware, oven glassware and bright shiny utensils reduce cooking and underneath browning.
- B** Enamelled cast iron, anodized aluminium, aluminium with non-stick interior and coloured exterior and dark, heavy utensils increase cooking and underneath browning.

Using the Fan Oven (Main Oven only)

The air inside the oven is heated by the element around the fan situated behind the back panel. The fan circulates hot air to maintain an even temperature inside the oven.

The advantages of cooking with this function are:

✓ **Faster Preheating**

As the fan oven quickly reaches temperature, it is not usually necessary to preheat the oven although you may find that you need to allow an extra 5-7 minutes on cooking times. For recipes which require higher temperatures, best results are achieved if the oven is preheated first, e.g. bread, pastries, scones, souffles, etc.

✓ **Lower Temperatures**

Fan oven cooking generally requires lower temperatures than conventional cooking. Follow the temperatures recommended in the chart at page. 15. Remember to reduce temperatures by about 20-25°C for your own recipes which use conventional cooking.

✓ **Even Heating for Baking**

The fan oven has uniform heating on all runner positions. This means that batches of the same food can be cooked in the oven at the same time. However, the top shelf may brown slightly quicker than the lower one. This is quite usual. There is no mixing of flavours between dishes.

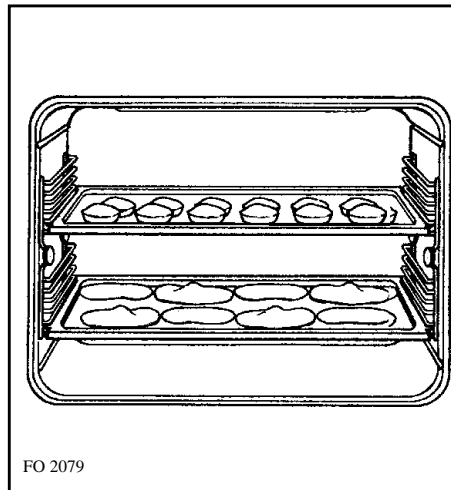

How to Use the Fan Oven

Turn the oven function control knob to the required temperature.

THINGS TO NOTE

- The oven light will come on when the oven function control knob is set.
- The thermostat control light will remain on until the correct temperature is reached. It will then cycle on and off to show that temperature is being maintained.
- The cooling fan will operate continually during cooking. It may run on after the oven is switched off to keep the controls cool. This is quite normal.

NOTE

The action of the cooling fan will depend on how long the oven has been used and at what temperature. It may not switch in at all at lower temperature settings nor run on where the oven has only been used for a short time.

Cooking Chart - Fan Oven

This chart is intended as a guide only. It may be necessary to increase or decrease the temperature to suit your individual requirements. Only experience will enable you to determine the correct setting for your personal requirements.

Food	Shelf Position	Cooking Temp (°C)
Biscuits		160-190
Bread		190-220
Casseroles		130-140
Cakes: Small and queen	Shelf positions are not critical but ensure that oven shelves are evenly spaced when more than one is used.	160-170
Sponges		160-170
Madeira		140-150
Rich Fruit		130-140
Christmas		130-140
Meringues		90-100
Fish		170-190
Fruit Pies and Crumbles		170-200
Milk Puddings		130-140
Pastry: Choux } Shortcrust } Flaky } Puff }		190-200
Plate Tarts		180
Quiches/Flans		170-180
Scones		210-220
Roasting: Meat & Poultry		160-180

When roasting, ensure the meat is cooked thoroughly, use a meat thermometer if preferred to check the centre temperature has reached the required temperature (see table below).

MEAT	TEMPERATURES
Beef	Rare - 60°C Medium - 70°C Well Done - 80°C
Pork	Well Done - 80°C
Lamb	Medium - 70°C Well Done - 80°C

i Hints and Tips

Runner positions are not critical, but make sure the shelves are evenly spread.

When cooking more than one dish in the fan oven, place dishes centrally on the shelves rather than several dishes on one shelf.

When the oven is full, you may need to allow slightly longer cooking time.

A shelf may be placed on the floor of the oven. Place dishes on a shelf in this position rather than on the oven base, to allow air circulation around the food.

When the oven is full of the same food, e.g. equal trays of small cakes or equal size victoria sandwich cakes, then they will be cooked in the same time and removed from the oven together. When different sizes of trays or types of food, e.g. biscuits and cakes are cooked, they will not necessarily be ready together.

The fan oven can be used to heat foods through without thawing first, e.g. fruit tarts, mince pies, sausage rolls, and other small pastry items. Use a temperature of 190-200°C and allow 20-40 minutes (depending on the quantity of food in the oven).

The use of too high temperatures can cause uneven browning. Check with the recommendations for oven temperatures given in the cooking charts, but be prepared to adjust the temperature by 10°C if necessary. Remember to reduce temperatures by about 20-25°C for your own conventional recipes.

When roasting do use the trivet in the meat tin. Fat and meat juices will drain into the meat tin below and can be used to make gravy. The trivet also prevents splashes of fat from soiling the oven interior.

The meat tin **should not** be placed on a heated hotplate or burner as this may cause the enamel to crack.

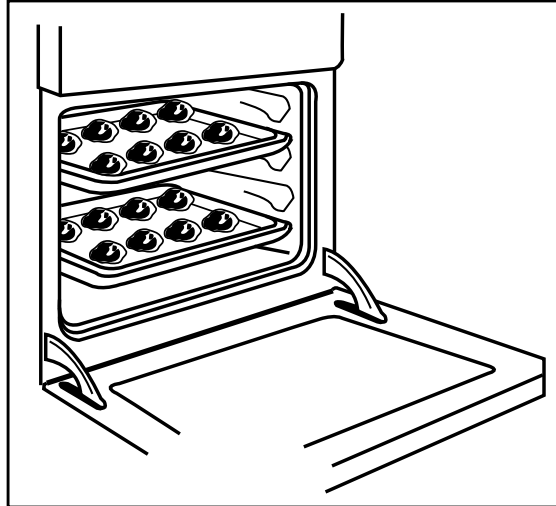

Defrosting (Main Oven only)

The oven fan operates without heat and circulates the air, at room temperature, inside the oven. This increases the speed of defrosting. However, please note that the temperature of the kitchen will influence the speed of defrosting.

This function is particularly suitable for delicate food which could be damaged by heat, e.g. cream filled gateaux, iced cakes, pastries, bread and other yeast products.

How to Use Defrosting

1. Turn the oven function control knob to .
2. Ensure the thermostat control knob is in the OFF position.

Hints and Tips

- Cover food with a lid, aluminium foil or plastic film to prevent drying out during defrosting.
- ALWAYS COOK THOROUGHLY IMMEDIATELY AFTER THAWING.
- Frozen food should be placed in a single layer when ever possible and turned over half way through the defrosting process.
- Only joints of meat and poultry up to 2 kg. (4 lb.) are suitable for defrosting in this way.

Refer to the following table for approximate defrosting times.

Food	Defrosting time (Mins)	Standing time (Mins)	Notes
Chicken 1000 g.	100-140	20-30	Place the chicken on an inverted saucer on a large plate. Defrost open and turn at half time or defrost covered with foil. Remove giblets as soon as possible.
Meat 1000 g.	100-140	20-30	Defrost open and turn at half time or cover with foil
Meat 500 g.	90-120	20-30	As above
Trout 150 g.	23-35	10-15	Defrost open
Strawberries 300 g.	30-40	10-20	Defrost open
Butter 250 g.	30-40	10-15	Defrost open
Cream 2 x 200 g.	80-100	10-15	Defrost open (cream is easy to whip even if parts of it are still slightly frozen)
Cake 1400 g.	60	60	Defrost open

The times quoted in the chart should be used as a guide only, as the speed of defrosting will depend on the kitchen temperature. For example, the colder the ambient temperature, the longer the defrosting time.

Using the Lower Oven

The Lower Oven can be used for conventional cookings or grilling.

How to Use the Conventional Oven

When using this setting, heat comes from both the top and bottom elements. This allows you to cook in a single level and is particularly suitable for dishes which require extra base browning such as pizzas, quiches and flans.

Gratins, lasagnes and hotpots which require extra top browning also cook well in the conventional oven.

This form of cooking gives you the opportunity to cook without the fan in operation.

1. Turn the oven function control knob to the required cooking function ().
2. Turn the thermostat control to the required temperature.

THINGS TO NOTE

- The oven light will come on when the oven function control knob is set.
- The thermostat control light will remain on until the correct temperature is reached. It will then cycle on and off to show that temperature is being maintained.

Top oven element only

This function is suitable for finishing cooked dishes, eg; lasagne, shepherds pie, cauliflower cheese etc.

Bottom oven element only

This function is particularly useful when blind-baking pastry or cooking pizza. It may also be used to finish off quiches or flans to ensure the base pastry is cooked through.

The Cooling Fan

- The cooling fan will operate continually during cooking. It may run on after the oven is switched off to keep the controls cool. This is quite normal.

NOTE

The action of the cooling fan will depend on how long the oven has been used and at what temperature. It may not switch in at all at lower temperature settings nor run on where the oven has only been used for a short time.

Hints and Tips

There should always be at least 2.5 cm (1") between the top of the food and the heating element. This gives the best cooking results and allows room for yeast mixtures to rise, Yorkshire puddings, etc.

When cooking cakes, pastry, scones, bread etc., place the tins or baking trays centrally below element.

Ensure that food is placed centrally on the shelf and there is sufficient room around the baking tray/dish to allow for maximum circulation.

Stand dishes on suitable sized baking trays to prevent spillage onto the oven base and to help reduce cleaning.

The material and finish of the baking tray and dishes will affect the degree of base browning of the food. Enamelware, dark, heavy or non-stick utensils increase base browning. Shiny aluminium or polished steel trays reflect the heat away and give less base browning.

DO NOT use the grill pan or meat tin as a baking tray as this will increase base browning of the food.

Because of the smaller cooking space, lower temperatures and shorter cooking times are sometimes required.

For economy, leave the door open for the shortest possible time, particularly when placing food into a preheated oven.

Grilling (Lower Oven only)



Grilling must be carried out with the oven door closed.

The grill pan handle must be removed from the pan during grilling. Always use oven gloves to remove and replace the grill pan handle.

Ensure that you **support** the grill pan when removing it from the oven.

How to Use the Grill

1. Turn the oven control function knob on .
2. Turn the thermostat control knob on the required temperature.
3. Adjust the grid and grill pan runner position to allow for different thicknesses of food. Position the food close to the element for faster cooking and further away for more gentle cooking.

Preheat the grill on a full setting for a few minutes before sealing steaks or toasting. Adjust the heat setting and the shelf as necessary, during cooking

During cooking, the cooling fan and the thermostat control light will operate in the same way as described for the fan oven function.

Hints and Tips

- Most foods should be placed on the grid in the grill pan to allow maximum circulation of air to lift the food out of the fats and juices. Food such as fish, liver and kidneys may be placed directly on the grill pan, if preferred
- Food should be thoroughly dried before grilling to minimise splashing. Brush lean meats and fish lightly with a little oil or melted butter to keep them moist during cooking
- Accompaniments such as tomatoes and mushrooms may be placed underneath the grid when grilling meats
- When toasting bread, we suggest that the top runner position is used with the grid in its 'high' position
- The food should be turned over during cooking, as required.

The grill element is controlled by the thermostat. During cooking, the grill cycles on and off to prevent overheating.

COOKING CHART

Cooking time depends on the thickness of the meat and not on its weight.

Type of food	Mins per side
Bacon rashers	2 - 5
Chicken joints	15 - 20
Gammon rashers	5 - 8
Lamb chops	6 - 12
Pork chops	10 - 15
Sausages (turning as required)	10 - 12
Steaks (average thickness)	Rare 3 - 6 Medium 6 - 10 Well done 8 - 12
Toast	1 - 1½

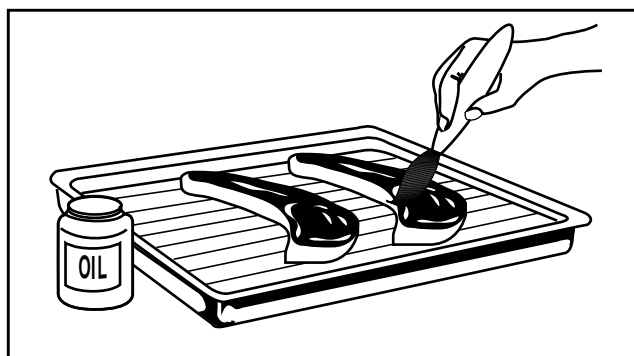

Cleaning the Oven



Before cleaning always allow the cooling fan to cool the oven down before switching off at the electricity supply.

The oven should be kept clean at all times. A build-up of fats or other foodstuffs could result in a fire, especially in the grill pan.

Cleaning materials

Before using any cleaning materials on your oven, check that they are suitable and that their use is recommended by the manufacturer.

Cleaners that contain bleach should NOT be used as they may dull the surface finishes. Harsh abrasives should also be avoided.

External cleaning

Regularly wipe over the control panel, oven door and door seal using a soft cloth well wrung out in warm water to which a little washing up liquid has been added.



To prevent damaging or weakening the door glass panels avoid the use of the following:

- Household detergent and bleaches
- Impregnated pads unsuitable for non-stick saucepans
- Brillo/Ajax pads or steel wool pads
- Chemical oven pads or aerosols
- Rust removers
- Bath/Sink stain removers

Clean the outer and inner door glass using warm soapy water. Should the inner door glass become heavily soiled it is recommended that a cleaning product such as Hob Brite, or Bar Keepers Friend is used.



DO NOT clean the oven door while the glass panels are warm. If this precaution is not observed the glass panel may shatter.

If the door glass panel becomes chipped or has deep scratches, the glass will be weakened and must be replaced to prevent the possibility of the panel shattering. Contact your local Service Centre who will be pleased to advise further.

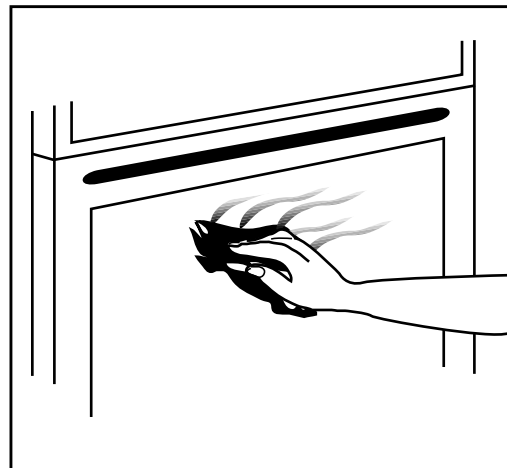

Oven Cavity

The enamelled oven cavity is best cleaned whilst the oven is still warm.

Wipe the oven over with a soft cloth soaked in warm soapy water after each use. From time to time it will be necessary to do a more thorough cleaning, using a proprietary oven cleaner.

If the soilage has become set, after the oven has cooled down, the following process will help to soften the splatters to help make cleaning easier.

1. Place the grill/ meat pan on the oven shelf positioned in the lowest runner.
2. Add a few drops of washing-up liquid to the pan and fill to about 12 mm. with boiling water from the kettle.
3. Close the oven door, turn the oven function knob on fan oven  and set the thermostat knob on 50°C.
4. After 15 minutes, turn off the thermostat and allow the fan oven to continue without heat for a further 5 minutes, when the temperature of the water will have cooled down.
5. Carefully remove the pan of water from the oven and use normal oven cleaners to clean away soil residues.
6. Leave a little of the soapy water to soak into any burned on spillage on the floor of the oven for a longer time if necessary.

Oven Shelves and Shelf Supports

To clean the oven shelves and the shelf supports, soak in warm soapy water and remove stubborn marks with a well wetted soap impregnated pad. Rinse well and dry with a soft cloth.

The shelf supports can be removed for easy cleaning (see diagram). Please, ensure the retaining nuts are secure when refitting the shelf support.

Grease Filter

To prevent a build-up of fats on the fan impellor, the grease filter must be fitted by clipping it over the vents in the back panel.

To clean the grease filter

When the oven has cooled down, remove the filter by pushing the protruding tongue on the filter upward, and wash carefully.

The grease filter should be cleaned after every use. The filter may be washed in a dishwasher on a 65°C wash. If the filter is heavily soiled, place the filter in a saucepan of water with approximately 1 teaspoon of automatic washing powder or dishwasher powder. Bring to the boil and leave to soak for approximately 30 minutes or longer depending on the degree of soiling. Ensure the solution does not boil over as it could mark your hob.

Rinse filter in clear water and dry.

Remember to refit the filter before using the oven again.

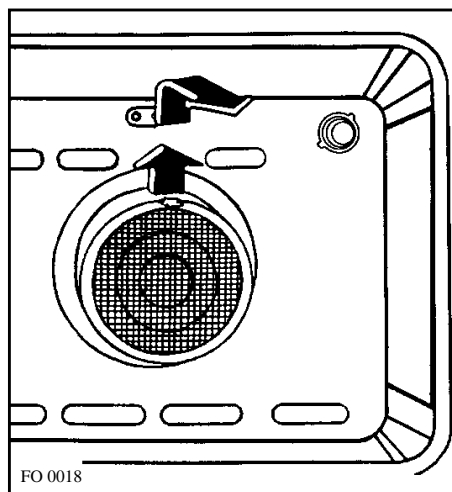
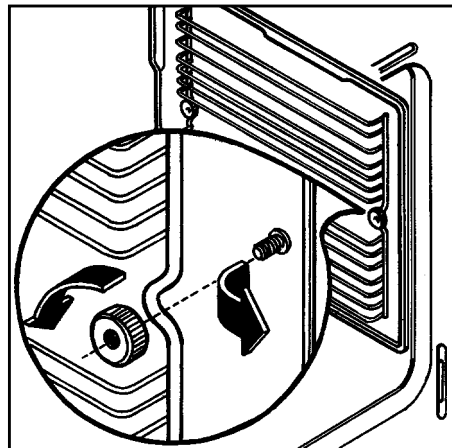

Catalytic liners (optional kit)

Catalytic panels can be fitted on the side walls of the main oven cavity to allow an easier cleaning. Please ask your local Service Force Centre for detailed information.

Catalytic liners destroy splashes of food and fats when the oven temperature is raised to around 220°C. To aid this process it is a good idea to run the oven for an hour or two per week, without food, to ensure continued good performance from the Catalytic liners.

Hints and Tips

- Manual cleaning of the Catalytic liner is not recommended. Damage will occur if soap impregnated steel wool pads, aerosol cleaners and any other abrasives are used.
- Slight discoloration and polishing of the Catalytic surface may occur in time. This does not affect the Catalytic properties in any way.
- Follow the recommendations below to keep oven soilage to a minimum.

COOKING TO REDUCE SOILAGE

Cook at the recommended temperatures. Higher temperatures during roasting will increase soilage. Try cooking to lower temperatures for an increased length of time, you will save energy and often the joint is more tender.

Use minimal, if any, extra oil or fat when roasting meat; potatoes only require brushing with fat before cooking. Extra fat in the oven during roasting will increase splashing and soilage.

It is NOT necessary to add water to the meat tin when roasting. The water and the fat juices from the joint create excessive splattering during cooking, even at normal temperatures, as well as causing condensation.

Covering joints during cooking will also prevent splashing onto the interior surfaces; removing the covering for the last 20-30 minutes will allow extra browning, if required. Some large joints and turkeys especially benefit by this method of cooking, allowing the joint to cook through before the outside is overbrowned.

Do use the roasting tin. During roasting, the fat from the joint will be contained beneath the trivet and therefore prevent it from splattering onto the 'Catalytic' liner.

Replacing the Oven Light

If the oven bulb needs replacing, it must comply with the following specifications:

- Electric power: 15W,
- Electric rate: 230-240 V (50 Hz),
- Resistant to temperatures of 300°C,
- Connection type: E14.

These bulbs are available from your local Zanussi Force Service Centre.



To replace the faulty bulb:

1. Ensure the oven is isolated from the electrical supply.
2. Turn the glass cover anticlockwise.
3. Remove the faulty bulb and replace with the new one.
4. Refit the glass cover.
5. Restore the electrical supply.

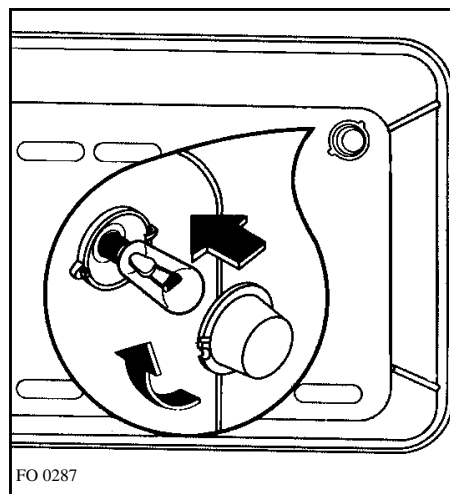

Cleaning the hinged grill (Lower Oven)

The lower oven has been fitted with a hinged grill element to enable you to clean the roof of the oven easily.

 ***Before proceeding ensure the oven is cool and is isolated from the electricity supply.***

 1) Undo the screw which holds the grill in place (see diagram beside).

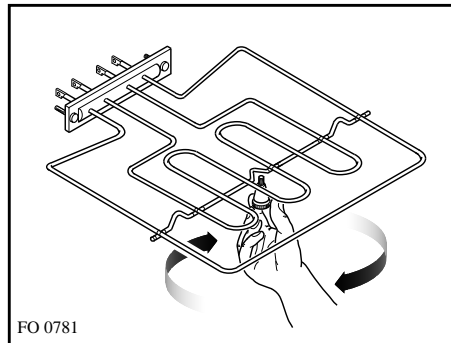

2) Then gently pull the grill downward to allow access to the oven roof (see diagram beside).

3) Clean the oven roof with a suitable cleaner and wipe dry before replacing the hinged grill element.

4) Gently push up the grill element into place and firmly screw into place the holding nut.

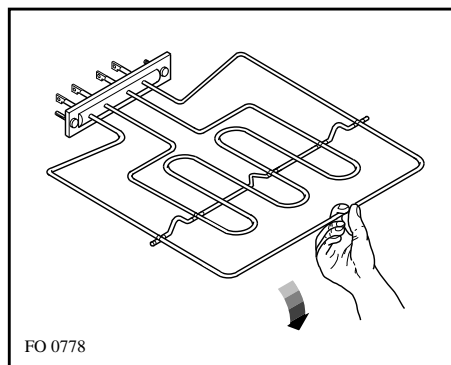

 ***Ensure the grill holding nut is firmly in place to avoid the grill falling down when in use.***

If something goes wrong

If the oven is not working correctly, please carry out the following checks, before contacting your local Zanussi Service Centre.

SYMPTOM	SOLUTION
<ul style="list-style-type: none"> ■ The oven does not come on 	<ul style="list-style-type: none"> ◆ Check the oven is in manual operation and that both a cooking function and temperature have been selected. ◆ Check the oven is wired in properly, and the socket switch or the switch from the mains supply to the oven are ON.
<ul style="list-style-type: none"> ■ The oven temperature light does not come on 	<ul style="list-style-type: none"> ◆ Select a temperature with the thermostat control knob ◆ Select a function with the oven function control knob.
<ul style="list-style-type: none"> ■ The oven light does not come on 	<ul style="list-style-type: none"> ◆ Select a function with the oven function control knob ◆ Check the light bulb, and replace it if necessary (see "Replacing the oven light")
<ul style="list-style-type: none"> ■ It takes too long to finish the dishes, or they are cooked too fast. 	<ul style="list-style-type: none"> ◆ The temperature may need adjusting ◆ Refer to the contents of this booklet, especially to the chapter "Using the Oven".
<ul style="list-style-type: none"> ■ Steam and condensation settle on the food and the oven cavity. 	<ul style="list-style-type: none"> ◆ Leave dishes inside the oven no longer than 15-20 minutes after the cooking is completed. See page 10
<ul style="list-style-type: none"> ■ The timer does not work 	<ul style="list-style-type: none"> ◆ Check the instructions for the timer.
<ul style="list-style-type: none"> ■ The oven fan is noisy 	<ul style="list-style-type: none"> ◆ Check the grease filter is correctly fitted. ◆ Check that shelves and bakeware are not vibrating in contact with the oven back panel.

If after all these checks, the oven still does not work, contact your local Zanussi Service Force Centre. When you contact them, they will need the following information:

1. Your name, address and post code.
2. Your telephone number
3. Clear and concise details of the fault
4. The model and the serial number (which can be found on the rating plate)
5. Date of purchase

Please note that it will be necessary to provide proof of purchase for any in-guarantee service calls.

In-guarantee customers should ensure that the above checks have been made as the engineer will make a charge if the fault is not a mechanical or electrical breakdown.

Service and Spare Parts



If you require spare parts or an engineer contact your local Service Force Centre by telephoning:

0990-929929

Your call will be routed to your local Service Force Centre. For further details, please see the accompanying Customer Care Booklet.

CUSTOMER CARE

For general enquiries concerning your Zanussi appliance, contact our Customer Care Department by letter or telephone as follows:

Customer Care Department

Zanussi House
Hambridge Road
Newbury, Berks, RG14 5EP
Tel: 01635 - 521313

Peace of Mind for 24 Months

ZANUSSI GUARANTEE CONDITIONS

We, Zanussi, undertake that if, within 24 months of the date of the purchase, this Zanussi appliance or any part thereof is proved to be defective by any reason only of faulty workmanship or materials, we will, at our option, repair or replace the same **FREE OF ANY CHARGE** for labour, materials or carriage on condition that:

- * The appliance has been correctly installed and used only on the gas and electricity supply stated on the rating plate.
- * The appliance has been used for normal domestic purpose only, and in accordance with the manufacturer's instructions.
- * The appliance has not been serviced, maintained, repaired, taken apart or tampered with by any person not authorised by us.
- * All service work under this guarantee must be undertaken by a Zanussi Service Centre.
- * Any appliance or defective part replaced shall become the Company's property.
- * This guarantee is in addition to your statutory and other legal rights.

Home visits are made between **8.30am and 5.30pm** Monday to Friday. Visits may be available outside these hours, in which case a **premium** will be charged.

Exclusions

This guarantee does not cover:

- * Damage or calls resulting from transportation, improper use or neglect, the replacement of any light bulbs or removable parts of glass or plastic.
- * Costs incurred for calls to put right an appliance which is improperly installed or calls to appliance outside the United Kingdom.

- * Appliances found to be in use within a commercial or similar environment, plus those which are the subject to rental agreements.
- * Products of Zanussi manufacture which are not marketed by Zanussi.

European Guarantee

If you should move to another country within Europe then your guarantee moves with you to your new home subject to the following qualifications:

- * The guarantee starts from the date you first purchased your product.
- * The guarantee is for the same period and to the same extent for labour and parts as exist in the new country of use for this brand or range of products.
- * This guarantee relates to you and cannot be transferred to another user.
- * Your new home is within the European Community (EC) or European Free Trade Area.
- * The product is installed and used in accordance with our instructions and is only used domestically, i.e. a normal household
- * The product is installed taking into account regulations in your new country.

Before you move, please contact your nearest Customer Care centre, listed below, to give them details of your new home. They will then ensure that the local Service Organisation is aware of your move and able to look after you and your appliances.

France	Senlis	+33 (0)3 44 62 29 99
Germany	Nürnberg	+49 (0)911 323 2600
Italy	Pordenone	+39 (0)1678 47053
Sweden	Stockholm	+46 (0)8 738 79 50
UK	Newbury	+44 (0)1635 521 313

Installation



The oven must be installed according to the instructions supplied.



This oven must be installed by **qualified personnel** to the relevant British Standards.

DIMENSIONS OF RECESS	Height	878 mm.
	Width	560-570 mm.
	Depth	550 mm.
DIMENSIONS OF THE MAIN OVEN CAVITY	Height	320 mm.
	Width	420 mm.
	Depth	390 mm.
	Oven capacity	53.2 litres
DIMENSIONS OF THE LOWER OVEN CAVITY	Height	185 mm.
	Width	420 mm.
	Depth	400 mm.
	Oven capacity	31 litres

Upper oven ratings

Convection element	2.08 kW
Convection Fan	30 W
Oven Light	15 W
Cooling Fan	25 W
Total Rating	2.150 kW

Lower oven ratings

Oven element	1.89 kW
Top element	0.834 kW
Grill element	1.82 kW
Oven Light	15 W
Total Rating	1.930 kW
Total connected load	4.055 kW

Electrical Connection

The oven is designed to be connected to 230-240V (50Hz) electricity supply.

The oven has an easily accessible terminal block which is marked as follows:

Letter L	-	Live terminal
Letter N	-	Neutral terminal
or E	-	Earth terminal

THIS OVEN MUST BE EARTHED

The cable used to connect the oven to the electrical supply must comply to the specifications given below.

For Uk use only

Connection via	Min. size Cable/flex	Cable / flex type	Fuse
• Cooker Control Circuit	6 mm ²	PVC/PVC twin and earth	30 A

For Europe use only

Min. size Cable/flex	Cable / flex type	Fuse
4 mm ²	H05 RR-F	30 A

It is necessary that you install a double pole switch between the oven and the electricity supply (mains), with a minimum gap of 3mm between the switch contacts and of a type suitable for the required load in compliance with the current rules.

The switch must not break the yellow and green earth cable at any point.

Important

After installation and connecting, the cable must be placed so that it cannot at any point reach a temperature of more than 60°C above the ambient temperature.

Before the oven is connected, check that the main fuse and the domestic installation can support the load; and that the power supply is properly earthed.

The manufacturer disclaims any responsibility should these safety measures not be carried out.

Building In



The oven must be installed according to the instructions supplied. Any electrical work must be undertaken by a qualified electrician/competent person, in accordance with existing rules and regulations.

It is dangerous to alter the specifications or modify the oven in any way.

Please ensure that when the oven is installed it is easily accessible for the engineer in the event of a breakdown.

BUILDING IN

The surround or cabinet into which the oven will be built must comply with these specifications:

- the dimensions must be as shown in the relevant diagrams;
- the materials must withstand a temperature increase of at least 60°C above ambient;
- proper arrangements must be made of a continuous supply of air to the oven to prevent the oven overheating.

Securing The Oven To The Cabinet

1. Fit the oven into the cabinet recess,
2. Open the oven door
3. Secure the oven to the kitchen cabinet with four wood screws, which fit the holes provided in the oven frame.

