



OWNER'S MANUAL

R O A D S T A R

*Warrior*

**XV1700PCR**  
**XV1700PCRC**

LIT-11626-16-36

5PX-28199-11

EAU03438

**⚠ WARNING**

**The engine exhaust from this product contains chemicals known to the State of California to cause cancer, birth defects or other reproductive harm.**

YAMAHA

LIT-CALIF-65-01

Congratulations on your purchase of the Yamaha XV1700PC/XV1700PCC. This model is the result of Yamaha's vast experience in the production of fine sporting, touring, and pacesetter racing machines. It represents the high degree of craftsmanship and reliability that have made Yamaha a leader in these fields.

This manual will give you an understanding of the operation, inspection, and basic maintenance of this motorcycle. If you have any questions concerning the operation or maintenance of your motorcycle, please consult a Yamaha dealer.

The design and manufacture of this Yamaha motorcycle fully comply with the emissions standards for clean air applicable at the date of manufacture. Yamaha has met these standards without reducing the performance or economy of operation of the motorcycle. To maintain these high standards, it is important that you and your Yamaha dealer pay close attention to the recommended maintenance schedules and operating instructions contained within this manual.

# IMPORTANT MANUAL INFORMATION

---

EAU00003

Particularly important information is distinguished in this manual by the following notations:



The Safety Alert Symbol means **ATTENTION! BECOME ALERT! YOUR SAFETY IS INVOLVED!**



Failure to follow **WARNING** instructions could result in severe injury or death to the motorcycle operator, a bystander or a person inspecting or repairing the motorcycle.

**CAUTION:**

A **CAUTION** indicates special precautions that must be taken to avoid damage to the motorcycle.

**NOTE:**

A **NOTE** provides key information to make procedures easier or clearer.

## **NOTE:** \_\_\_\_\_

- This manual should be considered a permanent part of this motorcycle and should remain with it even if the motorcycle is subsequently sold.
  - Yamaha continually seeks advancements in product design and quality. Therefore, while this manual contains the most current product information available at the time of printing, there may be minor discrepancies between your motorcycle and this manual. If you have any questions concerning this manual, please consult your Yamaha dealer.
-

# IMPORTANT MANUAL INFORMATION

---

EW000000

## **WARNING**

---

PLEASE READ THIS MANUAL AND THE “YOU AND YOUR MOTORCYCLE: RIDING TIPS” BOOKLET CAREFULLY AND COMPLETELY BEFORE OPERATING THIS MOTORCYCLE. DO NOT ATTEMPT TO OPERATE THIS MOTORCYCLE UNTIL YOU HAVE ATTAINED ADEQUATE KNOWLEDGE OF ITS CONTROLS AND OPERATING FEATURES AND UNTIL YOU HAVE BEEN TRAINED IN SAFE AND PROPER RIDING TECHNIQUES. REGULAR INSPECTIONS AND CAREFUL MAINTENANCE, ALONG WITH GOOD RIDING SKILLS, WILL ENSURE THAT YOU SAFELY ENJOY THE CAPABILITIES AND THE RELIABILITY OF THIS MOTORCYCLE.

---

# IMPORTANT MANUAL INFORMATION

---

AFFIX DEALER

LABEL HERE

EAU04247

**XV1700PCR/XV1700PCRC  
OWNER'S MANUAL  
©2002 by Yamaha Motor Corporation, U.S.A.  
1st edition, June 2002  
All rights reserved.  
Any reprinting or unauthorized use  
without the written permission of  
Yamaha Motor Corporation, U.S.A.  
is expressly prohibited.  
Printed in Japan.  
P/N LIT-11626-16-36**

1	SAFETY INFORMATION	1
2	DESCRIPTION	2
3	INSTRUMENT AND CONTROL FUNCTIONS	3
4	PRE-OPERATION CHECKS	4
5	OPERATION AND IMPORTANT RIDING POINTS	5
6	PERIODIC MAINTENANCE AND MINOR REPAIR	6
7	MOTORCYCLE CARE AND STORAGE	7
8	SPECIFICATIONS	8
9	CONSUMER INFORMATION	9
	INDEX	







Safe riding ..... 1-1  
Protective apparel ..... 1-3  
Modifications ..... 1-3  
Loading and accessories ..... 1-3  
Gasoline and exhaust gas..... 1-5  
Location of important labels ..... 1-7



MOTORCYCLES ARE SINGLE TRACK VEHICLES. THEIR SAFE USE AND OPERATION ARE DEPENDENT UPON THE USE OF PROPER RIDING TECHNIQUES AS WELL AS THE EXPERTISE OF THE OPERATOR. EVERY OPERATOR SHOULD KNOW THE FOLLOWING REQUIREMENTS BEFORE RIDING THIS MOTORCYCLE.

HE OR SHE SHOULD:

1. OBTAIN THOROUGH INSTRUCTIONS FROM A COMPETENT SOURCE ON ALL ASPECTS OF MOTORCYCLE OPERATION.
2. OBSERVE THE WARNINGS AND MAINTENANCE REQUIREMENTS IN THE OWNER'S MANUAL.
3. OBTAIN QUALIFIED TRAINING IN SAFE AND PROPER RIDING TECHNIQUES.
4. OBTAIN PROFESSIONAL TECHNICAL SERVICE AS INDICATED BY THE OWNER'S MANUAL AND/OR WHEN MADE NECESSARY BY MECHANICAL CONDITIONS.

## Safe riding

1. Always make pre-operation checks. Careful checks may help prevent an accident.
2. This motorcycle is designed to carry the operator and a passenger.
3. The failure of motorists to detect and recognize motorcycles in traffic is the predominating cause of automobile/motorcycle accidents. Many accidents have been caused by an automobile driver who did not see the motorcycle. Making yourself conspicuous appears to be very effective in reducing the chance of this type of accident.

Therefore:

- a. Wear a brightly colored jacket.
- b. Use extra caution when you are approaching and passing through intersections, since intersections are the most likely places for motorcycle accidents to occur.
- c. Ride where other motorists can see you. Avoid riding in another motorist's blind spot.

4. Many accidents involve inexperienced operators. In fact, many operators who have been involved in accidents do not even have a current motorcycle license.
  - a. Make sure that you are qualified and that you only lend your motorcycle to other qualified operators.
  - b. Know your skills and limits. Staying within your limits may help you to avoid an accident.
  - c. We recommend that you practice riding your motorcycle where there is no traffic until you have become thoroughly familiar with the motorcycle and all of its controls.
5. Many accidents have been caused by error of the motorcycle operator. A typical error made by the operator is veering wide on a turn due to EXCESSIVE SPEED or undercornering (insufficient lean angle for the speed).
  - a. Always obey the speed limit and never travel faster than warranted by road and traffic conditions.
  - b. Always signal before turning or changing lanes. Make sure that other motorists can see you.
6. The posture of the operator and passenger is important for proper control.
  - a. The operator should keep both hands on the handlebar and both feet on the operator footrests during operation to maintain control of the motorcycle.
  - b. The passenger should always hold onto the operator, the seat strap or grab bar, if equipped, with both hands and keep both feet on the passenger footrests.
  - c. Never carry a passenger unless he or she can firmly place both feet on the passenger footrests.
7. Never ride under the influence of alcohol or other drugs.
8. This motorcycle is designed for on-road use only. It is not suitable for off-road use.



# SAFETY INFORMATION

---

## Protective apparel

The majority of fatalities from motorcycle accidents are the result of head injuries. The use of a safety helmet is the single most critical factor in the prevention or reduction of head injuries.

1. Always wear an approved helmet.
2. Wear a face shield or goggles. Wind in your unprotected eyes could contribute to an impairment of vision that could delay seeing a hazard.
3. The use of a jacket, heavy boots, trousers, gloves, etc., is effective in preventing or reducing abrasions or lacerations.
4. Never wear loose-fitting clothes, otherwise they could catch on the control levers, footrests, or wheels and cause injury or an accident.
5. Never touch the engine or exhaust system during or after operation. They become very hot and can cause burns. Always wear protective clothing that covers your legs, ankles, and feet.
6. A passenger should also observe the above precautions.

## Modifications

Modifications made to this motorcycle not approved by Yamaha, or the removal of original equipment, may render the motorcycle unsafe for use and may cause severe personal injury. Modifications may also make your motorcycle illegal to use.

## Loading and accessories

Adding accessories or cargo to your motorcycle can adversely affect stability and handling if the weight distribution of the motorcycle is changed. To avoid the possibility of an accident, use extreme caution when adding cargo or accessories to your motorcycle. Use extra care when riding a motorcycle that has added cargo or accessories. Here are some general guidelines to follow if loading cargo or adding accessories to your motorcycle:

## Loading

The total weight of the operator, passenger, accessories and cargo must not exceed the maximum load limit of 408 lb (185 kg). When loading within this weight limit, keep the following in mind:

1. Cargo and accessory weight should be kept as low and close to the motorcycle as possible. Make sure to distribute the weight as evenly as possible on both sides of the motorcycle to minimize imbalance or instability.
2. Shifting weights can create a sudden imbalance. Make sure that accessories and cargo are securely attached to the motorcycle before riding. Check accessory mounts and cargo restraints frequently.
3. Never attach any large or heavy items to the handlebar, front fork, or front fender. These items, including such cargo as sleeping bags, duffel bags, or tents, can create unstable handling or a slow steering response.

## Accessories

Genuine Yamaha accessories have been specifically designed for use on this motorcycle. Since Yamaha cannot test all other accessories that may be available, you must personally be responsible for the proper selection, installation and use of non-Yamaha accessories. Use extreme caution when selecting and installing any accessories.

Keep the following guidelines in mind, as well as those provided under “Loading” when mounting accessories.

1. Never install accessories or carry cargo that would impair the performance of your motorcycle. Carefully inspect the accessory before using it to make sure that it does not in any way reduce ground clearance or cornering clearance, limit suspension travel, steering travel or control operation, or obscure lights or reflectors.

# SAFETY INFORMATION

---

- a. Accessories fitted to the handlebar or the front fork area can create instability due to improper weight distribution or aerodynamic changes. If accessories are added to the handlebar or front fork area, they must be as lightweight as possible and should be kept to a minimum.
  - b. Bulky or large accessories may seriously affect the stability of the motorcycle due to aerodynamic effects. Wind may attempt to lift the motorcycle, or the motorcycle may become unstable in cross winds. These accessories may also cause instability when passing or being passed by large vehicles.
  - c. Certain accessories can displace the operator from his or her normal riding position. This improper position limits the freedom of movement of the operator and may limit control ability, therefore, such accessories are not recommended.
2. Use caution when adding electrical accessories. If electrical accessories exceed the capacity of the motorcycle's electrical system, an electric failure could result, which could cause a dangerous loss of lights or engine power.

## **Gasoline and exhaust gas**

1. GASOLINE IS HIGHLY FLAMMABLE:
  - a. Always turn the engine off when refueling.
  - b. Take care not to spill any gasoline on the engine or exhaust system when refueling.
  - c. Never refuel while smoking or in the vicinity of an open flame.
2. Never start the engine or let it run for any length of time in a closed area. The exhaust fumes are poisonous and may cause loss of consciousness and death within a short time. Always operate your motorcycle in an area that has adequate ventilation.
3. Always turn the engine off before leaving the motorcycle unattended and remove the key from the main switch. When parking the motorcycle, note the following:

- a. The engine and exhaust system may be hot, therefore, park the motorcycle in a place where pedestrians or children are not likely to touch these hot areas.
  - b. Do not park the motorcycle on a slope or soft ground, otherwise it may fall over.
  - c. Do not park the motorcycle near a flammable source (e.g., a kerosene heater, or near an open flame), otherwise it could catch fire.
4. When transporting the motorcycle in another vehicle, make sure that it is kept upright. If the motorcycle should lean over, gasoline may leak out of the fuel tank.
  5. If you should swallow any gasoline, inhale a lot of gasoline vapor, or allow gasoline to get into your eyes, see your doctor immediately. If any gasoline spills on your skin or clothing, immediately wash the affected area with soap and water and change your clothes.

# SAFETY INFORMATION

EAU02977

## Location of important labels

Please read the following important labels carefully before operating this motorcycle.

1

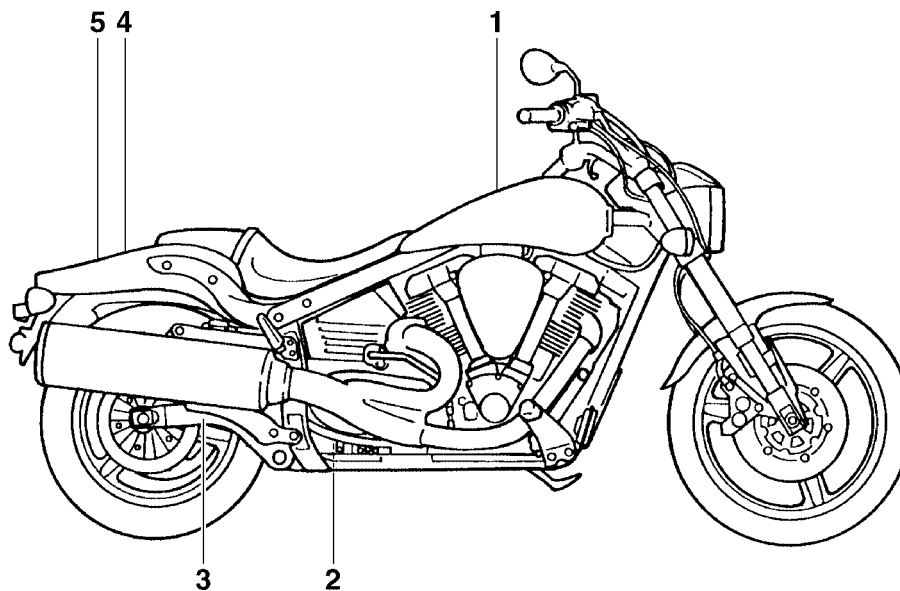



**1**

**⚠ WARNING**

- **BEFORE YOU OPERATE THIS VEHICLE, READ THE OWNER'S MANUAL AND ALL LABELS.**
- **ALWAYS WEAR AN APPROVED MOTORCYCLE HELMET, eye protection, and protective clothing.**

5GK-2118K-00

**2**

**⚠ WARNING**

This unit contains high pressure nitrogen gas. Mishandling can cause explosion.

- Read owner's manual for instructions.
- Do not incinerate, puncture or open.

4AA-22259-80

1

**3**

**TIRE INFORMATION**

Cold tire normal pressure should be set as follows.

- Up to 90 kg (198 lbs) load

**FRONT** : 250 kPa, {2.50 kgf/cm<sup>2</sup>}, 36psi

**REAR** : 250 kPa, {2.50 kgf/cm<sup>2</sup>}, 36psi- 90 kg (198 lbs) ~ maximum load

**FRONT** : 250 kPa, {2.50 kgf/cm<sup>2</sup>}, 36psi

**REAR** : 290 kPa, {2.90 kgf/cm<sup>2</sup>}, 42psi

5JW-2166B-00

**California only**

**4**

**VACUUM HOSE ROUTING**

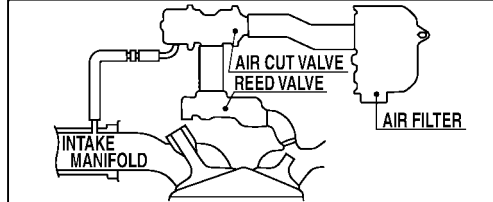

INTAKE MANIFOLD

AIR CUT VALVE REED VALVE

AIR FILTER

4YN-21684-00

**California only**

**5**

**EMISSION HOSE ROUTING**

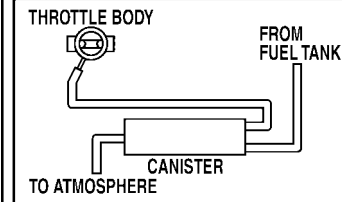

THROTTLE BODY

FROM FUEL TANK

CANISTER

TO ATMOSPHERE

5PX-21686-00



Left view .....	2-1
Right view.....	2-2
Controls and instruments .....	2-3

## Left view

2

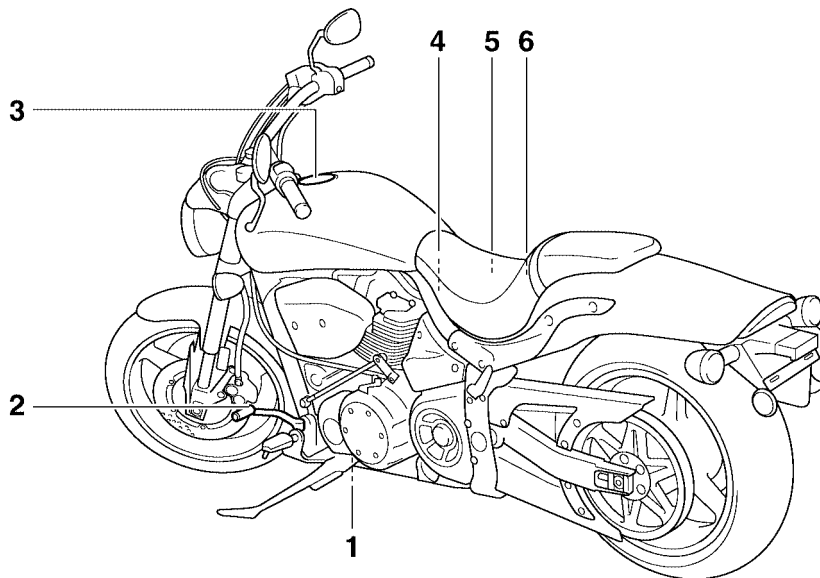

- 1. Engine oil drain bolt (crankcase)
- 2. Shift pedal
- 3. Fuel tank cap

(page 6-11)  
(page 3-7)  
(page 3-9)

- 4. Helmet holder
- 5. Fuses
- 6. Owner's tool kit

(page 3-11)  
(page 6-37)  
(page 6-2)

## Right view

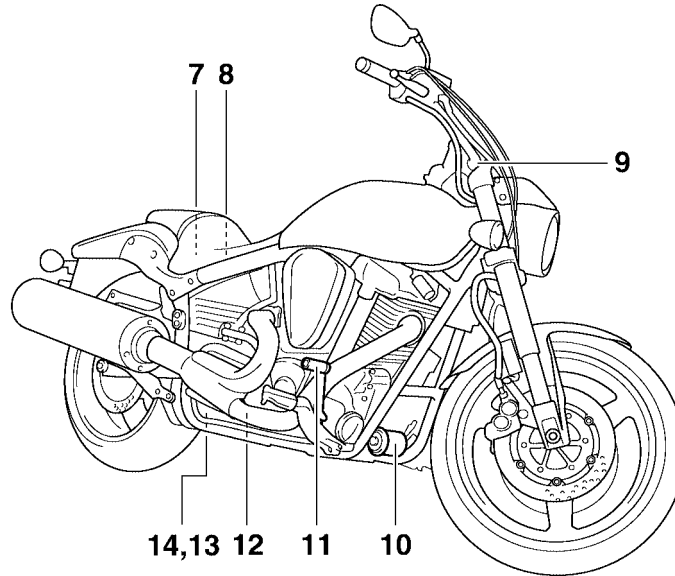

- |   |             |  |             |
|---|-------------|--|-------------|
| 7. Battery                                  | (page 6-35) | 11. Brake pedal  | (page 3-8)  |
| 8. Engine oil filler cap                    | (page 6-9)  | 12. Engine oil drain bolt (oil tank)                             | (page 6-10) |
| 9. Front fork spring preload adjusting bolt | (page 3-12) | 13. Shock absorber assembly spring preload adjusting nut         | (page 3-13) |
| 10. Engine oil filter cartridge             | (page 6-11) | 14. Shock absorber assembly rebound damping force adjusting knob | (page 3-14) |

# DESCRIPTION

---

## Controls and instruments

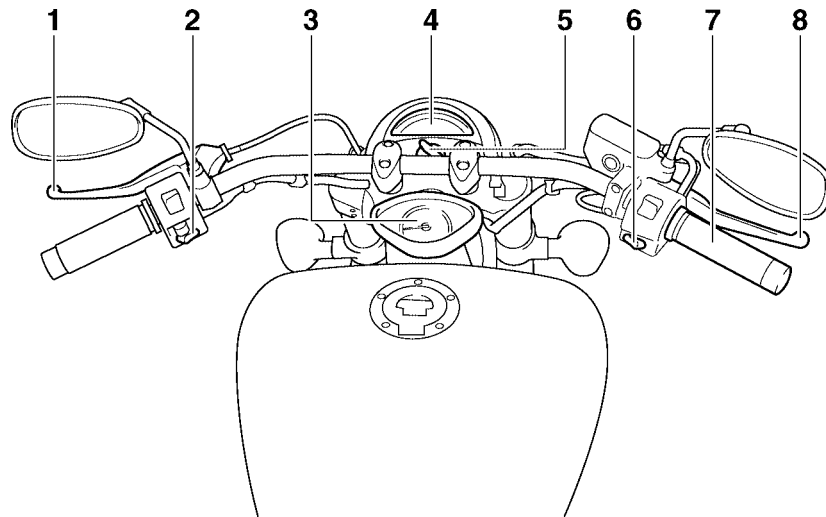

- 1. Clutch lever
- 2. Left handlebar switches
- 3. Speedometer
- 4. Tachometer unit
- 5. Main switch/steering lock

(page 3-7)  
(page 3-6)  
(page 3-3)  
(page 3-4)  
(page 3-1)

- 6. Right handlebar switches
- 7. Throttle grip
- 8. Brake lever

(page 3-7)  
(page 6-18)  
(page 3-8)

# INSTRUMENT AND CONTROL FUNCTIONS

Main switch/steering lock .....	3-1
Indicator and warning lights .....	3-2
Speedometer .....	3-3
Tachometer unit .....	3-4
Handlebar switches .....	3-6
Clutch lever .....	3-7
Shift pedal .....	3-7
Brake lever .....	3-8
Brake pedal .....	3-8
Fuel tank cap .....	3-9
Fuel .....	3-9
Seat .....	3-11
Helmet holder .....	3-11
Adjusting the front fork .....	3-12
Adjusting the shock absorber assembly .....	3-13
Sidestand .....	3-15
Ignition circuit cut-off system .....	3-16

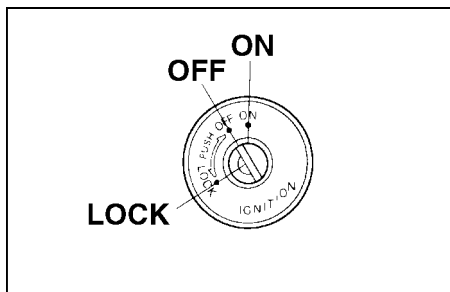

EAU00029

## Main switch/steering lock

The main switch/steering lock controls the ignition and lighting systems, and is used to lock the steering. The various positions are described below.

### ON

EAU04437

All electrical circuits are supplied with power, and the meter lighting, taillight, license plate light and position lights come on, and the engine can be started. The key cannot be removed.

### NOTE:

The headlight comes on automatically when the engine is started and stays on until the key is turned to "OFF", even if the engine stalls.

EAU00038

### OFF

All electrical systems are off. The key can be removed.

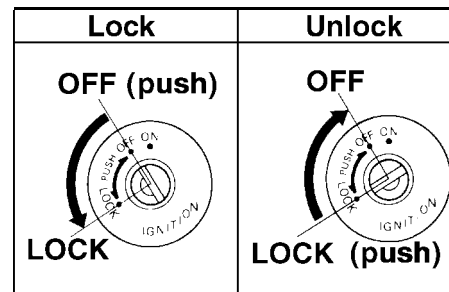

EAU00040

### LOCK

The steering is locked, and all electrical systems are off. The key can be removed.

#### To lock the steering

1. Turn the handlebars all the way to the left.
2. Push the key in from the "OFF" position, and then turn it to "LOCK" while still pushing it.
3. Remove the key.

#### To unlock the steering

Push the key in, and then turn it to "OFF" while still pushing it.



# INSTRUMENT AND CONTROL FUNCTIONS

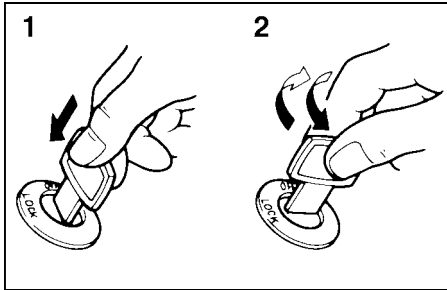





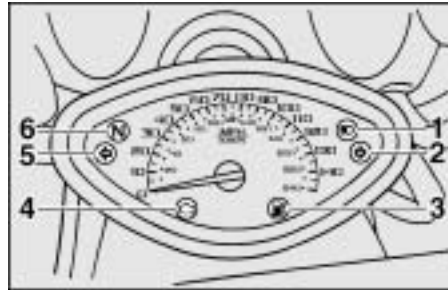

1. Push.
2. Turn.

EW000016

## **⚠ WARNING**

**Never turn the key to “OFF” or “LOCK” while the motorcycle is moving, otherwise the electrical systems will be switched off, which may result in loss of control or an accident. Make sure that the motorcycle is stopped before turning the key to “OFF” or “LOCK”.**



1. High beam indicator light “”
2. Right turn signal indicator light “”
3. Fuel level warning light “”
4. Engine trouble warning light “”
5. Left turn signal indicator light “”
6. Neutral indicator light “N”

EAU03034

## Indicator and warning lights

EAU00063

### High beam indicator light “”

This indicator light comes on when the high beam of the headlight is switched on.

EAU04121

### Turn signal indicator lights “” and “”

The corresponding indicator light flashes when the turn signal switch is pushed to the left or right.

EAU04878





### Fuel level warning light “”

This warning light comes on when the fuel level drops below approximately 0.8 US gal (0.7 Imp gal, 3.0 L). When this occurs, refuel as soon as possible. The electrical circuit of the warning light can be checked by turning the key to “ON”.

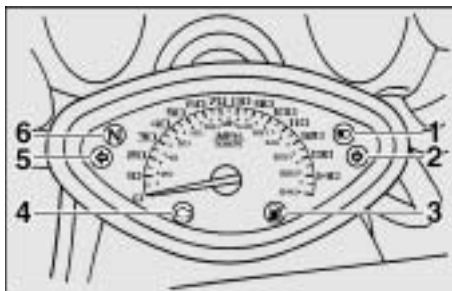
If the warning light does not come on for a few seconds, then go off, have a Yamaha dealer check the electrical circuit.

# INSTRUMENT AND CONTROL FUNCTIONS



1. High beam indicator light “”
2. Right turn signal indicator light “”
3. Fuel level warning light “”
4. Engine trouble warning light “”
5. Left turn signal indicator light “”
6. Neutral indicator light “**N**”

EAU04867

## Engine trouble warning light “”

This warning light comes on when an electrical circuit monitoring the engine is defective. When this occurs, have a Yamaha dealer check the self-diagnosis system.

The electrical circuit of the warning light can be checked by turning the key to “ON”. If the warning light does not come on for a few seconds, then go off, have a Yamaha dealer check the electrical circuit.

EAU00061

## Neutral indicator light “**N**”

This indicator light comes on when the transmission is in the neutral position.

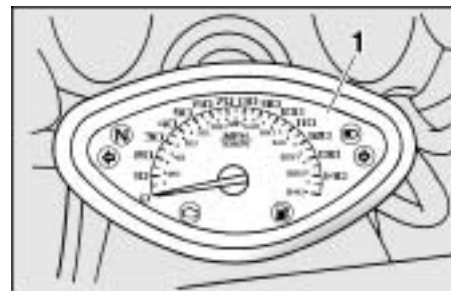

1. Speedometer

EAU04031

## Speedometer

The speedometer shows the riding speed.

# INSTRUMENT AND CONTROL FUNCTIONS



1. Tachometer
2. Clock
3. Odometer/tripmeter/fuel reserve tripmeter
4. "RESET" button
5. "SELECT" button

EAU04436

## Tachometer unit

The electric tachometer allows the rider to monitor the engine speed and keep it within the ideal power range.

The tachometer unit is equipped with the following:

- an odometer (which shows the total distance traveled)
- two tripmeters (which show the distance traveled since they were last set to zero)

- a fuel reserve tripmeter (which shows the distance traveled since the fuel level warning light came on)
- a meter lighting control
- a clock
- a self diagnosis device

**NOTE:** \_\_\_\_\_

- Be sure to turn the key to "ON" before using the "SELECT" and "RESET" buttons.
- To switch the odometer, the tripmeters and the fuel reserve tripmeter displays between kilometers and miles, press the "SELECT" button for at least two seconds.

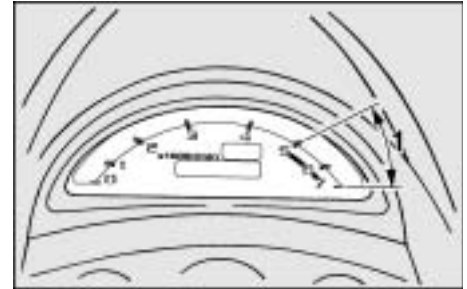

1. Tachometer red zone

ECA00123

## CAUTION:

**Do not operate the engine in the tachometer red zone. If operated in the red zone, the tachometer segments will start flashing to notify the rider.**

**Red zone: 5,000 r/min and above**

# INSTRUMENT AND CONTROL FUNCTIONS

---

## Odometer and tripmeter modes

Pushing the “SELECT” button switches the display between the odometer mode “ODO” and the tripmeter modes “TRIP 1” and “TRIP 2” in the following order:

ODO → TRIP 1 → TRIP 2 → ODO

If the fuel level warning light comes on (see page 3-2), the odometer display will automatically change to the fuel reserve tripmeter mode “TRIP F” and start counting the distance traveled from that point. In that case, pushing the “SELECT” button switches the display between the various tripmeter and odometer modes in the following order: TRIP F → TRIP 1 → TRIP 2 → ODO → TRIP F

To reset a tripmeter, select it by pushing the “SELECT” button, and then push the “RESET” button for at least one second. If you do not reset the fuel reserve tripmeter manually, it will reset itself automatically and the display will return to the prior mode after refueling and traveling 3 mi (5 km).

## Meter lighting control mode

1. Turn the key to “OFF”.
2. Push and hold the “SELECT” button.
3. Turn the key to “ON”, and then after five seconds, release the “SELECT” button.
4. Push the “RESET” button to select the desired brightness.
5. Push the “SELECT” button to set the brightness level.
6. Turn the key to “OFF”.

### NOTE: \_\_\_\_\_

When adjusting the meter lighting, the odometer display will indicate the brightness level.

---

## Clock mode

To set the clock:

1. Push the “SELECT” button and “RESET” button together for at least two seconds.
2. When the hour digits start flashing, push the “RESET” button to set the hours.
3. Push the “SELECT” button, and the minute digits will start flashing.
4. Push the “RESET” button to set the minutes.
5. Push the “SELECT” button and then release it to start the clock.

### NOTE: \_\_\_\_\_

- After setting the clock, be sure to push the “SELECT” button before turning the key to “OFF”, otherwise the clock will not be set.
  - To set the clock after the battery has been disconnected, first set the time to 1:00 AM, and then set the clock to the correct time.
-

# INSTRUMENT AND CONTROL FUNCTIONS

## Self diagnosis device

This model is equipped with a self-diagnosis device for various electrical circuits.

If any of those circuits are defective, the clock display will indicate a two-digit error code (e.g., 11, 12, 13).

If the clock display indicates such an error code, note the code number, and then have a Yamaha dealer check the motorcycle.

ECA00122

### CAUTION:

**If the clock display indicates an error code, the motorcycle should be checked as soon as possible in order to avoid engine damage.**

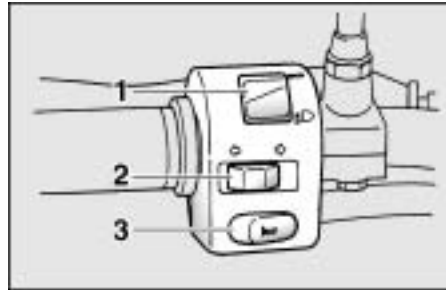

1. Dimmer switch “☀/☁”
2. Turn signal switch “←/→”
3. Horn switch “🔔”

## Handlebar switches

EAU00118

### Dimmer switch “☀/☁”

EAU03888

Set this switch to “☀” for the high beam and to “☁” for the low beam.

### Turn signal switch “←/→”

EAU04218

To signal a right-hand turn, push this switch to “→”. To signal a left-hand turn, push this switch to “←”. When released, the switch returns to the center position.

Since this model is equipped with a self-canceling system, the turn signal lights will self-cancel after the motorcycle has traveled both about 490 ft (150 m) and for approximately 15 seconds. However, the turn signal lights can also be canceled manually by pushing the switch in after it has returned to the center position.

### NOTE:

The self-canceling system only operates when the motorcycle is moving, so that the turn signal lights will not self-cancel while you are stopped at an intersection.

### Horn switch “🔔”

EAU00129

Press this switch to sound the horn.

# INSTRUMENT AND CONTROL FUNCTIONS

3

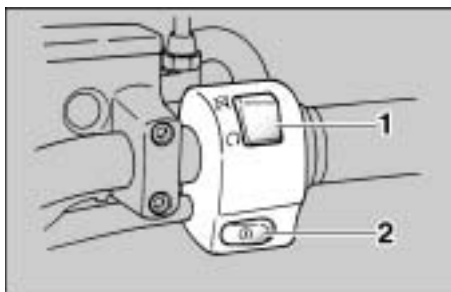

1. Engine stop switch “○/⊗”
2. Start switch “⊗”

EAU03890

## Engine stop switch “○/⊗”

Set this switch to “○” before starting the engine. Set this switch to “⊗” to stop the engine in case of an emergency, such as when the motorcycle over-turns or when the throttle cable is stuck.

EAU00143

## Start switch “⊗”

Push this switch to crank the engine with the starter.

EC000005

### CAUTION:

**See page 5-1 for starting instructions prior to starting the engine.**

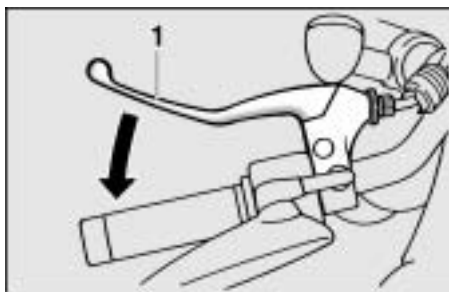

1. Clutch lever

EAU00152

## Clutch lever

The clutch lever is located at the left handlebar grip. To disengage the clutch, pull the lever toward the handlebar grip. To engage the clutch, release the lever. The lever should be pulled rapidly and released slowly for smooth clutch operation.

The clutch lever is equipped with a clutch switch, which is part of the ignition circuit cut-off system. (See page 3-16 for an explanation of the ignition circuit cut-off system.)

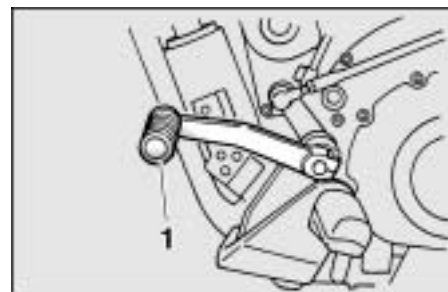

1. Shift pedal

EAU00157

## Shift pedal

The shift pedal is located on the left side of the engine and is used in combination with the clutch lever when shifting the gears of the 5-speed constant-mesh transmission equipped on this motorcycle.

# INSTRUMENT AND CONTROL FUNCTIONS

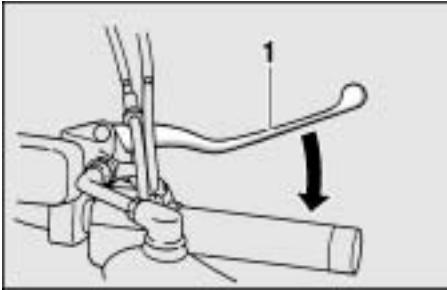

1. Brake lever

EAU00158

## Brake lever

The brake lever is located at the right handlebar grip. To apply the front brake, pull the lever toward the handlebar grip.

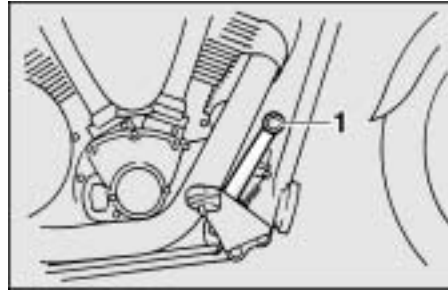

1. Brake pedal

EAU00162

## Brake pedal

The brake pedal is on the right side of the motorcycle. To apply the rear brake, press down on the brake pedal.

# INSTRUMENT AND CONTROL FUNCTIONS

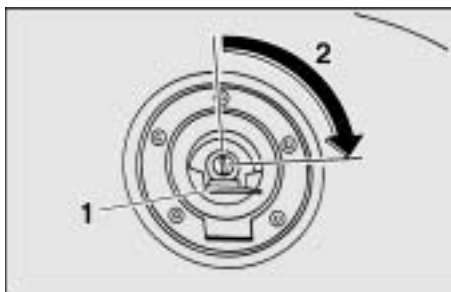

1. Fuel tank cap lock cover
2. Unlock.

EAU02935

## Fuel tank cap

### To open the fuel tank cap

Open the fuel tank cap lock cover, insert the key into the lock, and then turn it 1/4 turn clockwise. The lock will be released and the fuel tank cap can be opened.

### To close the fuel tank cap

1. Push the fuel tank cap into position with the key inserted in the lock.
2. Turn the key counterclockwise to the original position, remove it, and then close the lock cover.

### NOTE:

The fuel tank cannot be closed unless the key is in the lock. In addition, the key cannot be removed if the cap is not properly closed and locked.

EWA00025



**WARNING**  
Make sure that the fuel tank cap is properly closed before riding.

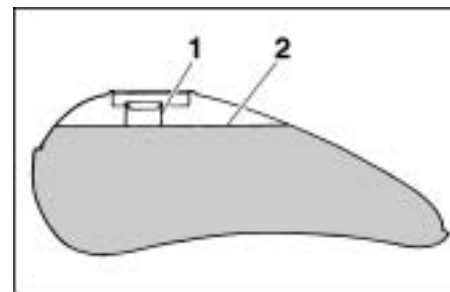

1. Fuel tank filler tube
2. Fuel level

EAU03753

## Fuel

Make sure that there is sufficient fuel in the tank. Fill the fuel tank to the bottom of the filler tube as shown.

EW000130



- WARNING**
- Do not overfill the fuel tank, otherwise it may overflow when the fuel warms up and expands.
  - Avoid spilling fuel on the hot engine.



EAU00185

**CAUTION:**

**Immediately wipe off spilled fuel with a clean, dry, soft cloth, since fuel may deteriorate painted surfaces or plastic parts.**

EAU04438

Recommended fuel:

**UNLEADED GASOLINE ONLY**

Fuel tank capacity:

Total amount:

4.0 US gal (3.3 Imp gal, 15.0 L)

Amount remaining when the fuel level warning light comes on:

0.8 US gal (0.7 Imp gal, 3.0 L)

ECA00104

**CAUTION:**

**Use only unleaded gasoline. The use of leaded gasoline will cause severe damage to internal engine parts, such as the valves and piston rings, as well as to the exhaust system.**

Your Yamaha engine has been designed to use regular unleaded gasoline with a pump octane number  $[(R+M)/2]$  of 86 or higher, or a research octane number of 91 or higher. If knocking (or pinging) occurs, use a gasoline of a different brand or premium unleaded fuel. Use of unleaded fuel will extend spark plug life and reduce maintenance costs.

### Gasohol

There are two types of gasohol: gasohol containing ethanol and that containing methanol. Gasohol containing ethanol can be used if the ethanol content does not exceed 10%. Gasohol containing methanol is not recommended by Yamaha because it can cause damage to the fuel system or vehicle performance problems.

# INSTRUMENT AND CONTROL FUNCTIONS

3

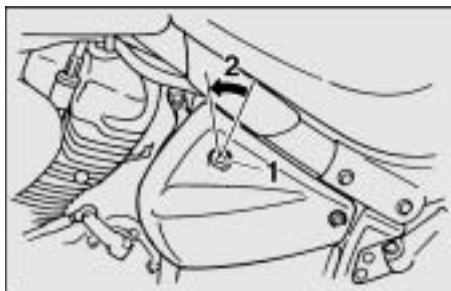

1. Seat lock
2. Unlock.

EAU01319

## Seat

### To remove the seat

1. Insert the key into the seat lock, and then turn it counterclockwise.
2. While holding the key in that position, lift the front of the seat up, and then pull the seat off.

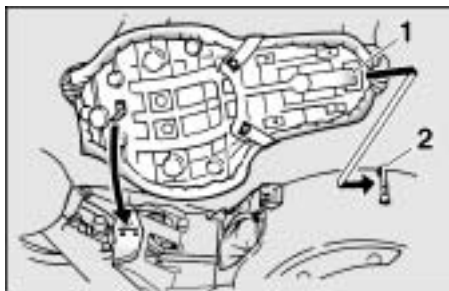

1. Projection
2. Seat holder

### To install the seat

1. Insert the projection on the rear of the seat into the seat holder as shown.
2. Push the front of the seat down to lock it in place.
3. Remove the key.

**NOTE:** \_\_\_\_\_  
Make sure that the seat is properly secured before riding.  
\_\_\_\_\_



1. Helmet holder

EAU00263\*

## Helmet holder

The helmet holder is located under the seat.

### To secure a helmet to the helmet holder

1. Remove the seat.
2. Attach the helmet to the helmet holder, and then securely install the seat.

# INSTRUMENT AND CONTROL FUNCTIONS

EW000030

## **⚠ WARNING**

Never ride with a helmet attached to the helmet holder, since the helmet may hit objects, causing loss of control and possibly an accident.

### To release the helmet from the helmet holder

Remove the seat, remove the helmet from the helmet holder, and then install the seat.

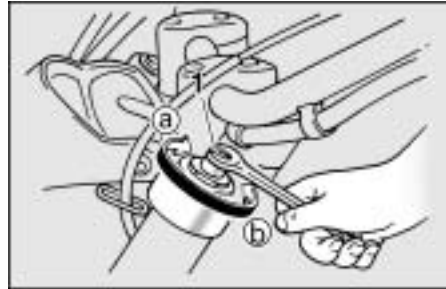

1. Spring preload adjusting bolt

EAU00265

### Adjusting the front fork

This front fork is equipped with spring preload adjusting bolts.

EW000035

## **⚠ WARNING**

Always adjust both fork legs equally, otherwise poor handling and loss of stability may result.

Adjust the spring preload as follows.

To increase the spring preload and thereby harden the suspension, turn the adjusting bolt on each fork leg in direction ①. To decrease the spring preload and thereby soften the suspension, turn the adjusting bolt on each fork leg in direction ②.

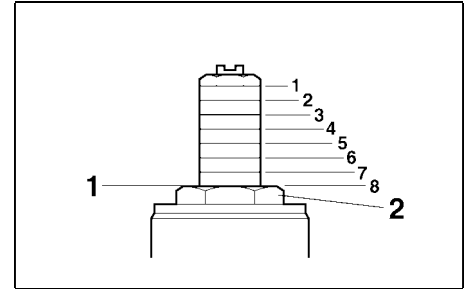

1. Current setting  
2. Front fork cap bolt

### NOTE:

Align the appropriate groove on the adjusting mechanism with the top of the front fork cap bolt.

	Setting
Minimum (soft)	8
Standard	5
Maximum (hard)	1

# INSTRUMENT AND CONTROL FUNCTIONS

3

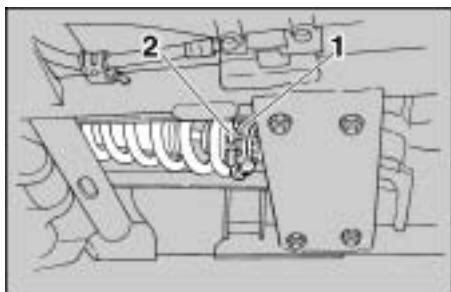

1. Locknut
2. Spring preload adjusting nut

EAU04873

## Adjusting the shock absorber assembly

This shock absorber assembly is equipped with a spring preload adjusting nut and a rebound damping force adjusting knob.

EC000015

### CAUTION:

Never attempt to turn an adjusting mechanism beyond the maximum or minimum settings.

### Spring preload

1. Loosen the locknut.

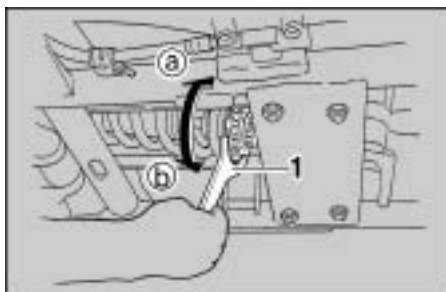

1. Special wrench
2. To increase the spring preload and thereby harden the suspension, turn the adjusting nut in direction (a). To decrease the spring preload and thereby soften the suspension, turn the adjusting nut in direction (b).

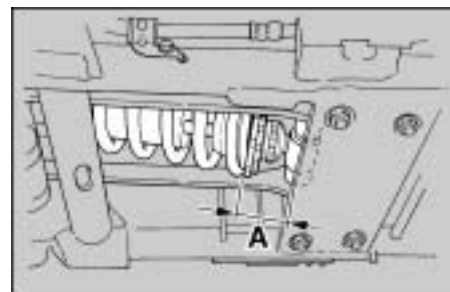

A. Distance A

### NOTE:

- Use the special wrench included in the owner's tool kit to make the adjustment.
- The spring preload setting is determined by measuring distance A, shown in the illustration. The longer distance A is, the higher the spring preload; the shorter distance A is, the lower the spring preload. With each complete turn of the adjusting nut, distance A is changed by 1.0 mm (0.04 in).

# INSTRUMENT AND CONTROL FUNCTIONS

Spring preload:

Minimum (soft):

Distance A = 2.05 in (52 mm)

Standard:

Distance A = 2.13 in (54 mm)

Maximum (hard):

Distance A = 2.48 in (63 mm)

3. Tighten the locknut to the specified torque.

Tightening torque:

Locknut:

36 ft·lbf (5.0 m·kgf, 50 Nm)

ECA00076

## CAUTION:

**Always tighten the locknut against the adjusting nut, and then tighten the locknut to the specified torque.**

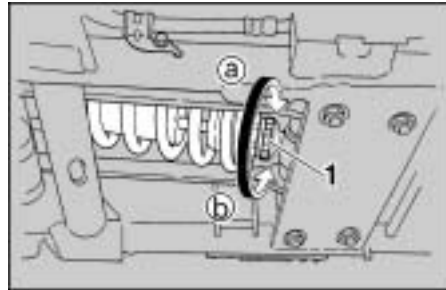

1. Rebound damping force adjusting knob

## Rebound damping force

To increase the rebound damping force and thereby harden the rebound damping, turn the adjusting knob in direction ①. To decrease the rebound damping force and thereby soften the rebound damping, turn the adjusting knob in direction ②.

Minimum (soft)	20 clicks in direction ②*
Standard	10 clicks in direction ②*
Maximum (hard)	3 clicks in direction ②*

\* With the adjusting knob fully turned in direction ①

## NOTE:

Although the total number of clicks of the damping force adjusting mechanism may not exactly match the above specifications due to small differences in production, the actual number of clicks always represents the entire adjusting range. To obtain a precise adjustment, it would be advisable to check the number of clicks of the damping force adjusting mechanism and to modify the specifications as necessary.

**⚠ WARNING**

This shock absorber contains highly pressurized nitrogen gas. For proper handling, read and understand the following information before handling the shock absorber. The manufacturer cannot be held responsible for property damage or personal injury that may result from improper handling.

- Do not tamper with or attempt to open the gas cylinder.
- Do not subject the shock absorber to an open flame or other high heat sources, otherwise it may explode due to excessive gas pressure.
- Do not deform or damage the gas cylinder in any way, as this will result in poor damping performance.
- Always have a Yamaha dealer service the shock absorber.

## Sidestand

The sidestand is located on the left side of the frame. Raise the sidestand or lower it with your foot while holding the motorcycle upright.

**NOTE:**

The built-in sidestand switch is part of the ignition circuit cut-off system, which cuts the ignition in certain situations. (See further down for an explanation of the ignition circuit cut-off system.)

**⚠ WARNING**

The motorcycle must not be ridden with the sidestand down, or if the sidestand cannot be properly moved up (or does not stay up), otherwise the sidestand could contact the ground and distract the operator, resulting in a possible loss of control. Yamaha's ignition circuit cut-off system has been designed to assist the operator in fulfilling the responsibility of raising the sidestand before starting off. Therefore, check this system regularly as described below and have a Yamaha dealer repair it if it does not function properly.

EAU03720

## Ignition circuit cut-off system

The ignition circuit cut-off system (comprising the sidestand switch, clutch switch and neutral switch) has the following functions.

- It prevents starting when the transmission is in gear and the sidestand is up, but the clutch lever is not pulled.
- It prevents starting when the transmission is in gear and the clutch lever is pulled, but the sidestand is still down.
- It cuts the running engine when the transmission is in gear and the sidestand is moved down.

Periodically check the operation of the ignition circuit cut-off system according to the following procedure.

EW000045



**If a malfunction is noted, have a Yamaha dealer check the system before riding.**

# INSTRUMENT AND CONTROL FUNCTIONS

3

With the engine turned off:  
1. Move the sidestand down.  
2. Make sure that the engine stop switch is set to "O".  
3. Turn the key to "ON".  
4. Shift the transmission into the neutral position.  
5. Push the start switch.  
**Does the engine start?**

YES

NO

**NOTE:** \_\_\_\_\_  
This check is most reliable if performed with  
a warmed-up engine.  
\_\_\_\_\_

The neutral switch may be defective.  
**The motorcycle should not be ridden** until  
checked by a Yamaha dealer.

With the engine still running:  
6. Move the sidestand up.  
7. Keep the clutch lever pulled.  
8. Shift the transmission into gear.  
9. Move the sidestand down.  
**Does the engine stall?**

YES

NO

The sidestand switch may be defective.  
**The motorcycle should not be ridden** until  
checked by a Yamaha dealer.

After the engine has stalled:  
10. Move the sidestand up.  
11. Keep the clutch lever pulled.  
12. Push the start switch.  
**Does the engine start?**

YES

NO

The clutch switch may be defective.  
**The motorcycle should not be ridden** until  
checked by a Yamaha dealer.

The system is OK. **The motorcycle can be ridden.**



Pre-operation check list ..... 4-1

# PRE-OPERATION CHECKS

The condition of a vehicle is the owner's responsibility. Vital components can start to deteriorate quickly and unexpectedly, even if the vehicle remains unused (for example, as a result of exposure to the elements). Any damage, fluid leakage or loss of tire air pressure could have serious consequences. Therefore, it is very important, in addition to a thorough visual inspection, to check the following points before each ride.

## Pre-operation check list

ITEM	CHECKS	PAGE
<b>Fuel</b>	<ul style="list-style-type: none"><li>• Check fuel level in fuel tank.</li><li>• Refuel if necessary.</li><li>• Check fuel line for leakage.</li></ul>	3-9-3-10
<b>Engine oil</b>	<ul style="list-style-type: none"><li>• Check oil level in engine.</li><li>• If necessary, add recommended oil to specified level.</li><li>• Check vehicle for oil leakage.</li></ul>	6-9-6-10
<b>Front brake</b>	<ul style="list-style-type: none"><li>• Check operation.</li><li>• If soft or spongy, have Yamaha dealer bleed hydraulic system.</li><li>• Check lever free play.</li><li>• Adjust if necessary.</li><li>• Check fluid level in reservoir.</li><li>• If necessary, add recommended brake fluid to specified level.</li><li>• Check hydraulic system for leakage.</li></ul>	6-24, 6-26-6-28
<b>Rear brake</b>	<ul style="list-style-type: none"><li>• Check operation.</li><li>• If soft or spongy, have Yamaha dealer bleed hydraulic system.</li><li>• Check fluid level in reservoir.</li><li>• If necessary, add recommended brake fluid to specified level.</li><li>• Check hydraulic system for leakage.</li></ul>	6-25-6-28
<b>Clutch</b>	<ul style="list-style-type: none"><li>• Check operation.</li><li>• Lubricate cable if necessary.</li><li>• Check lever free play.</li><li>• Adjust if necessary.</li></ul>	6-23-6-24
<b>Throttle grip</b>	<ul style="list-style-type: none"><li>• Make sure that operation is smooth.</li><li>• Check cable free play.</li><li>• If necessary, have Yamaha dealer adjust cable free play and lubricate cable and grip housing.</li></ul>	6-18, 6-31

# PRE-OPERATION CHECKS

ITEM	CHECKS	PAGE
Control cables	<ul style="list-style-type: none"> <li>• Make sure that operation is smooth.</li> <li>• Lubricate if necessary.</li> </ul>	6-31
Wheels and tires	<ul style="list-style-type: none"> <li>• Check for damage.</li> <li>• Check tire condition and tread depth.</li> <li>• Check air pressure.</li> <li>• Correct if necessary.</li> </ul>	6-19-6-22
Brake and shift pedals	<ul style="list-style-type: none"> <li>• Make sure that operation is smooth.</li> <li>• Lubricate pedal pivoting points if necessary.</li> </ul>	6-31
Brake and clutch levers	<ul style="list-style-type: none"> <li>• Make sure that operation is smooth.</li> <li>• Lubricate lever pivoting points if necessary.</li> </ul>	6-32
Sidestand	<ul style="list-style-type: none"> <li>• Make sure that operation is smooth.</li> <li>• Lubricate pivot if necessary.</li> </ul>	6-33
Chassis fasteners	<ul style="list-style-type: none"> <li>• Make sure that all nuts, bolts and screws are properly tightened.</li> <li>• Tighten if necessary.</li> </ul>	—
Instruments, lights, signals and switches	<ul style="list-style-type: none"> <li>• Check operation.</li> <li>• Correct if necessary.</li> </ul>	—
Sidestand switch	<ul style="list-style-type: none"> <li>• Check operation of ignition circuit cut-off system.</li> <li>• If system is defective, have Yamaha dealer check vehicle.</li> </ul>	3-15

**NOTE:**

Pre-operation checks should be made each time the motorcycle is used. Such an inspection can be accomplished in a very short time; and the added safety it assures is more than worth the time involved.

EWA00033



**WARNING**

If any item in the Pre-operation check list is not working properly, have it inspected and repaired before operating the motorcycle.



# OPERATION AND IMPORTANT RIDING POINTS

---

Starting and warming up a cold engine .....	5-1
Shifting .....	5-3
Engine break-in .....	5-5
Parking .....	5-5



EAU00373

## **! WARNING**

- Become thoroughly familiar with all operating controls and their functions before riding. Consult a Yamaha dealer regarding any control or function that you do not thoroughly understand.
- Never start the engine or operate it in a closed area for any length of time. Exhaust fumes are poisonous, and inhaling them can cause loss of consciousness and death within a short time. Always make sure that there is adequate ventilation.

- Before starting out, make sure that the sidestand is up. If the sidestand is not raised completely, it could contact the ground and distract the operator, resulting in a possible loss of control.

EAU00376

## **CAUTION:**

- Make sure not to store personal items near the air cleaner intake, otherwise air intake will be blocked and performance will suffer.
- Make sure not to put anything near the battery and its terminals, otherwise electrical failure and acid corrosion may result.

EAU04440

## **Starting and warming up a cold engine**

In order for the ignition circuit cut-off system to enable starting, one of the following conditions must be met:

- The transmission is in the neutral position.
- The transmission is in gear with the clutch lever pulled and the sidestand up.

EW000054

## **! WARNING**

- Before starting the engine, check the function of the ignition circuit cut-off system according to the procedure described on page 3-17.
- Never ride with the sidestand down.

1. Turn the key to "ON" and make sure that the engine stop switch is set to "○".

# OPERATION AND IMPORTANT RIDING POINTS

ECA00124

## CAUTION:

The fuel level warning light and engine trouble warning light should come on for a few seconds, then go off. If a warning light does not go off, see pages 3-2 and 3-3 for the corresponding warning light circuit check.

2. Shift the transmission into the neutral position.

## NOTE:

When the transmission is in the neutral position, the neutral indicator light should be on, otherwise have a Yamaha dealer check the electrical circuit.

3. Start the engine by pushing the start switch.

## NOTE:

If the engine fails to start, release the start switch, wait a few seconds, and then try again. Each starting attempt should be as short as possible to preserve the battery. Do not crank the engine more than 10 seconds on any one attempt.

ECA00055

## CAUTION:

For maximum engine life, always warm the engine up before starting off. Never accelerate hard when the engine is cold!

## NOTE:

The engine is warm when it quickly responds to the throttle.

# OPERATION AND IMPORTANT RIDING POINTS

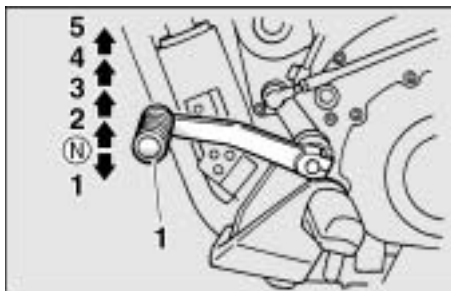

1. Shift pedal  
N. Neutral position

EAU00423

## 5 Shifting

Shifting gears lets you control the amount of engine power available for starting off, accelerating, climbing hills, etc.

The gear positions are shown in the illustration.

### NOTE:

To shift the transmission into the neutral position, press the shift pedal down repeatedly until it reaches the end of its travel, and then slightly raise it.

EC000048

### CAUTION:

- Even with the transmission in the neutral position, do not coast for long periods of time with the engine off, and do not tow the motorcycle for long distances. The transmission is properly lubricated only when the engine is running. Inadequate lubrication may damage the transmission.
- Always use the clutch while changing gears to avoid damaging the engine, transmission, and drive train, which are not designed to withstand the shock of forced shifting.

EAU02988

### To start out and accelerate

1. Pull the clutch lever to disengage the clutch.
2. Shift the transmission into first gear. The neutral indicator light should go out.
3. Open the throttle gradually, and at the same time, release the clutch lever slowly.
4. At the recommended shift points shown in the table on page 5-4, close the throttle, and at the same time, quickly pull the clutch lever in.
5. Shift the transmission into second gear. (Make sure not to shift the transmission into the neutral position.)
6. Open the throttle part way and gradually release the clutch lever.
7. Follow the same procedure when shifting to the next higher gear.

### NOTE:

Always shift gears at the recommended shift points.



# OPERATION AND IMPORTANT RIDING POINTS

EAU00427

## To decelerate

1. Apply both the front and the rear brakes to slow the motorcycle.
2. Shift the transmission into first gear when the motorcycle reaches 16 mi/h (25 km/h). If the engine is about to stall or runs very roughly, pull the clutch lever in and use the brakes to stop the motorcycle.
3. Shift the transmission into the neutral position when the motorcycle is almost completely stopped. The neutral indicator light should come on.

EAU02974

## Recommended shift points

The recommended shift points during acceleration and deceleration are shown in the table below.

	Acceleration shift point mi/h (km/h)	Deceleration shift point mi/h (km/h)
1st → 2nd	13 (20)	16 (25)
2nd → 3rd	19 (30)	16 (25)
3rd → 4th	25 (40)	16 (25)
4th → 5th	31 (50)	16 (25)

# OPERATION AND IMPORTANT RIDING POINTS

---

## Engine break-in

EAU01128

There is never a more important period in the life of your engine than the period between 0 and 1,000 mi (1,600 km). For this reason, you should read the following material carefully.

Since the engine is brand new, do not put an excessive load on it for the first 1,000 mi (1,600 km). The various parts in the engine wear and polish themselves to the correct operating clearances. During this period, prolonged full-throttle operation or any condition that might result in engine overheating must be avoided.

### 0–600 mi (0–1,000 km)

EAU04441\*

Avoid prolonged operation above 2,500 r/min.

### 600–1,000 mi (1,000–1,600 km)

Avoid prolonged operation above 3,500 r/min.

ECA00026\*

#### **CAUTION:**

**After 600 mi (1,000 km) of operation, the engine oil and transfer case oil must be changed, and the oil filter cartridge replaced.**

### 1,000 mi (1,600 km) and beyond

The vehicle can now be operated normally.

EC000053

#### **CAUTION:**

- Keep the engine speed out of the tachometer red zone.
- If any engine trouble should occur during the engine break-in period, immediately have a Yamaha dealer check the vehicle.

## Parking

EAU00461

When parking, stop the engine, and then remove the key from the main switch.

EW000058

#### **WARNING**

- Since the engine and exhaust system can become very hot, park in a place where pedestrians or children are not likely to touch them.
- Do not park on a slope or on soft ground, otherwise the motorcycle may overturn.

EC000062

#### **CAUTION:**

**Never park in an area where there are fire hazards such as grass or other flammable materials.**

# PERIODIC MAINTENANCE AND MINOR REPAIR

Periodic maintenance .....	6-1	Drive belt slack .....	6-29
Owner's tool kit .....	6-2	Checking and lubricating the cables .....	6-31
Periodic maintenance chart for the emission control system .....	6-3	Checking and lubricating the throttle grip and cable .....	6-31
General maintenance and lubrication chart .....	6-4	Checking and lubricating the brake and shift pedals .....	6-31
Checking the spark plugs .....	6-7	Checking and lubricating the brake and clutch levers .....	6-32
Canister (for California only) .....	6-8	Checking and lubricating the sidestand .....	6-33
Engine oil and oil filter cartridge .....	6-9	Lubricating the rear suspension .....	6-33
Transfer case oil .....	6-13	Checking the front fork .....	6-33
Replacing the air filter elements .....	6-13	Checking the steering .....	6-34
Adjusting the throttle cable free play .....	6-18	Checking the wheel bearings .....	6-35
Adjusting the valve clearance .....	6-19	Battery .....	6-35
Tires .....	6-19	Replacing the fuses .....	6-37
Cast wheels .....	6-22	Replacing the headlight bulb .....	6-38
Accessories and replacement parts .....	6-23	Tail/brake light .....	6-40
Adjusting the clutch lever free play .....	6-23	Replacing a turn signal light bulb .....	6-40
Adjusting the brake lever free play .....	6-24	Replacing a license plate light bulb .....	6-41
Adjusting the brake pedal position .....	6-25	Supporting the motorcycle .....	6-42
Adjusting the rear brake light switch .....	6-25	Troubleshooting .....	6-42
Checking the front and rear brake pads .....	6-26	Troubleshooting chart .....	6-43
Checking the brake fluid level .....	6-27		
Changing the brake fluid .....	6-28		

EAU01790

Safety is an obligation of the owner. Periodic inspection, adjustment and lubrication will keep your vehicle in the safest and most efficient condition possible. The most important points of motorcycle inspection, adjustment, and lubrication are explained on the following pages.

**Maintenance, replacement, or repair of the emission control devices and systems may be performed by any repair establishment or individual that is certified (if applicable).**

EW000060

## **! WARNING**

**If you are not familiar with motorcycle maintenance work, have a Yamaha dealer do it for you.**



EAU00467

## **PERIODIC MAINTENANCE**

PROPER PERIODIC MAINTENANCE OF YOUR MOTORCYCLE IS IMPORTANT IN ORDER TO ENJOY LONG, PLEASURABLE SERVICE. ESPECIALLY IMPORTANT ARE THE MAINTENANCE SERVICES RELATED TO EMISSIONS CONTROL. THESE CONTROLS NOT ONLY FUNCTION TO ENSURE CLEANER AIR, BUT ARE ALSO VITAL TO PROPER ENGINE OPERATION AND MAXIMUM PERFORMANCE. IN THE FOLLOWING PERIODIC MAINTENANCE CHARTS, THE SERVICES RELATED TO EMISSIONS CON-

TROL ARE GROUPED SEPARATELY. THESE SERVICES REQUIRE SPECIALIZED DATA, KNOWLEDGE, AND EQUIPMENT. YAMAHA DEALERS ARE TRAINED AND EQUIPPED TO PERFORM THESE PARTICULAR SERVICES.

# PERIODIC MAINTENANCE AND MINOR REPAIR

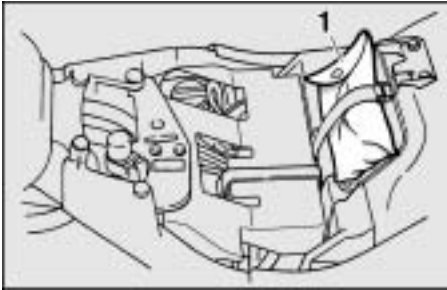

1. Owner's tool kit

EAU03983

## Owner's tool kit

The owner's tool kit is located under the seat. (See page 3-11 for seat removal and installation procedures.)

The service information included in this manual and the tools provided in the owner's tool kit are intended to assist you in the performance of preventive maintenance and minor repairs. However, additional tools such as a torque wrench may be necessary to perform certain maintenance work correctly.

**NOTE:** \_\_\_\_\_  
If you do not have the tools or experience required for a particular job, have a Yamaha dealer perform it for you.

EW000062

## **⚠ WARNING** \_\_\_\_\_

**Modifications not approved by Yamaha may cause loss of performance, excessive emissions, and render the vehicle unsafe for use. Consult a Yamaha dealer before attempting any changes.**

# PERIODIC MAINTENANCE AND MINOR REPAIR

EAU00471

## Periodic maintenance chart for the emission control system

No.	ITEM	ROUTINE	INITIAL	ODOMETER READINGS					
			600 mi (1,000 km) or 1 month	4,000 mi (7,000 km) or 6 months	8,000 mi (13,000 km) or 12 months	12,000 mi (19,000 km) or 18 months	16,000 mi (25,000 km) or 24 months	20,000 mi (31,000 km) or 30 months	
1	* Valve clearance	<ul style="list-style-type: none"> <li>Check valve clearance when engine is cold.</li> <li>Adjust if necessary.</li> </ul>	Every 16,000 mi (25,000 km)						
2	* Spark plugs	<ul style="list-style-type: none"> <li>Check condition.</li> <li>Adjust gap and clean.</li> <li>Replace at 8,000 mi (13,000 km) or 12 months and thereafter every 8,000 mi (13,000 km) or 12 months.</li> </ul>		✓	Replace.	✓	Replace.	✓	
3	* Crankcase ventilation system	<ul style="list-style-type: none"> <li>Check ventilation hose for cracks or damage.</li> <li>Replace if necessary.</li> </ul>		✓	✓	✓	✓	✓	
4	* Fuel line	<ul style="list-style-type: none"> <li>Check fuel hose for cracks or damage.</li> <li>Replace if necessary.</li> </ul>		✓	✓	✓	✓	✓	
5	* Exhaust system	<ul style="list-style-type: none"> <li>Check for leakage.</li> <li>Tighten if necessary.</li> <li>Replace gasket(s) if necessary.</li> </ul>		✓	✓	✓	✓	✓	
6	* Electronic fuel injection	<ul style="list-style-type: none"> <li>Check and adjust engine idle speed and synchronization.</li> <li>Adjust cable free play.</li> </ul>	✓	✓	✓	✓	✓	✓	
7	* Evaporative Emission control system (For California only)	<ul style="list-style-type: none"> <li>Check control system for damage.</li> <li>Replace if necessary.</li> </ul>				✓		✓	

\* Since these items require special tools, data and technical skills, have a Yamaha dealer perform the service.

# PERIODIC MAINTENANCE AND MINOR REPAIR

EAU00472

## General maintenance and lubrication chart

No.	ITEM	ROUTINE	TYPE	INITIAL	ODOMETER READINGS					
				600 mi (1,000 km) or 1 month	4,000 mi (7,000 km) or 6 months	8,000 mi (13,000 km) or 12 months	12,000 mi (19,000 km) or 18 months	16,000 mi (25,000 km) or 24 months	20,000 mi (31,000 km) or 30 months	
1	Engine oil	<ul style="list-style-type: none"> <li>Change.</li> </ul>	See page 8-1.	√	√	√	√	√	√	
2	* Engine oil filter cartridge	<ul style="list-style-type: none"> <li>Replace.</li> </ul>	-	√		√		√		
3	* Air filter elements	<ul style="list-style-type: none"> <li>Check condition and for damage. (See NOTE on page 6-6.)</li> <li>Replace if necessary.</li> </ul>	-		√	√	√	√	√	
4	* Front brake	<ul style="list-style-type: none"> <li>Check operation and fluid leakage. (See NOTE page 6-6.)</li> <li>Correct if necessary.</li> </ul>	-	√	√	√	√	Replace brake fluid.	√	
5	* Rear brake	<ul style="list-style-type: none"> <li>Check operation and fluid leakage. (See NOTE page 6-6.)</li> <li>Correct if necessary.</li> </ul>	-	√	√	√	√	Replace brake fluid.	√	
6	* Clutch	<ul style="list-style-type: none"> <li>Check operation and free play.</li> <li>Correct if necessary.</li> </ul>	-	√	√	√	√	√	√	
7	* Transfer case oil	<ul style="list-style-type: none"> <li>Check vehicle for leakage.</li> <li>Replace every 16,000 mi (25,000 km) or 24 months.</li> </ul>	SAE 80 API "GL-4" hypoid gear oil	Change.		Check.		Change.		
8	* Throttle grip housing and cable	<ul style="list-style-type: none"> <li>Check operation and free play.</li> <li>Adjust the throttle cable free play if necessary.</li> <li>Lubricate the throttle grip housing and cable.</li> </ul>	-		√	√	√	√	√	

\* Since these items require special tools, data and technical skills, have a Yamaha dealer perform the service.

# PERIODIC MAINTENANCE AND MINOR REPAIR

No.	ITEM	ROUTINE	TYPE	INITIAL	ODOMETER READINGS					
				600 mi (1,000 km) or 1 month	4,000 mi (7,000 km) or 6 months	8,000 mi (13,000 km) or 12 months	12,000 mi (19,000 km) or 18 months	16,000 mi (25,000 km) or 24 months	20,000 mi (31,000 km) or 30 months	
9	* Control cables	<ul style="list-style-type: none"> <li>Apply chain lube thoroughly.</li> </ul>	Yamaha Chain and Cable Lube or engine oil SAE 10W-30 (API SE)	√	√	√	√	√	√	
10	* Rear arm pivot bearing	<ul style="list-style-type: none"> <li>Check bearing assembly for looseness.</li> <li>Moderately repack every 16,000 mi (25,000 km) or 24 months.</li> </ul>	Lithium-soap-based grease			√		<b>Repack.</b>		
11	Brake and clutch lever pivot shafts	<ul style="list-style-type: none"> <li>Lubricate.</li> <li>Apply grease lightly.</li> </ul>	Lithium-soap-based grease (all-purpose grease)		√	√	√	√	√	
12	Brake pedal and shift pedal shafts	<ul style="list-style-type: none"> <li>Lubricate.</li> <li>Apply grease lightly.</li> </ul>	Lithium-soap-based grease (all-purpose grease)		√	√	√	√	√	
13	* Sidestand pivot	<ul style="list-style-type: none"> <li>Check operation and lubricate.</li> <li>Apply grease lightly.</li> </ul>	Lithium-soap-based grease (all-purpose grease)		√	√	√	√	√	
14	* Sidestand switch	<ul style="list-style-type: none"> <li>Check and clean or replace if necessary.</li> </ul>	-	√	√	√	√	√	√	
15	* Front fork	<ul style="list-style-type: none"> <li>Check operation and for leakage.</li> </ul>	-		√	√	√	√	√	
16	* Steering bearings	<ul style="list-style-type: none"> <li>Check bearing assembly for looseness.</li> <li>Moderately repack every 16,000 mi (25,000 km) or 24 months.</li> </ul>	Lithium-soap-based grease (all-purpose grease)		√	√	√	<b>Repack.</b>	√	
17	* Wheel bearings	<ul style="list-style-type: none"> <li>Check bearings for smooth rotation.</li> </ul>	-		√	√	√	√	√	
18	* Rear suspension link pivots	<ul style="list-style-type: none"> <li>Lubricate.</li> <li>Apply grease lightly.</li> </ul>	Lithium-soap-based grease					√		

\* Since these items require special tools, data and technical skills, have a Yamaha dealer perform the service.



# PERIODIC MAINTENANCE AND MINOR REPAIR

No.	ITEM	ROUTINE	TYPE	INITIAL	ODOMETER READINGS						
				600 mi (1,000 km) or 1 month	4,000 mi (7,000 km) or 6 months	8,000 mi (13,000 km) or 12 months	12,000 mi (19,000 km) or 18 months	16,000 mi (25,000 km) or 24 months	20,000 mi (31,000 km) or 30 months		
19	*	Drive belt	<ul style="list-style-type: none"> <li>• Check belt tension.</li> <li>• Adjust if necessary.</li> </ul>	-	√	Every 2,500 mi (4,000 km)					

\* Since these items require special tools, data and technical skills, have a Yamaha dealer perform the service.

EAU03907

**NOTE:**

From 24,000 mi (37,000 km) or 36 months, repeat the maintenance intervals starting from 4,000 mi (7,000 km) or 6 months.

EAU04443

**NOTE:**

- Air filters
  - This model's air filters are equipped with disposable oil-coated paper elements, which must not be cleaned with compressed air to avoid damaging them.
  - The air filter elements need to be replaced more frequently when riding in unusually wet or dusty areas.
- Hydraulic brake service
  - After disassembling the brake master cylinders and calipers, always change the fluid. Regularly check the brake fluid levels and fill the reservoirs as required.
  - Every two years replace the internal components of the brake master cylinders and calipers, and change the brake fluid.
  - Replace the brake hoses every four years and if cracked or damaged.

# PERIODIC MAINTENANCE AND MINOR REPAIR

EAU01880

## Checking the spark plugs

The spark plugs are important engine components, which should be checked periodically, preferably by a Yamaha dealer. Since heat and deposits will cause any spark plug to slowly erode, they should be removed and checked in accordance with the periodic maintenance and lubrication chart. In addition, the condition of the spark plugs can reveal the condition of the engine.

The porcelain insulator around the center electrode of each spark plug should be a medium-to-light tan (the ideal color when the motorcycle is ridden normally), and all spark plugs installed in the engine should have the same color. If any spark plug shows a distinctly different color, the engine could be defective. Do not attempt to diagnose such problems yourself. Instead, have a Yamaha dealer check the motorcycle.

If a spark plug shows signs of electrode erosion and excessive carbon or other deposits, it should be replaced.

Specified spark plug:  
DPR7EA-9/NGK or  
X22EPR-U9/DENSO

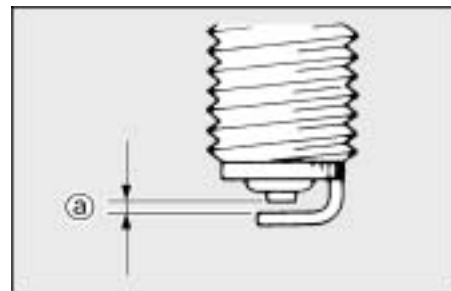

a. Spark plug gap

Before installing a spark plug, the spark plug gap should be measured with a wire thickness gauge and, if necessary, adjusted to specification.

Spark plug gap:  
0.03–0.04 in (0.8–0.9 mm)

Clean the surface of the spark plug gasket and its mating surface, and then wipe off any grime from the spark plug threads.

Tightening torque:  
Spark plug:  
12.7 ft·lbf (1.75 m·kgf, 17.5 Nm)

# PERIODIC MAINTENANCE AND MINOR REPAIR

## NOTE:

If a torque wrench is not available when installing a spark plug, a good estimate of the correct torque is 1/4–1/2 turn past finger tight. However, the spark plug should be tightened to the specified torque as soon as possible.

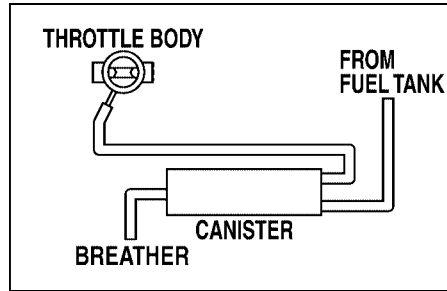

EAU00499

## Canister (for California only)

This model is equipped with a canister to prevent the discharging of fuel vapor into the atmosphere. Before operating this motorcycle, make sure to check the following:

- Check each hose connection.
- Check each hose and canister for cracks or damage. Replace if damaged.
- Make sure that the canister breather is not blocked, and if necessary, clean it.

# PERIODIC MAINTENANCE AND MINOR REPAIR

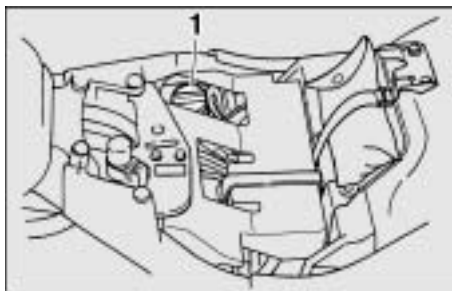

1. Engine oil filler cap

EAU04909

## Engine oil and oil filter cartridge

The engine oil level should be checked before each ride. In addition, the oil must be changed and the oil filter cartridge replaced at the intervals specified in the periodic maintenance and lubrication chart.

### To check the engine oil level

1. Place the motorcycle on a level surface and hold it in an upright position.

**NOTE:**  
Make sure that the motorcycle is positioned straight up when checking the oil level. A slight tilt to the side can result in a false reading.

2. Remove the seat. (See page 3-11 for seat removal and installation procedures.)
3. Start the engine, warm it up until the engine oil has reached a normal temperature of 140 °F (60 °C), let it continue to idle for ten seconds, and then turn the engine off.

**NOTE:**  
To achieve the proper engine oil temperature for an accurate oil level reading, the engine must have first completely cooled down, and then warmed up again for several minutes to normal operating temperature.



1. Maximum level mark  
2. Minimum level mark  
3. Dipstick

4. Wait a few minutes until the oil settles, remove the oil filler cap, wipe the dipstick clean, insert it back into the oil filler hole (without screwing it in), and then remove it again to check the oil level.

**NOTE:**  
The engine oil should be between the minimum and maximum level marks.

5. If the engine oil is below the minimum level mark, add sufficient oil of the recommended type to raise it to the correct level.

# PERIODIC MAINTENANCE AND MINOR REPAIR

## NOTE:

When adding oil, be careful not to overfill the engine oil tank; the oil level rises faster starting from the half level portion on the dipstick.

6. Insert the dipstick into the oil filler hole, and then tighten the oil filler cap.
7. Install the seat.

ECA00027

## CAUTION:

**Make sure that the oil filler cap is securely tightened, otherwise oil may seep out when the engine is running.**

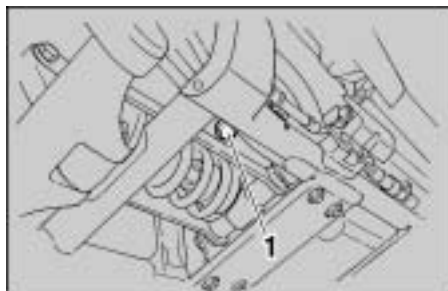

1. Engine oil drain bolt (oil tank)

## To change the engine oil (with or without oil filter cartridge replacement)

1. Remove the seat. (See page 3-11 for seat removal and installation procedures.)
2. Start the engine, warm it up for several minutes, and then turn it off.
3. Place an oil pan under the oil tank to collect the used oil.
4. Remove the engine oil filler cap and drain bolt to drain the oil from the oil tank.

## NOTE:

Skip steps 5–9 if the oil filter cartridge is not being replaced.

# PERIODIC MAINTENANCE AND MINOR REPAIR



1. Engine oil drain bolt (crankcase)

5. Place an oil pan under the engine to collect the used oil.
6. Remove the engine oil drain bolt to drain the oil from the crankcase.

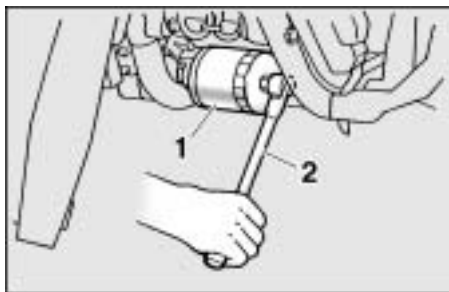

1. Oil filter cartridge  
2. Oil filter wrench

7. Remove the oil filter cartridge with an oil filter wrench.

**NOTE:** \_\_\_\_\_  
An oil filter wrench is available at a Yamaha dealer.

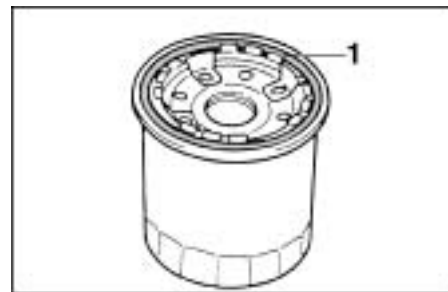

1. O-ring

8. Apply a thin coat of engine oil to the O-ring of the new oil filter cartridge.

**NOTE:** \_\_\_\_\_  
Make sure that the O-ring is properly seated.

# PERIODIC MAINTENANCE AND MINOR REPAIR

ECA00133

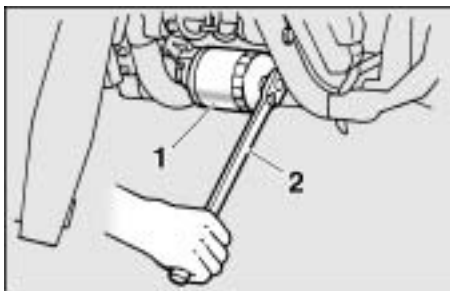

1. Oil filter cartridge
2. Torque wrench

9. Install the new oil filter cartridge, and then tighten it to the specified torque with a torque wrench.

Tightening torque:

Oil filter cartridge:

12 ft·lbf (1.7 m·kgf, 17 Nm)

10. Install the engine oil drain bolts, and then tighten them to the specified torque.

Tightening torque:

Engine oil drain bolts:

31 ft·lbf (4.3 m·kgf, 43 Nm)

11. Pour only 2.6 US qt (2.2 Imp qt, 2.5 L) of the specified amount of recommended engine oil through the filler hole, insert the dipstick, and then tighten the oil filler cap.
12. Start the engine, rev it several times, and then turn it off.
13. Remove the engine oil filler cap, and then gradually fill the oil tank with the remaining oil quantity while regularly checking the oil level on the dipstick.

Recommended engine oil:

See page 8-1.

Oil quantity:

Without oil filter cartridge replacement:

3.9 US qt (3.3 Imp qt, 3.7 L)

With oil filter cartridge replacement:

4.3 US qt (3.6 Imp qt, 4.1 L)

Total amount (dry engine):

5.3 US qt (4.4 Imp qt, 5.0 L)

## CAUTION:

- In order to prevent clutch slippage (since the engine oil also lubricates the clutch), do not mix any chemical additives. Do not use oils with a diesel specification of “CD” or oils of a higher quality than specified. In addition, do not use oils labeled “ENERGY CONSERVING II” or higher.
- Make sure that no foreign material enters the crankcase.

14. Install the engine oil filler cap.
15. Start the engine, and then let it idle for several minutes while checking it for oil leakage. If oil is leaking, immediately turn the engine off and check for the cause.
16. Turn the engine off, and then check the oil level and correct it if necessary.
17. Install the seat.

# PERIODIC MAINTENANCE AND MINOR REPAIR

## Transfer case oil

EAU04439

Have the transfer case oil level checked and the oil changed by a Yamaha dealer at the intervals specified in the periodic maintenance and lubrication chart.

## Replacing the air filter elements

EAU04447\*

This motorcycle is equipped with two air filter elements, one of which is located in the air filter case, the other is located in the silencer case.

The air filter elements should be replaced at the intervals specified in the periodic maintenance and lubrication chart. Replace the air filter elements more frequently if you are riding in unusually wet or dusty areas.

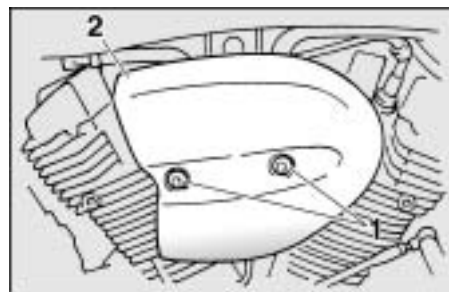

1. Bolt (× 2)
2. Air induction system cover

2. Remove the air induction system cover by removing the bolts.

## Air filter case element

### To replace the air filter element

1. Remove the seat. (See page 3-11 for seat removal and installation procedures.)



# PERIODIC MAINTENANCE AND MINOR REPAIR

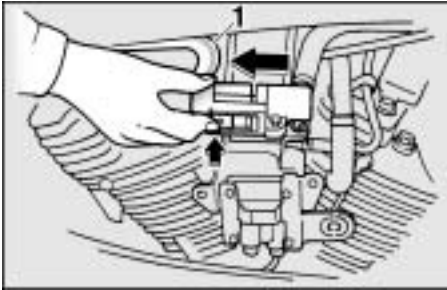

1. Fuel hose A

3. Remove the fuel tank as follows.
  - a. Disconnect fuel hose A from the joint as shown.

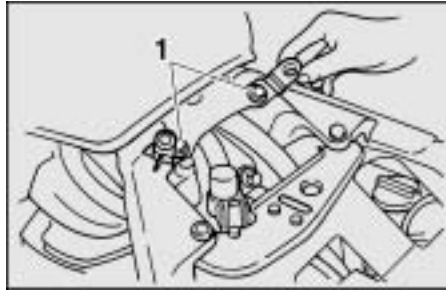

1. Nut (× 2)

- b. Remove the nuts.

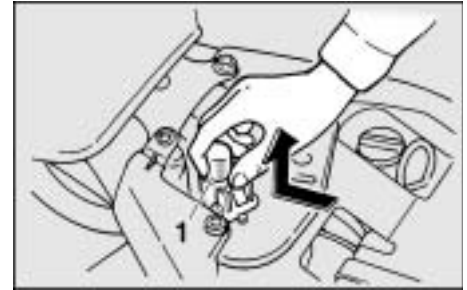

1. Fuel hose B

- c. Disconnect fuel hose B from the joint as shown.

ECA00121

## CAUTION:

- Place a towel or cloth under the fuel hose joints when disconnecting hoses A and B to prevent fuel from spilling onto the vehicle.
- Make sure that no foreign material enters the fuel hose joints when the hoses are disconnected.

# PERIODIC MAINTENANCE AND MINOR REPAIR

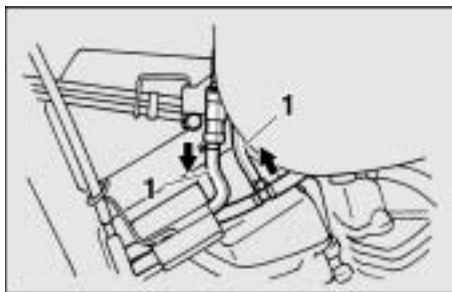

1. Hose (× 2)

d. Remove the hoses as shown, and then remove the fuel tank by pulling it upward.

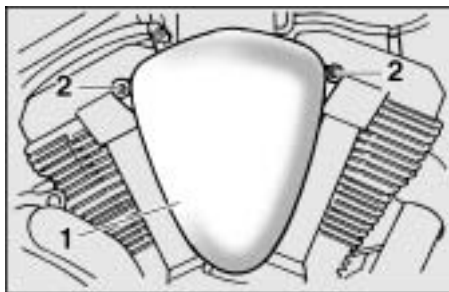

1. Air filter case

2. Bolt (× 2)

4. Remove the air filter case bolts.

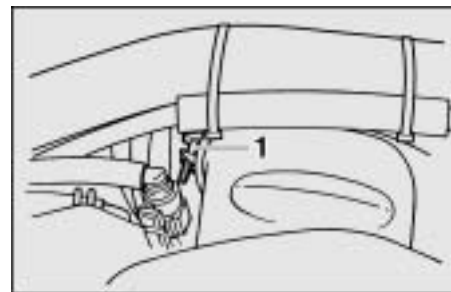

1. Air filter joint clamp screw

5. Loosen the air filter joint clamp screw, and then pull off the air filter case.

# PERIODIC MAINTENANCE AND MINOR REPAIR

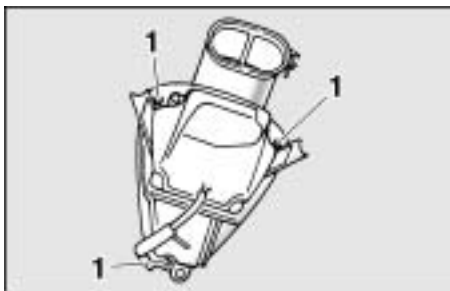

1. Screw (× 3)

6. Remove the air filter case cover by removing the screws.

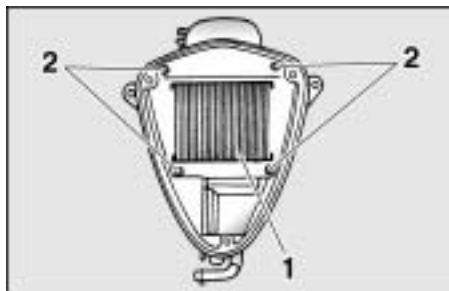

1. Air filter element  
2. Screw (× 4)

7. Remove the air filter element by removing the screws.
8. Install a new air filter element by inserting it into the air filter case, then installing the screws.

EC000082\*

## CAUTION:

- Make sure that the air filter element is properly seated in the air filter case.
- The engine should never be operated without the air filter element installed, otherwise the pistons and/or cylinders may become excessively worn.

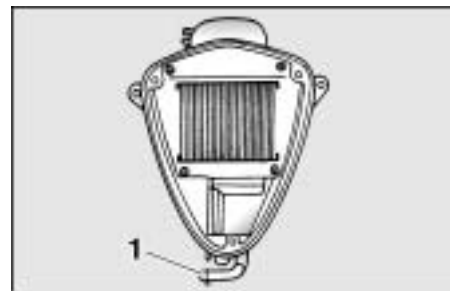

1. Air filter check hose

9. Remove the clamp from the check hose, and then remove the plug to drain any accumulated water.
10. Install the plug and the clamp.
11. Install the air filter case cover by installing the screws.
12. Install the air filter case by pushing it onto the air filter joint, and then tightening the air filter joint clamp screw.
13. Install the air filter case by installing the bolts.

# PERIODIC MAINTENANCE AND MINOR REPAIR

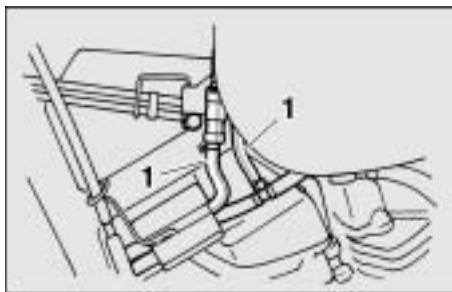

1. Hose (× 2)

14. Install the fuel tank as follows.

- a. Place the fuel tank in the original position, and then connect fuel hose B and the hoses shown.

EW000072

## **⚠ WARNING**

- Before installing the fuel tank, make sure that the fuel hoses are not damaged. If any fuel hose is damaged, do not start the engine but have a Yamaha dealer replace the hose, otherwise fuel may leak.
- Make sure that the fuel hoses are properly connected and routed, and not pinched.

- b. Install the nuts.
  - c. Connect fuel hose A.
15. Install the air induction system cover by installing the bolts.
16. Install the seat.

## **Silencer case air filter element**

### To replace the air filter element

1. Remove the fuel tank. (See steps 1–3 under “Air filter case element”.)

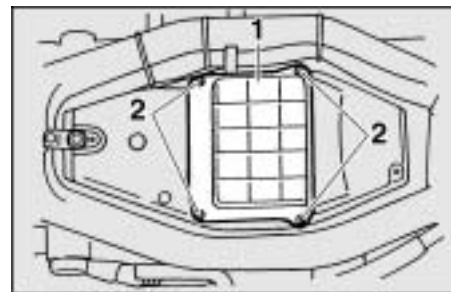

1. Silencer air filter case cover

2. Screw (× 4)

2. Remove the silencer air filter case cover by removing the screws.

# PERIODIC MAINTENANCE AND MINOR REPAIR

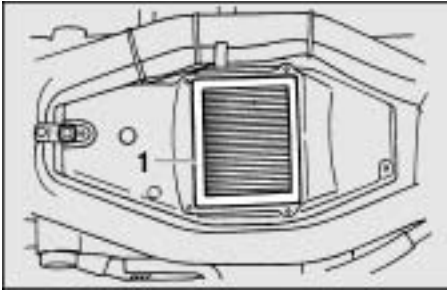

1. Silencer air filter element

3. Remove the silencer air filter element.
4. Install a new air filter element by inserting it into the air filter case.

EC000082\*

## CAUTION:

- **Make sure that the air filter element is properly seated in the air filter case.**
- **The engine should never be operated without the air filter element installed, otherwise the pistons and/or cylinders may become excessively worn.**

5. Install the silencer air filter case cover by installing the screws.
6. Install the fuel tank. (See step 14 under “Air filter case element”.)

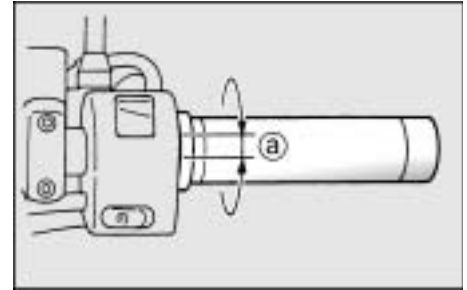

a. Throttle cable free play

EAU00635

## Adjusting the throttle cable free play

The throttle cable free play should measure 0.16–0.24 in (4–6 mm) at the throttle grip. Periodically check the throttle cable free play and, if necessary, have a Yamaha dealer adjust it.

# PERIODIC MAINTENANCE AND MINOR REPAIR

## Adjusting the valve clearance

EAU00637

The valve clearance changes with use, resulting in improper air-fuel mixture and/or engine noise. To prevent this from occurring, the valve clearance must be adjusted by a Yamaha dealer at the intervals specified in the periodic maintenance and lubrication chart.

## Tires

EAU03581

To maximize the performance, durability, and safe operation of your motorcycle, note the following points regarding the specified tires.

### Tire air pressure

The tire air pressure should be checked and, if necessary, adjusted before each ride.

EW00082

### **WARNING**

- The tire air pressure must be checked and adjusted on cold tires (i.e., when the temperature of the tires equals the ambient temperature).
- The tire air pressure must be adjusted in accordance with the riding speed and with the total weight of rider, passenger, cargo, and accessories approved for this model.

Tire air pressure (measured on cold tires)		
Load*	Front	Rear
Up to 198 lb (90 kg)	36 psi (2.50 kgf/cm <sup>2</sup> , 250 kPa)	36 psi (2.50 kgf/cm <sup>2</sup> , 250 kPa)
198 lb (90 kg)– maximum	36 psi (2.50 kgf/cm <sup>2</sup> , 250 kPa)	42 psi (2.90 kgf/cm <sup>2</sup> , 290 kPa)
High-speed riding	36 psi (2.50 kgf/cm <sup>2</sup> , 250 kPa)	36 psi (2.50 kgf/cm <sup>2</sup> , 250 kPa)
Maximum load*	408 lb (185 kg)	

\* Total weight of rider, passenger, cargo and accessories

# PERIODIC MAINTENANCE AND MINOR REPAIR

EW000083

## **⚠ WARNING**

Proper loading of your motorcycle is important for several characteristics of your motorcycle, such as handling, braking, performance and safety. Do not carry loosely packed items that can shift. Securely pack your heaviest items close to the center of the motorcycle, and distribute the weight evenly from side to side. Properly adjust the suspension for your load, and check the condition and pressure of your tires. **NEVER OVERLOAD YOUR MOTORCYCLE.** Make sure that the total weight of the cargo, rider, passenger, and accessories (cowling, saddlebags, etc. if approved for this model) does not exceed the maximum load of the motorcycle. Operation of an overloaded motorcycle could cause tire damage, an accident, or even injury.

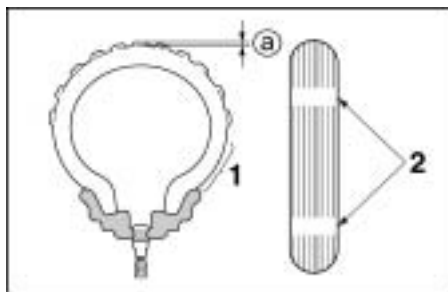

1. Tire sidewall
2. Tire wear indicator
- a. Tire tread depth

### **Tire inspection**

Always check the tires before operating the motorcycle. If a tire tread shows crosswise lines (minimum tread depth), if the tire has a nail or glass fragments in it, or if the sidewall is cracked, contact a Yamaha dealer immediately and have the tire replaced.

Minimum tire tread depth (front and rear)	0.04 in (1.0 mm)
--	------------------

EW000094

## **⚠ WARNING**

- It is dangerous to ride with a worn-out tire. When a tire tread begins to show crosswise lines, have a Yamaha dealer replace the tire immediately.
- The replacement of all wheel- and brake-related parts, including the tires, should be left to a Yamaha dealer, who has the necessary professional knowledge and experience.

# PERIODIC MAINTENANCE AND MINOR REPAIR

EW000080

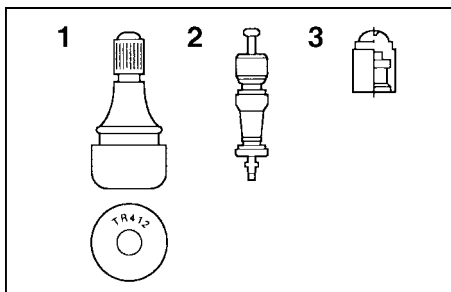

1. Tire air valve
2. Tire air valve core
3. Tire air valve cap with seal

## Tire information

This motorcycle is equipped with cast wheels and tubeless tires with valves.

### **⚠ WARNING**

- The front and rear tires should be of the same make and design, otherwise the handling characteristics of the motorcycle cannot be guaranteed.
- After extensive tests, only the tires listed below have been approved for this model by Yamaha Motor Co., Ltd.
- Always make sure that the valve caps are securely installed to prevent air pressure leakage.
- Use only the tire valves and valve cores listed below to avoid tire deflation during a high-speed ride.

### FRONT

Manufacturer	Size	Model
Bridgestone	120/70 ZR18 (59W)	BT020F G
	120/70 ZR18 M/C (59W)	
Dunlop	120/70 ZR18 (59W)	D220F ST G
	120/70 ZR18 M/C (59W)	

### REAR

Manufacturer	Size	Model
Bridgestone	200/50 ZR17 (75W)	BT020R
	200/50 ZR17 M/C (75W)	
Dunlop	200/50 ZR17 (75W)	D220 ST
	200/50 ZR17 M/C (75W)	

### FRONT & REAR

Tire air valve	TR412
Valve core	#9000A (original)



## **WARNING**

This motorcycle is fitted with super-high-speed tires. Note the following points in order to make the most efficient use of these tires.

- Use only the specified replacement tires. Other tires may run the danger of bursting at super high speeds.
- Brand-new tires can have a relatively poor grip on certain road surfaces until they have been “broken in”. Therefore, it is advisable before doing any high-speed riding to ride conservatively for approximately 60 mi (100 km) after installing a new tire.
- The tires must be warmed up before a high-speed run.
- Always adjust the tire air pressure according to the operating conditions.

## Cast wheels

To maximize the performance, durability, and safe operation of your motorcycle, note the following points regarding the specified wheels.

- The wheel rims should be checked for cracks, bends or warpage before each ride. If any damage is found, have a Yamaha dealer replace the wheel. Do not attempt even the smallest repair to the wheel. A deformed or cracked wheel must be replaced.
- The wheel should be balanced whenever either the tire or wheel has been changed or replaced. An unbalanced wheel can result in poor performance, adverse handling characteristics, and a shortened tire life.
- Ride at moderate speeds after changing a tire since the tire surface must first be “broken in” for it to develop its optimal characteristics.

# PERIODIC MAINTENANCE AND MINOR REPAIR

## Accessories and replacement parts

EAU00691

EW000098

### **⚠ WARNING**

This motorcycle is not designed to pull a trailer or to be attached to a sidecar. The accessories or replacement parts you choose for your motorcycle should be designed specifically for this model, and they must be securely mounted to maintain the inherent stability of the original design. Genuine Yamaha Parts and Accessories are designed and tested to be compatible with your motorcycle. Please consider Genuine Yamaha Parts and Accessories before making a purchase. Use of non-Yamaha-approved accessories or replacement parts may cause loss of handling stability and riding safety.

Since Yamaha cannot control the quality of accessories or parts manufactured by other companies, Yamaha cannot be held liable for any consequences caused by the use of items which have not been approved by Yamaha.

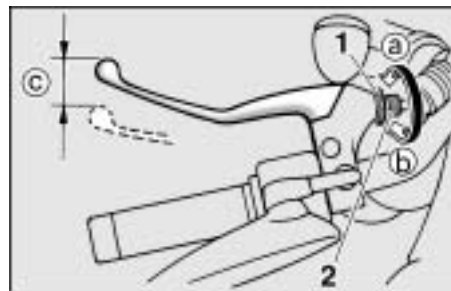

1. Locknut
2. Clutch lever free play adjusting bolt
- c. Clutch lever free play

EAU00694

## Adjusting the clutch lever free play

The clutch lever free play should measure 0.4–0.6 in (10–15 mm) as shown. Periodically check the clutch lever free play and, if necessary, adjust it as follows.

1. Loosen the locknut at the clutch lever.
2. To increase the clutch lever free play, turn the adjusting bolt in direction (a). To decrease the clutch lever free play, turn the adjusting bolt in direction (b).

# PERIODIC MAINTENANCE AND MINOR REPAIR

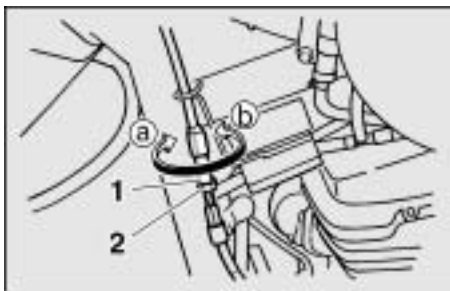

1. Clutch lever free play adjusting nut
2. Locknut

3. If the specified clutch lever free play could be obtained as described above, tighten the locknut and skip the rest of the procedure, otherwise proceed as follows.
4. Fully turn the adjusting bolt at the clutch lever in direction (a) to loosen the clutch cable.
5. Loosen the locknut at the crankcase.
6. To increase the clutch lever free play, turn the adjusting nut in direction (a). To decrease the clutch lever free play, turn the adjusting nut in direction (b).
7. Tighten the locknut at the clutch lever and the crankcase.

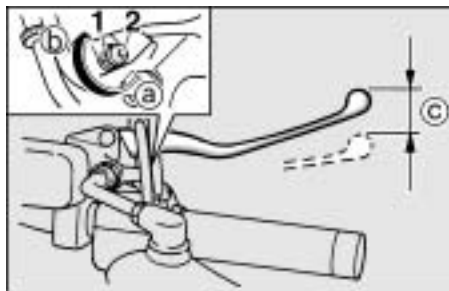

1. Locknut
2. Brake lever free play adjusting bolt
- c. Brake lever free play

EAU00696

## Adjusting the brake lever free play

The brake lever free play should measure 0.08–0.2 in (2–5 mm) as shown. Periodically check the brake lever free play and, if necessary, adjust it as follows.

1. Loosen the locknut at the brake lever.
2. To increase the brake lever free play, turn the adjusting bolt in direction (a). To decrease the brake lever free play, turn the adjusting bolt in direction (b).

3. Tighten the locknut.

EW000099

### **WARNING**

- After adjusting the brake lever free play, check the free play and make sure that the brake is working properly.
- A soft or spongy feeling in the brake lever can indicate the presence of air in the hydraulic system. If there is air in the hydraulic system, have a Yamaha dealer bleed the system before operating the motorcycle. Air in the hydraulic system will diminish the braking performance, which may result in loss of control and an accident.

# PERIODIC MAINTENANCE AND MINOR REPAIR

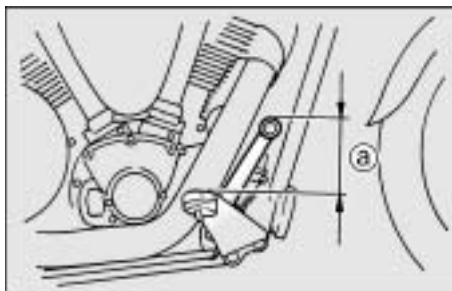

a. Distance between brake pedal and footrest

EAU01746

## Adjusting the brake pedal position

The top of the brake pedal should be positioned approximately 3.0 in (80 mm) above the top of the footrest as shown. Periodically check the brake pedal position and, if necessary, have a Yamaha dealer adjust it.

EW000109

### **⚠ WARNING**

A soft or spongy feeling in the brake pedal can indicate the presence of air in the hydraulic system. If there is air in the hydraulic system, have a Yamaha dealer bleed the system before operating the motorcycle. Air in the hydraulic system will diminish the braking performance, which may result in loss of control and an accident.

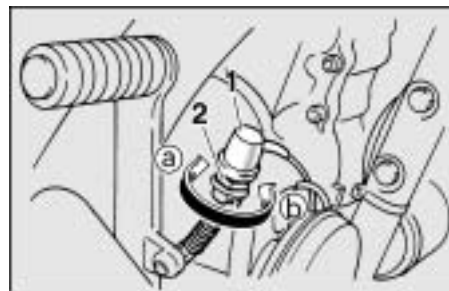

1. Rear brake light switch
2. Rear brake light switch adjusting nut

EAU00713

## Adjusting the rear brake light switch

The rear brake light switch, which is activated by the brake pedal, is properly adjusted when the brake light comes on just before braking takes effect. If necessary, adjust the brake light switch as follows.

Turn the adjusting nut while holding the rear brake light switch in place. To make the brake light come on earlier, turn the adjusting nut in direction **a**. To make the brake light come on later, turn the adjusting nut in direction **b**.

# PERIODIC MAINTENANCE AND MINOR REPAIR

## Checking the front and rear brake pads

EAU00721

The front and rear brake pads must be checked for wear at the intervals specified in the periodic maintenance and lubrication chart.

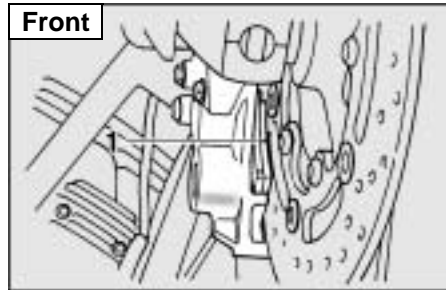

1. Brake pad wear indicator groove

EAU00725

### Front brake pads

Each front brake pad is provided with a wear indicator groove, which allows you to check the brake pad wear without having to disassemble the brake. To check the brake pad wear, check the wear indicator groove. If a brake pad has worn to the point that the wear indicator groove has almost disappeared, have a Yamaha dealer replace the brake pads as a set.

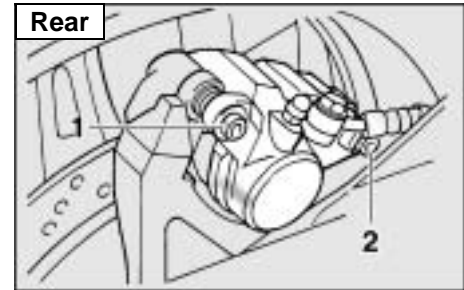

1. Brake caliper bolt A
2. Brake caliper bolt B

EAU04434

### Rear brake pads

1. Remove brake caliper bolt A, loosen brake caliper bolt B, and then tilt the caliper forward.

# PERIODIC MAINTENANCE AND MINOR REPAIR

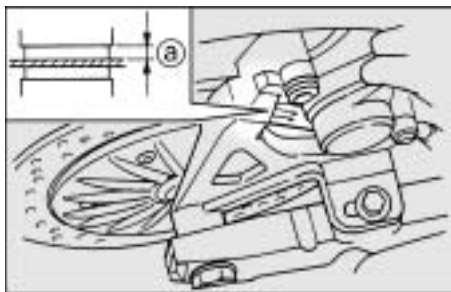

a. Lining thickness

2. Check each brake pad for damage and measure the lining thickness. If a brake pad is damaged or if the lining thickness is less than 0.03 in (0.8 mm), have a Yamaha dealer replace the brake pads as a set.
3. Install brake caliper bolt A, then tighten both caliper bolts to the specified torque.

Tightening torque:  
Brake caliper bolt:  
19.5 ft-lbf (2.7 m-kgf, 27 Nm)

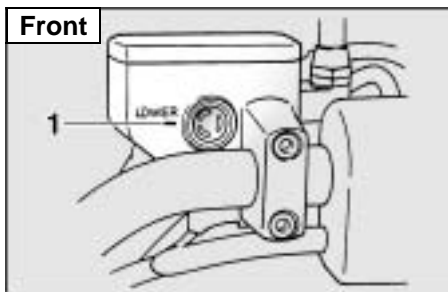

1. Minimum level mark

## Checking the brake fluid level EAU04856

Insufficient brake fluid may allow air to enter the brake system, possibly causing it to become ineffective.

Before riding, check that the brake fluid is above the minimum level mark and replenish if necessary. A low brake fluid level may indicate worn brake pads and/or brake system leakage. If the brake fluid level is low, be sure to check the brake pads for wear and the brake system for leakage.

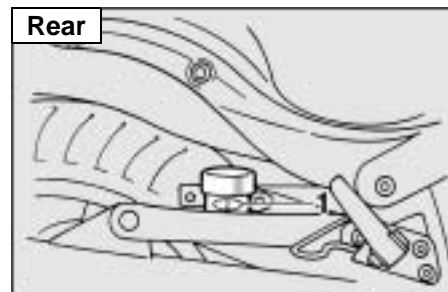

1. Minimum level mark

Observe these precautions:

- When checking the fluid level, make sure that the top of the brake fluid reservoir is level.
- Use only the recommended quality brake fluid, otherwise the rubber seals may deteriorate, causing leakage and poor braking performance.

Recommended brake fluid: DOT 4

- Refill with the same type of brake fluid. Mixing fluids may result in a harmful chemical reaction and lead to poor braking performance.

- Be careful that water does not enter the brake fluid reservoir when refilling. Water will significantly lower the boiling point of the fluid and may result in vapor lock.
- Brake fluid may deteriorate painted surfaces or plastic parts. Always clean up spilled fluid immediately.
- As the brake pads wear, it is normal for the brake fluid level to gradually go down. However, if the brake fluid level goes down suddenly, have a Yamaha dealer check the cause.

EAU03976

## Changing the brake fluid

Have a Yamaha dealer change the brake fluid at the intervals specified in the NOTE after the periodic maintenance and lubrication chart. In addition, have the oil seals of the master cylinders and calipers as well as the brake hoses replaced at the intervals listed below or whenever they are damaged or leaking.

- Oil seals: Replace every two years.
- Brake hoses: Replace every four years.

# PERIODIC MAINTENANCE AND MINOR REPAIR

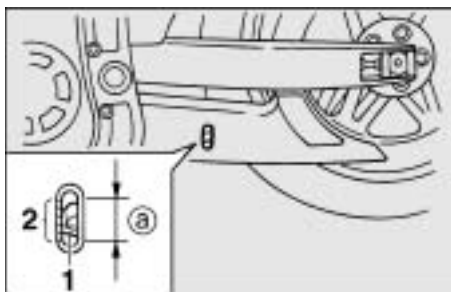

1. Drive belt
2. Marks
- a. Drive belt slack

EAU04451

## Drive belt slack

The drive belt slack should be checked and adjusted at the intervals specified in the periodic maintenance and lubrication chart.

### To check the drive belt slack

1. Place the motorcycle on the side-stand.
2. Note the current position of the drive belt using the marks near the drive belt check hole.

#### NOTE:

The marks near the drive belt check hole are 0.2 in (5 mm) apart.

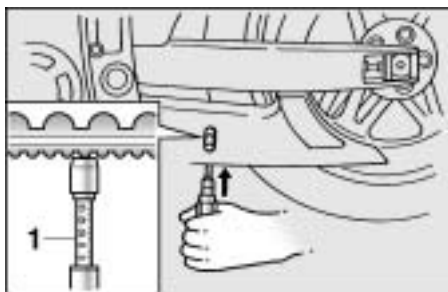

1. Belt tension gauge
3. Note the position of the drive belt with a force of 10 lbf (4.5 kgf, 45 N) applied to the belt with a belt tension gauge as shown.

#### NOTE:

A belt tension gauge is available at a Yamaha dealer.

4. Calculate the drive belt slack by subtracting the measurement noted in step 2 from the measurement noted in step 3.

Drive belt slack:  
0.2–0.3 in (6–8 mm)

5. If the drive belt slack is incorrect, adjust it as follows.

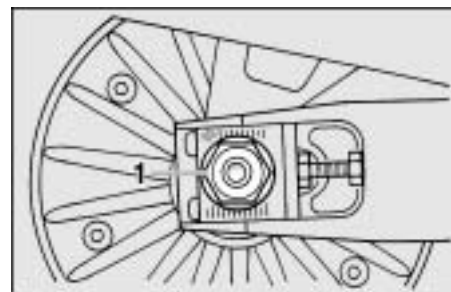

1. Axle nut

EAU04453

### To adjust the drive belt slack

1. Loosen the axle nut and the brake caliper bracket bolt.



# PERIODIC MAINTENANCE AND MINOR REPAIR

ECA00025

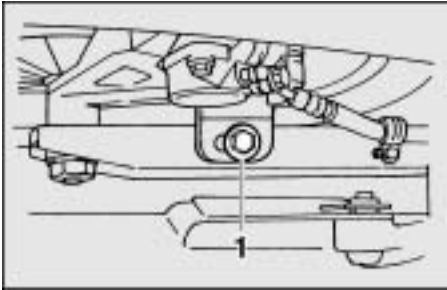

1. Brake caliper bracket bolt

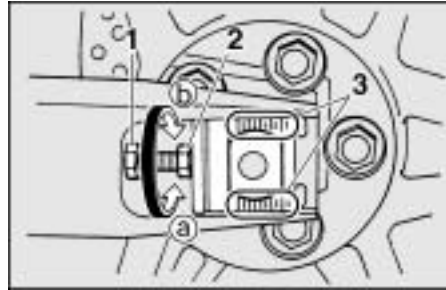

1. Locknut (× 2)
  2. Drive belt slack adjusting bolt (× 2)
  3. Alignment marks
2. Loosen the locknut on each side of the swingarm.
3. To tighten the drive belt, turn the adjusting bolt on each side of the swingarm in direction Ⓐ. To loosen the drive belt, turn the adjusting bolt on each side of the swingarm in direction Ⓑ, and then push the rear wheel forward.

**NOTE:** \_\_\_\_\_  
Using the alignment marks on each side of the swingarm, make sure that both belt pullers are in the same position for proper wheel alignment.

**CAUTION:** \_\_\_\_\_

**Improper drive belt slack will overload the engine. Keep the drive belt slack within the specified range.**

4. Tighten the locknuts, the axle nut and the brake caliper bracket bolt to the specified torques.

**Tightening torques:**

Locknut:

11.6 ft·lbf (1.6 m·kgf, 16 Nm)

Axle nut:

108.5 ft·lbf (15.0 m·kgf, 150 Nm)

Brake caliper bracket bolt:

21.7 ft·lbf (3.0 m·kgf, 30 Nm)

# PERIODIC MAINTENANCE AND MINOR REPAIR

## Checking and lubricating the cables

EAU03297

The operation of all control cables and the condition of the cables should be checked before each ride, and the cables and cable ends should be lubricated if necessary. If a cable is damaged or does not move smoothly, have a Yamaha dealer check or replace it.

Recommended lubricant:

Yamaha Chain and Cable Lube  
or engine oil SAE 10W-30  
(API SE)

EW000111

### WARNING

**Damage to the outer housing of cables may result in internal rusting and cause interference with cable movement. Replace damaged cables as soon as possible to prevent unsafe conditions.**

## Checking and lubricating the throttle grip and cable

EAU04034

The operation of the throttle grip should be checked before each ride. In addition, the cable should be lubricated or replaced at the intervals specified in the periodic maintenance chart.

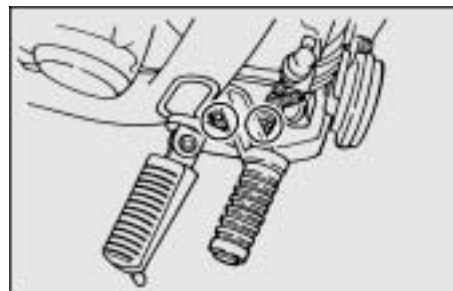

## Checking and lubricating the brake and shift pedals

EAU03370

The operation of the brake and shift pedals should be checked before each ride, and the pedal pivots should be lubricated if necessary.

Recommended lubricant:

Lithium-soap-based grease  
(all-purpose grease)

# PERIODIC MAINTENANCE AND MINOR REPAIR

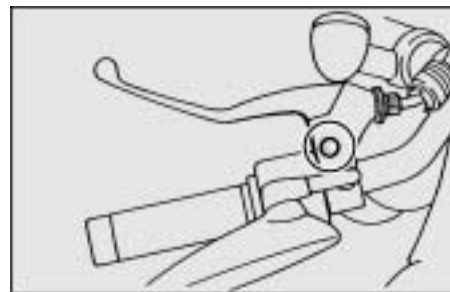
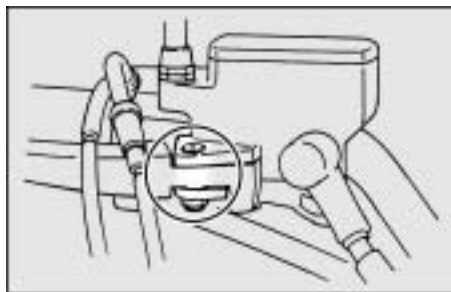
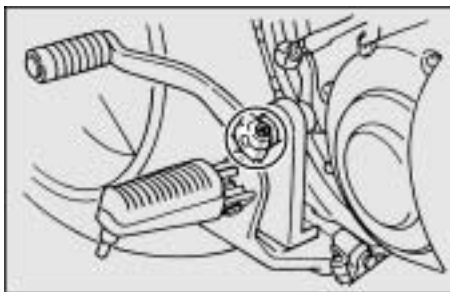

EAU03164

## Checking and lubricating the brake and clutch levers

The operation of the brake and clutch levers should be checked before each ride, and the lever pivots should be lubricated if necessary.

Recommended lubricant:  
Lithium-soap-based grease  
(all-purpose grease)

# PERIODIC MAINTENANCE AND MINOR REPAIR

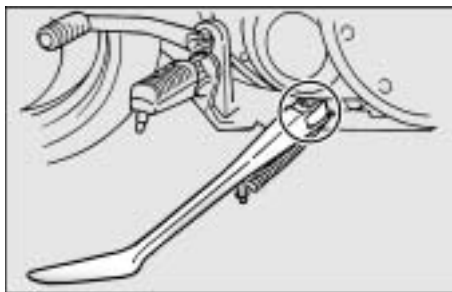

EAU03165

## Checking and lubricating the sidestand

The operation of the sidestand should be checked before each ride, and the sidestand pivot and metal-to-metal contact surfaces should be lubricated if necessary.

EW000113

### **! WARNING**

**If the sidestand does not move up and down smoothly, have a Yamaha dealer check or repair it.**

Recommended lubricant:  
Lithium-soap-based grease  
(all-purpose grease)

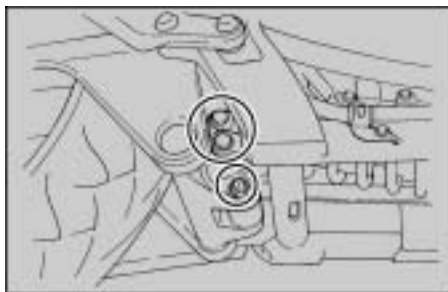

EAU04282

## Lubricating the rear suspension

The pivoting points of the rear suspension must be lubricated at the intervals specified in the periodic maintenance and lubrication chart.

Recommended lubricant:  
Lithium-soap-based grease

EAU02939

## Checking the front fork

The condition and operation of the front fork must be checked as follows at the intervals specified in the periodic maintenance and lubrication chart.

### To check the condition

EW000115

### **! WARNING**

**Securely support the motorcycle so that there is no danger of it falling over.**

Check the inner tubes for scratches, damage and excessive oil leakage.

# PERIODIC MAINTENANCE AND MINOR REPAIR

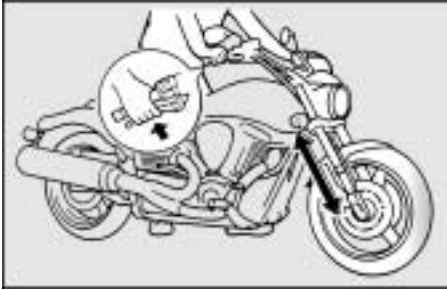

EAU00794

## Checking the steering

Worn or loose steering bearings may cause danger. Therefore, the operation of the steering must be checked as follows at the intervals specified in the periodic maintenance and lubrication chart.

1. Place a stand under the engine to raise the front wheel off the ground.

EW000115

### **⚠ WARNING**

**Securely support the motorcycle so that there is no danger of it falling over.**



2. Hold the lower ends of the front fork legs and try to move them forward and backward. If any free play can be felt, have a Yamaha dealer check or repair the steering.

## To check the operation

1. Place the motorcycle on a level surface and hold it in an upright position.
2. While applying the front brake, push down hard on the handlebars several times to check if the front fork compresses and rebounds smoothly.

EC000098

### **CAUTION:**

**If any damage is found or the front fork does not operate smoothly, have a Yamaha dealer check or repair it.**

# PERIODIC MAINTENANCE AND MINOR REPAIR

EAU01144

## Checking the wheel bearings

The front and rear wheel bearings must be checked at the intervals specified in the periodic maintenance and lubrication chart. If there is play in the wheel hub or if the wheel does not turn smoothly, have a Yamaha dealer check the wheel bearings.

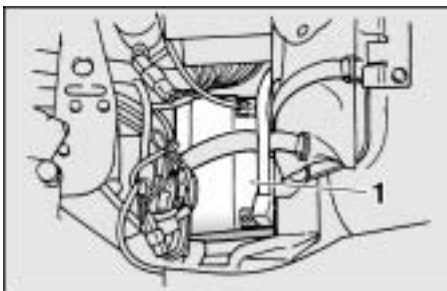

1. Battery

EAU00800

## Battery

This motorcycle is equipped with a sealed-type (MF) battery, which does not require any maintenance. There is no need to check the electrolyte or to add distilled water.

EC000101

### CAUTION:

**Never attempt to remove the battery cell seals, as this would permanently damage the battery.**

EW000116

### ⚠ WARNING

- **Electrolyte is poisonous and dangerous since it contains sulfuric acid, which causes severe burns. Avoid any contact with skin, eyes or clothing and always shield your eyes when working near batteries. In case of contact, administer the following FIRST AID.**
  - **EXTERNAL:** Flush with plenty of water.
  - **INTERNAL:** Drink large quantities of water or milk and immediately call a physician.
  - **EYES:** Flush with water for 15 minutes and seek prompt medical attention.
- **Batteries produce explosive hydrogen gas. Therefore, keep sparks, flames, cigarettes, etc., away from the battery and provide sufficient ventilation when charging it in an enclosed space.**
- **KEEP THIS AND ALL BATTERIES OUT OF THE REACH OF CHILDREN.**

# PERIODIC MAINTENANCE AND MINOR REPAIR

EC000102

## To charge the battery

Have a Yamaha dealer charge the battery as soon as possible if it seems to have discharged. Keep in mind that the battery tends to discharge more quickly if the motorcycle is equipped with optional electrical accessories.

## To store the battery

1. If the motorcycle will not be used for more than one month, remove the battery, fully charge it, and then place it in a cool, dry place.
2. If the battery will be stored for more than two months, check it at least once a month and fully charge it if necessary.
3. Fully charge the battery before installation.
4. After installation, make sure that the battery leads are properly connected to the battery terminals.

### **CAUTION:**

- **Always keep the battery charged. Storing a discharged battery can cause permanent battery damage.**
- **To charge a sealed-type (MF) battery, a special (constant-voltage) battery charger is required. Using a conventional battery charger will damage the battery. If you do not have access to a sealed-type (MF) battery charger, have a Yamaha dealer charge your battery.**

# PERIODIC MAINTENANCE AND MINOR REPAIR

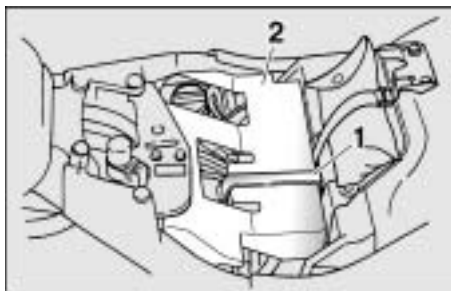

1. Battery band
2. Battery cover

EAU04874

## Replacing the fuses

The main fuse and the fuse box, which contains the fuses for the individual circuits, are located under the seat. (See page 3-11 for seat removal and installation procedures.)

If a fuse is blown, replace it as follows.

1. Unhook the battery band, and then remove the battery cover.

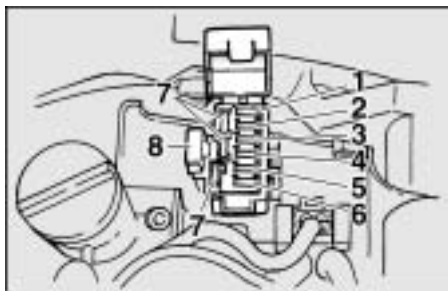

1. Headlight fuse
2. Signaling system fuse
3. Ignition fuse
4. Electronic fuel injection fuse
5. Odometer and clock fuse (backup fuse)
6. Auto-decompression fuse
7. Spare fuse (× 3)
8. ECU fuse

2. Turn the key to "OFF" and turn off the electrical circuit in question.
3. Remove the blown fuse, and then install a new fuse of the specified amperage.

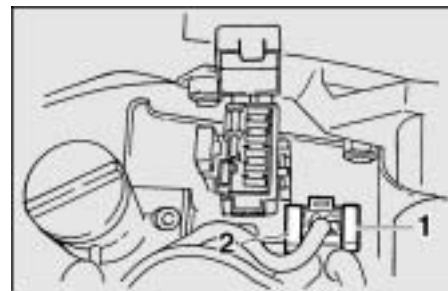

1. Main fuse
2. Spare main fuse

### Specified fuses:

Main fuse:	30 A
Headlight fuse:	15 A
Signaling system fuse:	10 A
Ignition fuse:	10 A
Electronic fuel injection fuse:	15 A
ECU fuse:	10 A
Auto-decompression fuse:	15A
Odometer and clock fuse (backup fuse):	7.5 A



# PERIODIC MAINTENANCE AND MINOR REPAIR

EC000103

## CAUTION:

Do not use a fuse of a higher amperage rating than recommended to avoid causing extensive damage to the electrical system and possibly a fire.

4. Turn the key to "ON" and turn on the electrical circuit in question to check if the device operates.
5. If the fuse immediately blows again, have a Yamaha dealer check the electrical system.
6. Install the battery cover, and then hook the battery band onto the holder.

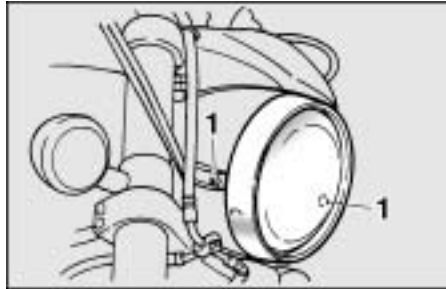

1. Screw (x 2)

EAU04189

## Replacing the headlight bulb

This motorcycle is equipped with a quartz bulb headlight. If the headlight bulb burns out, replace it as follows.

1. Remove the headlight unit by removing the screws.

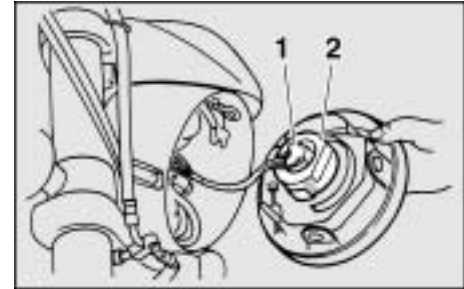

1. Headlight coupler
  2. Headlight bulb cover
2. Disconnect the headlight coupler, and then remove the bulb cover.

# PERIODIC MAINTENANCE AND MINOR REPAIR

EC000105



1. Headlight bulb holder

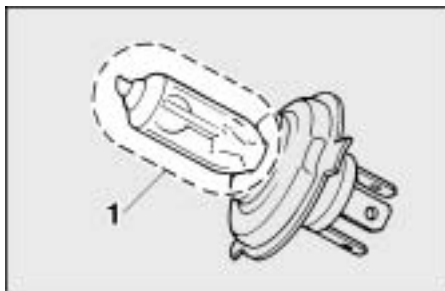

1. Do not touch the glass part of the bulb.

EW000119

## **WARNING**

**Headlight bulbs get very hot. Therefore, keep flammable products away from a lit headlight bulb, and do not touch the bulb until it has cooled down.**

4. Place a new headlight bulb into position, and then secure it with the bulb holder.

## **CAUTION:**

**Do not touch the glass part of the headlight bulb to keep it free from oil, otherwise the transparency of the glass, the luminosity of the bulb, and the bulb life will be adversely affected. Thoroughly clean off any dirt and fingerprints on the headlight bulb using a cloth moistened with alcohol or thinner.**

5. Install the headlight bulb cover, and then connect the coupler.
6. Install the headlight unit by installing the screws.
7. Have a Yamaha dealer adjust the headlight beam if necessary.

# PERIODIC MAINTENANCE AND MINOR REPAIR

## Tail/brake light

EAU03730

This motorcycle is equipped with an LED type of tail/brake light. If the tail/brake light does not come on, have a Yamaha dealer check it.

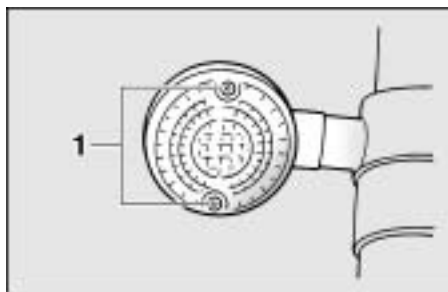

1. Screw (x 2)

## Replacing a turn signal light bulb

EAU03218

1. Remove the turn signal lens by removing the screws.

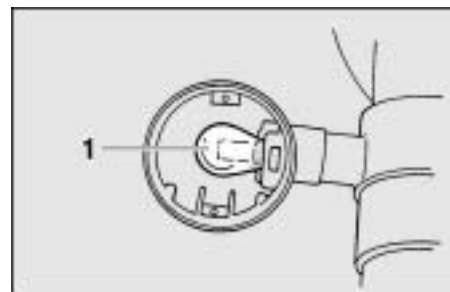

1. Turn signal light bulb
2. Remove the defective bulb by pushing it in and turning it counter-clockwise.
3. Insert a new bulb into the socket, push it in, and then turn it clockwise until it stops.
4. Install the lens by installing the screws.

EC000108

### CAUTION:

**Do not overtighten the screws, otherwise the lens may break.**

# PERIODIC MAINTENANCE AND MINOR REPAIR

ECA00107

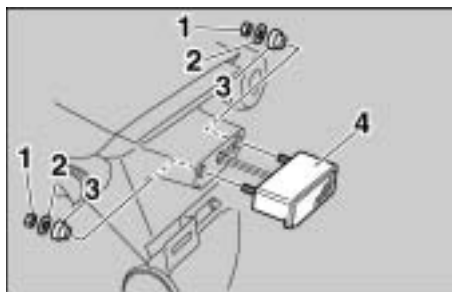

1. Nut (x 2)
2. Washer (x 2)
3. Rubber damper (x 2)
4. Licence plate light unit

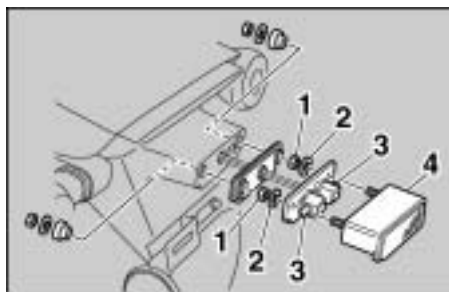

1. Nut (x 2)
2. Washer (x 2)
3. Bulb (x 2)
4. Licence plate light lens

## CAUTION:

Do not overtighten the nuts, otherwise the lens may break.

## 6 Replacing a license plate light bulb

EAU04875

1. Remove the license plate light unit by removing the nuts, washers and rubber dampers.

2. Remove the license plate light lens by removing the nuts and washers.
3. Remove the defective bulb by pulling it out.
4. Insert a new bulb into the socket.
5. Install the license plate light lens by installing the washers and the nuts.
6. Install the license plate light unit by installing the rubber dampers, washers and the nuts.

EAU01579

## Supporting the motorcycle

Since this model is not equipped with a centerstand, follow these precautions when removing the front and rear wheel or performing other maintenance requiring the motorcycle to stand upright. Check that the motorcycle is in a stable and level position before starting any maintenance. A strong wooden box can be placed under the engine for added stability.

### To service the front wheel

1. Stabilize the rear of the motorcycle by using a motorcycle stand or, if an additional motorcycle stand is not available, by placing a jack under the frame in front of the rear wheel.
2. Raise the front wheel off the ground by using a motorcycle stand.

### To service the rear wheel

Raise the rear wheel off the ground by using a motorcycle stand or, if a motorcycle stand is not available, by placing a jack either under each side of the frame in front of the rear wheel or under each side of the swingarm.

EAU01008

## Troubleshooting

Although Yamaha motorcycles receive a thorough inspection before shipment from the factory, trouble may occur during operation. Any problem in the fuel, compression, or ignition systems, for example, can cause poor starting and loss of power.

The following troubleshooting chart represents a quick and easy procedure for checking these vital systems yourself. However, should your motorcycle require any repair, take it to a Yamaha dealer, whose skilled technicians have the necessary tools, experience, and know-how to service the motorcycle properly.

Use only genuine Yamaha replacement parts. Imitation parts may look like Yamaha parts, but they are often inferior, have a shorter service life and can lead to expensive repair bills.

# PERIODIC MAINTENANCE AND MINOR REPAIR

## Troubleshooting chart

EAU01297

EW000125



**WARNING**

**Keep away open flames and do not smoke while checking or working on the fuel system.**

### 1. Fuel

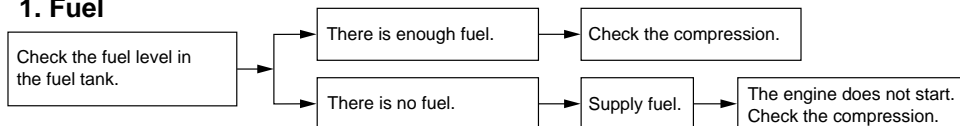

### 2. Compression

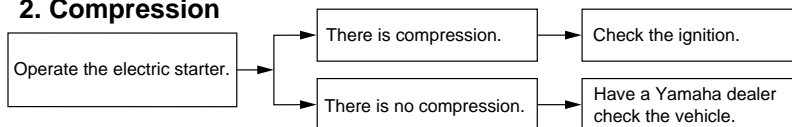

### 3. Ignition

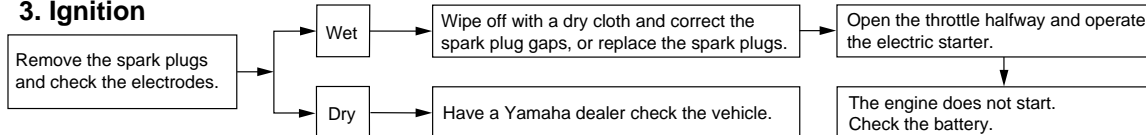

### 4. Battery

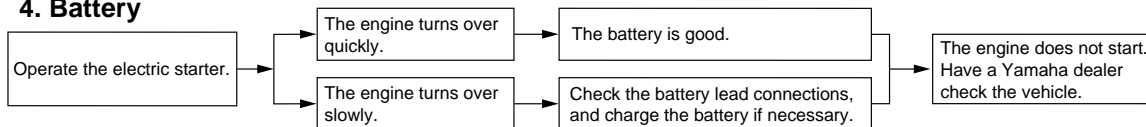

# MOTORCYCLE CARE AND STORAGE

---

Care ..... 7-1  
Storage ..... 7-4

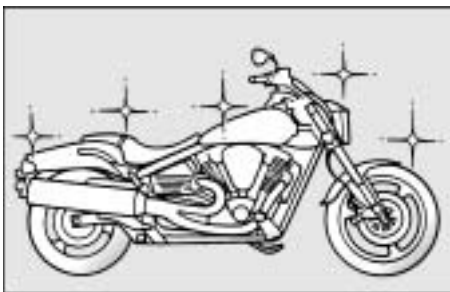

## Care

While the open design of a motorcycle reveals the attractiveness of the technology, it also makes it more vulnerable. Rust and corrosion can develop even if high-quality components are used. A rusty exhaust pipe may go unnoticed on a car, however, it detracts from the overall appearance of a motorcycle. Frequent and proper care does not only comply with the terms of the warranty, but it will also keep your motorcycle looking good, extend its life and optimize its performance.

## Before cleaning

1. Cover the muffler outlet with a plastic bag after the engine has cooled down.
2. Make sure that all caps and covers as well as all electrical couplers and connectors, including the spark plug caps, are tightly installed.
3. Remove extremely stubborn dirt, like oil burnt onto the crankcase, with a degreasing agent and a brush, but never apply such products onto seals, gaskets, the drive belt and wheel axles. Always rinse the dirt and degreaser off with water.

## Cleaning

ECA00010

### CAUTION:

- **Avoid using strong acidic wheel cleaners, especially on spoked wheels. If such products are used on hard-to-remove dirt, do not leave the cleaner on the affected area any longer than instructed. Also, thoroughly rinse the area off with water, immediately dry it, and then apply a corrosion protection spray.**
- **Improper cleaning can damage windshields, cowlings, panels and other plastic parts. Use only a soft, clean cloth or sponge with mild detergent and water to clean plastic.**
- **Do not use any harsh chemical products on plastic parts. Be sure to avoid using cloths or sponges which have been in contact with strong or abrasive cleaning products, solvent or**



# MOTORCYCLE CARE AND STORAGE

---

thinner, fuel (gasoline), rust removers or inhibitors, brake fluid, antifreeze or electrolyte.

- Do not use high-pressure washers or steam-jet cleaners since they cause water seepage and deterioration in the following areas: seals (of wheel and swing-arm bearings, fork and brakes), electric components (couplers, connectors, instruments, switches and lights), breather hoses and vents.
- For motorcycles equipped with a windshield: Do not use strong cleaners or hard sponges as they will cause dulling or scratching. Some cleaning compounds for plastic may leave scratches on the windshield. Test the product on a small hidden part of the windshield to make sure that it does not leave any marks. If the wind-

**shield is scratched, use a quality plastic polishing compound after washing.**

---

## After normal use

Remove dirt with warm water, a mild detergent, and a soft, clean sponge, and then rinse thoroughly with clean water. Use a toothbrush or bottlebrush for hard-to-reach areas. Stubborn dirt and insects will come off more easily if the area is covered with a wet cloth for a few minutes before cleaning.

## After riding in the rain, near the sea or on salt-sprayed roads

Since sea salt or salt sprayed on roads during winter are extremely corrosive in combination with water, carry out the following steps after each ride in the rain, near the sea or on salt-sprayed roads.

## **NOTE:** \_\_\_\_\_

Salt sprayed on roads in the winter may remain well into spring.

---

1. Clean the motorcycle with cold water and a mild detergent, after the engine has cooled down.

ECA00012

## **CAUTION:** \_\_\_\_\_

**Do not use warm water since it increases the corrosive action of the salt.**

---

2. After drying the motorcycle, apply a corrosion protection spray on all metal, including chrome- and nickel-plated, surfaces to prevent corrosion.

# MOTORCYCLE CARE AND STORAGE

---

## After cleaning

1. Dry the motorcycle with a chamois or an absorbing cloth.
2. Use a chrome polish to shine chrome, aluminum and stainless-steel parts, including the exhaust system. (Even the thermally induced discoloring of stainless-steel exhaust systems can be removed through polishing.)
3. To prevent corrosion, it is recommended to apply a corrosion protection spray on all metal, including chrome- and nickel-plated, surfaces.
4. Use spray oil as a universal cleaner to remove any remaining dirt.
5. Touch up minor paint damage caused by stones, etc.
6. Wax all painted and chrome-plated surfaces. Avoid combination cleaner waxes, many of which contain abrasives that may mar the paint or protective finish.
7. Let the motorcycle dry completely before storing or covering it.

EWA00001

### **WARNING**

- **Make sure that there is no oil or wax on the brakes or tires. If necessary, clean the brake discs and brake linings with a regular brake disc cleaner or acetone, and wash the tires with warm water and a mild detergent.**
  - **Before operating the motorcycle, test its braking performance and cornering behavior.**
- 

ECA00033

### **CAUTION:**

- **Apply spray oil and wax sparingly and make sure to wipe off any excess.**
  - **Never apply oil or wax to the drive belt.**
  - **Never apply oil or wax to any rubber and plastic parts, but treat them with a suitable care product.**
  - **Avoid using abrasive polishing compounds as they will wear away the paint.**
- 

### **NOTE:**

Consult a Yamaha dealer for advice on what products to use.

---

# MOTORCYCLE CARE AND STORAGE

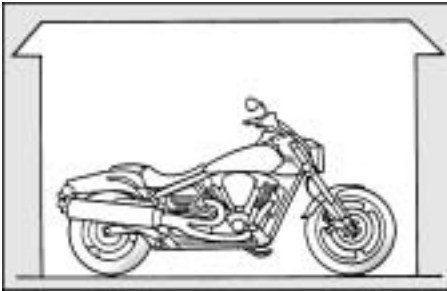

## Storage

### Short-term

Always store your motorcycle in a cool, dry place and, if necessary, protect it against dust with a porous cover.

ECA00014

### CAUTION:

- Storing the motorcycle in a poorly ventilated room or covering it with a tarp, while it is still wet, will allow water and humidity to seep in and cause rust.
- To prevent corrosion, avoid damp cellars, stables (because of the presence of ammonia) and areas where strong chemicals are stored.

### Long-term

Before storing your motorcycle for several months:

1. Follow all the instructions in the “Care” section of this chapter.
2. Fill up the fuel tank and add fuel stabilizer (if available) to prevent the fuel tank from rusting and the fuel from deteriorating.
3. Perform the following steps to protect the cylinders, piston rings, etc. from corrosion.

- a. Remove the spark plug caps and spark plugs.
- b. Pour a teaspoonful of engine oil into each spark plug bore.
- c. Install the spark plug caps onto the spark plugs, and then place the spark plugs on the cylinder head so that the electrodes are grounded. (This will limit sparking during the next step.)
- d. Turn the engine over several times with the starter. (This will coat the cylinder walls with oil.)
- e. Remove the spark plug caps from the spark plugs, and then install the spark plugs and the spark plug caps.

EWA00003

### WARNING

To prevent damage or injury from sparking, make sure to ground the spark plug electrodes while turning the engine over.

# MOTORCYCLE CARE AND STORAGE

---

4. Lubricate all control cables and the pivoting points of all levers and pedals as well as of the sidestand/centerstand.
5. Check and, if necessary, correct the tire air pressure, and then lift the motorcycle so that both of its wheels are off the ground. Alternatively, turn the wheels a little every month in order to prevent the tires from becoming degraded in one spot.
6. Cover the muffler outlet with a plastic bag to prevent moisture from entering it.
7. Remove the battery and fully charge it. Store it in a cool, dry place and charge it once a month. Do not store the battery in an excessively cold or warm place [less than 30 °F (0 °C) or more than 90 °F (30 °C)]. For more information on storing the battery, see page 6-36.

**NOTE:** \_\_\_\_\_  
Make any necessary repairs before  
storing the motorcycle.  
\_\_\_\_\_

Specifications ..... 8-1

## Specifications

<b>Model</b>	<b>XV1700PC(C)</b>
<b>Dimensions</b>	
Overall length	93.9 in (2,385 mm)
Overall width	37.6 in (955 mm)
Overall height	44.1 in (1,120 mm)
Seat height	28.5 in (725 mm)
Wheelbase	65.6 in (1,665 mm)
Ground clearance	6.1 in (155 mm)
Minimum turning radius	133.9 in (3,400 mm)
<b>Basic weight (with oil and full fuel tank)</b>	<b>650 lb (295 kg)</b>
<b>Engine</b>	
Engine type	Air-cooled 4-stroke, OHV
Cylinder arrangement	V-type 2-cylinder
Displacement	1,670 cm <sup>3</sup>
Bore × Stroke	3.82 × 4.45 in (97 × 113 mm)
Compression ratio	8.36:1
Starting system	Electric starter
Lubrication system	Dry sump

## Engine oil

Type	YAMALUBE 4 (20W-40) or SAE 20W-40
Recommended engine oil classification	API Service SE, SF, SG or higher

### CAUTION:

**In order to prevent clutch slippage (since the engine oil also lubricates the clutch), do not mix any chemical additives. Do not use oils with a diesel specification of “CD” or oils of a higher quality than specified. In addition, do not use oils labeled “ENERGY CONSERVING II” or higher.**

## Quantity

Without oil filter cartridge replacement	3.9 US qt (3.3 Imp qt, 3.7 L)
With oil filter cartridge replacement	4.3 US qt (3.6 Imp qt, 4.1 L)
Total amount (dry engine)	5.3 US qt (4.4 Imp qt, 5.0 L)

# SPECIFICATIONS

## Transfer case oil

Type	SAE80 API "GL-4" hypoid gear oil
Quantity	0.42 US qt (0.35 Imp qt, 0.4 L)

## Air filters

Oil-coated paper element

## Fuel

Type	UNLEADED GASOLINE ONLY
Fuel tank capacity	4.0 US gal (3.3 Imp gal, 15.0 L)
Amount remaining when the fuel level warning light comes on	0.8 US gal (0.7 Imp gal, 3.0 L)

## Electronic fuel injection

Model	INP-732/2
Manufacturer	NIPPON INJECTOR

## Spark plug

Manufacturer/model	NGK / DPR7EA-9 or DENSO / X22EPR-U9
Gap	0.03–0.04 in (0.8–0.9 mm)

## Clutch type

Wet, multiple-disc

## Transmission

Primary reduction system	Spur gear
Primary reduction ratio	1.532
Secondary reduction system	Belt drive
Secondary reduction ratio	2.393
Transmission type	Constant mesh 5-speed

## Operation

Left foot

## Gear ratio

1st	2.375
2nd	1.579
3rd	1.160
4th	0.935
5th	0.800

## Chassis

Frame type	Double cradle
Caster angle	29.25°
Trail	5.12 in (130 mm)

## Tire

### Front

Type	Tubeless tire
Size	120/70 ZR18 (59W) 120/70 ZR18 M/C (59W)
Manufacturer/ model	Dunlop / D220F ST G Bridgestone / BT020F G

### Rear

Type	Tubeless tire
Size	200/50 ZR17 (75W) 200/50 ZR17 M/C (75W)

# SPECIFICATIONS

Manufacturer/ model	Dunlop / D220 ST Bridgestone / BT020R
Maximum load*	408 lb (185 kg)
Tire air pressure (measured on cold tires)	
Up to 198 lb (90 kg)*	
Front	36 psi (2.50 kgf/cm <sup>2</sup> , 250 kPa)
Rear	36 psi (2.50 kgf/cm <sup>2</sup> , 250 kPa)
198 lb (90 kg)—maximum*	
Front	36 psi (2.50 kgf/cm <sup>2</sup> , 250 kPa)
Rear	42 psi (2.90 kgf/cm <sup>2</sup> , 290 kPa)
High-speed riding	
Front	36 psi (2.50 kgf/cm <sup>2</sup> , 250 kPa)
Rear	36 psi (2.50 kgf/cm <sup>2</sup> , 250 kPa)

\* Total weight of rider, passenger, cargo and accessories

## Wheels

Front	
Type	Cast wheel
Size	18 × MT 3.50 18 M/C × MT 3.50
Rear	
Type	Cast wheel
Size	17 × MT 6.00 17 M/C × MT 6.00

## Brakes

Front	
Type	Dual disc brake
Operation	Right hand
Fluid	DOT 4
Rear	
Type	Single disc brake
Operation	Right foot
Fluid	DOT 4

## Suspension

Front	Telescopic fork
Rear	Swingarm (link suspension)

## Spring/Shock absorber

Front	Coil spring / oil damper
Rear	Coil spring / gas-oil damper

## Wheel travel

Front	5.3 in (135 mm)
Rear	4.3 in (110 mm)

## Electrical

Ignition system	T.C.I. (digital)
Charging system	
Type	A.C. magneto
Standard output	14 V, 31 A @ 5,000 r/min



Battery	
Model	GT14B-4
Voltage, capacity	12 V, 12 Ah
<b>Headlight type</b>	Halogen bulb
<b>Bulb voltage, wattage × quantity</b>	
Headlight	12 V, 60/55 W × 1
Tail/brake light	LED
License plate light	12 V, 5 W × 2
Front turn signal/ position light	12 V, 23/8 W × 2
Rear turn signal light	12 V, 23 W × 2
Meter lighting	LED
Neutral indicator light	LED
High beam indicator light	LED
Turn signal indicator light	LED × 2
Fuel level warning light	LED
Engine trouble warning light	LED
<b>Fuses</b>	
Main fuse	30 A
Ignition fuse	10 A
Signaling system fuse	10 A
Headlight fuse	15 A
Electronic fuel injection fuse	15 A
ECU fuse	10 A

Auto-decompression fuse	15 A
Odometer and clock fuse (backup fuse)	7.5 A



Identification numbers .....	9-1
Key identification number .....	9-1
Vehicle identification number .....	9-1
Model label .....	9-2
Reporting safety defects .....	9-3
Motorcycle noise regulation .....	9-4
Maintenance record .....	9-5
YAMAHA MOTOR CORPORATION, U.S.A. STREET AND ENDURO MOTORCYCLE LIMITED WARRANTY .....	9-7
YAMAHA EXTENDED SERVICE (Y.E.S.) .....	9-9

## Identification numbers

EAU02944

Record the key identification number, vehicle identification number and model label information in the spaces provided below for assistance when ordering spare parts from a Yamaha dealer or for reference in case the vehicle is stolen.

### 1. KEY IDENTIFICATION NUMBER:

### 2. VEHICLE IDENTIFICATION NUMBER:

### 3. MODEL LABEL INFORMATION:

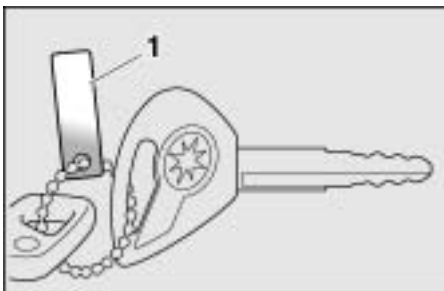
1. Key identification number

EAU01041

## Key identification number

The key identification number is stamped into the key tag. Record this number in the space provided and use it for reference when ordering a new key.



1. Vehicle identification number

EAU01043

## Vehicle identification number

The vehicle identification number is stamped into the steering head pipe. Record this number in the space provided.

### NOTE: \_\_\_\_\_

The vehicle identification number is used to identify your motorcycle and may be used to register your motorcycle with the licensing authority in your area.

---

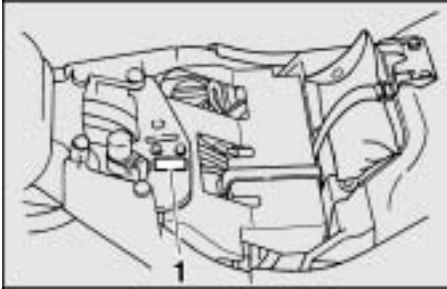

1. Model label

EAU01050

## Model label

The model label is affixed to the frame under the seat. (See page 3-11 for seat removal and installation procedures.) Record the information on this label in the space provided. This information will be needed when ordering spare parts from a Yamaha dealer.

# CONSUMER INFORMATION

---

EAU01051

## Reporting safety defects

If you believe that your vehicle has a defect which could cause a crash or could cause injury or death, you should immediately inform the National Highway Traffic Safety Administration (NHTSA) in addition to notifying Yamaha Motor Corporation, U.S.A. If NHTSA receives similar complaints, it may open an investigation, and if it finds that a safety defect exists in a group of vehicles, it may order a recall and remedy campaign. However, NHTSA cannot become involved in individual problems between you, your dealer, or Yamaha Motor Corporation, U.S.A.

To contact NHTSA, you may either call the Auto Safety Hotline toll-free at 1-800-424-9393 (or 366-0123 in Washington, D.C. area) or write to: NHTSA, U.S. Department of Transportation, Washington, D.C. 20590. You can also obtain other information about motor vehicle safety from the Hotline.

## Motorcycle noise regulation

### TAMPERING WITH NOISE CONTROL SYSTEM PROHIBITED:

Federal law prohibits the following acts or the causing thereof: (1) The removal or rendering inoperative by any person other than for purposes of maintenance, repair, or replacement of any device or element of design incorporated into any new vehicle for the purpose of noise control prior to its sale or delivery to the ultimate purchaser or while it is in use or (2) the use of the vehicle after such device or element of design has been removed or rendered inoperative by any person.

“AMONG THOSE ACTS PRESUMED TO CONSTITUTE TAMPERING ARE THE ACTS LISTED BELOW”.

These acts include tampering with the following systems; i.e., modification, removal, etc.

Exhaust system	Muffler Exhaust pipe Silencer
Intake system	Air cleaner case Air cleaner element Intake duct

# CONSUMER INFORMATION

EAU01325

## Maintenance record

Copies of work orders and/or receipts for parts purchased and installed on your motorcycle will be required to document that maintenance has been completed in accordance with the emissions warranty. The chart below is printed only as a reminder that maintenance work is required. It is not acceptable proof of maintenance work.

Maintenance interval	Date of service	Mileage	Servicing dealer name and address	Remarks
600 mi (1,000 km) or 1 month				
4,000 mi ( 7,000 km) or 6 months				
8,000 mi (13,000 km) or 12 months				
12,000 mi (19,000 km) or 18 months				
16,000 mi (25,000 km) or 24 months				
20,000 mi (31,000 km) or 30 months				
24,000 mi (37,000 km) or 36 months				



# CONSUMER INFORMATION

<b>Maintenance interval</b>	<b>Date of service</b>	<b>Mileage</b>	<b>Servicing dealer name and address</b>	<b>Remarks</b>
28,000 mi (43,000 km) or 42 months				
32,000 mi (49,000 km) or 48 months				
36,000 mi (55,000 km) or 54 months				
40,000 mi (61,000 km) or 60 months				

# CONSUMER INFORMATION

EAU02918

## YAMAHA MOTOR CORPORATION, U.S.A. STREET AND ENDURO MOTORCYCLE LIMITED WARRANTY

Yamaha Motor Corporation, U.S.A. hereby warrants each new model Yamaha motorcycle will be free from defects in material and workmanship for the period of time stated herein, subject to certain stated limitations.

**THE PERIOD OF WARRANTY** for Yamaha motorcycles originally equipped with headlight, stoplight, and turn signals shall be one (1) year from the date of purchase, with no mileage limitation.

**MODELS EXCLUDED FROM WARRANTY** include those used for non-Yamaha-authorized renting, leasing, or other commercial purposes, and TZ models.

**DURING THE PERIOD OF WARRANTY** any authorized Yamaha motorcycle dealer will, free of charge, repair or replace any part adjudged defective by Yamaha due to faulty workmanship or material from the factory. Parts used in warranty repairs will be warranted for the balance of the product's warranty period. All parts replaced under warranty become property of Yamaha Motor Corp. U.S.A.

**GENERAL EXCLUSIONS** from this warranty shall include any failures caused by:

- Competition or racing use.
- Installation of parts or accessories that are not qualitatively equivalent to genuine Yamaha parts.
- Abnormal strain, neglect, or abuse.
- Lack of proper maintenance.
- Accident or collision damage.
- Modification to original parts.

**SPECIFIC EXCLUSIONS** from this warranty shall include parts replaced due to normal wear or routine maintenance.

**THE CUSTOMER'S RESPONSIBILITY** under this warranty shall be to:

- Operate and maintain the motorcycle as specified in the appropriate Owner's Manual, and
- Give notice to an authorized Yamaha motorcycle dealer of any and all apparent defects within ten (10) days after discovery, and make the machine available at that time for inspection and repairs at such dealer's place of business.

**WARRANTY TRANSFER:** To transfer the warranty from the original purchaser to any subsequent purchaser, it is imperative that the machine be inspected and registered for warranty by an authorized Yamaha motorcycle dealer. In order for this warranty to remain in effect, this inspection and registration must take place within ten (10) days after transfer. An inspection and registration fee will be charged for this service.

### EMISSIONS CONTROL SYSTEM WARRANTY

Yamaha Motor Corporation, U.S.A. also warrants to the ultimate purchaser and each subsequent purchaser of each Yamaha motorcycle covered by this warranty with a displacement of 50cc or greater, that the vehicle is designed, built, and equipped so as to conform at the time of sale with all U.S. emissions standards applicable at the time of manufacture and that it is free from defects in materials and workmanship which would cause it not to meet these standards within the periods listed immediately below. Failure other than those resulting from defects in material or workmanship which arise solely as a result of owner abuse and / or lack of proper maintenance are not covered by this warranty.

ENGINE DISPLACEMENT	PERIOD
50cc to 169cc	12,000 km (7,465 miles) or five years, whichever occurs first
170cc to 279cc	18,000 km (11,185 miles) or five years, whichever occurs first
280cc or over	30,000 km (18,641 miles) or five years, whichever occurs first

**YAMAHA MOTOR CORPORATION, U.S.A. MAKES NO OTHER WARRANTY OF ANY KIND, EXPRESSED OR IMPLIED. ALL IMPLIED WARRANTIES OF MERCHANTABILITY AND FITNESS FOR A PARTICULAR PURPOSE WHICH EXCEED THE OBLIGATIONS AND TIME LIMITS STATED IN THIS WARRANTY ARE HEREBY DISCLAIMED BY YAMAHA MOTOR CORPORATION, U.S.A. AND EXCLUDED FROM THIS WARRANTY.**

**SOME STATES DO NOT ALLOW LIMITATIONS ON HOW LONG AN IMPLIED WARRANTY LASTS, SO THE ABOVE LIMITATION MAY NOT APPLY TO YOU. ALSO EXCLUDED FROM THIS WARRANTY ARE ANY INCIDENTAL OR CONSEQUENTIAL DAMAGES INCLUDING LOSS OF USE. SOME STATES DO NOT ALLOW THE EXCLUSION OR LIMITATION OF INCIDENTAL OR CONSEQUENTIAL DAMAGES, SO THE ABOVE EXCLUSION MAY NOT APPLY TO YOU.**

**THIS WARRANTY GIVES YOU SPECIFIC LEGAL RIGHTS, AND YOU MAY ALSO HAVE OTHER RIGHTS WHICH VARY FROM STATE TO STATE.**

YAMAHA MOTOR CORPORATION, U.S.A.  
P.O. Box 6555  
Cypress, California 90630

## WARRANTY QUESTIONS AND ANSWERS

- Q. What costs are my responsibility during the warranty period?
- A. The customer's responsibility includes all costs of normal maintenance services, non-warranty repairs, accident and collision damages, and oil, oil filters, air filters, spark plugs, and brake shoes.
- Q. What are some examples of "abnormal" strain, neglect, or abuse?
- A. These terms are general and overlap each other in areas. Specific examples include: Running the machine out of oil, sustained high-rpm, full-throttle, operating the machine with a broken or damaged part which causes another part to fail, damage or failure due to improper or careless transportation and or tie down. If you have any specific questions on operation or maintenance, please contact your dealer for advice.
- Q. Does the warranty cover incidental costs such as towing or transportation due to a failure?
- A. No. The warranty is limited to repair of the machine itself.
- Q. May I perform any or all of the recommended maintenance shown in the Owner's Manual instead of having the dealer do them?
- A. Yes, if you are a qualified mechanic and follow the procedures specified in the Owner's and Service Manual. We do recommend, however, that items requiring special tools or equipment be done by Yamaha Motorcycle dealer.
- Q. Will the warranty be void or cancelled if I do not operate or maintain my new motorcycle exactly as specified in the Owner's Manual?
- A. No. The warranty on a new motorcycle cannot be "voided" or "cancelled." **However, if a particular failure is caused by operation or maintenance other than as shown in the Owner's Manual, that failure may not be covered under warranty.**
- Q. What responsibility does my dealer have under this warranty?
- A. Each Yamaha Motorcycle dealer is expected to:
1. Completely set up every new machine before sale.
  2. Explain the operation, maintenance, and warranty requirements to your satisfaction at the time of sale, and upon your request at any later date.
  3. Each Yamaha Motorcycle dealer is held responsible for his setup, service and warranty repair work.
- Q. Is the warranty transferable to second owners?
- A. Yes. The remainder of the existing warranty can be transferred upon request. The unit has to be inspected and re-registered by an authorized Yamaha Motorcycle dealer for the policy to remain effective.

## CUSTOMER SERVICE

If your machine requires warranty service, you must take it to any authorized Yamaha Motorcycle dealer within the continental United States. Be sure to bring your warranty registration card or other valid proof of the original date of purchase. If a question or problem arises regarding warranty, first contact the owner of the dealership. Since all warranty matters are handled at the dealer level, this person is in the best position to help you. If you are still not satisfied and require additional assistance, please write:

YAMAHA MOTOR CORPORATION U.S.A.  
CUSTOMER RELATIONS DEPARTMENT  
P.O. Box 6555  
Cypress, California 90630

When contacting Yamaha Motor Corporation, U.S.A. don't forget to include any important information such as names, addresses, model, V.I.N. (frame number), dates, and receipts.

## CHANGE OF ADDRESS

The federal government requires each manufacturer of a motor vehicle to maintain a complete, up-to-date list of all first purchasers against the possibility of a safety-related defect and recall. This list is compiled from the purchase registrations sent to Yamaha Motor Corporation, U.S.A. by the selling dealer at the time of your purchase.

If you should move after you have purchased your new motorcycle, please advise us of your new address by sending a postcard listing your motorcycle model name, V.I.N. (frame number), dealer number (or dealer's name) as it is shown on your warranty card, your name and new mailing address. Mail to:

YAMAHA MOTOR CORPORATION, U.S.A.  
P.O. Box 6555  
Cypress, California 90630  
Attention: Warranty Department

This will ensure that Yamaha Motor Corporation, U.S.A. has an up-to-date registration record in accordance with federal law.

## YAMAHA EXTENDED SERVICE (Y.E.S.)

Keep your Yamaha protected even after your warranty expires with genuine Yamaha Extended Service (Y.E.S.).

- Y.E.S. is designed and administered by Yamaha Motor Corporation to provide maximum owner satisfaction. You get uninterrupted factory-backed coverage for extra peace of mind.
- Y.E.S. is flexible. You choose the plan that's right for you: 12 months, 24 months, or 36 months beyond your warranty period.
- Y.E.S. is designed and administered by the same Yamaha people who handle your warranty – and it shows in the comprehensive coverage benefits. There are no mileage limitations. Coverage isn't limited to "moving parts" or the "drive train" like many other plans. And Y.E.S. covers manufacturing defects just like the warranty. See the sample contract at your Yamaha dealer to see how comforting uninterrupted factory-backed protection can be.
- You don't have to pay anything for covered repairs. There's no deductible to pay, and repairs aren't "pro-rated." You don't have any "out-of-pocket" expenses for covered repairs.
- In addition, Travel and Recreation Interruption Protection (TRIP) is included at no extra cost. TRIP gives you up to \$150 reimbursement per occurrence for any reasonable expenses you incur because your Yamaha needs covered service: replacement vehicle rental, emergency towing, phone calls, even food and lodging when you are away from home. This superb coverage goes into effect when you purchase Y.E.S., so it applies to any warranty repairs as well as covered repairs during your entire Y.E.S. plan period.
- Y.E.S. coverage is honored at any authorized Yamaha dealer nationwide.
- Y.E.S. coverage is transferable to a new owner if you sell or trade-in. That can make your Yamaha much more valuable!

This excellent Y.E.S. plan coverage is only available to Yamaha owners like you, and only while your Yamaha is still within the Yamaha Limited Warranty period. So visit your authorized Yamaha dealer to get all the facts. He can show you how easy it is to protect your investment with Yamaha Extended Service.

We urge you to act now. You'll get the excellent benefits of TRIP coverage right away, and you'll rest easy knowing you'll have strong factory-backed protection even after your Yamaha Limited Warranty expires. You can also save money: Y.E.S. costs less within the first 90 days after you buy your Yamaha. See your dealer today!

A special note:

If visiting your dealer isn't convenient, contact Yamaha with your Primary ID number (your frame number). We'll be happy to help you get the Y.E.S. coverage you need.

Yamaha Service Marketing  
P.O. Box 6555  
Cypress, CA 90630



**YAMAHA**



**EXTENDED**

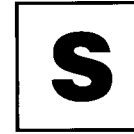

**SERVICE**

# INDEX

## A

- Accessories and replacement parts ..... 6-23
- Air filter elements, replacing ..... 6-13

## B

- Battery ..... 6-35
- Brake and clutch levers, checking and lubricating ..... 6-32
- Brake and shift pedals, checking and lubricating ..... 6-31
- Brake fluid, changing ..... 6-28
- Brake fluid level, checking ..... 6-27
- Brake lever ..... 3-8
- Brake lever free play, adjusting ..... 6-24
- Brake light switch (rear), adjusting ..... 6-25
- Brake pads, checking ..... 6-26
- Brake pedal ..... 3-8
- Brake pedal position, adjusting ..... 6-25

## C

- Cables, checking and lubricating ..... 6-31
- Canister (for California only) ..... 6-8
- Care ..... 7-1
- Clutch lever ..... 3-7
- Clutch lever free play, adjusting ..... 6-23

## D

- Dimmer switch ..... 3-6
- Drive belt slack ..... 6-29
  - Adjusting ..... 6-29
  - Checking ..... 6-29

## E

- Engine break-in ..... 5-5
- Engine oil and oil filter cartridge ..... 6-9
- Engine stop switch ..... 3-7
- Engine trouble warning light ..... 3-3

## F

- Front fork, adjusting ..... 3-12
- Front fork, checking ..... 6-33
- Fuel ..... 3-9
- Fuel level warning light ..... 3-2
- Fuel tank cap ..... 3-9
- Fuses, replacing ..... 6-37

## H

- Handlebar switches ..... 3-6
- Headlight bulb, replacing ..... 6-38
- Helmet holder ..... 3-11
- High beam indicator light ..... 3-2
- Horn switch ..... 3-6

## I

- Identification numbers ..... 9-1
- Ignition circuit cut-off system ..... 3-16
- Indicator and warning lights ..... 3-2

## K

- Key identification number ..... 9-1

## L

- Labels, location ..... 1-7
- License plate light bulb, replacing ..... 6-41

## M

- Main switch/steering lock ..... 3-1
- Maintenance and lubrication, periodic ..... 6-4
- Maintenance, emission control system ..... 6-3
- Maintenance, periodic ..... 6-1
- Maintenance record ..... 9-5
- Model label ..... 9-2

## N

- Neutral indicator light ..... 3-3
- Noise regulation ..... 9-4

## P

- Parking ..... 5-5
- Part locations ..... 2-1
- Pre-operation check list ..... 4-1

## R

- Rear suspension, lubricating ..... 6-33

## S

- Safety defects, reporting ..... 9-3
- Safety information ..... 1-1
- Seat ..... 3-11
- Shifting ..... 5-3
  - Decelerating ..... 5-4
  - Shift points ..... 5-4
  - Starting out and accelerating ..... 5-3
- Shift pedal ..... 3-7
- Shock absorber assembly, adjusting ..... 3-13
- Sidestand ..... 3-15
- Sidestand, checking and lubricating ..... 6-33

Spark plugs, checking .....	6-7
Specifications .....	8-1
Speedometer .....	3-3
Starting and warming up a cold engine ....	5-1
Start switch.....	3-7
Steering, checking .....	6-34
Storage.....	7-4
Supporting the motorcycle .....	6-42

## T

Tachometer unit .....	3-4
Tail/brake light .....	6-40
Throttle cable free play, adjusting .....	6-18
Throttle grip and cable, checking and lubricating.....	6-31
Tires .....	6-19
Tool kit.....	6-2
Transfer case oil .....	6-13
Troubleshooting.....	6-42
Troubleshooting chart.....	6-43
Turn signal indicator lights .....	3-2
Turn signal light bulb, replacing .....	6-40
Turn signal switch.....	3-6

## V

Valve clearance, adjusting .....	6-19
Vehicle identification number .....	9-1

## W

Warranty, extended .....	9-9
Warranty limited.....	9-7
Wheel bearings, checking.....	6-35
Wheels .....	6-22







***PROTECT YOUR INVESTMENT***

***Use Genuine YAMAHA Parts And Accessories***

***See your Authorized YAMAHA Dealer for a Genuine YAMAHA Service Manual.***



YAMAHA MOTOR CO., LTD.

PRINTED ON RECYCLED PAPER

PRINTED IN JAPAN  
2002.07-0.5×2 CR  
(E)