



Pro Series C33

Combination Primary and Backup Sump Pump System

Instruction Manual & Safety Warnings

PAIR OF PUMPS

Table of Contents

Important Safety Warnings and Instructions

Electrical precautions	1
Battery preparation	1
Battery precautions	1

Introduction

Items included in system	2
Additional items needed	2
System specifications	2

Installing the Pipe and Pump

3

Battery Instructions

4,5

System Connections

Connecting the backup pump	5
Installing the battery fluid sensor	5
Connecting the battery	6
Connecting the primary pump	6

Product Operation

Float switches	7
Controllers	7
1/8" weep holes	7

Understanding the Warning Lights and Alarms

Silencing the alarm during an emergency	7
Battery fluid low	7,8
Battery corroded or defective	8
Cleaning battery terminals	8
Replacing the battery	9
Not receiving AC power	10
Fuse alarm	10
Backup pump activated	10
Replacing the backup pump	11
Replacing the primary pump	12
Battery power level	13
Remote alarm	13

Testing the System

Testing the backup float switch	13
Testing the primary float switch	14

Maintenance Check List

14

Parts & Service Information

Technical support	14
-------------------	----

Replacement Parts Diagram & List

15

Troubleshooting Guide

16

Warranty

17



Important Safety Warnings & Instructions

SAVE THESE INSTRUCTIONS. This manual contains important SAFETY WARNINGS and OPERATING INSTRUCTIONS for the Pro Series combination sump pump system. You will need to refer to it before attempting any installation or maintenance. **ALWAYS** keep these instructions with the unit so that they will be easily accessible.

Failure to read and follow these warnings and instructions could result in property damage, serious injury, or death. It is important to read this manual, even if you did not install the Pro Series combination sump pump system, since this manual contains safety information regarding the use and maintenance of this product. **DO NOT DISCARD THIS MANUAL.**

ELECTRICAL PRECAUTIONS

⚠ DANGER

Risk of electrical shock and fire hazard. May result in death, serious injury, shock or burns. To help reduce these risks, observe the following precautions:

- **DO NOT** walk on wet areas of the basement until all power has been turned off. If the main power supply is in a wet basement, call an electrician.
- **ALWAYS** disconnect the pump from the power source before servicing or making adjustments.
- **ALWAYS** unplug the control unit and disconnect the cables from the battery before attempting any maintenance or cleaning.
- **NEVER** handle the pump or motor with wet hands or when standing on a wet or damp surface while the pump is plugged into the power source.
- **MAKE SURE THERE IS A PROPERLY GROUNDED RECEPTACLE AVAILABLE.** This pump is wired with a 3-prong grounded plug. To reduce the risk of electric shock, be certain that it is only connected to a properly grounded 3-prong receptacle (preferably with ground fault circuit interrupt). If you have a 2-prong receptacle, have a licensed electrician

replace it with a 3-prong receptacle according to local codes and ordinances.

- **NEVER** bypass grounding wires or remove the ground prong from the plug.
- **DO NOT** use an extension cord. The electrical outlet should be within the length of the pump's power cord, and at least 4 feet above the floor level to minimize potential hazards from flood conditions.
- **DO** protect the electrical cord from sharp objects, hot surfaces, oil and chemicals. Avoid kinking the cord.
- **MAKE SURE** the supply circuit has a fuse or circuit breaker rated to handle the power requirements noted on the nameplate of the pump.

CAUTION

To reduce the risk of hazards that can cause injury or property damage, observe the following precautions:

- **DO NOT** use the power cord or strain relief to carry the pumps. Use the handle.
- **DO NOT** pull on the cord to disconnect the system or the pump. Pull the plug.
- **DO NOT** expose the control units to rain or snow.
- **DO NOT** operate the pumps or control units if they have been damaged in any way.
- **DO NOT** use pumps in pits handling raw sewage, salt water, or hazardous liquids.
- **DO NOT** disassemble the pumps or control units. When service is required, contact Glentronics' technical support at 800-991-0466, option 3. Return the product to the manufacturer for any repairs at the following address:

Glentronics, Inc.
640 Heathrow Drive, Lincolnshire, IL 60069

BATTERY PREPARATION

⚠ WARNING / POISON

Sulfuric acid can cause blindness or severe burns. Avoid contact with skin, eyes or clothing. In the event of accident, flush with

water and call a physician immediately. KEEP OUT OF REACH OF CHILDREN.

To help reduce these risks, observe the following precautions:

- Someone should be within range of your voice or close enough to come to your aid when you work near a lead-acid battery.
- Have plenty of fresh water and soap nearby in case battery acid contacts skin, clothing or eyes.
- Wear eye and clothing protection and avoid touching your eyes while working with battery acid or working near the battery.
- If battery acid contacts skin or clothing, wash immediately with soap and water. If acid enters eye, immediately flood eye with running cold water for at least 15 minutes and get medical attention.
- Battery posts and terminals contain lead and lead compounds, chemicals known to the State of California to cause cancer and reproductive harm. Wash hands after handling.

BATTERY PRECAUTIONS

⚠ DANGER

Explosive gases could cause serious injury or death. Cigarettes, flames or sparks could cause battery to explode in enclosed spaces. Charge in well-ventilated area. Always shield eyes and face from battery. Keep vent caps tight and level.

To help reduce these risks, observe the following precautions:

- **NEVER** smoke or allow a spark or flame in the vicinity of the battery.
- Use the Pro Series control unit for charging a LEAD-ACID battery only. **DO NOT** use the control unit for charging dry-cell batteries that are most commonly used with home appliances.
- Be sure the area around the battery is well-ventilated.
- When cleaning or adding water to the battery, first fan the top of the battery with a piece of cardboard or another non-metallic material to blow away any hydrogen or oxygen gas that may have been emitted from the battery.

• **DO NOT** drop a metal tool onto the battery. It might spark or short-circuit the battery and cause an explosion.

• Remove personal metal items such as rings, bracelets, watches, etc. when working with a lead-acid battery. A short circuit through one of these items can melt it causing a severe burn.

• **ALWAYS** remove the charger from the electrical outlet before connecting or disconnecting the battery cables. *Never allow the rings to touch each other.*

• Check the polarity of the battery posts. The POSITIVE (+) battery post usually has a larger diameter than the NEGATIVE (-) post.

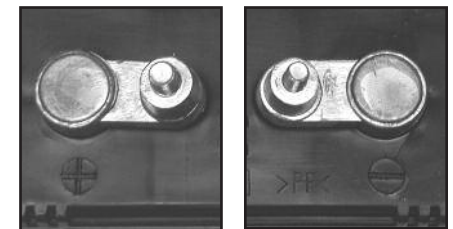

POSITIVE POST HAS LARGER DIAMETER

NEGATIVE POST HAS SMALLER DIAMETER

• When connecting the battery cables, first connect the small ring on the end of the WHITE wire to the NEGATIVE (-) post of the battery, and then connect the large ring on end of the BLACK wire to the POSITIVE (+) post of the battery.

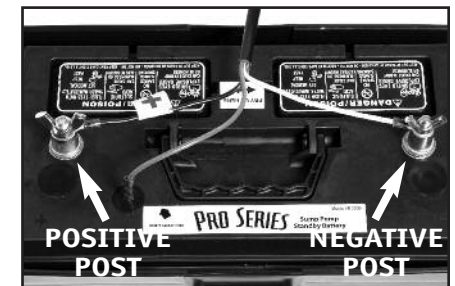

⚠ DANGER

Do not use system to pump flammable or explosive fluids such as gasoline, fuel oil, kerosene, etc.

Introduction

The Pro Series Pair of Pumps combination system is designed to provide both primary and backup pumping capabilities. The primary pump will operate as long as it is receiving AC power. If the power is interrupted, or more water is coming into the sump than the AC pump can handle, the backup sump pump will begin pumping automatically. The backup system has unique monitoring features that diagnose a problem and sound an alarm. A light on the display panel of the control unit will indicate the cause of the alarm and the corrective action. The two systems have been pre-assembled for easy installation.

To extend the battery run time, two batteries may be connected to the Pro Series C33 system by purchasing a second battery and acid pack, as

well as a set of battery jumper cables. Jumper cables specifically designed for this use are available from the manufacturer, Glentronics, Inc.

The Pair of Pumps Combination Sump Pump System includes:

- A 1/3 HP primary pump with a caged dual float switch, and a blue piggyback controller that plugs into the wall outlet
- A gray backup pump
- A gray control unit with a battery fluid sensor, a dual float switch, battery cables, and an internal 13 amp charger
- A battery cap with a hole to accommodate the fluid sensor
- A battery box
- A rubber union
- A battery filler bottle for adding distilled water to the battery



You will also need to supply:

- A Pro Series B-2200 Standby Battery or a Pro Series B12-90 Maintenance-Free Battery. The internal construction of some wet cell batteries may not be compatible with this system. Glentronics can not guarantee the compatibility of other brands of batteries. The use of a Pro Series battery is **HIGHLY** recommended.
- **DO NOT** use an automotive battery with this system
- **DO NOT** use a Pro Series 1000 battery with this system. It will not run the pump as long

as the Pro Series B-2200 battery

- A surge protector (recommended)
- Six (6) quarts of 1.265 specific gravity battery acid



For some installations you may need additional items:

- 1-1/2" rigid PVC pipe to connect to the existing plumbing
- A PVC pipe connector or a rubber union
- PVC pipe cleaner and cement



To connect two batteries you will need:

- Two (2) batteries of similar age and capacity (so they will have equal power)
- Another battery box (optional)
- Two (2) acid packs to fill the dry batteries
- A set of battery cables with rings on both ends to connect the two batteries together (available from Glentronics, Inc.)

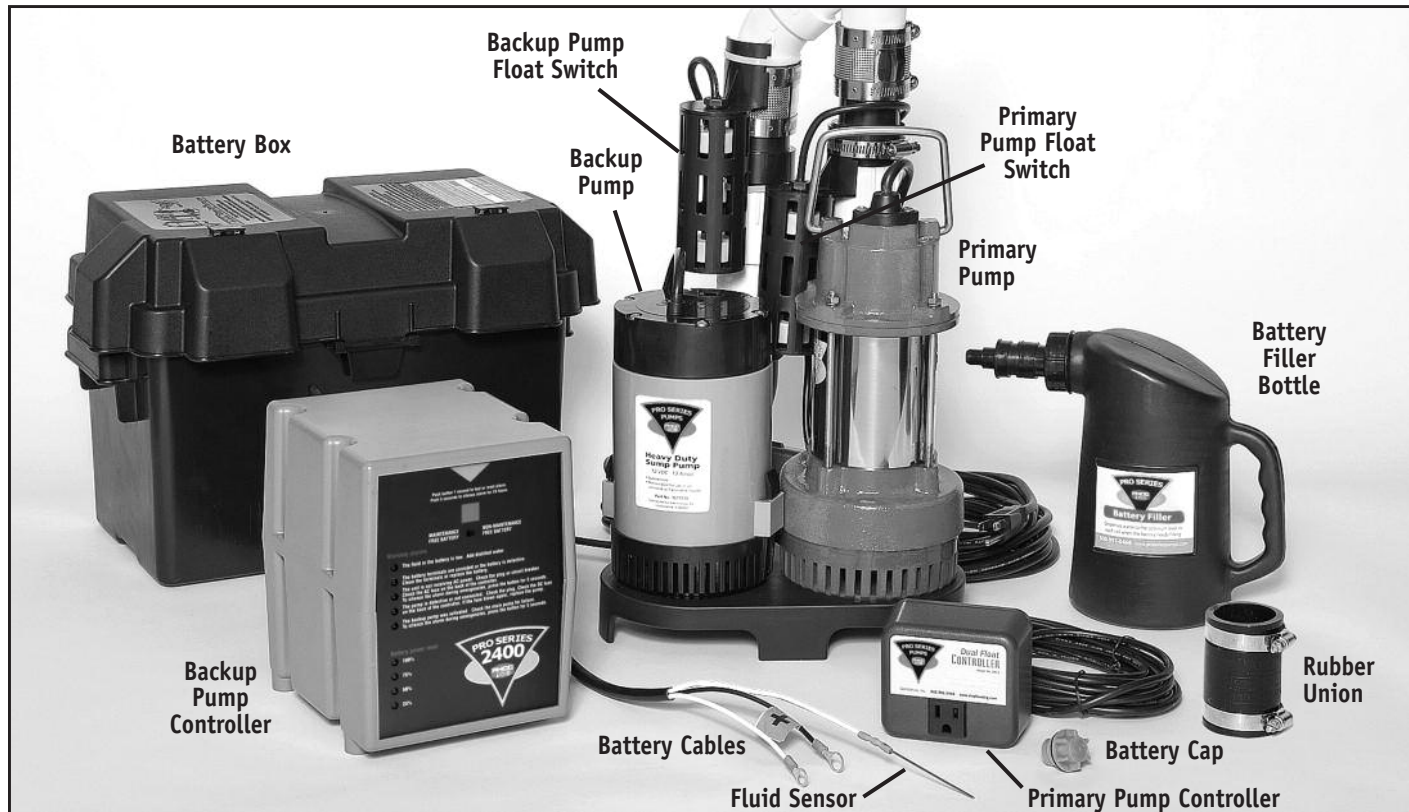

System Specifications

Power supply requirements115 volts, 60 Hz
 AC pump pumping capacity.....3000 GPH @ 10'
50 GPM @ 10'
 DC pump pumping capacity2400 GPH @ 10'
40 GPM @ 10'
 Overall dimensions.....11" W x 23 3/4" H

Installing the Pipe and Pump

The Pro Series Pair of Pumps combination system is compact and will fit in a sump pit as small as 12" wide. It measures 23³/₄" inches from the bottom of the pump stand to the top of the Y-connector where it will be attached to the discharge pipe.

Use a pit that conforms to all local codes, and check the code to see if a gate valve or ball valve is required.

The discharge pipe must be positioned in a downward slope when it exits the building, so any remaining water will drain away. Failure to do this will prevent water from exiting the pit, and damage the pump if the line freezes.

The system should be placed on a flat surface free from dirt and debris. If the bottom of the sump pit is not clean, remove as much of the debris as possible. The pumps are attached to a sump foot (stand) to raise them above any debris.

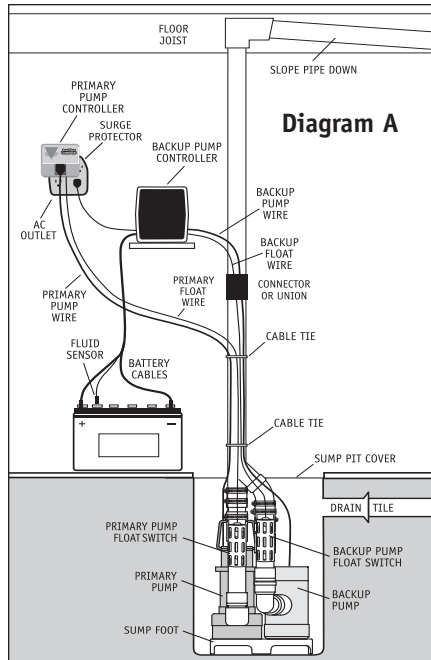
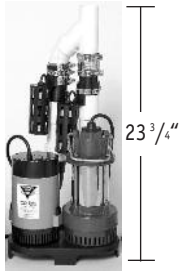

If you are replacing an old sump pump, unplug the pump from the outlet.

1. Remove the check valve or rubber union. Discard the check valve. The Pro Series system contains built-in check valves, so the old check valve will not be needed. If the existing system is installed without a check valve or rubber union, saw the pipe apart above the sump pit. (Refer to the diagram in step 3)
2. Remove the old pump from the pit, and unscrew the pipe and pipe adapter from the pump. You can use this pipe to extend the discharge pipe, if needed.
3. Measure the distance from the bottom of the sump pit to the end of the discharge pipe. Subtract 24³/₄" inches (the height of the pump system + 1 inch). Cut a piece of 1-1/2" rigid PVC pipe to that length.
4. Connect this piece to the discharge pipe by cementing the two pieces together with a 1-1/2" PVC pipe connector. (Follow the instructions on the PVC pipe cleaner and cement.) OR, (b) connect the two pieces of pipe together with a rubber union.
5. Remove the attached cords and controllers from the carton and place them next to the pump system. **MAKE SURE THE CORDS AND CONTROLLERS DO NOT FALL INTO THE SUMP PIT.**
6. Loosen the hose clamps on the enclosed rubber union, and slide the union up on the discharge pipe until it is even with the bottom of the pipe.
7. Lift the combination system by the handle on the primary pump and lower it into the sump pit. Make sure it is level.
8. Inspect the two float switches. They should both be vertical.
9. Position the top of the pump system pipe so that it is directly below the discharge pipe. Slide the rubber union down until 1/2 of the rubber union is covering the pipe on the pumps, and the other half is covering the bottom of the discharge pipe. Tighten the hose clamp screws securely.

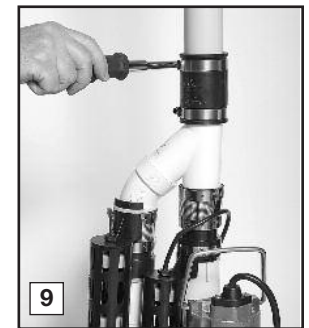
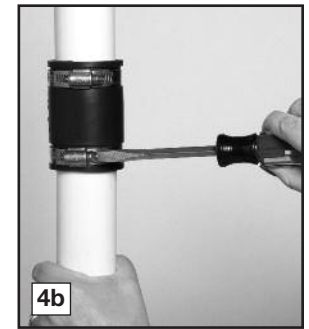
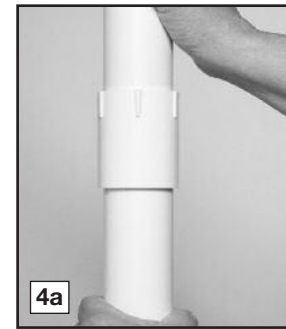
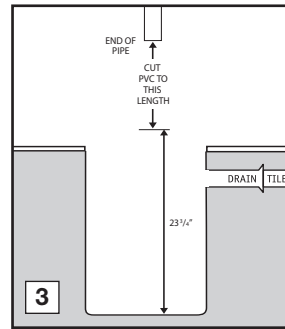
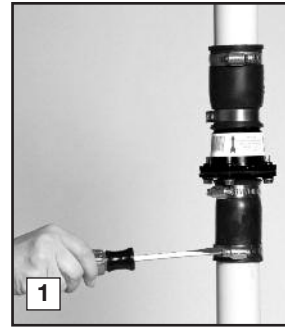

Battery Instructions

A new Pro Series B-2200 Standby Battery will run this system for a minimum of 8 hours.

To increase the running time of this system to 16 hours of continuous pumping, two batteries can be connected together. Ideally the batteries should be of similar age and capacity. Connecting an old and new battery together will not charge properly. Specific connection instructions will be explained on page 6.

In addition, the unique materials in the Pro Series B-2200 Standby batteries enable them to last for five to seven years in standby service.

CAUTION

- The use of automotive batteries is NOT recommended. Automotive batteries are not designed for this application. They will only run the pump for a short time and will have a shorter life than a standby battery.
- The battery fluid sensor is designed to fit the Pro Series Standby batteries. Measuring the battery fluid is one of the most important features of the system, since about 80% of backup sump pump failures are the result of a battery that has dried out.
- The internal construction of some wet cell batteries may not be compatible with this system. The use of a Pro Series B-2200 or B12-90 battery is HIGHLY recommended.

⚠ DANGER

DO NOT insert the fluid sensor into any battery except a Pro Series Standby battery. DO NOT drill a hole in another brand of battery to accommodate the fluid sensor. Batteries emit explosive gases which can cause serious injury or death.

PREPARING THE PRO SERIES STANDBY BATTERY

The Pro Series Standby batteries are shipped dry (without acid) so they never lose power before you take them home. A battery is activated when the acid is added, and then it slowly begins to deteriorate as it ages. By adding the acid just before use, the battery will always be fresh. Use 1.265 specific gravity battery acid to fill the battery. It is available where you purchased the battery.

NOTE: Pro Series batteries now come in two configurations. The tops of the batteries look different, and the directions for filling the batteries and connecting the fluid sensor will vary slightly. Instructions for both batteries follow. If the top of your battery looks like the photo of BATTERY A, follow the instructions on this page. If the top of your battery looks like the photo of BATTERY B, follow the instructions on page 5.

⚠ DANGER/POISON

Contains sulfuric acid. Wear eye and clothing protection. If battery acid contacts skin or clothing, wash immediately with soap and water. If acid enters eyes, flush with water for 15 minutes and get prompt medical attention. Review the safety instructions on page 1.

TO FILL THE BATTERY

1. Place the battery box on the floor. Place the dry (unfilled) battery into the battery box.
2. Remove the foil seal on the top of the battery.
3. Carefully push in the perforated tab at the top of the acid pack. Lift up the large tab and pull out the dispensing hose. Hold the hose upright above the pack and squeeze the hose forcing all the acid back into the pack.
4. Position the acid pack and battery as shown below. Pinch the end of the hose together and cut off the tip. Insert the end of the hose

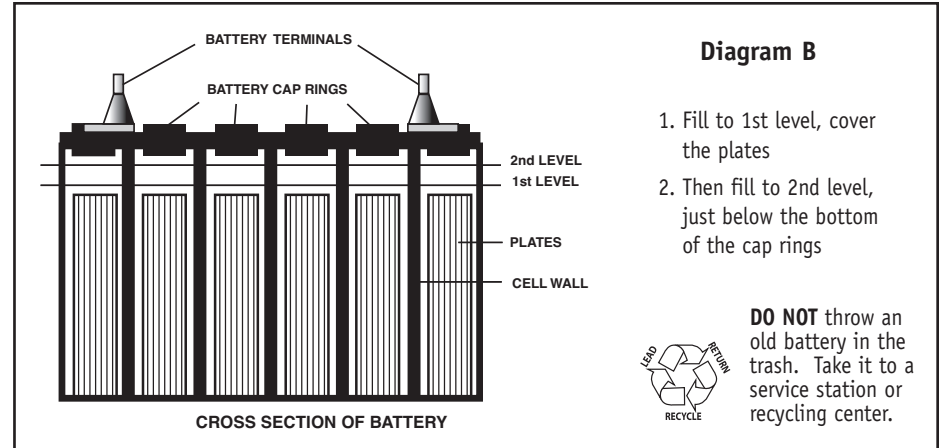
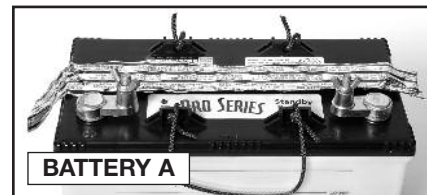

into each cell. Control the flow by pinching the hose with thumb and forefinger. **Fill each cell of the battery to a level just covering the battery plates, and then go back and top off each cell equally. It is important to have all the cells filled equally or the battery will not operate properly.** The acid should reach a level about ¼" below the cap ring as shown in the diagram above. DO NOT OVERFILL THE BATTERY. (Diagram B)

A newly filled battery will sometimes require additional acid after about 20 minutes. Re-examine the fill level, and add additional acid if necessary. The battery acid may bubble at this time and give off a sulfur-like smell, but this is normal. After the battery has been filled, screw the caps securely on the top of the battery.

The battery will be charged 70-80% 30 minutes



after adding the acid. The system will then finish charging the battery. During this time the alarm may sound. The alarm will shut off within 24 hours.

CAUTION

When you fill the battery for the FIRST time, it will be the ONLY time you add acid to the battery. In the future, when the fluid level is low, add distilled water to the cells. NEVER add more acid.



This backup system will also accommodate a maintenance-free battery, eliminating the need to fill the battery. The fluid sensor is not needed with this battery. However, you **MUST** attach the fluid sensor to the positive post of the battery to silence the fluid alarm. Slide the switch on the front of the controller panel to the type of battery being used with the system.





If your battery looks like the battery above, follow these directions.

1. Place the battery box on the floor. Place the dry (unfilled) battery into the battery box.
2. Remove the two battery caps by lifting them up with a screwdriver. **DO NOT** lift the cap by prying it up from the groove on the back of the cap. It may damage the vent.
3. Carefully push in the perforated tab at the top of the acid pack. Lift up the large tab and pull out the dispensing hose. Hold the hose upright above the pack and squeeze the hose forcing all the acid back into the pack.
4. Position the acid pack and battery as shown at the right. Pinch the end of the hose together and cut off the tip. Insert the end of the hose into each cell. Control the flow by pinching the hose with thumb and forefinger. **Fill each cell of the battery to a level just covering the battery plates, and then go back and top off each cell equally.**



It is important to have all the cells filled equally or the battery will not operate properly. The acid should reach a level about ¼" below the cap ring as shown in Diagram B on the previous page. **DO NOT OVERFILL THE BATTERY.**

A newly filled battery will sometimes require additional acid after about 20 minutes. Re-examine the fill level, and add additional acid if necessary. The battery acid may bubble at this time and give off a sulfur-like smell, but this is normal. After the battery has been filled, press the caps securely on the top of the battery.

The battery will be charged 70-80% 30 minutes after adding the acid. The system will then finish charging the battery. During this time the alarm may sound. The alarm will shut off within 24 hours.

CAUTION

When you fill the battery for the FIRST time, it will be the ONLY time you add acid to the battery. In the future, when the fluid level is low, add distilled water to the cells. NEVER add more acid.

This backup system will also accommodate a maintenance-free battery, eliminating the need to fill the battery. The fluid sensor is not needed with this battery. However, you **MUST** attach the fluid sensor to the positive post of the battery to silence the fluid alarm. Slide the



switch on the front of the controller panel to the type of battery being used with the system.

System Connections

⚠ DANGER

Risk of electrical shock or battery explosion, which can cause serious injury or death. Wear eye protection. Work in a well-ventilated area. DO NOT smoke or allow a spark or flame in the vicinity of the battery. Avoid dropping metal tools on the battery. If battery acid contacts eyes, flush with water for 15 minutes and get prompt medical attention. Review the safety instructions on page 1.

Position the backup system control unit in a secure place approximately four (4) feet above the floor. Be sure the power cord will reach the AC power outlet, and the pump cable and the float switch will reach the bottom of the sump pit. Position the unit in a well-ventilated area. Do not place anything on top of the battery. Do not place anything on top of the control unit. (Diagram C)

1. **Connecting the backup pump:** Remove the security tag from the pump and plug the pump wires into the pump connector on the back of the control unit.

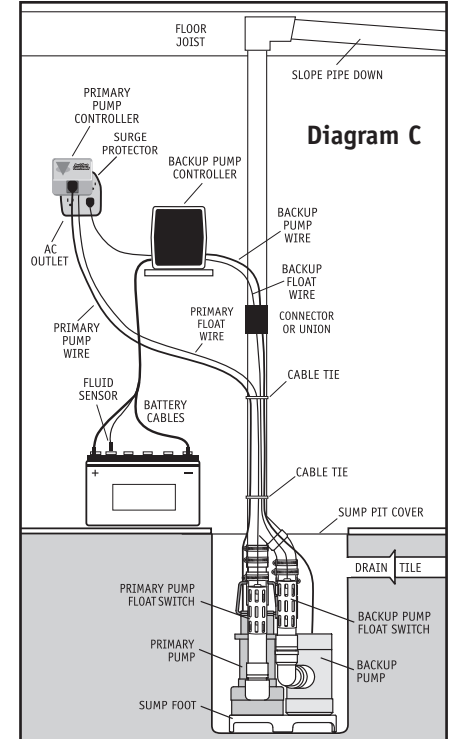

2. **Installing the battery fluid sensor:** Remove the cover of the battery box by pushing in the tabs on the front and back, then lifting up. Fan the area around the top of the battery with a piece of cardboard (or another non-metallic material) to remove any hydrogen or oxygen gas that may have been emitted from the battery.
3. If you are using BATTERY A, replace the battery cap that is 2nd from the POSITIVE (+) post with the battery cap that is provided in the Pro Series package. An arrow on the top of the battery marks this position. There are two holes in the battery cap. Insert the fluid sensor in the hole that is off-center on the top of the cap. *Do not glue the sensor into the cap.*
4. If you have BATTERY B, a hole has been molded into the top of the battery to accept the fluid sensor rod. The sensor hole is marked by the label on top of the battery. Hold the sensor straight and press it firmly into the hole all the way up to the connector. Do not bend the sensor rod.
5. *If you are using two batteries on the system, the fluid sensor should be placed in the battery directly connected to the controller.*



CAUTION

6. **If you are not using the Pro Series Standby battery, you cannot use the battery fluid sensor. However, you must attach the sensor to the POSITIVE (+) post of the battery or the alarm will sound continuously. The Pro Series sump pump system will not warn you if the fluid level is low in this configuration. You will need to check your battery every couple of months to see if it needs water. If the battery dries out, the system will not work. If you are using a maintenance-free battery, you cannot add fluid to the battery. The sensor must be attached to the POSITIVE (+) post of the maintenance-free battery to disconnect the fluid alarm.**
7. **Connecting the battery:** Remove the wing nuts from the battery terminals. Remove the security tag from the battery cables. Attach the battery cables to the battery...the WHITE wire to the NEGATIVE (-) post, and the BLACK wire to the POSITIVE (+) post. Replace the wing nuts and tighten them. Slide the switch on the front of the controller panel to the type of battery being used with the system.

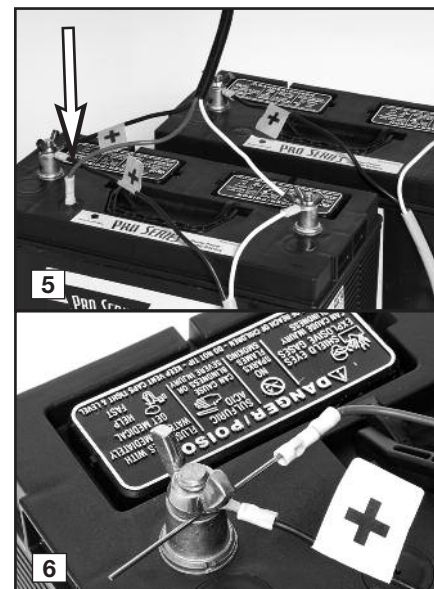

8. If you are connecting two batteries to the system, before you replace the wing nuts, connect the additional cable to the two batteries...the BLACK wires to the POSITIVE (+) posts and the WHITE wires to the NEGATIVE (-) posts of each battery. **NEVER** attach one end of the positive wire to the positive post and the other end of the positive wire to the negative post on the other battery.
9. Immediately plug the AC power cord from the gray control unit into a grounded AC wall outlet. (A surge protector that protects all three pins on the power plug is recommended.) You will have 10 seconds before the "Power failure" alarm will sound. The alarm will be silenced once the unit is plugged into the wall.
10. If any of the alarms are sounding, press the GRAY button on the front of the control panel for one (1) second
11. Secure the cover on the battery box by slipping the tabs through the fittings on the front and back of the box.

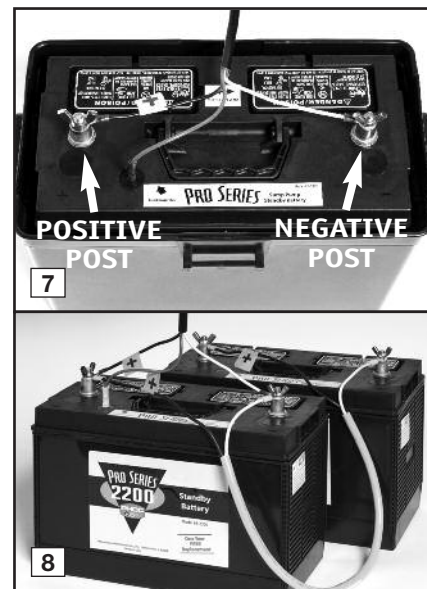

12. **Connecting the primary pump:** Plug the piggyback controller into a properly grounded 3-prong outlet (preferably with ground fault circuit interrupt). Then plug the primary pump into the receptacle on the controller.
13. For a neater installation, secure the cables from the controllers to the discharge pipe in a couple places with additional cable ties. Make sure the wires are not touching each other or overlapping each other.
14. After the initial installation, be sure to check the pump operation by filling the sump with water and observing the pump through one full cycle. The primary pump should run for 10 seconds after the lower float drops.
15. A pit cover is recommended for all installations as a safety measure, and to prevent debris from falling into the pit. Place the cover on top of the pit making sure not to pinch or crimp the pump wires with the cover. The pit cover usually has an existing hole that will allow the cords to be passed through it, or you can drill a hole in the cover.

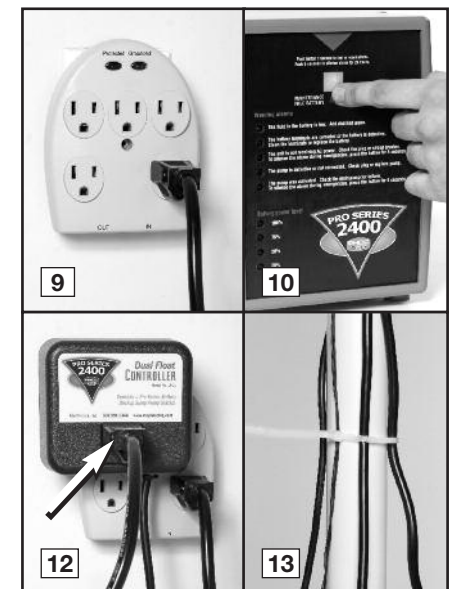

Product Operation

The dual float switch on the primary pump contains two large floating rings enclosed within a protective cage. Water will lift the bottom float by ¼", which will activate the pump. If for any reason the lower float does not activate the pump, the water will rise to the second float, and it will activate the pump. As the pump evacuates the water from the pit, the floats will drop. The pump will run for an additional 10 seconds to extend the cycle after the lower float drops. The blue controller for the primary pump powers this switch.

During a power outage, or when more water is entering the sump than the primary pump can handle, the backup pump will automatically begin pumping. It also has a dual float switch, so if one float fails to activate the pump, the second float will activate the pump as soon as the water reaches that level. As the water recedes below the float switch, a timer in the control unit will run the pump an additional 25 seconds to empty the pit.

While the pumps are active, water will come out of the 1/8" hole that is drilled in the pipe above the pump. This is normal.

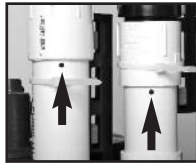

The hole is needed to prevent an air lock within the system. Do not obstruct this hole or an air lock may prevent the pump from activating, and the basement will flood.

Batteries and sump pumps need maintenance. The control unit on the backup system monitors the battery and power conditions, and sounds an alarm when maintenance is required. Following is an explanation of the warnings and alarms.

Understanding the Warnings and Alarms

The Pro Series control unit features a series of warning lights that pinpoint potential problems. In addition, an alarm sounds to alert you to the problem. In some cases the lights and alarm will go off automatically when the problem has been solved. In others, the GRAY button must be pushed to silence the alarm. Refer to the table at the right for a quick review of the features and their corresponding alarm status.



Warning	Alarm can be silenced before problem is corrected	Alarm shuts off automatically when problem is corrected
Battery fluid low	Yes	Yes
Battery problem	No	No, push GRAY button
Power or AC fuse failure	Yes	Yes
Pump or DC fuse failure	No	No, push GRAY button
Pump was activated	Yes	No, push GRAY button

SILENCING THE ALARM DURING AN EMERGENCY

If the alarm can be silenced before the problem is corrected, you may silence it for two (2) minutes by holding down the GRAY button for one (1) second. The alarm will be silenced, but the light will stay on. To silence the alarm for 24 hours, hold down the GRAY button for five (5) seconds. It will automatically reset itself after 24 hours. The warning light will stay on.

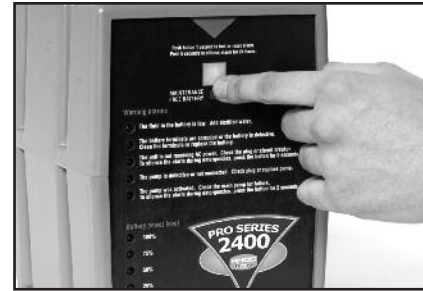

① The fluid in the battery is low

⚠ DANGER

Risk of electrical shock or battery explosion, which can cause serious injury or death. Wear eye protection. Work in a well-ventilated area. Do not smoke or allow a spark or flame in the vicinity of the battery. Avoid dropping metal tools on the battery. If battery acid contacts eyes, flush with water for 15 minutes and get prompt medical attention. Review the safety instructions on page 1.

REFER TO THE PHOTOS AT RIGHT & ON PAGE 8

If this warning light and alarm are on, you need to add distilled water to the battery.

1. Unplug the control unit power cord from the wall outlet.
2. Remove the cover of the battery box by pushing in the tabs on the front and back, then lifting up.
3. Fan the area around the top of the battery with a piece of cardboard (or another non-metallic material) to remove any hydrogen or oxygen gas that may have been emitted from the battery.
4. Then unscrew the wing nuts and remove the battery cables and the fluid sensor from the battery.
5. Pry up the two battery caps, or unscrew the six battery caps depending on the configuration of your battery. Add distilled water to the battery filler bottle and replace the nozzle. Place the nozzle of the battery filler into each cell of the battery and press

down. It will fill the battery cell to the correct level and stop automatically. If distilled water is not available, tap water with a low mineral content may be used. Well water is not recommended. **NEVER ADD MORE ACID.**

6. Replace the battery caps. Replace the fluid sensor in the hole on the top of the battery or in the yellow battery cap, depending on

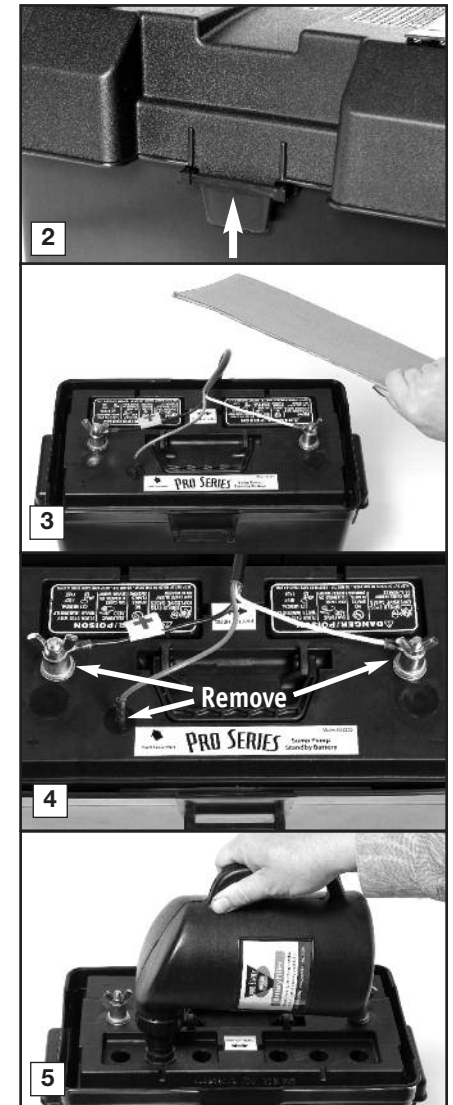

which battery you own. Be sure the fluid sensor is positioned in the second cell from the positive post. The hole is marked with an arrow. Replace the battery cables...the WHITE wire to the NEGATIVE (-) post, and the BLACK wire to the POSITIVE (+) post. Replace the wing nuts and tighten.

7. Replace the cover of the battery box.

8. Plug the controller back into the outlet. (You should provide additional protection for the control unit by using a surge protector.)

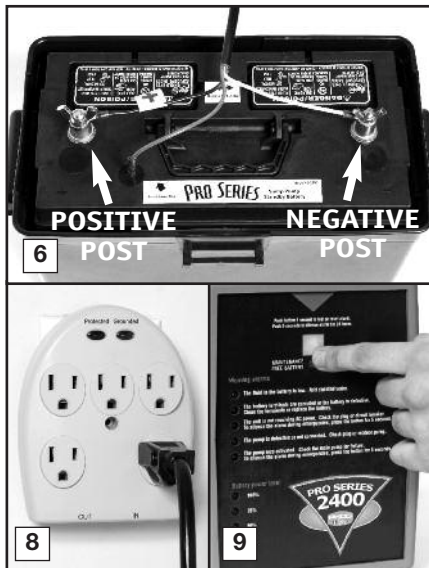

9. If any of the alarms are sounding, press the GRAY button on the front of the control panel for one (1) second.

② **The battery terminals are corroded or the battery is defective**

This light and alarm will come on when the control unit detects there is less than one (1) hour of pumping power left in the battery, or that the battery is defective. The alarm cannot be silenced, because action needs to be taken to protect your basement. If your battery is more than five (5) years old, replace it. If not, here are several situations that would cause the pump to run the battery for an extended time and discharge the battery: Check the following list before you replace the battery.

- If the 3rd light on the controller is also on, it means that the unit is not receiving AC power. Either the AC power is out, the circuit breaker has blown, or the outlet is bad. When the problem is corrected, the battery should recharge.
- If the 5th light on the controller is also on, check your main pump for failure. The backup pump may have been activated repeatedly if your main AC pump is broken, or you are experiencing heavy rains and your main pump cannot keep up with the inflow of water. You may need to upgrade or replace your main pump. When the problem is corrected, the battery should recharge.
- If no other lights are on, this means the terminals may be corroded, and the battery cannot charge properly. Unplug the control unit from the wall outlet. Then, check the battery cables and the battery terminals for corrosion. Clean and tighten them as needed. The procedure is described in the next column.
- If you are using a maintenance-free battery, the terminals will not corrode. However, the connections may be loose. Tighten the nuts on the battery terminals.
- If the battery terminals have been cleaned and the light is still on, there could be a problem with the controller or the battery. The best way to determine if the battery is the problem is to have it charged and load tested at any local car service station. If the battery is bad and less than one (1) year old, it can be returned to the place of purchase for a replacement (receipt required). If the battery is good, contact Glentronics' service department for further instructions. The phone number is 800-991-0466, option #3.

If the battery alarm goes on while the pump is running and the power is out, you will have a minimum of one (1) hour of continuous pumping time to replace the battery. (In most cases, the pump does not run continuously, and therefore, you actually have a longer time to replace it.)

You will not be able to silence the alarm. Left unattended, the basement will flood. In a severe emergency, if a replacement battery is not available, you could temporarily use your car battery, or recharge this battery by connecting it to your car battery.

Once the AC power is restored, the battery will recharge automatically, unless it is old or damaged. The alarm will remain on until the GRAY button is pressed for one (1) second.

In the event that your Pro Series sump pump system has pumped for an extended period of time, the battery may be very depleted. In this condition, when the AC power is returned to the unit, a battery alarm will continue to sound. The battery may need a longer period to recharge. Press the GRAY button for five (5) seconds to silence the alarm.

If the battery is completely discharged, an internal safety feature will not allow the charging system to activate. Call the Glentronics' service department for instructions or replace the battery.

TO CLEAN THE BATTERY TERMINALS AND CABLES

⚠ DANGER

Risk of electrical shock or battery explosion, which can cause serious injury or death. Wear eye protection. Work in a well-ventilated area. DO NOT smoke or allow a spark or flame in the vicinity of the battery. Avoid dropping metal tools on the battery. If battery acid contacts eyes, flush with water for 15 minutes and get prompt medical attention. Review the safety instructions on page 1.

1. Unplug the power cord from the wall outlet.
2. Remove the cover of the battery box by pushing in the tabs on the front and back, then lifting up.
3. Fan the area around the top of the battery with a piece of cardboard (or another non-metallic material) to remove any hydrogen or oxygen gas that may have been emitted from the battery.

4. Remove the fluid sensor from the top of the battery. Unscrew the wing nuts and remove the battery cables.
5. Clean the battery posts with a battery post terminal cleaner or a wire brush.
6. Clean any corrosion off of the ring connectors on the ends of the battery wires. Use a stiff

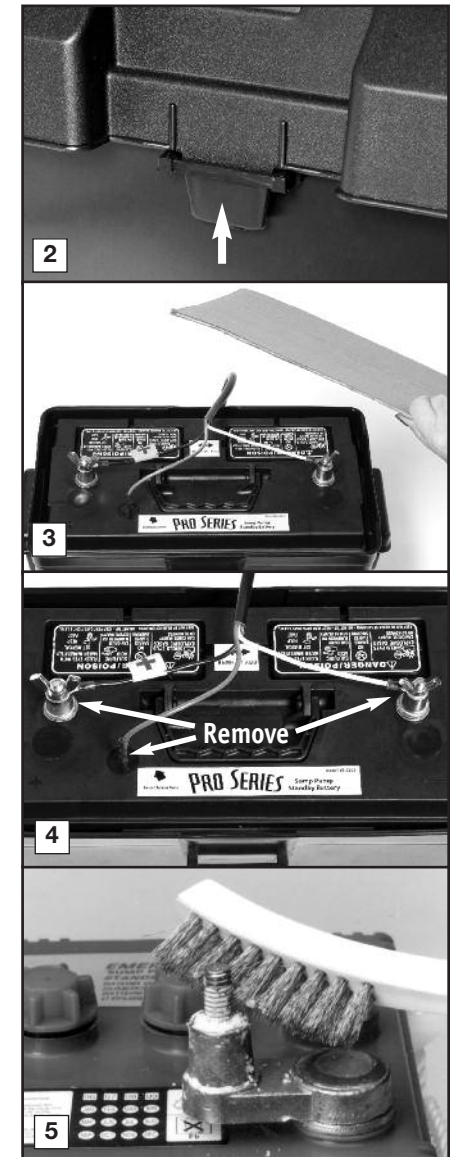

brush or sandpaper. **DO NOT** apply corrosion resisting sprays or pads to the terminal rings or posts after you have cleaned them, since this could prevent the battery from charging properly.

- Replace the fluid sensor in the top of the battery, or in the cap 2nd from the POSITIVE (+) post, depending on the configuration of your battery.
- Then replace the battery cables, WHITE to the NEGATIVE (-) post and BLACK to the POSITIVE (+) post. Tighten the wing nuts. If you are using a maintenance-free battery, attach the fluid sensor to the POSITIVE (+) post of the battery.
- Plug the power cord back into the wall outlet. (You should provide additional protection for the control unit by using a surge protector.)
- If any of the alarms are sounding, press the GRAY button on the front of the control panel for one (1) second.

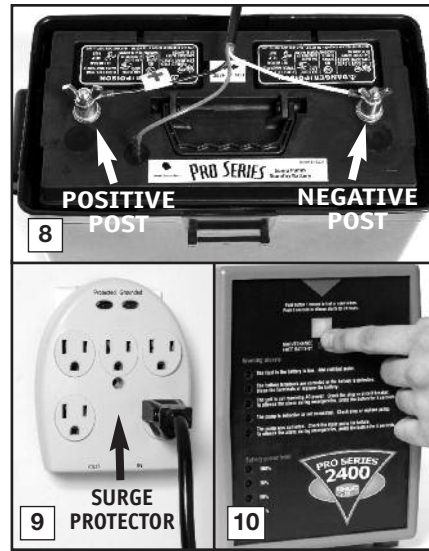

REPLACING THE BATTERY

⚠ DANGER

Risk of electrical shock or battery explosion, which can cause serious injury or death. Wear eye protection. Work in a well-ventilated area. **DO NOT** smoke or allow a spark or flame in the vicinity of the battery. Avoid dropping metal tools on the battery. If battery acid contacts eyes, flush with water for 15 minutes and get prompt medical attention. Review the safety instructions on page 1.

REFER TO THE PHOTOS AT RIGHT

- Unplug the power cord from the wall outlet.
- Remove the cover of the battery box by pushing in the tabs on the front and back, then lifting up.
- Fan the area around the top of the battery with a piece of cardboard (or another non-metallic material) to remove any hydrogen or oxygen gas that may have been emitted from the battery.
- Remove the fluid sensor from the top of the battery. Unscrew the wing nuts and remove the battery cables.
- Remove the old battery from the battery box and place the new battery in the box. Fill the battery following the instructions on page 4 or 5.

- Clean any corrosion off of the ring connectors on the ends of the battery wires. Use a stiff brush or sandpaper. **DO NOT** apply corrosion resisting sprays or pads to the terminal rings or posts after you have cleaned them, since this could prevent the battery from charging properly.
- Replace the battery cables, WHITE to the NEGATIVE (-) post and BLACK to the POSITIVE (+) post. Tighten the wing nuts. Slide the switch on the front of the controller panel to the type of battery being used with the system (maintenance free or non maintenance free).
- Insert the fluid sensor in the top of the battery. (a) If your battery has six (6) caps on the top, rinse and dry the bottom of the yellow cap with the extra hole from the old battery to remove any residue. Replace the battery cap in the cell that is second from the POSITIVE post with the cap from the old battery. Insert the fluid sensor in the cap. (b) If your battery has two caps, each covering three (3) battery cells, insert the fluid sensor in the hole in the top of the battery next to the arrow. (c) If using a maintenance free battery, you must attach

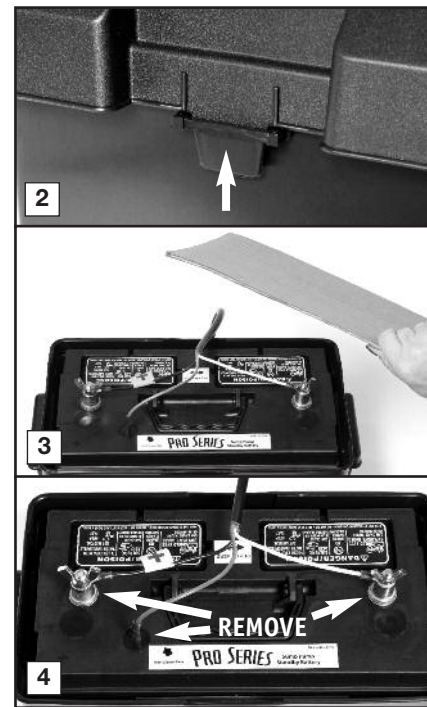

the fluid sensor to the POSITIVE post of the battery to silence the fluid alarm.

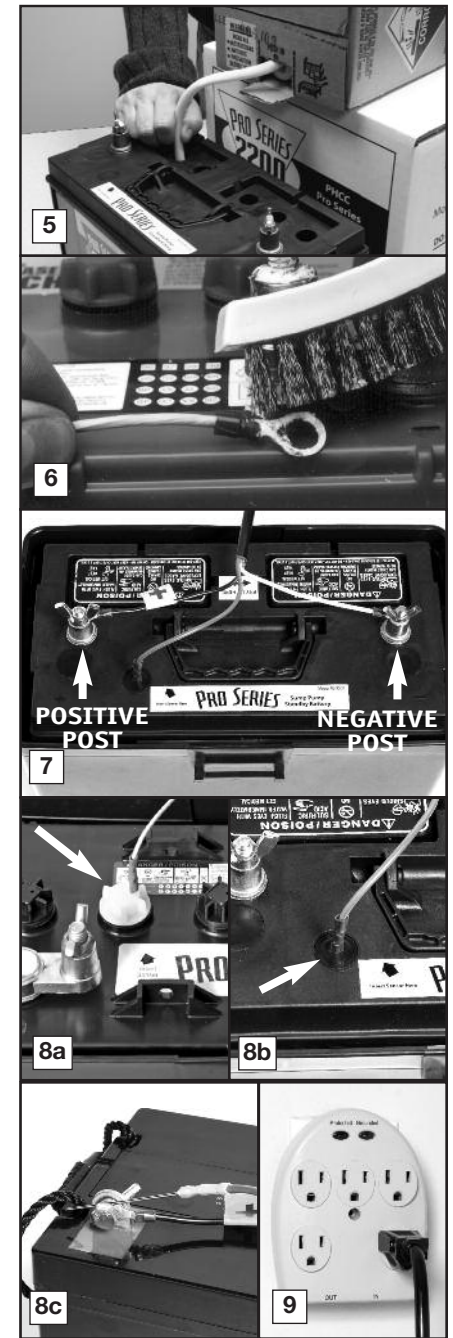

- Plug the power cord back into the wall outlet. (You should provide additional protection for the control unit by using a surge protector.)
- If any of the alarms are sounding, press the GRAY button on the front of the control panel for one (1) second.

③ The unit is not receiving AC power

There are several causes for power failure. The most common is a power outage by your electric company. During this emergency, the Pro Series system will automatically switch to battery power and protect your basement from flooding. You can silence the "AC power failure" alarm for 24 hours by pressing the GRAY button for five (5) seconds. The alarm will be silenced, but the light will stay on. The system will continue to operate while the power alarm is silenced. After 24 hours, the alarm will reset automatically.

- If the power is on in the rest of the house, check the home circuit breaker or fuse box for failure, and correct the problem.
- Check the power cord. Make sure it is securely plugged into the wall outlet. Make sure the outlet is working properly.
- The control unit may have received a power surge. (a) Check the AC fuse located on the back panel of the control unit. First, unplug the control unit from the wall outlet. Then, unscrew the barrel fuse and check to see if the wires in the fuse are intact. To remove the barrel fuse, push in and turn counter-clockwise. Replace the fuse by pushing it in

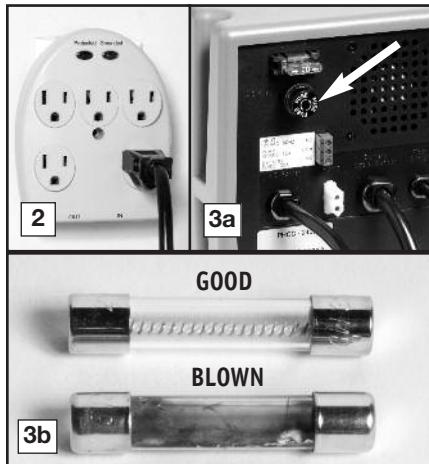

and turning clockwise. (b) If the wires are burned and broken, replace the fuse with a 5 amp glass barrel fuse, commonly found at hardware stores and auto supply stores. Plug in the control unit. (You should provide additional protection for the control unit by using a surge protector.) If the fuse blows again, call Glentronics technical support at 800-991-0466, option #3.

The control unit must receive 115 volts AC +/- 5% from the AC outlet. Voltage lower than 110 volts will activate the power failure alarm. Lower voltages can be caused by utility company brown outs or a heavy power draw from other appliances on the same circuit. Reduce the number of appliances on the circuit.

④ The pump or DC fuse is defective

⚠ DANGER

Unplug the main AC pump before servicing the backup pump to avoid electric shock. Failure to do so could cause serious injury or death.

REFER TO THE PHOTOS BELOW

The Pro Series control unit will check the pump and its wire connections each week for possible pump failure. The system will test the pump by running it for 2-3 seconds to make sure it is operating. The test will not trigger an alarm. If the "Pump or DC fuse" alarm sounds:

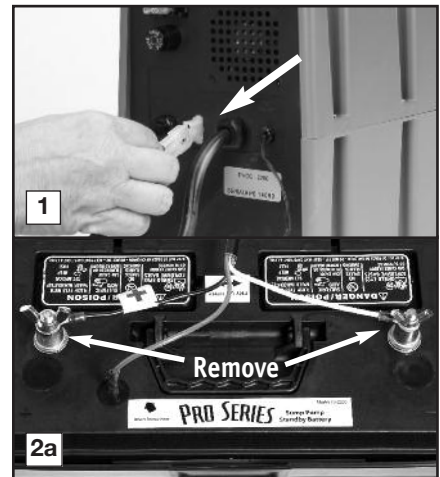

- Check the pump plug in the back of the unit to make sure it is firmly connected. Check the pump wires to make sure they are connected securely to the pump plug. Check the rest of the pump wires for any possible breaks.
- If the pump wires are intact, the pump may be clogged. (a) Disconnect both control units from the wall outlet, and disconnect the battery cables. (b) Release the union, and remove the pumps from the sump pit. (c) Rinse any debris from the strainer, and then reconnect the pumps to the discharge pipe. (d) Connect the control unit, and the battery

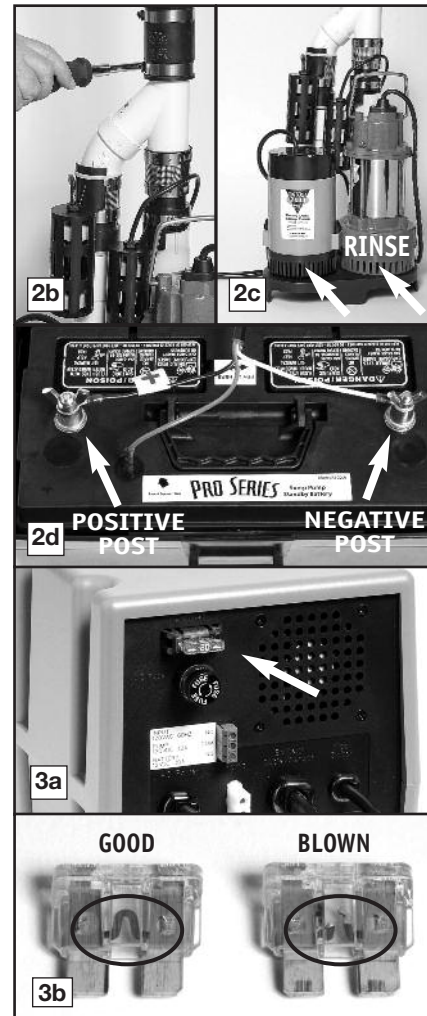

cables to the battery...the WHITE wire to the NEGATIVE (-) post, and then the BLACK wire to the POSITIVE (+) post. Tighten the wing nuts on the battery posts. (e) Plug the control unit back into the wall outlet.

- (a) Check the DC fuse by pulling it out of the fuse holder. (b) If the wires are burned and broken, replace the fuse with a 20 amp DC safety fuse. If the fuse blows again, unplug the computer control unit from the wall and disconnect the battery cables from the battery. Then call Glentronics technical support for instructions at 800-991-0466, option #3. You may need to replace the pump.
- Plug the main AC pump back into the wall outlet.

⑤ The pump was activated

When water rises in the sump pit and lifts the float switch, the pump will begin pumping, and the "Pump was activated" light and alarm will turn on. The pump warning stays on to alert you to the fact that the standby system was used to empty the water from the sump. Try to determine what caused the system to activate.

- Check the main pump for failure. It may not be working, the float switch may be stuck, or it may be too small to handle the inflow of water.
- Make sure the check valve is working. It may need to be replaced.
- Make sure the discharge pipe is not clogged or frozen.
- If the power was out, the backup pump was automatically activated. You need to push the GRAY button to silence the alarm.

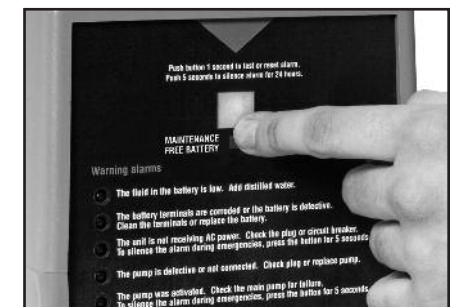

REPLACING THE BACKUP PUMP

Before you begin this process, you will need a new backup pump, new check valves, and new wire ties. The check valves have a 1½" MPT on one end, and a 1½" SLIP on the other end. See page 15 for part numbers.



⚠ DANGER

Risk of electrical shock or battery explosion, which can cause serious injury or death. Wear eye protection. Work in a well-ventilated area. **DO NOT** smoke or allow a spark or flame in the vicinity of the battery. Avoid dropping metal tools on the battery. Review the safety instructions on page 1.

YOU WILL BE DISCONNECTING ALL THE WIRES. BE SURE THEY DO NOT FALL INTO THE SUMP PIT.

1. Unplug the primary pump, the blue controller, and the power cord for the backup pump control unit from the wall outlet.
2. Unplug the backup pump from the back of the gray control unit.
3. Remove the cover of the battery box and fan the area around the top of the battery with a piece of cardboard (or another non-metallic material) to remove any hydrogen or oxygen gas that may have been emitted from the battery
4. Remove the sensor from the battery, and remove the battery wires from the battery terminals. Be sure they **DO NOT** touch each other while one is connected to the battery.

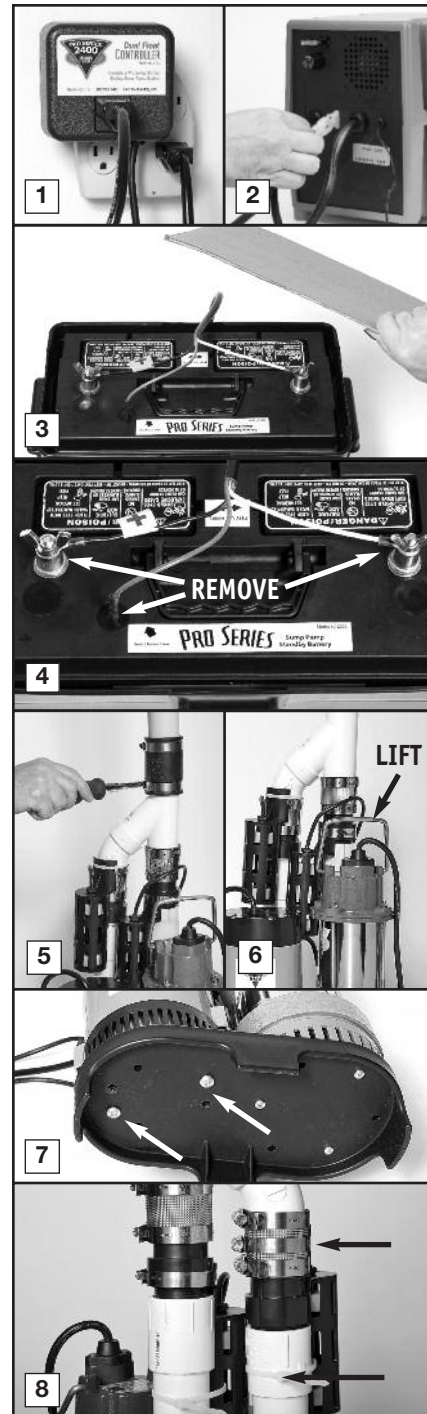

5. Slowly loosen the rubber union on the top of the combination pump assembly to separate the pipes. The water trapped in the pipe will pour out into the sump as the rubber union is loosened.
6. Separate the pump assembly from the rubber union and lift it out of the sump pit by the handle on the primary pump. Tip the assembly over the sump pit to drain away any remaining water.
7. Lay the pumps down and remove the two (2) screws holding the backup pump.
8. Loosen the hose clamp holding the float switch, cut the wire tie holding the switch, and remove the switch from the pipe. Note its position.
9. Loosen the hose clamps on the no-hub connectors on both pumps.
10. Ease the Y-assembly off of the pumps.
11. Unscrew the pipe adapter from the backup pump.
12. While you have the pump apart, this would be a good time to replace the check valves. A check valve with 1½" MPT on one end, and 1½" SLIP on the other is commonly available, or you may order this part #1141001 from Glentronics.
13. Now, reverse the process. Replace the pump by first screwing the adapter assembly into the new pump.
14. Then screw the pump to the pump stand.
15. Ease the Y-assembly back onto the check valves, and tighten the hose clamps.
16. Install the backup pump float switch on the check valve with the hose clamp, and secure the cage to the discharge pipe with a wire tie. Make sure the floats are vertical.
17. Lower the pumps into the sump pit by the handle on the primary pump.
18. Ease the Y-assembly back into the rubber union on the discharge pipe and tighten the hose clamps.

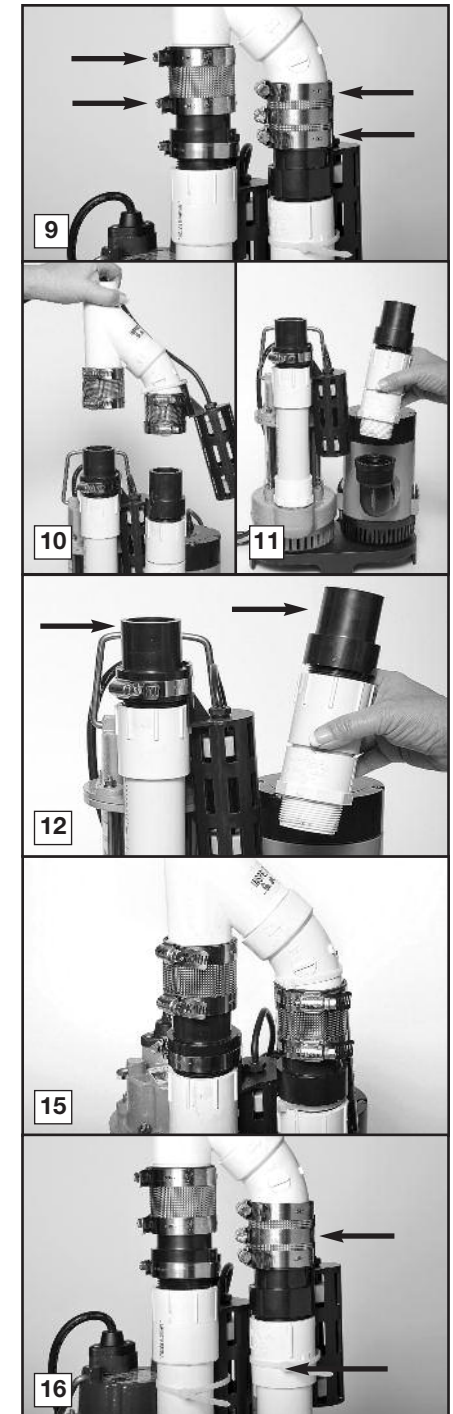

19. Connect the backup pump to the back of the gray control unit.
20. Insert the fluid sensor into the top of the battery, or into the battery cap, depending on which battery you own.
21. Connect the battery wires to the battery terminals, WHITE to the NEGATIVE (-) post, and BLACK to the POSITIVE (+) post.
22. Plug the power cord from the gray control unit into the outlet. You should provide additional protection for the system by using a surge protector.
23. Plug the primary pump into the blue controller, and plug both into the wall outlet.
24. If any of the alarms are sounding, press the GRAY button for 1 second.

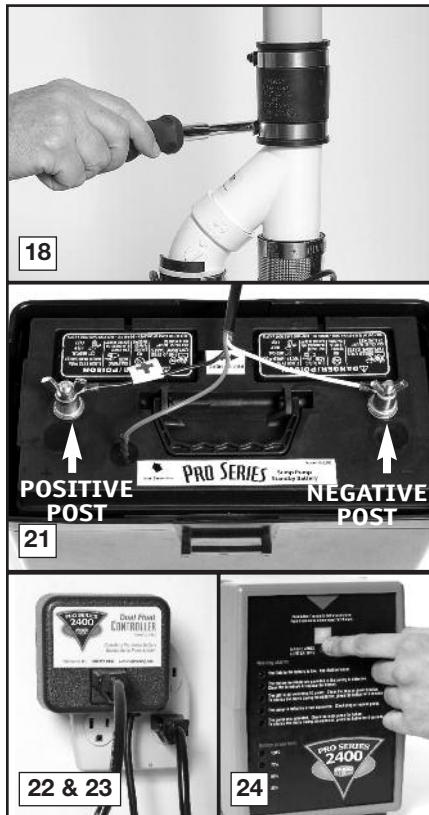

REPLACING THE PRIMARY PUMP

Before you begin this process, you will need a new AC pump, new check valves, and new wire ties. The check valves have a 1½" MPT on one end, and a 1½" SLIP on the other end. See page 15 for part numbers.



⚠ DANGER

Risk of electrical shock or battery explosion, which can cause serious injury or death. Wear eye protection. Work in a well-ventilated area. DO NOT smoke or allow a spark or flame in the vicinity of the battery. Avoid dropping metal tools on the battery. Review the safety instructions on page 1.

YOU WILL BE DISCONNECTING ALL THE WIRES. BE SURE THEY DO NOT FALL INTO THE SUMP PIT.

1. Unplug the primary pump, the blue controller, and the power cord for the backup control unit from the wall outlet.
2. Unplug the backup pump from the back of the gray control unit.
3. Remove the cover of the battery box and fan the area around the top of the battery with a piece of cardboard (or another non-metallic material) to remove any hydrogen or oxygen gas that may have been emitted from the battery.
4. Remove the sensor from the battery; remove the battery wires from the battery terminals. Be sure they **DO NOT** touch each other while one is connected to the battery.
5. Slowly loosen the rubber union on the top of the combination pump assembly to separate the pipes. The water trapped in the pipe will pour out into the sump as the rubber union is loosened.

6. Lift the pump assembly out of the pit by the handle on the primary pump. Tip the assembly over the sump pit to drain any remaining water.
7. Lay the pumps down and remove the three (3) screws holding the primary pump to the "sump foot". The strainer on the primary

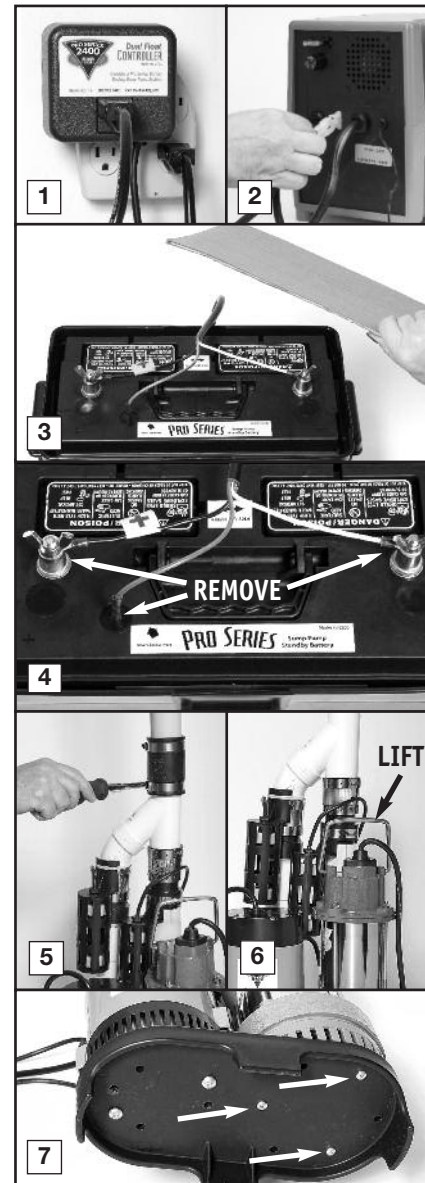

pump will separate from the pump when the screws are removed. **SAVE THESE SCREWS** or replace them with #10-24 x 1½" stainless steel screws.

8. Loosen the hose clamp holding the float switch, cut the wire tie holding the switch, and remove the switch from the pipe. Note its position.
9. Loosen the hose clamps on the no-hub connector on top of the primary pump and ease the pump out of the connector.
10. While you have the pump apart, this would be a good time to replace the check valves. A check valve with 1½" MPT on one end, and 1½" SLIP on the other is commonly available, or you may order this part #1141001 from Glentronics.
11. Remove the screws from the strainer on the new primary pump and discard them before you place it on the "sump foot". You will

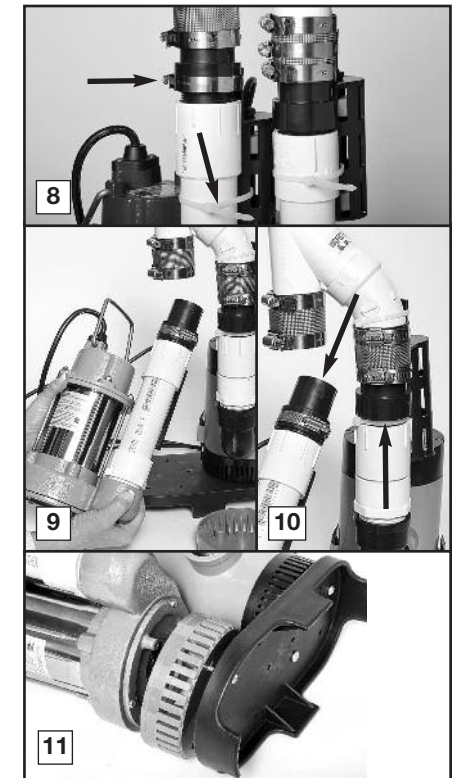

- need to thread the old screws through the foot, the strainer and into the pump.
- Line up the discharge pipes parallel to each other and start with the top screw. Once the top screw is replaced, the other screws will line up with the holes. Tighten all the screws.
 - Install the float switch on the check valve with a hose clamp, and secure it to the discharge pipe with a wire tie. Make sure the floats are vertical.
 - Ease the pump back into the no-hub connector and tighten the hose clamps.
 - Lower the pump back into the pit by the handle of the primary pump.
 - Connect the top of the system to the rubber union and tighten the hose clamp.

- Connect the backup pump to the back of the gray control unit
- Insert the fluid sensor into the top of the battery, or into the battery cap, depending on which battery you own.
- Connect the battery wires to the battery terminals, WHITE to the NEGATIVE (-) post, and BLACK to the POSITIVE (+) post.
- Plug the power cord from the gray control unit into the outlet. You should provide additional protection to the system by using a surge protector.
- Plug the primary pump into the blue controller, and plug both into the wall outlet.
- If any of the alarms are sounding, press the GRAY button for 1 second.

⑥ Battery power level

Your Pro Series backup sump pump system has a gauge which will report the level of charge remaining in the battery. As the battery's energy is depleted during operation without AC power, or simply by aging, the gauge will indicate the percent of charge remaining in the battery. Should the level drop below 25%, the "Battery problem" indicator will light up and the alarm will sound.



an open (no contact) or closed (making contact) connection is needed to activate the alarm.

The security system will provide two connection terminals. You will need to extend wires from the security system to the Pro Series control unit. Strip the two wires, 1/4" each. Connect either wire to the common terminal. To secure the wire into the terminal, insert the exposed wire into the hole on the back of the terminal next to the screw marked common. Turn the screw a few turns to lock-in the wire.

If the security system requires a closing of a contact to activate the alarm, secure the other wire in the terminal hole labeled N.O. (normally open). If the security system requires an opening of a contact, secure the wire in the terminal hole labeled N.C. (normally closed).

TESTING THE FLOAT SWITCH FOR THE BACKUP PUMP

It is important to manually test the float switches periodically.

⚠ DANGER

Unplug the main AC pump when installing or servicing the backup pump to avoid electric shock. Failure to do so could cause serious injury or death. Review the safety instructions on page 1.

Lift the float up with a pencil, or another non-metallic item, and let go. This will activate the pump. The control unit will run the pump for approximately 25 seconds so it can empty all the water in the sump pit. If there is no water in the pit, the pump can run dry for this amount of time. The alarm will sound and the "Pump was activated" light will go on. After the pump has stopped, push the GRAY button to silence the alarm. If the GRAY button is pressed before the pump has stopped, the alarm will go off temporarily. Wait for the pump to stop pumping, and then push the GRAY button on the front of the control unit to completely silence the alarm.

While the pumps are active, water will come out of the 1/8" hole that is drilled in the pipe above the

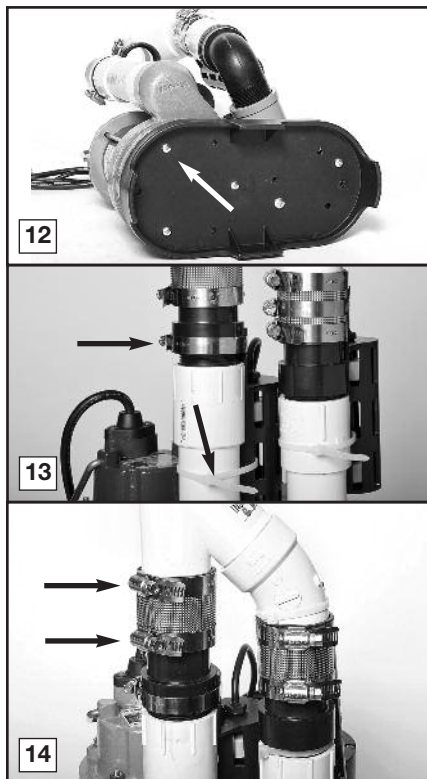

THE REMOTE TERMINAL

The Pro Series 2400 can be connected to a home security system or other alarm devices to alert you to a problem or required maintenance.



INSTRUCTIONS FOR CONNECTING THE REMOTE ALARM

The terminal is located on the back of the control unit. There are three (3) positions for wire connections on the terminal: N.C. - normally closed, N.O. - normally open, and common.

Check your security system to determine whether

pump. This is normal. The hole is needed to prevent an air lock within the system. **DO NOT** obstruct this hole or an air lock may prevent the pump from activating, and the basement will flood.

BE SURE TO PLUG IN THE MAIN AC PUMP WHEN YOU HAVE COMPLETED THE TEST.



TESTING THE FLOAT SWITCH FOR THE PRIMARY PUMP

Lift the float up with a pencil, or another non-metallic item, and let it go to activate the pump. The pump will run of an additional 10 seconds after the float returns to the original position. It will not damage the pump to run it for this short time if the sump pit is dry. However, **DO NOT** hold the float up for an extended time without water in the sump pit.

While the pumps are active, water will come out

of the 1/8" hole that is drilled in the pipe above the pump. This is normal. The hole is needed to prevent an air lock within the system. **DO NOT** obstruct this hole or an air lock may prevent the pump from activating, and the basement will flood.

MAINTENANCE CHECK LIST

Maintenance should be performed 1-2 times per year

1. Lift the float switches on both pumps as described above.
2. Remove all debris from the bottom of the pit.
3. Remove all debris floating in the water.
4. Remove all debris from the float switch cage.
5. Fill the pit with water. Make sure the pumps turn on at the intended levels.
6. While the pump is running, make sure the pump is evacuating water at a good pace and water is coming out of the 1/8" air bleed hole.
7. Remove the fluid sensor and yellow cap from the battery and rinse any residue buildup from the bottom of the battery cap. Replace the cap and fluid sensor.
8. Check battery fluid levels.

PARTS & SERVICE INFORMATION

You can receive technical support, parts, or service information by calling Glentronics, Inc. at **800-991-0466, option #3**, or by visiting the Pro Series website at www.stopflooding.com. Send your unit to the following address if repairs are needed:

Glentronics, Inc.
640 Heathrow Drive
Lincolnshire, IL 60069-4205

Replacement Parts List

PS -C33 Description

- Controller for backup pump
- Dual float switch with controller for AC pump
- 1/3 HP AC sump pump
- PHCC 2400 backup pump
- Battery box
- PVC "Y" fitting
- Battery cap with hole
- Sump foot
- Instructions
- Battery fill bottle
- Stainless steel screw, #10-24 x 1-1/2" *
- 45° PVC pipe fitting, 1-1/2" *
- Pipe adapter for backup pump, 1-1/2" FTP x 1-1/2" slip *
- Wire tie for float switch, 11" *
- Stainless steel hose clamp, 2-1/2" diameter *
- Check valve, 1-1/2" MPT x 1-1/2" SLIP *
- No-hub coupling, 1-1/2" *

*Stock items available in plumbing department

Call 800-991-0466, option 3 to order parts.

Part No.

- PHCC-2400-CON1
- DFC1
- S3033-GL
- 1011010
- 1113003
- 1120007
- 1125000
- 1143000
- 1806065
- BF
- 1100021
- 1200008
- 1120009
- 1122000
- 1122002
- 1141001
- 1142000

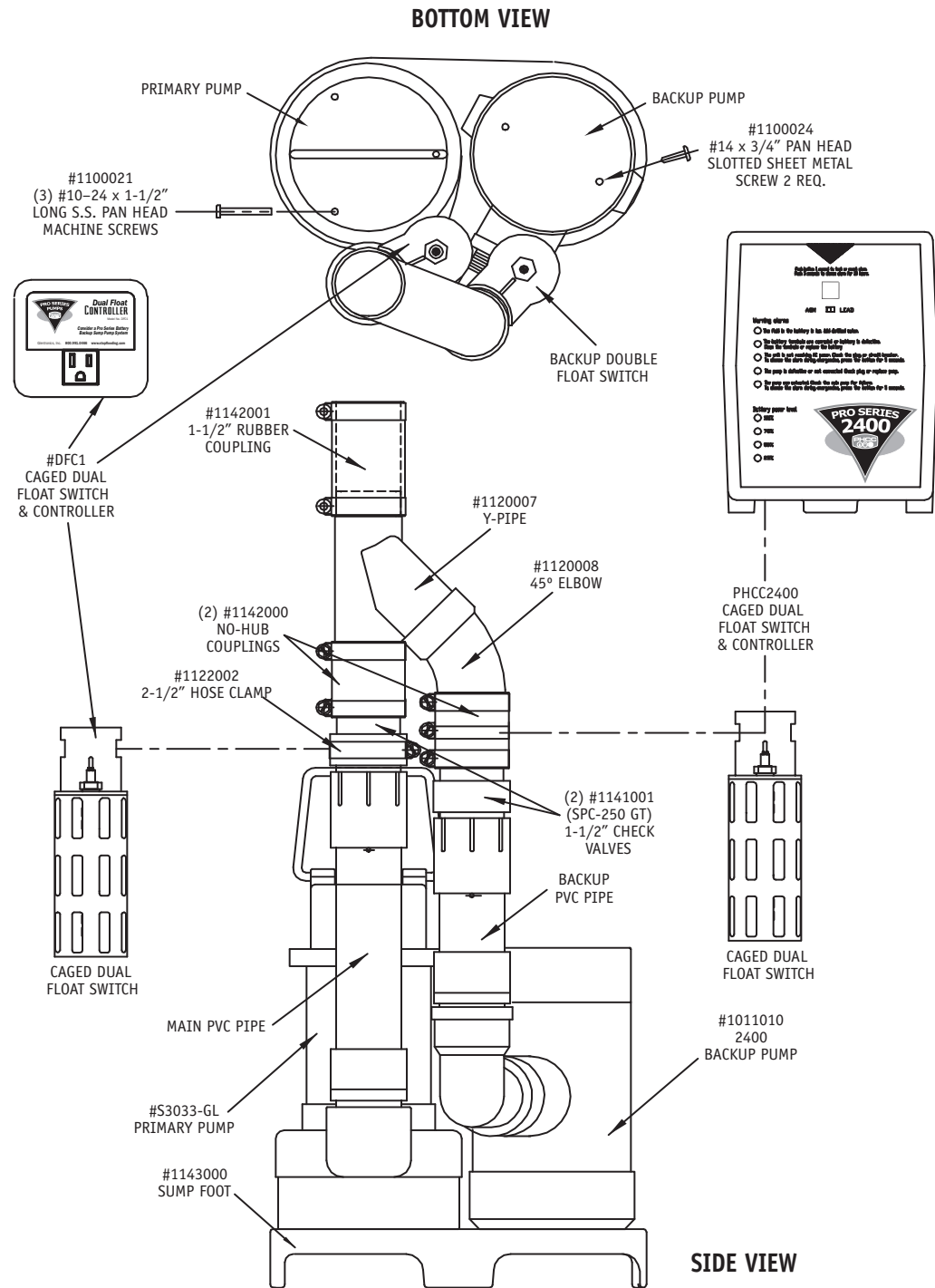

Primary Pump Troubleshooting Guide

⚠ DANGER

Read safety warnings & instructions before attempting any repairs or maintenance.

Potential Cause	THE PUMP WILL NOT START OR RUN	Solutions
Pump is not plugged in	Plug pump in properly (see instructions)	
No AC power	Check circuit breaker or fuse, and GFI reset button	
Poor power source	Check circuit line wires, cable and outlet	
Locked impeller	Remove strainer and clear obstruction	
Defective float switch	Replace float switch with new float switch	
Defective pump	Replace pump with new pump	
Potential Cause	THERMAL PROTECTOR TRIPPING OR NOT FUNCTIONING	Solutions
Locked impeller	Remove strainer and clear obstruction	
Incorrect power supply	Check power supply source and voltage	
Pump running continuously with no water present	Check float switch	
Potential Cause	PUMP STARTS AND STOPS TOO FREQUENTLY	Solutions
Float switches mounted too low	Raise both float switches	
Water back flowing from pipe	Install or replace check valve	
Malfunctioning float switch	Replace float switch with new float switch	
Potential Cause	PUMP WILL NOT SHUT OFF	Solutions
Clogged or frozen discharge	Clear blockage or thaw frozen line	
Blocked intake strainer	Clear debris from intake strainer	
One or both of the floats is obstructed and cannot drop down	Clear debris from inside the float cage (Loosen nut on top of float, then remove c-clip on bottom of float. Remove debris. Tighten nut on top of float, then replace c-clip on bottom of float.) When reassembling the float, the magnetic strip on the inside of the float should be facing down.	
Defective float switch	Replace float switch with new float switch	
Check valve is stuck	Replace check valve.	
Potential Cause	INSUFFICIENT OR NO WATER VOLUME	Solutions
Check valve on secondary pump will not close and water re-circulates within the system	Replace the check valve on the secondary pump	
Partially blocked impeller	Remove strainer and clear obstruction	
Clogged or frozen discharge pipe	Clear blockage or thaw frozen line	
Broken or leaking pipe	Repair pipe	
Low power voltage	Check power voltage, wires and cable condition	
Check valve is stuck	Replace check valve.	
There is an air lock in the system	Make sure the 1/8" air bleed hole located near the top of the PVC pipe is clear of debris	
Potential Cause	ABNORMAL SOUND OR VIBRATION	Solutions
Check valve is broken	Replace the check valve	
Blocked intake screen	Clear debris from intake screen	
Defective pump	Replace pump	

If the listed solutions do not resolve the problem, follow the instructions within the manual to disconnect the system from the outlet and battery terminals, then reconnect the system and push the reset button. If the problem continues, contact customer service at 800-991-0466 option 3.

Backup Pump Troubleshooting Guide

⚠ DANGER

Read safety warnings & instructions before attempting any repairs or maintenance.

Potential Cause	BATTERY FLUID LOW	Solutions
The battery fluid is low	Add distilled water to each cell of the battery	
The fluid sensor is installed improperly	The fluid sensor should be inserted into the designated hole on the top of the battery and pushed down	
Not using a Pro Series battery	This feature cannot be used. Attach the fluid sensor to the positive post of the battery	
Potential Cause	BATTERY PROBLEM	Solutions
Terminals are corroded	Clean terminals and cables	
Cables are loose	Tighten wing nuts	
Battery is discharged below 25%	Replace battery if power is out. There is only 1 hour of continuous pumping power left. Battery will recharge when power is restored	
Battery is old or damaged	Replace battery	
Potential Cause	POWER FAILURE	Solutions
Power outage	None. The backup pump will run off of the battery. Flip the alarm switch to the off position to silence the alarm. Be sure to flip it back to on when the power is restored.	
An outlet, fuse, or circuit breaker has failed	Try another outlet, replace the fuse, or reset the circuit breaker	
The charger is unplugged from the wall or the back of the controller	Make sure the power cord is plugged in securely	
The control unit is receiving less than 110 volts from the outlet	None, if the utility company has instigated brown outs. Otherwise, reduce the number of other appliances on the circuit	
Potential Cause	PUMP WILL NOT SHUT OFF	Solutions
Backup pump is unplugged	Make sure the pump is securely plugged into the back of the control unit	
Backup pump is clogged	Remove strainer from pump and clean out any debris	
Backup pump is broken	Replace the pump	
Potential Cause	INSUFFICIENT OR NO WATER VOLUME	Solutions
The main AC pump failed because of a power outage	None. The backup pump was activated when needed	
The water was coming into the sump faster than the main pump could evacuate it	None. The backup pump was activated when needed	
The float switch on the main AC pump is stuck or defective	Free the float switch on the main pump or replace it	
The main AC pump is broken	Replace the main AC pump	
The main AC pump could not keep up with the inflow of water	None. The backup pump was activated as needed. If this is a recurring problem, install a higher capacity main pump	
The check valve is stuck and the water cannot pass through it	Replace the check valve	
The discharge pipe is clogged or frozen and the water cannot pass through it	Thaw, clean out the blockage, or replace the discharge pipe	
There is a slight chance of false activation if the float switch cord is wrapped around the AC power cord	Move the float switch cord away from the AC power cord	
There is an air lock in the system	Make sure the 1/8" air bleed hole located near the top of the PVC pipe is clear of debris	
Potential Cause	ABNORMAL SOUND OR VIBRATION	Solutions
Check valve is broken	Make sure check valve is functioning, or replace it	
Discharge pipe is clogged or frozen	Clear the discharge pipe	

Limited Warranty

GLETRONICS, INC. warrants to the original retail purchaser that all of its pump, switch, sensor, battery box and control unit products are free from defective materials and workmanship for the period indicated below:

All parts and labor (excluding installation) for a period of
three (3) years from the date of purchase

The defective product must be returned directly to the factory, postage prepaid with the original bill of sale or receipt to the address listed below. Glentronics, Inc., at its option, will either repair or replace the product and return it postage prepaid.

CONDITIONS

The unit must be shipped freight prepaid, or delivered, to Glentronics, Inc. to provide the services described hereunder in either its original carton and inserts, or a similar package affording an equal degree of protection.

The unit must not have been previously altered, repaired or serviced by anyone other than Glentronics, Inc., or its agent; the serial number on the unit must not have been altered or removed; the unit must not have been subject to accident, misuse, abuse or operated contrary to the instructions contained in the accompanying manual.

The dealer's dated bill of sale, or retailer's receipt, must be retained as evidence of the date of purchase and to establish warranty eligibility.

This warranty does not cover product problems resulting from handling liquids hotter than 120 degrees Fahrenheit, handling inflammable liquids, solvents, strong chemicals or severe abrasive solutions; normal wear; user abuse; misuse, neglect, improper maintenance, commercial or industrial use; improper connections or installation; damages caused by lightning strikes, excessive surges in AC line voltage, water damage to the controller, other acts of nature, or failure to operate in accordance with the enclosed written instructions.

GLETRONICS, INC. WILL NOT BE LIABLE FOR ANY INCIDENTAL, SPECIAL OR CONSEQUENTIAL DAMAGES FOR BREACH OF ANY EXPRESS OR IMPLIED WARRANTIES ON THIS PRODUCT. SOME STATES DO NOT ALLOW THE EXCLUSION OR LIMITATION OF CONSEQUENTIAL OR INDIRECT DAMAGES, SO THE ABOVE LIMITATION MAY NOT APPLY TO YOU. THIS EXPRESS WARRANTY SHALL BE EXCLUSIVE AND IS IN LIEU OF ALL OTHER WARRANTIES, WRITTEN OR ORAL, EXPRESS OR IMPLIED, INCLUDING, BUT NOT LIMITED TO ANY WARRANTY OF MERCHANTABILITY OR FITNESS FOR A PARTICULAR PURPOSE. THE CUSTOMER'S EXCLUSIVE REMEDY FOR BREACH OF THIS WARRANTY, OR OF ANY IMPLIED WARRANTY NOT EXCLUDED HEREIN, SHALL BE LIMITED TO REPAIR OR REPLACEMENT OF THE PRODUCT.

For information or service contact:

Glentronics, Inc.
640 Heathrow Drive
Lincolnshire, IL 60069
800-991-0466

Model # PS-C33 Serial # _____ Purchase Date _____

Register online at www.stopflooding.com

CHECK OUT THIS OTHER PHCC PRO SERIES PRODUCT

WATER ALARM

Minimize the risk of water damage

You can detect leaks before they become bigger problems by placing a water alarm wherever there is a risk of water damage...in the utility room, laundry room, kitchen, bathroom or basement. The alarm will sound when as little as 1/32" of water reaches the sensor.

