



Thinking of you
Electrolux



EMS26204O

.....
GB MICROWAVE OVEN

USER MANUAL

CONTENTS

SAFETY INFORMATION 3

PRODUCT DESCRIPTION 7

CONTROL PANEL 8

BEFORE FIRST USE 8

OPERATION 10

PROGRAMME CHARTS 17

RECIPES 23

CARE AND CLEANING 28

TROUBLESHOOTING 30

TECHNICAL INFORMATION 30

INSTALLATION 31

ENVIRONMENT CONCERNS 33

GUARANTEE/CUSTOMER SERVICE 33

WE'RE THINKING OF YOU

Thank you for purchasing an Electrolux appliance. You've chosen a product that brings with it decades of professional experience and innovation. Ingenious and stylish, it has been designed with you in mind. So whenever you use it, you can be safe in the knowledge that you'll get great results every time.

Welcome to Electrolux.

Visit our website for:



Get usage advice, brochures, trouble shooter, service information:
www.electrolux.com



Register your product for better service:
www.electrolux.com/productregistration



Buy Accessories, Consumables and Original spare parts for your appliance:
www.electrolux.com/shop

CUSTOMER CARE AND SERVICE

We recommend the use of original spare parts.
When contacting Service, ensure that you have the following data available.
The information can be found on the rating plate. Model, PNC, Serial Number.

 Warning/Caution-Safety information

 General information and tips

 Environmental information

Subject to change without notice.

SAFETY INFORMATION



IMPORTANT SAFETY INSTRUCTIONS: READ CAREFULLY AND KEEP FOR FUTURE REFERENCE

To avoid the danger of fire

The microwave oven should not be left unattended during operation.

Power levels that are too high or cooking times that are too long may overheat foods resulting in a fire.

The electrical outlet must be readily accessible so that the unit can be unplugged easily in an emergency.

It is recommended that a separate circuit serving only this appliance be provided.

Do not store or use the oven outdoors.

If food being heated begins to smoke, DO NOT OPEN THE DOOR. Turn off and unplug the oven and wait until the food has stopped smoking. Opening the door while food is smoking may cause a fire.

Only use microwave-safe containers and utensils. Do not leave the oven unattended when using disposable plastic, paper or other combustible food containers.

Clean the waveguide cover, the oven cavity, the turntable and turntable support after use. These must be dry and free from grease. Built-up grease may overheat and begin to smoke or catch fire.

Do not place flammable materials near the oven or ventilation openings. Do not block the ventilation openings.

Remove all metallic seals, wire twists, etc., from food and food packages. Arcing on metallic surfaces may cause a fire.

Do not use the microwave oven to heat oil for deep frying. The temperature cannot be controlled and the oil may catch fire.

To make popcorn, only use special microwave popcorn makers.

Do not store food or any other items inside the oven. Check the settings after you start the oven to ensure the oven is operating as desired.

See the corresponding hints in this operation manual.

To avoid the possibility of injury



WARNING! Do not operate the oven if it is damaged or malfunctioning. Check the following before use:

- a) **The door; make sure the door closes properly and ensure it is not misaligned or warped.**
- b) **The hinges and door safety latches; check to make sure they are not broken or loose.**
- c) **The door seals and sealing surfaces; ensure that they have not been damaged.**
- d) **Inside the oven cavity or on the door; make sure there are no dents.**
- e) **The power supply cord and plug; ensure that they are not damaged.**

Never adjust, repair or modify the oven yourself. It

is hazardous for anyone other than a competent person to carry out any service or repair operation which involves the removal of a cover which gives protection against exposure to microwave energy.

Do not operate the oven with the door open or alter the door safety latches in any way.

Do not operate the oven if there is an object between the door seals and sealing surfaces.

Do not allow grease or dirt to build up on the door seals and adjacent parts. Follow the instructions for “Care & cleaning”. Failure to maintain the oven in a clean condition could lead to a deterioration of the surface that could adversely affect the life of the appliance and possibly result in a hazardous situation.

Individuals with PACEMAKERS should check with their doctor or the manufacturer of the pacemaker for precautions regarding microwave ovens.

To avoid the possibility of electric shock
Under no circumstances should you remove the outer cabinet.

Never spill or insert any objects into the door lock openings or ventilation openings. In the event of a spill, turn off and unplug the oven immediately and call your local Service Force Centre.

Do not immerse the power supply cord or plug in water or any other liquid. Do not allow the power supply cord to run over any hot or sharp surfaces, such as the hot air vent area at the top rear of the oven.

Do not attempt to replace the oven lamp yourself or allow anyone who is not

authorised by Service Force to do so. If the oven lamp fails, please consult your dealer or contact your local Service Force Centre.

If the power supply cord of this appliance is damaged, it must be replaced with a special cord. The exchange must be made by an authorised Service Force technician.

To avoid the possibility of explosion and sudden boiling

⚠ WARNING! Liquids and other foods must not be heated in sealed containers since they are liable to explode.

Never use sealed containers. Remove seals and lids before use. Sealed containers can explode due to a build up of pressure even after the oven has been turned off.

Take care when microwaving liquids. Use a wide-mouthed container to allow bubbles to escape.

Microwave heating of beverages can result in delayed eruptive boiling, therefore care has to be taken when handling the container.

To prevent sudden eruption of boiling liquid and possible scalding:

1. Stir liquid prior to heating/reheating.
2. It is advisable to insert a glass rod or similar utensil into the liquid whilst reheating.
3. Let liquid stand for at least 20 seconds in the oven at the end of cooking time to prevent delayed eruptive boiling.

Do not cook eggs in their shells and whole hard boiled eggs should not be heated in microwave ovens since they may explode even after microwave cooking has ended. To cook or reheat

eggs which have not been scrambled or mixed, pierce the yolks and the whites, or the eggs may explode. Shell and slice hard boiled eggs before reheating them in the microwave oven.

Pierce the skin of such foods as potatoes, sausages and fruit before cooking, or they may explode.

To avoid the possibility of burns

Use pot holders or oven gloves when removing food from the oven to prevent burns.

Always open containers, popcorn makers, oven cooking bags, etc., away from the face and hands to avoid steam burns.

To avoid burns, always test food temperature and stir before serving and pay special attention to the temperature of food and drink given to babies, children or the elderly.

Temperature of the container is not a true indication of the temperature of the food or drink; always check the food temperature.

Always stand back from the oven door when opening to avoid burns from escaping steam and heat. Slice stuffed baked foods after heating to release steam and avoid burns.

Keep children away from the door and accessible parts that may become hot when the grill is in use. Children should be kept away to prevent them burning themselves.

Do not touch the oven door, outer cabinet, rear cabinet, oven cavity, ventilation openings, accessories and dishes during GRILL mode,

DUAL GRILL mode and AUTO COOK operation as they will become hot. Before cleaning make sure they are not hot.

To avoid misuse by children



WARNING! The appliance and its accessible parts become hot during use. Care should be taken to avoid touching heating elements. Children less than 8 years of age shall be kept away unless continuously supervised.

This appliance can be used by children aged from 8 years and above and persons with reduced physical, sensory or mental capabilities or lack of experience and knowledge if they have been given supervision or instruction concerning use of the appliance in a safe way and understand the hazards involved. Children should be supervised to ensure that they do not play with the appliance. Cleaning and user maintenance shall not be made by children unless they are aged from 8 years and above and supervised.

Do not lean or swing on the oven door. Do not play with the oven or use it as a toy. Children should be taught all important safety instructions: use of pot holders, careful removal of food coverings; paying special attention to packaging (e.g. self-heating materials) designed to make food crisp, as they may be extra hot.

Other warnings

Never modify the oven in any way. This oven is for home food preparation only and may only be used for cooking food. It is not suitable for commercial or laboratory use.

To promote trouble-free use of your oven and avoid damage

Never operate the oven when it is empty except where recommended in the operation manual, see page 14 note 2. Doing so may damage the oven.

When using a browning dish or self-heating material, always place a heat-resistant insulator such as a porcelain plate under it to prevent damage to the turntable and turntable support due to heat stress. The preheating time specified in the dish's instructions must not be exceeded.

Do not use metal utensils, which reflect microwaves and may cause electrical arcing. Do not put cans in the oven.

Only use the turntable and the turntable support designed for this oven. Do not operate the oven without the turntable.

To prevent the turntable from breaking:

- a) Before cleaning the turntable with water, leave the turntable to cool.
- b) Do not put hot foods or hot utensils on a cold turntable.
- c) Do not put cold foods or cold utensils on a hot turntable.

Do not place anything on the outer cabinet during operation. Do not use plastic containers for microwaving if the oven is still hot from using the GRILL mode, DUAL GRILL mode and AUTO COOK operation because they may melt. Plastic containers must not be used during above modes unless the container manufacturer says they are suitable.

Important!

If you are unsure how to connect your oven, please consult an authorised, qualified electrician.

Neither the manufacturer nor the dealer can accept any liability for damage to the oven or personal injury resulting from failure to observe the correct electrical connection procedure. Water vapour or drops may occasionally form on the oven walls or around the door seals and sealing surfaces. This is a normal occurrence and is not an indication of microwave leakage or a malfunction.

PRODUCT DESCRIPTION

MICROWAVE OVEN AND ACCESSORIES

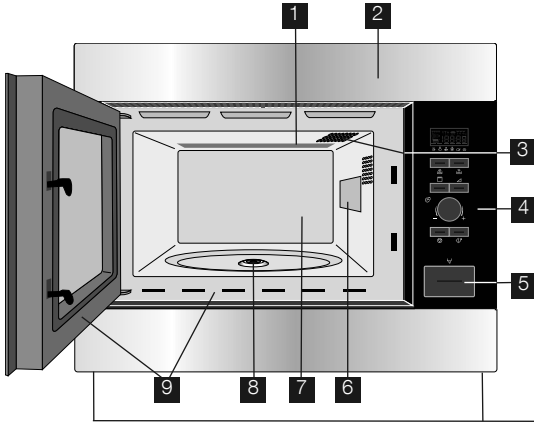

- 1 Grill heating element
- 2 Front trim
- 3 Oven lamp
- 4 Control panel
- 5 Door opening button
- 6 Waveguide cover
- 7 Oven cavity
- 8 Seal packing
- 9 Door seals and sealing surfaces

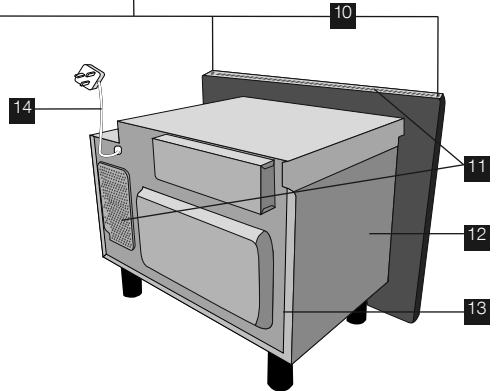

Check to make sure the following accessories are provided:

- 1 Turntable
- 2 Turntable support
- 3 High rack
- 4 Low rack
- 5 4 fixing screws (not shown)

- Place the turntable support in the seal packing on the floor of the cavity.
- Then place the turntable on the turntable support.
- To avoid turntable damage, ensure dishes or containers are lifted clear of the turntable rim when removing them from the oven.

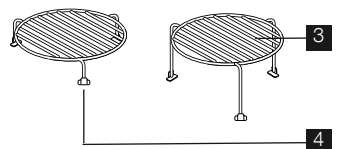
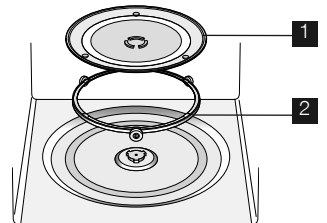

! Important!

When you order accessories, please mention two items: part name and model name to your dealer or local Service

CONTROL PANEL

1 DIGITAL DISPLAY indicators



Grill



Plus/Minus



Microwave



Auto defrost bread



Dual



Auto defrost



Clock



Weight



Cooking stages

2 AUTO COOK indicators

3 AUTO COOK button

4 AUTO DEFROST button

5 POWER LEVEL button

6 GRILL button

7 TIMER/WEIGHT knob

8 START/+30 button

9 STOP button

10 DOOR OPENING button

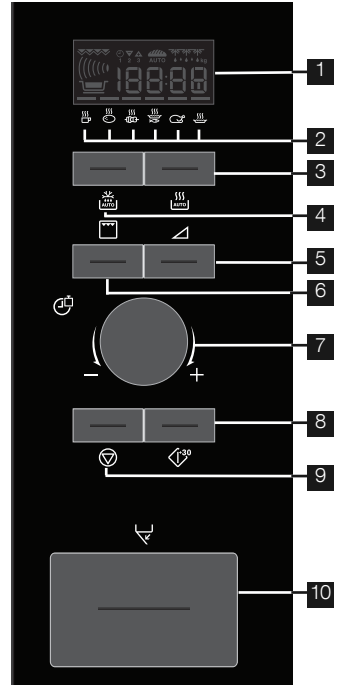

BEFORE FIRST USE

ECON MODE

The oven is set in 'ENERGY SAVE' mode ("Econ").

1. Plug in the oven.
2. The display will show: 'Econ'.
3. The display will count down from 3:00 to zero.
4. When zero is reached, the oven goes into 'Econ' mode and the display goes blank.



- To cancel Econ mode, set the clock.

SETTING THE CLOCK

The oven has a 12 and 24 hour clock.

Example: To set the clock to 11:30 (12 hour clock).



1. Open the door.
2. The display will show: 'Econ'.
3. Press and hold the START/+30 button for 5 seconds. The oven will beep. The display will show:

4. Rotate the TIMER/WEIGHT knob to adjust the hour.
5. Press the START/+30 button once then rotate the TIMER/WEIGHT knob to adjust the minutes.
6. Press the START/+30 button.
7. Check the display:
8. Close the door.



- You can rotate the TIMER/WEIGHT knob clockwise or anti-clockwise.
- If you press the STOP button the clock will not be set. The display will show: 'Econ'.

Example: To set the clock to 23:30 (24 hour clock).

1. Open the door.
2. The display will show: 'Econ'.
3. Press and hold the START/+30 button for 5 seconds. The oven will beep. The display will show: 
4. Press the START/+30 button. The display will show: 
5. Rotate the TIMER/WEIGHT knob to adjust the hour.
6. Press the START/+30 button once then rotate the TIMER/WEIGHT knob to adjust the minutes.
7. Press the START/+30 button.
8. Check the display: 
9. Close the door.



- You can rotate the TIMER/WEIGHT knob clockwise or anti-clockwise.
- If you press the STOP button the clock will not be set. The display will show: 'Econ'.

ADJUSTING THE TIME WHEN THE CLOCK IS SET

Example: To set the clock to 11:45 (12 hour clock).

1. Open the door.
2. Press and hold the START/+30 button for 5 seconds. The oven will beep. The display will show: 

(If you want to change the clock to 24 H, press the START/+30 button again.)

3. Rotate the TIMER/WEIGHT knob to adjust the hour.
4. Press the START/+30 button once then rotate the TIMER/WEIGHT knob to adjust the minutes.
5. Press the START/+30 button.
6. Check the display: 

TO CANCEL THE CLOCK AND SET ECON MODE

1. Open the door.
2. Press and hold the START/+30 button for 5 seconds. The oven will beep. The display will show: 

(If you want to change the clock to 24 H, press the START/+30 button again.)

3. Press the STOP button.
4. The display will show: 'Econ'.
5. Close the door.
6. The oven will count down from 3:00 to zero.
7. When zero is reached, the oven goes into Econ mode and the display goes blank.

USING THE STOP BUTTON

Use the STOP button to:

1. Erase a mistake during programming.
2. Stop the oven temporarily during cooking, press once.
3. Cancel a programme during cooking, press twice.



CHILD SAFETY LOCK

The oven has a safety feature which prevents the accidental running of the oven by a child. When the lock has been set, no part of the microwave will operate until the lock feature has been cancelled.

Example: To set the child safety lock.

1. Press and hold the STOP button for 5 seconds.



The oven will beep twice and 'LOC' will be displayed: 



- To cancel the child safety lock, press and hold the STOP button for 5 seconds, the oven will beep twice and the time of day will be displayed.
- Child safety lock cannot be set if the clock is not set.

OPERATION

MICROWAVE COOKING ADVICE

To cook/defrost food in a microwave oven, the microwave energy must be able to pass through the container to penetrate the food. Therefore it is important to choose suitable cookware.

Round/oval dishes are preferable to square/oblong ones, as the food in the corners tends to overcook.

It is important to turn, rearrange or stir food to ensure even heating.

Standing time is necessary after cooking, as it enables the heat to disperse equally throughout the food.

Food characteristics

Composition	Foods high in fat or sugar (e.g. Christmas pudding, mince pies) require less heating time. Care should be taken as overheating can lead to fire.
Density	Food density will affect the amount of cooking time needed. Light porous foods, such as cakes or bread, cook more quickly than heavy, dense foods, such as roasts and casseroles.
Quantity	The cooking time must be increased as the amount of food placed in the oven increases (e.g. four potatoes will take longer to cook than two).
Size	Small foods and small pieces cook faster than large ones, as microwaves can penetrate from all sides to the centre. For even cooking make all the pieces the same size.
Shape	Foods which are irregular in shape, such as chicken breasts or drumsticks, take longer to cook in the thicker parts. Round shapes cook more evenly than square shapes when microwave cooking.
Temperature of food	The initial temperature of food affects the amount of cooking time needed. Chilled foods will take longer to cook than food at room temperature. Cut into foods with fillings (e.g. jam doughnuts) to release heat or steam.

Cooking techniques

Arrange	Place the thickest parts of food towards the outside of the dish (e.g. chicken drumsticks).
Cover	Use vented microwave cling film or a suitable lid.
Pierce	Foods with a shell, skin or membrane must be pierced in several places before cooking or reheating as steam will build up and may cause food to explode (e.g. potatoes, fish, chicken, sausages). ⚠ Important! Eggs should not be heated using microwave power as they may explode, even after cooking has ended (e.g. poached, hard boiled).
Stir, turn and rearrange	For even cooking it is essential to stir, turn and rearrange food during cooking. Always stir and rearrange from the outside towards the centre.
Stand	Standing time is necessary after cooking to enable the heat to disperse equally throughout the food.
Shield	Some areas of food being defrosted may become warm. Warm areas can be shielded with small pieces of foil, which reflect microwaves (e.g. legs and wings on a chicken).

MICROWAVE SAFE COOKWARE

Cookware	Microwave safe	Comments
Aluminium foil/containers	✓/✗	Small pieces of aluminium foil can be used to shield food from overheating. Keep foil at least 2 cm from the oven walls, as arcing may occur. Foil containers are not recommended unless specified by the manufacturer. Follow instructions carefully.
Browning dishes	✓	Always follow the manufacturer's instructions. Do not exceed heating times given. Be very careful as these dishes become very hot.
China and ceramics	✓/✗	Porcelain, pottery, glazed earthenware and bone china are usually suitable, except for those with metallic decoration.
Glassware e.g. Pyrex®	✓	Care should be taken if using fine glassware as it can break or crack if heated suddenly.
Metal	✗	It is not recommended to use metal cookware when using microwave power as it will arc, which can lead to fire.
Plastic/polystyrene e.g. fast food containers	✓	Care must be taken as some containers warp, melt or discolour at high temperatures.
Cling film	✓	Should not touch the food and must be pierced to let the steam escape.
Freezer/roasting bags	✓	Must be pierced to let steam escape. Ensure bags are suitable for microwave use. Do not use plastic or metal ties, as they may melt or catch fire due to the metal arcing.
Paper - plates, cups and kitchen paper	✓	Only use for warming or to absorb moisture. Care must be taken as overheating may cause fire.
Straw and wooden containers	✓	Always attend the oven when using these materials as overheating may cause fire.
Recycled paper and newspaper	✗	May contain extracts of metal which will cause arcing and may lead to fire.

MICROWAVE COOKING

Your oven can be programmed for up to 90 minutes. The input unit of cooking time varies from 15 seconds to five minutes. It depends on the total length of the cooking time as shown in the table.

Cooking time	Increasing unit
0-5 minutes	15 seconds
5-10 minutes	30 seconds
10-30 minutes	1 minute
30-90 minutes	5 minutes

MANUAL DEFROSTING

For manual defrosting (without operating the Auto Defrost feature), use 270 W. The defrost symbol appears in the window display whenever the power level is selected.

MICROWAVE POWER LEVELS

Your oven has 6 power levels:

Power setting	Suggested use
900 W/HIGH	Used for fast cooking or reheating (e.g. soup, casseroles, canned food, hot beverages, vegetables, fish).
630 W	Used for longer cooking of dense foods such as roast joints, meat loaf and plated meals, also for sensitive dishes such as cheese sauce and sponge cakes. At this reduced setting, the sauce will not boil over and food will cook evenly without over cooking at the sides.
450 W	For dense foods which require a long cooking time when cooked conventionally (e.g. beef dishes) it is advisable to use this power setting to ensure the meat will be tender.
270 W/ DEFROST	To defrost, select this power setting, to ensure that the dish defrosts evenly. This setting is also ideal for simmering rice, pasta, dumplings and cooking egg custard.
90 W	For gentle defrosting (e.g. cream gateaux or pastry).
0 W	For standing/kitchen timer.

W = WATT

Example: To heat soup for 2 minutes and 30 seconds on 630 W microwave power.

1. Press the POWER LEVEL button twice.



2. Enter the time by rotating the TIMER/WEIGHT knob clockwise/anti-clockwise until 2.30 is displayed.



3. Press the START/+30 button.

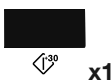

4. Check the display:

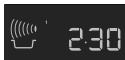

- When the door is opened during the cooking process, the cooking time on the digital display stops automatically. The cooking time starts to count down again when the door is closed and the START/+30 button is pressed.
- If you wish to know the power level during cooking, press the POWER LEVEL button once.
- You can increase or decrease the cooking time during cooking by rotating the TIMER/WEIGHT knob.
- You can change the power level during cooking by pressing the POWER LEVEL button.
- To cancel a programme during cooking, press the STOP button twice.

Important!

If the power level is not selected, 900 W/HIGH is automatically set.

KITCHEN TIMER

Example: To set the kitchen timer for 7 minutes.

1. Press the POWER LEVEL button 7 times.



2. Enter the time by rotating the TIMER/WEIGHT knob clockwise/anti-clockwise until 7.00 is displayed.



3. Press the START/+30 button.



4. Check the display:



- To pause the timer, press the STOP button. To resume the timer press START/+30, to exit press STOP again.

ADD 30 SECONDS

The START/+30 button allows you to operate the two following functions:

1. Direct Start

You can directly start cooking on 900 W/ HIGH microwave power level for 30 seconds by pressing the START/+30 button.



2. Extend the cooking time

You can extend the cooking time for multiples of 30 seconds if the button is pressed while the oven is in operation.



- You can also use +30 seconds during grill mode.
- You cannot use this function during AUTO COOK or AUTO DEFROST.

PLUS AND MINUS

The PLUS \triangle and MINUS ∇ function enables you to decrease or increase the cooking time when using the automatic programmes.

If you prefer boiled potatoes which are cooked but still firm, use MINUS ∇ . Alternatively, if you prefer boiled potatoes softer, use PLUS \triangle .

Example: To cook 0.3 kg of boiled potatoes, well done.

1. Select the menu required by pressing the AUTO COOK button twice.



2. Turn the TIMER/WEIGHT knob until 0.3 is displayed.



3. Press the POWER LEVEL button once to select the PLUS \triangle adjustment.



4. Press the START/+30 button.

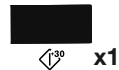

5. Check the display:



- To cancel PLUS/MINUS, press the POWER LEVEL button 3 times.
- If you select PLUS, the display will show \triangle .
- If you select MINUS, the display will show ∇ .

GRILL AND DUAL GRILL COOKING

This microwave oven has two GRILL cooking modes:

1. Grill only
2. Dual Grill (grill with microwave)

⚠ Important!

1. The high or the low rack is recommended for grilling.
2. You may detect smoke or a burning smell when using the grill for the first time, this is normal and does not indicate a fault with the oven. To avoid this problem, when using the grill for the first time, operate the grill without food for 20 minutes.

1. Grill only cooking

This mode can be used to grill/brown food.

Example: To make toast for 4 minutes.

1. Press the GRILL button once.



2. Enter the time by rotating the TIMER/WEIGHT knob clockwise/anti-clockwise until 4.00 is displayed.



3. Press the START/+30 button.



4. Check the display:

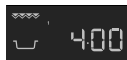

2. Dual grill cooking

This mode uses a combination of grill power and microwave power (90 W to 630 W). The microwave power level is preset to 270 W.

Button	Power setting
Grill x 1	0 W
Grill x 2	270 W
Grill x 3	450 W
Grill x 4	630 W
Grill x 5	0 W

Example: To cook grill skewers for 7 minutes on DUAL GRILL (450 W).

1. Press the GRILL button 3 times.



2. Enter the time by rotating the TIMER/WEIGHT knob clockwise/anti-clockwise until 7.00 is displayed.



3. Press the START/+30 button.



4. Check the display:



MULTIPLE SEQUENCE COOKING

A sequence of 3 stages (maximum) can be programmed using MICROWAVE, GRILL OR DUAL GRILL.

Example: To cook:

2 minutes and 30 seconds on

630 W power (Stage 1)

5 minutes grill only (Stage 2)

Stage 1

1. Press the POWER LEVEL button twice.



2. Enter the desired time by rotating the TIMER/WEIGHT knob clockwise until 2.30 is displayed.



3. Check the display:

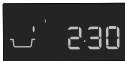

Stage 2

1. Press the GRILL button once.



2. Enter the desired time by rotating the TIMER/WEIGHT knob clockwise until 5.00 is displayed.



3. Press the START/+30 button.



4. Check the display:



The oven will begin to cook for 2 minutes and 30 seconds at 630 W and then for 5 minutes on grill only.

AUTO COOK AND AUTO DEFROST

AUTO COOK and AUTO DEFROST automatically works out the correct cooking mode and cooking time. You can choose from 6 AUTO COOK and 2 AUTO DEFROST menus.

Auto Cook

Food	Symbol	Setting
Beverage		Microwave
Boiled potatoes/ Jacket potatoes		Microwave
Grilled skewers		Microwave + grill
Gratinated fish fillet		Microwave + grill
Grilled chicken		Microwave + grill
Gratin		Microwave + grill

Example: To cook 0.3 kg of boiled potatoes.

1. Select the menu required by pressing the AUTO COOK button twice.



2. Turn the TIMER/WEIGHT knob until 0.3 is displayed.



3. Press the START/+30 button.





4. Check the display:



When action is required (e.g. to turn food over) the oven stops and the audible bell sounds, remaining cooking time and the indicator will flash on the display. To continue cooking, press the START/+30 button. At the end of the AUTO COOK time, the programme will automatically stop. The audible bell sounds and the cooking symbol will flash. After 1 minute and a reminder beep, the time of day will be displayed.

Auto Defrost

Food	Symbol
Meat/fish/poultry	
Bread	

Example: To defrost 0.2 kg of bread.

1. Select the menu required by pressing the AUTO DEFROST button twice.



2. Turn the TIMER/WEIGHT knob until 0.2 is displayed.



3. Press the START/+30 button.









4. Check the display:



When action is required (e.g. to turn food over) the oven stops and the audible bell sounds, remaining cooking time and the indicator will flash on the display. To continue cooking, press the START/+30 button. At the end of the AUTO DEFROST time, the programme will automatically stop. The audible bell sounds and the cooking symbol will flash. After 1 minute and a reminder beep, the time of day will be displayed.

PROGRAMME CHARTS





AUTO COOK AND AUTO DEFROST CHARTS

Auto cook	Weight (increasing unit)/Utensils	Button	Procedure
Beverage (Tea/Coffee)	1-6 cups 1 cup = 200 ml	 x1	<ul style="list-style-type: none"> Place cup towards edge of turntable.
Boiled and jacket potatoes	0.2-1.0 kg (100 g) Bowl and lid	 x2	<p>Boiled potatoes: Peel the potatoes and cut them into similar sized pieces.</p> <p>Jacket potatoes: Choose potatoes of similar size and wash them.</p> <ul style="list-style-type: none"> Put the boiled or jacket potatoes into a bowl. Add the required amount of water, approx. 2 tbsp per 100 g and a little salt. Cover with lid. When the audible bell sounds, stir and re-cover. After cooking, stand for approx. 2 min.
Grilled skewers	0.2-0.8 kg (100 g) High rack	 x3	<ul style="list-style-type: none"> See recipe for 'Grilled skewers' on page 19. Place on the high rack and cook. When the audible bell sounds, turn over. After cooking, remove and put on a plate for serving.
Gratinated fish fillet	0.5-1.5 kg* (100 g) Gratin dish Low rack	 x4	<ul style="list-style-type: none"> See recipes for 'Gratinated fish fillet' on page 19.
Grilled chicken	0.9-1.8 kg (100 g) Flan dish Low rack	 x5	<ul style="list-style-type: none"> Mix together 2 tbsp oil, 1 tsp paprika, salt and pepper and spread on the chicken. Pierce the skin of the chicken. Put the chicken breast side down in a flan dish. Place on the low rack and cook. When audible bell sounds, turn over. After cooking, leave for approx. 3 min in the oven, remove and put on a plate for serving.
Gratin	0.5-1.5 kg* (100 g) Gratin dish Low rack	 x6	<ul style="list-style-type: none"> See recipes for 'Gratin' on page 20.

* Total weight of all ingredients.

* Total weight of all ingredients.

 Chilled foods are cooked from 5 °C, frozen foods are cooked from -18 °C.

Auto defrost	Weight (increasing unit)/Utensils	Button	Procedure
Meat/fish/poultry  (Whole fish, fish steaks, fish fillets, chicken legs, chicken breast, minced meat, steak, chops, burgers, sausages)	0.2-1.0 kg (100 g) Flan dish	 x1	<ul style="list-style-type: none"> Place the food in a flan dish in the centre of the turntable. When the audible bell sounds, turn the food over, rearrange and separate. Shield thin parts and warm spots with aluminium foil. After defrosting, wrap in aluminium foil for 15-45 min, until thoroughly defrosted. Minced meat: When the audible bell sounds, turn the food over. Remove the defrosted parts if possible. <p>i Not suitable for whole poultry.</p>
Bread  	0.1-1.0 kg (100 g) Flan dish	 x2	<ul style="list-style-type: none"> Distribute in a flan dish in the centre of the turntable. For 1.0 kg, distribute directly on the turntable. When the audible bell sounds, turn over, rearrange and remove defrosted slices. After defrosting cover in aluminium foil and stand for 5-15 min until thoroughly defrosted.

i Chilled foods are cooked from 5 °C, frozen foods are cooked from -18 °C.

- i**
- Enter the weight of the food only. Do not include the weight of the container.
 - For food weighing more or less than weights/quantities given in the Auto cook and defrost charts, use manual operation.
 - The final temperature will vary according to the initial temperature. Check food is piping hot after cooking.
 - When action is required (e.g. to turn food over) the oven stops and the audible bell sounds, remaining cooking time and the indicator will flash on the display. To continue cooking, press the START/ +30 button.
 - After Microwave/Grill/Dual Grill modes the cooling fan may come on.

- i** Auto defrost
- Steaks and chops should be frozen in one layer.
 - Minced meat should be frozen in a thin shape.
 - After turning over, shield the defrosted portions with small, flat pieces of aluminium foil.
 - The poultry should be processed immediately after defrosting.

RECIPES FOR AUTO COOK

Grilled skewers	
4 pieces	
400 g	pork cutlets, cubed
100 g	streaky bacon
100 g	onions, quartered
250 g	tomatoes, quartered
100 g	green pepper, cubed
2 tbsp	oil
4 tsp	paprika
	salt
1 tsp	cayenne pepper
1 tsp	Worcester sauce

Gratinated fish fillet 'Esterhazy'			
0.5 kg	1.0 kg	1.5 kg	
230 g	450 g	680 g	fish fillet
100 g	200 g	300 g	leeks (cut into rings)
20 g	40 g	60 g	onion (finely sliced)
40 g	100 g	140 g	carrot (grated)
10 g	15 g	20 g	butter or margarine
			salt, pepper and nutmeg
1 tbsp	1½ tbsp	2 tbsp	lemon juice
50 g	100 g	150 g	crème fraîche
50 g	100 g	150 g	Gouda, grated

Gratinated fish fillet 'Italian'			
0.5 kg	1.0 kg	1.5 kg	
200 g	430 g	630 g	fish fillet
½ tbsp	1 tbsp	1½ tbsp	lemon juice
½ tbsp	1 tbsp	1½ tbsp	anchovy butter
30 g	50 g	80 g	Gouda, grated
			salt and pepper
150 g	300 g	450 g	fresh tomatoes
1 tbsp	1½ tbsp	2 tbsp	chopped mixed herbs
100 g	180 g	280 g	Mozzarella
½ tbsp	¾ tbsp	1 tbsp	basil, chopped

1. Thread meat and vegetables alternately on 4 wooden skewers.
2. Mix the oil with the spices and brush over the kebabs.
3. Place the kebabs on the high rack and cook on AUTO COOK "Grilled skewers".

1. Put vegetables, butter and the spices into a casserole dish and mix well. Cook for 2-6 min on 900 W depending on weight.
2. Wash the fish, dry and sprinkle with lemon juice and salt.
3. Mix the crème fraîche with the vegetables and season again.
4. Put half of the vegetables in a gratin dish. Place the fish on top and cover with the remaining vegetables.
5. Spread the Gouda over the top, place on the low rack and cook on AUTO COOK "Gratinated fish fillet".
6. After cooking, stand for approx. 5 min.

1. Wash and dry the fish and sprinkle with lemon juice, salt and anchovy butter.
2. Place in a gratin dish.
3. Sprinkle the Gouda over the fish.
4. Place the tomatoes on top of the cheese.
5. Season with salt, pepper and the mixed herbs.
6. Drain the Mozzarella, cut into slices and place on the tomatoes. Sprinkle the basil over the cheese.
7. Place the gratin dish on the low rack and cook on AUTO COOK "Gratinated fish fillet".
8. After cooking, stand for approx. 5 min.

Spinach gratin			
0.5 kg	1.0 kg	1.5 kg	
150 g	300 g	450 g	leaf spinach, defrosted, drained
15 g	30 g	45 g	onion, finely chopped
			salt, pepper and nutmeg
5 g	10 g	15 g	butter or margarine to grease the dish
150 g	300 g	450 g	boiled potatoes, sliced
35 g	75 g	110 g	cooked ham, diced
50 g	100 g	150 g	crème fraîche
1	2	3	eggs
40 g	75 g	115 g	grated cheese

Potato and courgette gratin			
0.5 kg	1.0 kg	1.5 kg	
5 g	10 g	15 g	butter or margarine to grease the dish
200 g	400 g	600 g	boiled potatoes, sliced
115 g	230 g	345 g	courgette, finely sliced
75 g	150 g	225 g	crème fraîche
1	2	3	eggs
1/2	1	2	clove of garlic, crushed
			salt and pepper
40 g	80 g	120 g	Gouda, grated
10 g	20 g	30 g	sunflower kernels

1. Mix together the leaf spinach with the onion and season with salt, pepper and nutmeg.
2. Grease the gratin dish. Place alternate layers of potato slices, diced ham and spinach in the dish. The top layer should be spinach.
3. Mix the eggs with crème fraîche, add salt and pepper and pour over the gratin.
4. Cover the gratin with the grated cheese.
5. Place on the low rack and cook on AUTO COOK "Gratin".
6. After cooking, stand for 5-10 min.

1. Grease the gratin dish and place alternate layers of potato slices and courgette in the dish.
2. Mix the eggs with crème fraîche, season with salt, pepper and garlic and pour over the gratin.
3. Sprinkle the Gouda cheese over the gratin.
4. Finally sprinkle the gratin with sunflower kernels.
5. Place on the low rack and cook on AUTO COOK "Gratin".
6. After cooking, stand for 5-10 min.

REDUCED POWER LEVEL

Important!

If you cook the food over the standard time with only the same cooking mode, the power of the oven will lower automatically to avoid

overheating (the microwave power level will be reduced or the grill heating element will begin to light on and off). After pausing for 90 seconds, full power can be reset.

Cooking mode	Standard time	Reduced power level
Microwave 900 W	20 minutes	Microwave 630 W
Grill	20 minutes	Grill - 50%
Dual Grill	Grill - 20 minutes	Grill - 50%

COOKING CHARTS

Abbreviations used				
tblsp = tablespoon	cup = cupful	g = gram	ml = millilitre	min = minutes
tsp = teaspoon	kg = kilogram	l = litre	cm = centimetre	

Heating food and drink

Food/drink	Quantity -g/ml-	Setting	Power Level	Time -Min-	Method
Milk, 1 cup	150	Micro	900 W	approx. 1	do not cover
Water, 1 cup 6 cups 1 bowl	150	Micro	900 W	approx. 2	do not cover
	900	Micro	900 W	8-10	do not cover
	1000	Micro	900 W	9-11	do not cover
One plate meal (vegetables, meat and trimmings)	400	Micro	900 W	4-6	sprinkle some water onto the sauce, cover, stir halfway through heating
Soup/stew	200	Micro	900 W	1-2	cover, stir after heating
Vegetables	200	Micro	900 W	2-3	if necessary add some water, cover
	500	Micro	900 W	3-5	stir halfway through heating
Meat, 1 slice*	200	Micro	900 W	approx. 3	thinly spread sauce over the top, cover
Fish fillet*	200	Micro	900 W	3-5	cover
Cake, 1 slice	150	Micro	450 W	½ -1	place in a flan dish
Baby food, 1 jar	190	Micro	450 W	½ -1	transfer into a suitable microwaveable container, after heating stir well and test the temperature
Melting margarine or butter*	50	Micro	900 W	½	cover
Melting chocolate	100	Micro	450 W	3-4	stir occasionally

* from chilled

Defrosting

Food	Quantity -g-	Setting	Power Level	Time -Min-	Method	Standing time -Min-
Goulash	500	Micro	270 W	8-9	stir halfway through defrosting	10-30
Cake, 1 slice	150	Micro	270 W	1-3	place in a flan dish	5
Fruit (e.g. cherries, strawberries, raspberries, plums)	250	Micro	270 W	3-5	spread out evenly, turn over halfway through defrosting	5

i The times shown in the table are guidelines which may vary according to freezing temperature, quality and weight of the foodstuffs.

Defrosting and cooking

Food	Quantity -g-	Setting	Power Level	Time -Min-	Added water	Method	Standing time -Min-
Fish fillet	300	Micro	900 W	9-11	-	cover	2
One plate meal	400	Micro	900 W	8-10	-	cover, stir after 6 minutes	2
Broccoli	300	Micro	900 W	6-8	3-5	cover, stir halfway through cooking	2
Peas	300	Micro	900 W	6-8	3-5	cover, stir halfway through cooking	2
Mixed vegetables	500	Micro	900 W	9-11	3-5	cover, stir halfway through cooking	2

Cooking, grilling and browning

Food	Quantity -g-	Setting	Power Level	Time -Min-	Method	Standing time -Min-
Broccoli	500	Micro	900 W	6-8	add 4-5 tbsps water, cover, stir halfway through cooking	-
Peas	500	Micro	900 W	6-8	add 4-5 tbsps water, cover, stir halfway through cooking	-
Carrots	500	Micro	900 W	9-11	cut into rings, add 4-5 tbsps water, cover, stir halfway through cooking	-
Roasts (pork, veal, lamb)	1000	Micro	450 W	16-18	season to taste, place on the low rack, turn over after*	10
		Dual Grill	450 W	5-7*		
		Micro	450 W	14-16		
		Dual Grill	450 W	4-6		
	1500	Micro	450 W	26-28		10
		Dual Grill	450 W	5-8*		
		Micro	450 W	26-28		
		Dual Grill	450 W	4-5		
Roast beef (medium)	1000	Micro	630 W	5-8	season to taste, place on the low rack, turn over after*	10
		Dual Grill	630 W	8-10*		
		Dual Grill	630 W	3-5		
	1500	Micro	630 W	12-15		10
		Dual Grill	630 W	12-15*		
		Dual Grill	630 W	4-6		
Chicken legs	200	Dual Grill Grill	450 W	6-7* 4-6	season to taste, place skin side down on the high rack, turn over after*	3
Rump steaks 2 pieces, medium	400	Grill Grill		11-12* 6-8	place on the high rack, turn over after*, season after grilling	
Browning of gratin dishes		Grill		8-13	place dish on the low rack	
Cheese toastie	1 piece	Micro Grill	450 W	½ 5-6	toast the bread and spread with butter, top with a slice of cooked ham, a slice of pineapple and a slice of cheese	
	4 pieces	Micro Grill	450 W	½ -1 5-6		
Frozen pizza	300	Micro	450 W	4-6	place on the low rack	
		Dual Grill	450 W	4-6		
	400	Micro	450 W	6-7		
		Dual Grill	450 W	5-7		

RECIPES

All the recipes in this book are calculated on the basis of 4 servings unless otherwise stated.

Adapting recipes for the microwave oven

If you would like to adapt your favourite recipes for the microwave, you should take note of the following: shorten cooking times by a third to a half. Follow the example of the recipes in this book.

Foods which have a high moisture content such as meat, fish, poultry, vegetables, fruit, stews and soups can be prepared in your microwave without any difficulty.

Foods which have little moisture, such as platters of food, should have the surface moistened prior to heating or cooking.

The amount of liquid to be added to raw foods, which are to be braised, should be reduced to about two thirds of the quantity in the original recipe. If necessary, add more liquid during cooking.

The amount of fat to be added can be reduced considerably. A small amount of butter, margarine or oil is sufficient to flavour food. For this reason your microwave is excellent for preparing low-fat foods as part of a diet.

Onion soup

Utensils: Bowl with lid (2 l capacity)
4 soup bowls (200 ml)

10 g butter or margarine
100 g onions, sliced
800 ml meat stock
salt and pepper
2 slices bread
40 g grated cheese

1. Grease the bowl, add the sliced onion, meat stock and the seasoning. Cover and cook. 9-11 min. 900 W
2. Toast the slices of bread, cut them into cubes and divide them among the soup bowls. Pour the soup over the toast cubes and sprinkle on the cheese.
3. Place the bowls on the turntable, and grill. 6-7 min. Grill

Aubergines stuffed with minced meat

Utensils: Bowl with lid (1 l capacity)
Shallow flan dish
(approx. 30 cm diameter)

250 g aubergines
200 g tomatoes
1 tbsop olive oil to grease the dish
100 g onions, chopped
4 mild green chillies, seeds removed
200 g minced beef
2 garlic cloves, crushed
2 tbsop parsley, chopped
salt and pepper
paprika
60 g Feta cheese, cubed

1. Cut the aubergines in half lengthways. Scoop out the flesh with a teaspoon to leave a shell about 1 cm thick. Dice the scooped-out flesh.
2. Remove the skin from the tomatoes and chop.
3. Grease the bottom of the bowl with the olive oil. Add the onions, cover and cook. 2 min. 900 W
4. Cut the chillies into rings. Retain a third for the garnish. Mix the minced meat with the diced aubergines, onions, tomatoes, chilli rings, garlic and parsley. Season to taste.
5. Dry the aubergine halves. Fill with half of the mince mixture, spread the feta cheese on top, and then add the rest of the filling.
6. Arrange the aubergine halves in the greased flan dish, place the dish on the low rack and cook. 11-13 min. Dual Grill (630 W)
Garnish the aubergine halves with the chilli rings and continue cooking. 4-7 min. Dual Grill (630 W)
After cooking, stand for approx. 2 min.

Mushrooms with rosemary

Utensils: Bowl with lid (1 l capacity)
Shallow round dish with lid
(approx. 22 cm diameter)

8	large mushrooms (approx. 225 g), whole
20 g	butter or margarine
50 g	onion, finely chopped
50 g	bacon, finely diced
	black pepper
	fresh rosemary, chopped
125 ml	dry white wine
125 ml	cream
20 g	flour

1. Remove the stalks from the mushrooms. Chop the stalks into small pieces.
2. Grease the shallow dish. Add the onions, the diced bacon and the mushroom stalks. Season with pepper and rosemary, cover and cook.
3-5 min. 900 W
Leave to cool.
3. Heat the cream and 100 ml of the wine in the bowl.
1-3 min. 900 W
4. Mix the remaining wine with the flour, stir into the hot liquid, cover and cook. Stir once during cooking.
approx. 1 min. 900 W
5. Fill the mushrooms with the bacon mixture and put in shallow dish. Pour the sauce over the mushrooms and cook on the rack.
6-8 min. Dual Grill (630 W)
After cooking, stand for approx. 2 min.

Sole fillets

Utensils: Shallow oval oven dish with microwave cling film (approx. 26 cm long)

400 g	sole fillets
1	lemon, whole
150 g	tomatoes
10 g	butter
1 tbsp	vegetable oil
1 tbsp	parsley, chopped
	salt and pepper
4 tbsp	white wine
20 g	butter or margarine

1. Wash the fish and pat dry. Remove any bones.
2. Cut the lemon and the tomatoes into thin slices.
3. Grease the oven dish with butter. Place the fish fillets in the dish and drizzle with the vegetable oil.
4. Sprinkle parsley over the dish, place the tomato slices on top and season. Place the lemon slices on top of the tomatoes and pour the white wine over them.
5. Place small pats of butter on top of the lemon, cover and cook.
11-13 min. 630 W
After cooking, stand for approx. 2 min.

Almond trout

Utensils: Shallow oval gratin dish (approx. 32 cm long)

4	trout (200 g), trimmed juice of one lemon salt
30 g	butter or margarine
50 g	flour
10 g	butter or margarine to grease the dish
50 g	almond flakes

1. Wash and dry the trout and sprinkle with lemon juice. Rub salt to the interior and exterior of the fish and leave to stand for 15 min.
2. Melt the butter.
1 min. 900 W
3. Dry the fish, spread with the butter and roll in the flour.
4. Grease the dish. Put the trout in the dish and cook on the low rack. Two thirds through the cooking turn the trout and scatter the almonds over them.
15-18 min. Dual Grill (450 W)
After cooking, stand for approx. 2 min.

Fish fillet with cheese sauce

Utensils: Bowl with lid (1 l capacity)
Shallow round gratin dish
(approx. 25 cm diameter)

800 g fish fillets
2 tbsp lemon juice
salt
10 g butter or margarine
50 g onion, finely chopped
20 g flour
100 ml white wine
1 tsp vegetable oil to grease the dish
100 g Emmental cheese, grated
2 tbsp parsley, chopped

1. Wash the fish, pat dry and sprinkle with lemon juice. Rub with salt.
2. Grease the bowl. Add the diced onion, cover and cook.
1-2 min. 900 W
3. Sprinkle the flour over the onions and white wine and mix.
4. Grease the gratin dish and place the fish in it. Pour the sauce over the fish and sprinkle with cheese. Place on the low rack and cook.
7-8 min. 450 W
14-16 min. Dual Grill (450 W)
After cooking, stand for approx. 2 min.

Zürich veal stew

Utensils: Bowl with lid (2 l capacity)

600 g veal fillet
10 g butter or margarine
50 g onion, finely chopped
100 ml white wine
seasoned gravy browning, for approx.
 $\frac{1}{2}$ l gravy
300 ml cream
1 tbsp parsley, chopped

1. Cut the veal into strips.
2. Grease the dish with the butter. Put the meat and onion into the dish, cover and cook. Stir once during cooking.
6-9 min. 900 W
3. Add the white wine, gravy browning and cream, stir, cover and continue cooking. Stir occasionally.
3-5 min. 900 W
4. Stir the mixture after cooking, stand for approx. 5 min. Garnish with parsley.

Stuffed ham

Utensils: Bowl with lid (2 l capacity)
Oval gratin dish with lid (approx. 26 cm long)

150 g leaf spinach, chopped
150 g fromage frais, 20 % fat content
50 g Emmental cheese grated
pepper and paprika
8 slices cooked ham (400 g)
125 ml water
125 ml cream
20 g flour
20 g butter or margarine
10 g butter or margarine to grease the dish

1. Mix the spinach with the cheese and fromage frais, season to taste.
2. Place a tablespoon of the filling on top of each slice of cooked ham, and roll up. Spear the ham with a wooden skewer to fasten it.
3. Make a béchamel sauce; to do this, pour the water and cream into a bowl and heat.
2-4 min. 900 W
Mix the flour and butter to make a roux, add to the liquid, and whisk until dissolved. Cover, cook until thick.
1-2 min. 900 W
Stir and taste.
4. Place the sauce into the greased dish, place the filled rolls of ham onto the sauce and cook with lid.
10-12 min. Dual Grill (630 W)
After cooking, stand for approx. 5 min.

Veal cutlets with mozzarella

Utensils: Shallow square gratin dish with lid (approx. 25 cm long)

150 g Mozzarella cheese, sliced
 500 g tinned tomatoes, drained
 4 veal cutlets (600 g)
 20 ml olive oil
 2 cloves of garlic, chopped
 20 g capers
 oregano
 salt and pepper

1. Wash the veal, dry and beat them flat.
2. Purée the tomatoes, add the garlic, oil, salt, pepper, capers and oregano and pour over the veal. Cover and cook.
15-19 min. 630 W
Turn the meat slices over.
3. Place slices of Mozzarella on each cutlet, season and cook uncovered on the high rack.
9-12 min. Dual Grill (630 W)
After cooking, stand for approx. 5 min.

Lasagne

Utensils: Bowl with lid (2 l capacity)
 Shallow square dish with lid (approx. 20 x 20 x 6 cm)

300 g tinned tomatoes
 50 g ham, chopped
 50 g onion, finely chopped
 1 clove of garlic, crushed
 250 g minced beef
 2 tbsp tomato purée
 salt and pepper
 150 ml crème fraîche
 100 ml milk
 50 g Parmesan cheese, grated
 1 tsp mixed chopped herbs
 1 tsp olive oil
 1 tsp vegetable oil to grease the dish
 125 g lasagne verde
 1 tbsp Parmesan cheese, grated

1. Chop the tomatoes, mix with the ham and onion, garlic, minced beef and tomato purée. Season, cover and cook.
5-8 min. 900 W
2. Mix the crème fraîche with the milk, Parmesan cheese, herbs, oil and spices.
3. Grease the dish and cover the bottom with about 1/3 of the pasta. Put half of the minced meat mixture on the pasta and pour on some sauce. Repeat and finish with the remaining pasta. Cover the pasta with sauce and sprinkle with Parmesan cheese. Cook with the lid on.
13-17 min. 630 W
After cooking, stand for approx. 5-10 min.

Courgette & noodle gratin

Utensils: Gratin dish (approx. 26 cm long)

80 g macaroni, cooked
 400 g tinned tomatoes, chopped
 150 g onion, finely chopped
 basil, thyme, salt and pepper
 1 tbsp oil to grease the dish
 450 g courgettes, sliced
 150 g sour cream
 2 eggs
 100 g Cheddar cheese, grated

1. Mix the tomatoes with the onions and season well. Add the macaroni. Pour the tomato sauce over the macaroni and spread the courgette slices on top.
2. Beat the sour cream and the eggs and pour over the gratin. Sprinkle the grated cheese on top. Place on the low rack and cook.
18-21 min. 900 W
7-8 min. Dual Grill (630 W)
After cooking, stand for approx. 5-10 min.

Pears in chocolate sauce

Utensils: Bowl with lid (2 l capacity)
 Bowl with lid (1 l capacity)
 4 whole pears, peeled (600 g)
 60 g sugar
 10 g vanilla sugar
 1 tbsp pear liqueur
 150 ml water
 130 g dark chocolate, chopped
 100 g crème fraîche

1. Place the sugar, vanilla sugar, pear liqueur and water into the bowl, stir, cover and cook. 1-2 min. 900 W
2. Place the pears in the liquid, cover and cook. 5-8 min. 900 W
 Take the pears out of the cooking liquid, and place in the refrigerator.
3. Put 50 ml of the cooking liquid into the smaller bowl. Add the chocolate and crème fraîche, cover and cook. 2-3 min. 900 W
4. Stir the sauce well, pour over the pears and serve.

Semolina pudding with raspberry sauce

Utensils: Bowl with lid (2 l capacity)
 4 Ramekin dishes
 500 ml milk
 40 g sugar
 15 g chopped almonds
 50 g semolina
 1 egg yolk
 1 tbsp water
 1 egg white
 250 g raspberries
 50 ml water
 40 g sugar

1. Place the milk, sugar and almonds in the bowl, cover and cook. 3-5 min. 900 W
2. Add the semolina, stir, cover and cook. 10-12 min. 270 W
3. Beat the egg yolk with the water in a cup and stir into the hot mixture. Beat the egg white until it is stiff, and fold it into the mixture. Pour the pudding into ramekins.
4. To make the sauce, wash and dry the raspberries and place into a bowl with the water and sugar. Cover and heat. 2-3 min. 900 W
5. Purée the raspberries and serve with the semolina pudding.

Cheesecake

Utensils: Spring form tin (approx. 26 cm diameter)
 Base:
 300 g flour
 1 tbsp cocoa
 10 g baking powder
 150 g sugar
 1 egg
 10 g butter or margarine to grease the tin
 Filling:
 150 g butter or margarine
 100 g sugar
 10 g vanilla sugar
 3 eggs
 400 g fromage frais, 20 % fat content
 40 g powdered vanilla pudding mix

1. In a bowl, mix together the flour, cocoa, baking powder and sugar.
2. Add the egg and butter and mix in a food processor.
3. Grease the tin. Roll out the dough and line the tin, leaving 2 cm around the edges to form a rim. Bake the pastry. 6-8 min. 630 W
4. Whisk the butter and sugar until light and fluffy. Slowly whisk in the eggs. Add the fromage frais and the powdered vanilla pudding mix.
5. Spread the mixture over the cheesecake base and cook. 15-19 min. 630 W

CARE AND CLEANING

CAUTION: DO NOT USE COMMERCIAL OVEN CLEANERS, STEAM CLEANERS, ABRASIVE, HARSH CLEANERS, ANY THAT CONTAIN SODIUM HYDROXIDE OR SCOURING PADS ON ANY PART OF YOUR MICROWAVE OVEN.

CLEAN THE OVEN AT REGULAR INTERVALS AND REMOVE ANY FOOD DEPOSITS. Failure to maintain the oven in a clean condition could lead to a deterioration of the surface that could adversely affect the life of the appliance and possibly result in a hazardous situation.

Oven exterior

The outside of your oven can be cleaned easily with mild soap and water. Make sure the soap is wiped off with a moist cloth, and dry the exterior with a soft towel.

Control panel

Open the door before cleaning to de-activate the control panel. Care should be taken when cleaning the control panel. Using a cloth dampened with water only, gently wipe the panel until it becomes clean.

Avoid using excessive amounts of water. Do not use any sort of chemical or abrasive cleaner.

Oven interior

1. For cleaning, wipe any splatters or spills with a soft damp cloth or sponge after each use while the oven is still warm. For heavier spills, use a mild soap and wipe several times with a damp cloth until all residues are removed. Do not remove the waveguide cover.
2. Make sure that mild soap or water does not penetrate the small vents in the walls which may cause damage to the oven.
3. Do not use spray type cleaners on the oven interior.
4. Heat up your oven regularly by using the grill. Remaining food or fat splashed can cause smoke or a bad smell.

Turntable and turntable support

Remove the turntable and turntable support from the oven. Wash the turntable and turntable support in mild soapy water. Dry with a soft cloth. Both the turntable and the turntable support are dishwasher safe.

Door

To remove all trace of dirt, regularly clean both sides of the door, the door seals and sealing surfaces with a soft, damp cloth. Do not use harsh abrasive cleaners or sharp metal scrapers to clean the oven door glass since they can scratch the surface, which may result in shattering of the glass.

Racks

These should be washed in a mild washing up liquid solution and dried. The racks are dishwasher safe.

 **Important!** A steam cleaner should not be used.

TROUBLESHOOTING

Problem	Check if . . .
The microwave appliance is not working properly?	<ul style="list-style-type: none"> • The fuses in the fuse box are working. • There has not been a power outage. • If the fuses continue to blow, please contact a qualified electrician.
The microwave mode is not working?	<ul style="list-style-type: none"> • The door is properly closed. • The door seals and their surfaces are clean. • The START/+30 button has been pressed.
The turntable is not turning?	<ul style="list-style-type: none"> • The turntable support is correctly connected to the drive. • The ovenware does not extend beyond the turntable. • Food does not extend beyond the edge of the turntable preventing it from rotating. • There is nothing in the well beneath the turntable.
The microwave will not switch off?	<ul style="list-style-type: none"> • Isolate the appliance from the fuse box. • Call your local Service Force Centre.
The interior light is not working?	<ul style="list-style-type: none"> • Call your local Service Force Centre. The interior light bulb can be exchanged only by trained Service Force technicians.
The food is taking longer to heat through and cook than before?	<ul style="list-style-type: none"> • Set a longer cooking time (double quantity = nearly double time) or • If the food is colder than usual, rotate or turn from time to time or • Set a higher power setting.

TECHNICAL INFORMATION

AC Line Voltage		230-240 V, 50 Hz, single phase
AC Power required:	Microwave	1.42 kW
	Grill	1.00 kW
	Microwave/Grill	2.4 kW
Output power:	Microwave	900 W (IEC 60705)
	Grill	1000 W
Microwave Frequency		2450 MHz * (Group 2/Class B)
Outside Dimensions:	EMS262040	594 mm (W) x 459 mm (H) x 404 mm (D)
Cavity Dimensions		342 mm (W) x 207 mm (H) x 368 mm (D) **
Oven Capacity		26 litres **
Turntable		ø 325 mm, glass
Weight		approx. 19.5 kg
Oven lamp		25 W/240-250 V

* This Product fulfils the requirement of the European standard EN55011. In conformity with this standard, this product is classified as group 2 class B equipment. Group 2 means that the equipment intentionally generates radio-frequency energy in the form of electromagnetic radiation for the heat treatment of food.

Class B equipment means that the equipment is suitable to be used in domestic establishments.

** Internal capacity is calculated by measuring maximum width, depth and height. Actual capacity for holding food is less.

This oven complies with the requirements of Directives 2004/108/EC, 2006/95/EC and 2005/32/EC.

SPECIFICATIONS ARE SUBJECT TO CHANGE WITHOUT NOTICE AS PART OF CONTINUOUS IMPROVEMENT



INSTALLATION

The microwave can be fitted in position A or B:

Position	Niche size		
	W	D	H
A	560	550	450
B	560	500	450

Measurements in (mm)

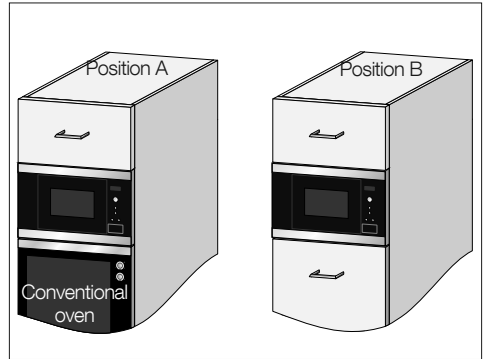

INSTALLING THE APPLIANCE

1. Remove all packaging and check carefully for any signs of damage.
2. Fit the appliance into the kitchen cupboard slowly, and without force, until the front frame of the oven seals against the front opening of the cupboard.
3. Ensure the appliance is stable and not leaning. Ensure that a 4 mm gap is kept between the cupboard door above and the top of the frame (see diagram).

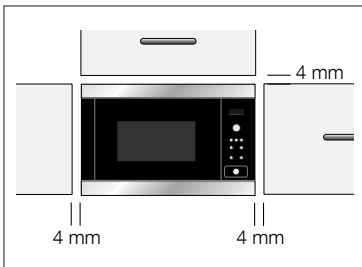

Fixing Option 1:

Fix the oven in position with the screws provided. The fixing points are located on the top and bottom corners of the oven.

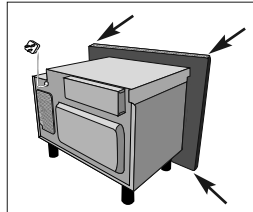

Fixing Option 2:

Please see the template sheet supplied with this oven.

⚠ Important!

Ensure the bottom of the oven is 85 cm or more above the floor. It is important to ensure that the installation of this product conforms to the instructions in this operation manual and the conventional oven manufacturer's installation instructions.

CONNECTING THE APPLIANCE TO THE POWER SUPPLY

- The electrical outlet should be readily accessible so that the unit can be unplugged easily in an emergency. Or it should be possible to isolate the oven from the supply by incorporating a switch in the fixed wiring in accordance with the wiring rules.
- The socket should not be positioned behind the cupboard.
- The best position is above the cupboard, see (A).

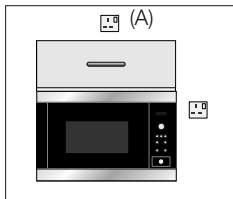

- Connect the appliance to a single phase 230-240 V/50 Hz alternating current via a correctly installed earth socket.
- **If the appliance is to be operated in a non-European country, the supply voltage, current type and frequency of the appliance indicated on the rating plate must correspond with the specification of your power supply. The rating plate can be found on the inside face of the control panel.**
- **The power supply cord may only be replaced by an electrician.**
- Before installing, tie a piece of string to the power supply cord to facilitate connection to point (A) when the appliance is being installed.
- When inserting the appliance into the high-sided cupboard, DO NOT crush the power supply cord.
- Do not immerse the power supply cord or plug in water or any other liquid.

ELECTRICAL CONNECTIONS



WARNING!

THIS APPLIANCE MUST BE EARTHED

The manufacturer declines any liability should this safety measure not be observed.

- If the plug that is fitted to your appliance is not suitable for your socket outlet, it must be cut off and the appropriate plug fitted.
- Remove the fuse from the cut off plug. The cut off plug should then be disposed of to prevent the hazard of shocks in case it should be plugged into the 13 A socket in another part of your home.



Important!

The wires in the mains lead are coloured in accordance with the following code:

GREEN AND YELLOW	EARTH
BLUE	NEUTRAL
BROWN	LIVE

If you fit your own plug, the colours of the wires in the mains lead of your appliance may not correspond with the markings identifying the terminals in your plug, proceed as follows:

- Connect the green and yellow (earth) wire to the terminal in the plug which is marked with the letter "E" or the earth symbol (\perp) or coloured green and yellow.
- Connect the blue (neutral) wire to the terminal in the plug which is marked with the letter "N" or coloured black.
- Connect the brown (live) wire to the terminal in the plug which is marked with the letter "L" or coloured red.

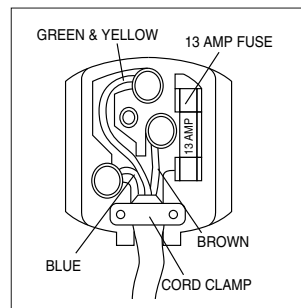

ENVIRONMENT CONCERNS

Ecologically responsible disposal of packaging materials and old appliances

PACKAGING MATERIALS

ELECTROLUX microwave ovens require effective packaging to protect them during transportation. Only the minimum packaging necessary is used. Packaging materials (e.g. foil or styrofoam) can place children at risk.

Danger of suffocation. Keep packaging material away from children.

All packaging materials used are environment friendly and can be recycled. The cardboard is made from recycled paper and the wooden parts are untreated. Plastic items are marked as follows:

«PE» polyethylene e.g. packaging film
 «PS» polystyrene e.g. packaging (CFC-free)
 «PP» polypropylene e.g. packaging straps

By using and re-using the packaging, raw materials are saved and waste volume is reduced. Packaging should be taken to your nearest recycling centre. Contact your local council for information.

DISPOSAL OF OLD APPLIANCES

Old appliances should be made safe before disposal by removing the plug, and cutting off and disposing of the power cable. It should then be taken to the nearest recycling centre. Check with your local Council or Environmental Health Office to see if there are facilities in your area for recycling the appliance.

The symbol  on the product or on its packaging indicates that this product may not be treated as household waste. Instead it should be taken to the appropriate collection point for the recycling of electrical and electronic equipment. By ensuring this product is disposed of correctly, you will help prevent potential negative consequences for the environment and human health, which could otherwise be caused by inappropriate waste handling of this product. For more detailed information about recycling of this product, please contact your local council, your household waste disposal service or the shop where you purchased the product.

GUARANTEE/CUSTOMER SERVICE

Standard guarantee conditions

We, Electrolux, undertake that if within 12 months of the date of the purchase this Electrolux appliance or any part thereof is proved to be defective by reason only of faulty workmanship or materials, we will, at our option repair or replace the same FREE OF CHARGE for labour, materials or carriage on condition that:

- Appliance has been correctly installed and used only on the electricity supply stated on the rating plate.
- Appliance has been used for normal domestic purposes only, in accordance with manufacturer's instructions.
- Appliance hasn't been serviced, maintained, repaired, taken apart or tampered with by person not authorised by us.
- Electrolux Service Force Centre must undertake all service work under this guarantee.

- Any appliance or defective part replaced shall become the Company's property.
- This guarantee is in addition to your statutory and other legal rights.

Exclusions

- Damage, calls resulting from transport, improper use, neglect, light bulbs, removable parts of glass, plastic.
- Costs for calls to put right appliance which is improperly installed, calls to appliances outside United Kingdom.
- Appliances found to be in use within a commercial environment, plus those which are subject to rental agreements.
- Products of Electrolux manufacturer that are not marketed by Electrolux.

Service and Spare Parts. Please contact your local Service Force Centre: **08445 616 616** (Call will be routed to Service Force Centre covering your postcode area). For address of local Service Force Centre and further information, please visit: **www.serviceforce.co.uk** Before calling out an engineer, please ensure you have read the details under the heading "Troubleshooting". When you contact the Service Force Centre you will need to give the following details:

Your name, address and postcode, your telephone number, clear concise details of the fault, model and serial number of the appliance (found on the rating plate), the purchase date. Please note a valid purchase receipt or guarantee documentation is required for in guarantee service calls.

Customer Care. Please contact our Customer Care Department: Electrolux Major Appliances, Addington Way, Luton, Bedfordshire, LU4 9QQ or visit our website at www.electrolux.co.uk

For Customer Service in The Republic of Ireland please contact us at the address below:

Electrolux Group (Irl) Ltd, Long Mile Road, Dublin 12, Republic of Ireland
Tel: +353 (0)1 4090751,
Email: service.eid@electrolux.ie

Customer Care Department	Tel: (Calls may be recorded for training purposes)
Electrolux	08445 613 613
AEG-Electrolux	08445 611 611
Zanussi-Electrolux	08445 612 612

European Guarantee:

This appliance is guaranteed by Electrolux in each of the countries listed at the back of this user manual, for the period specified in the appliance guarantee or otherwise by law. If you move from one of these countries to another of the countries listed, the appliance guarantee will move with you subject to the following qualifications:-

- The appliance guarantee starts from the date you first purchased the appliance which will be evidenced by production of a valid purchase document issued by the seller of the appliance.
- The appliance guarantee is for the same period and to the same extent for labour and parts as exists in your new country of residence for this particular model or range of appliances.

- The appliance guarantee is personal to the original purchaser of the appliance and cannot be transferred to another user.
- The appliance is installed and used in accordance with instructions issued by Electrolux and is only used within the home, i.e. is not used for commercial purposes.
- The appliance is installed in accordance with all relevant regulations in force within your new country of residence.

The provisions of this European Guarantee do not affect any of the rights granted to you by law.



www.aeg-electrolux.com/shop
www.electrolux.com/shop
www.zanussi.com/shop

Albania	+35 5 4 261 450	Rr. Pjeter Bogdani Nr. 7 Tirane
Belgique/België/ Belgien	+32 2 363 04 44	Bergensesteenweg 719, 1502 Lembeek
Česká republika	+420 261302111	Budějovická 3, Praha 4, 140 21
Danmark	+45 70 11 74 00	Sjællandsgade 2, 7000 Fredericia
Deutschland	+49 180 32 26 622	Fürther Str. 246, 90429 Nürnberg
Eesti	+37 2 66 50 030	Pärnu mnt. 153, 11624 Tallinn
España	+34 902 11 63 88	Carretera M-300, Km. 29,900 Alcalá de Henares Madrid
France	08 44 62 26 53	www.electrolux.fr
Great Britain	+44 8705 929 929	Addington Way, Luton, Bedfordshire LU4 9QQ
Hellas	+30 23 10 56 19 70	4, Limnou Str., 54627 Thessaloniki
Hrvatska	+385 1 63 23 338	Slavonska avenija 3, 10000 Zagreb
Ireland	+353 1 40 90 753	Long Mile Road Dublin 12
Italia	+39 (0) 434 558500	C.so Lino Zanussi, 26-33080 Porcia (PN)
Latvija	+371 67313626	Kr. Barona iela 130/2, LV-1012, Riga
Lietuva	+370 5 278 06 03	Ozo 10a, LT-08200 Vilnius
Luxembourg	+352 42 431 301	Rue de Bitbourg, 7, L-1273 Hamm
Magyarország	+36 1 252 1773	H-1142 Budapest XIV, Erzsébet királyné útja 87
Nederland	+31 17 24 68 300	Vennootsweg 1, 2404 CG - Alphen aan den Rijn
Norge	+47 81 5 30 222	Risløkkvn. 2, 0508 Oslo
Österreich	+43 18 66 400	Herziggasse 9, 1230 Wien
Polska	+48 22 43 47 300	ul. Kolejowa 5/7, Warszawa
Portugal	+35 12 14 40 39 39	Quinta da Fonte - Edifício Gonçalves Zarco - Q 35 -2774-518 Paço de Arcos
Romania	+40 21 451 20 30	Str. Garii Progresului 2, S4, 040671 RO
Schweiz/Suisse/ Svizzera	+41 62 88 99 111	Industriestrasse 10, CH-5506 Mägenwil
Slovenija	+38 61 24 25 731	Gerbičeva ulica 98, 1000 Ljubljana
Slovensko	+421 (02) 32141334	Electrolux Slovakia s.r.o., Electrolux Domáce spotrebiče SK, Seberíniho 1, 821 03 Bratislava
Suomi	www.electrolux.fi	
Sverige	+46 (0)771 76 76 76	Electrolux Service, S:t Göransgatan 143, S-105 45 Stockholm
Türkiye	+90 21 22 93 10 25	Tarlabaşı caddesi no : 35 Taksim İstambul
Россия	+7 495 937 7837	129090 Москва, Олимпийский проспект, 16, БЦ "Олимпик"
Україна	+380 44 586 20 60	04074 Київ, вул.Автозаводська, 2а, БЦ„Алкон”

