

ViewSonic®

VP730/VP730b LCD Display

- User Guide
- Guide de l'utilisateur
- Bedienungsanleitung
- Guía del usuario
- Guida dell'utente
- Guia do usuário
- Användarhandbok
- Käyttöopas
- Podręcznik użytkownika
- Használati útmutató
- Руководство пользователя
- Užívateľská príruka
- 使用手冊
- 使用手冊
- 사용자 안내서
- دليل المستخدم



ViewSonic®

Contents

TCO Information	i
Compliance Information.....	1
Important Safety Instructions.....	2
Copyright Information	3
Product Registration	3
Getting Started	
Package Contents	4
Precautions	4
Quick Installation	5
Landscape/Portrait Modes.....	6
To Raise and Lower the display.....	6
Wall Mounting (Optional)	7
Using the LCD Display	
Setting the Timing Mode.....	8
OSD and Power Lock Settings.....	8
Adjusting the Screen Image	9
Main Menu Controls	10
Other Information	
Specifications	15
Troubleshooting.....	16
Customer Support	17
Cleaning the LCD Display	18
Limited Warranty	19

TCO Information



Congratulations!

You have just purchased a TCO'99 approved and labelled product! Your choice has provided you with a product developed for professional use. Your purchase has also contributed to reducing the burden on the environment and also to the further development of environmentally adapted electronics products.

Why do we have environmentally labelled computers?

In many countries, environmental labelling has become an established method for encouraging the adaptation of goods and services to the environment. With the growing manufacture and usage of electronic equipment throughout the world, there is a recognized concern for the materials and substances used by electronic products with regards to their eventual recycling and disposal. By proper selection of these materials and substances, the impact on the environment can be minimized.

There are also other characteristics of a computer, such as energy consumption levels, that are important from the viewpoints of both the work (internal) and natural (external) environments. Electronic equipment in offices is often left running continuously, resulting in unnecessary consumption of large amounts of energy and additional power generation. From the standpoint of carbon dioxide emissions alone, it is vital to save energy.

What does labelling involve?

The product meets the requirements for the TCO'99 scheme which provides for international and environmental labelling of personal computers and/or displays. The labelling scheme was developed as a joint effort by the TCO (The Swedish Confederation of Professional Employees), Svenska Naturskyddsforeningen (The Swedish Society for Nature Conservation) and Statens Energimyndighet (The Swedish National Energy Administration).

Approval requirements cover a wide range of issues: ecology, ergonomics, emission of electrical and magnetical fields, energy consumption and electrical safety.

Ecological criteria impose restrictions on the presence and use of heavy metals, brominated and chlorinated flame retardants, and other substances. The product must be prepared for recycling and the manufacturing site(s) shall be certified according to ISO14001 or EMAS registered.

Energy requirements include a demand that the system unit and/or display, after a certain period of inactivity, shall reduce its power consumption to a lower level in one or more stages. The length of time to reactivate the system unit shall be reasonable for the user.

Labelled products must meet strict environmental demands, for example, in respect of the reduction of electrical and magnetical fields as well as work load and visual ergonomics.

Below you will find a brief summary of the ecological requirements met by this product. The complete ecological criteria document can be found at TCO Development's website <http://www.tcodevelopment.com> or may be ordered from:

TCO Development

SE-114 94 STOCKHOLM, Sweden

Fax: +46 8 782 92 07

E-mail: development@tco.se

Information regarding TCO'99 approved and labelled products may also be obtained at <http://www.tcodevelopment.com>

Ecological requirements

Flame retardants

Flame retardants may be present in printed wiring board laminates, cables, and housings. Their purpose is to prevent, or at least to delay the spread of fire. Up to 30% by weight of the plastic in a computer casing can consist of flame retardant substances. Many flame retardants contain bromine or chlorine, and these flame retardants are chemically related to PCBs (polychlorinated biphenyls). Both the flame retardants containing bromine or chlorine and the PCBs are suspected of giving rise to health effects, including reproductive damage in fish-eating birds and mammals, due to the bio-accumulative* processes when not disposed of in accordance with strict standards for disposal.

TCO'99 requires that plastic components weighing more than 25 grams shall not contain flame retardants with organically bound bromine or chlorine. Flame retardants are allowed in the printed wiring board laminates due to the lack of commercially available alternatives.

Cadmium**

Cadmium is present in rechargeable batteries and in the colour-generating layers of certain computer displays. TCO'99 requires that batteries, the colour-generating layers of display screens, and the electrical or electronics components shall not contain any cadmium.

Mercury**

Mercury is sometimes found in batteries, relays and switches. TCO'99 requires that batteries shall not contain any mercury. It also demands that mercury is not present in any of the electrical or electronics components associated with the labelled unit. There is however one exception. Mercury is, for the time being, permitted in the back light system of flat panel monitors as there today is no commercially available alternative. TCO aims on removing this exception when a mercury free alternative is available.

Lead**

Lead can be found in picture tubes, display screens, solders and capacitors. TCO'99 permits the use of lead due to the lack of commercially available alternatives, but in future requirements TCO Development aims at restricting the use of lead.

* Bio-accumulative is defined as substances which accumulate in living organisms.

**Lead, Cadmium and Mercury are heavy metals which are bio-accumulative.

- **This declaration is for TCO'99 compliance model.**

TCODevelopment



Congratulations!

The display you have just purchased carries the TCO'03 Displays label. This means that your display is designed, manufactured and tested according to some of the strictest quality and environmental requirements in the world. This makes for a high performance product, designed with the user in focus that also minimizes the impact on our natural environment.

Some of the features of the TCO'03 Display requirements:

Ergonomics

Good visual ergonomics and image quality in order to improve the working environment for the user and to reduce sight and strain problems. Important parameters are luminance, contrast, resolution, reflectance, colour rendition and image stability.

Energy

- Energy-saving mode after a certain time - beneficial both for the user and the environment
- Electrical safety

Emissions

- Electromagnetic fields
- Noise emissions

Ecology

- The product must be prepared for recycling and the manufacturer must have a certified environmental management system such as EMAS or ISO 14000
- Restrictions on
 - a. chlorinated and brominated flame retardants and polymers
 - b. heavy metals such as cadmium, mercury and lead.

The requirements included in this label have been developed by TCO Development in co-operation with scientists, experts, users as well as manufacturers all over the world. Since the end of the 1980s TCO has been involved in influencing the development of IT equipment in a more user-friendly direction. Our labelling system started with displays in 1992 and is now requested by users and IT-manufacturers all over the world.

For more information, please visit
www.tcodevelopment.com

- **This declaration is for TCO'03 compliance model.**

Compliance Information

For U.S.A.

This equipment has been tested and found to comply with the limits for a Class B digital device, pursuant to part 15 of the FCC Rules. These limits are designed to provide reasonable protection against harmful interference in a residential installation. This equipment generates, uses, and can radiate radio frequency energy, and if not installed and used in accordance with the instructions, may cause harmful interference to radio communications. However, there is no guarantee that interference will not occur in a particular installation. If this equipment does cause harmful interference to radio or television reception, which can be determined by turning the equipment off and on, the user is encouraged to try to correct the interference by one or more of the following measures:

- Reorient or relocate the receiving antenna.
- Increase the separation between the equipment and receiver.
- Connect the equipment into an outlet on a circuit different from that to which the receiver is connected.
- Consult the dealer or an experienced radio/TV technician for help.

FCC Warning

To assure continued FCC compliance, the user must use grounded power supply cord and the cables which are included with the equipment or specified. Also, any unauthorized changes or modifications not expressly approved by the party responsible for compliance could void the user's authority to operate this device.

For Canada

This Class B digital apparatus meets all requirements of the Canadian Interference-Causing Equipment Regulations.

Cet appareil numérique de la Classe B respecte toutes les exigences du Règlement sur le matériel brouilleur du Canada.

For European Countries

CE Conformity



The device complies with the requirements of the EEC directive 89/336/EEC as amended by 92/31/EEC and 93/68/EEC Art.5 with regard to “Electromagnetic compatibility,” and 73/23/EEC as amended by 93/68/EEC Art.13 with regard to “Safety.”

User Information for all Countries

Notice: Use the cables which are included with the unit or specified.

Important Safety Instructions

1. Read these instructions completely before using the equipment.
2. Keep these instructions in a safe place.
3. Heed all warnings.
4. Follow all instructions.
5. Do not use this equipment near water.
6. Clean with a soft, dry cloth. If further cleaning is required, see “Cleaning the Display” in this guide for further instructions.
7. Do not block any ventilation openings. Install the equipment in accordance with the manufacturer’s instructions.
8. Do not install near any heat sources such as radiators, heat registers, stoves, or other devices (including amplifiers) that produce heat.
9. Do not attempt to circumvent the safety provisions of the polarized or grounding-type plug. A polarized plug has two blades with one wider than the other. A grounding type plug has two blades and a third grounding prong. The wide blade and the third prong are provided for your safety. If the plug does not fit into your outlet, consult an electrician for replacement of the outlet.
10. Protect the power cord from being tread upon or pinched, particularly at the plug, and the point where it emerges from the equipment. Be sure that the power outlet is located near the equipment so that it is easily accessible.
11. Only use attachments/accessories specified by the manufacturer.
12. Use only with the cart, stand, tripod, bracket, or table specified by the manufacturer, or sold with the equipment. When a cart is used, use caution when moving the cart/equipment combination to avoid injury from tipping over.
13. Unplug this equipment when it will be unused for long periods of time.
14. Refer all servicing to qualified service personnel. Service is required when the unit has been damaged in any way, such as: if the power-supply cord or plug is damaged, if liquid is spilled onto or objects fall into the unit, if the unit is exposed to rain or moisture, or if the unit does not operate normally or has been dropped.

Copyright Information

Copyright © ViewSonic® Corporation, 2005. All rights reserved.

Macintosh and Power Macintosh are registered trademarks of Apple Computer, Inc.

Microsoft, Windows, Windows NT, and the Windows logo are registered trademarks of Microsoft Corporation in the United States and other countries.

ViewSonic, the three birds logo, OnView, ViewMatch, and ViewMeter are registered trademarks of ViewSonic Corporation.

VESA is a registered trademark of the Video Electronics Standards Association. DPMS and DDC are trademarks of VESA.

ENERGY STAR® is a registered trademark of the U.S. Environmental Protection Agency (EPA). As an ENERGY STAR® partner, ViewSonic Corporation has determined that this product meets the ENERGY STAR® guidelines for energy efficiency.

Disclaimer: ViewSonic Corporation shall not be liable for technical or editorial errors or omissions contained herein; nor for incidental or consequential damages resulting from furnishing this material, or the performance or use of this product.

In the interest of continuing product improvement, ViewSonic Corporation reserves the right to change product specifications without notice. Information in this document may change without notice.

No part of this document may be copied, reproduced, or transmitted by any means, for any purpose without prior written permission from ViewSonic Corporation.

Product Registration

To meet your future needs, and to receive any additional product information as it becomes available, please register your product on the Internet at: www.viewsonic.com. The ViewSonic Wizard CD-ROM also provides an opportunity for you to print the registration form, which you may mail or fax to ViewSonic.

For Your Records

Product Name:	VP730/b ViewSonic 17" LCD Display
Model Number:	VS10726
Document Number:	VP730/b-1_UG_ENG Rev. 1A 06-03-05
Serial Number:	_____
Purchase Date:	_____

Product disposal at end of product life

THE LAMP IN THIS PRODUCT CONTAINS MERCURY. Please dispose of in accordance with local, state or federal laws.

ViewSonic is concerned about the preservation of our environment. Please dispose of this product properly at the end of its useful life. For TCO'03 recycling information, please refer to our website:

1. USA: www.viewsonic.com/pdf/recyclePlus.pdf
2. Europe: www.viewsoniceurope.com
3. Taiwan: recycle.epa.gov.tw

Getting Started

Congratulations on your purchase of a ViewSonic® LCD display.

Important! Save the original box and all packing material for future shipping needs.

NOTE: The word “Windows” in this user guide refers to the following Microsoft operating systems: Windows ‘95, Windows NT, Windows ‘98, Windows 2000, Windows Me (Millennium), and Windows XP.

Package Contents

Your LCD display package includes:

- LCD display
- Power cord
- Video cable
- ViewSonic Wizard CD-ROM
- Perfect Suite™ software CD-ROM
- Quick Start Guide

NOTE: The CD includes the User Guide PDF files and INF/ICM display optimization files. The INF file ensures compatibility with Windows operating systems, and the ICM file (Image Color Matching) ensures accurate OSD colors. ViewSonic recommends that you install both the INF and ICM files.

Precautions

- Sit at least 18” from the LCD display.
 - **Avoid touching the screen.** Skin oils are difficult to remove.
 - **Never remove the rear cover.** This LCD display contains high-voltage parts. You may be seriously injured if you touch them.
 - Avoid exposing the LCD display to direct sunlight or another heat source. Orient the LCD display away from direct sunlight to reduce glare.
 - Always handle the LCD display with care when moving it.
 - Place the LCD display in a well ventilated area. Do not place anything on the LCD display that prevents heat dissipation.
 - Ensure the area around the LCD display is clean and free of moisture.
 - Do not place heavy objects on the LCD display, video cable, or power cord.
 - If smoke, an abnormal noise, or a strange odor is present, immediately switch the LCD display off and call your dealer or ViewSonic. It is dangerous to continue using the LCD display.
 - Do not rub or apply pressure to the LCD panel, as it may permanently damage the screen.
-

Quick Installation

1. Connect power cord (and AC/DC adapter if required)

2. Connect video cable

- Make sure both the LCD display and computer are turned OFF
- Remove rear panel covers if necessary
- Connect the video cable from the LCD display to the computer

Macintosh users: Models older than G3 require a Macintosh adapter. Attach the adapter to the computer and plug the video cable into the adapter.

To order a ViewSonic® Macintosh adapter, contact ViewSonic Customer Support.

3. Turn ON LCD display and computer

Turn ON the LCD display, then turn ON the computer. This sequence (LCD display before computer) is important.

NOTE: Windows users may receive a message asking them to install the INF file. This is on the CD.

4. Insert the ViewSonic Wizard CD into the computer's CD drive.

Follow the on-screen instructions. If your computer does not have a CD-ROM drive, see "Customer Support" on page 17.

- Wait for the CD-ROM to auto-start.

NOTE: If the CD-ROM does not auto-start: double-click on the CD-ROM icon in the Windows Explorer, then double-click on **viewsonic.exe**.

- Follow the on-screen instructions.

5. Windows users: Set the timing mode (resolution and refresh rate)

Example: 1280 x 1024 @ 60 Hz.

For instructions on changing the resolution and refresh rate, see the graphics card's user guide.

Installation is complete. Enjoy your new ViewSonic LCD display.

To be best prepared for any future customer service needs: print this user guide and write the serial number in "For Your Records" on page 3. (See back of LCD display.)

You can register your product online at the ViewSonic website for your region. See the Customer Support table in this guide.

The ViewSonic Wizard CD-ROM also provides an opportunity for you to print the registration form which you may mail or fax to ViewSonic.

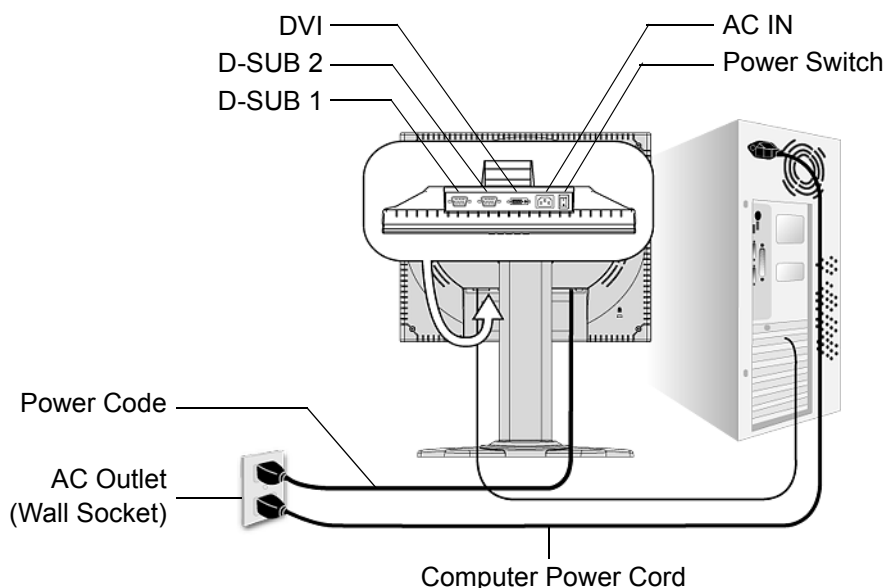

Landscape/Portrait Modes

The LCD display can operate in either Landscape or Portrait mode.

Follow the instructions that accompany the Perfect Suite™ software.

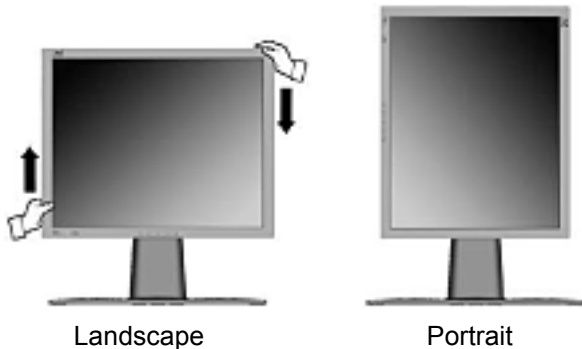

Note: Before using the portrait display mode, first install the Perfect Suite software included with your LCD display.

Perfect Suite software is compatible with most PCI and AGP graphics (video) cards.

For information about compatible graphics cards and approved hardware configurations, go to the ViewSonic website,

[http:// www.viewsonic.com](http://www.viewsonic.com)

To switch from Landscape (default) to Portrait mode, do the following:

1. From the front, gently raise the LCD display to allow more clearance.
2. Pull the bottom of the LCD display outward and away from the base.
3. Manually rotate the LCD display clockwise 90 degrees as shown above.

To Raise and Lower the display

You can easily raise and lower the display panel (the head) manually. As you face the front of the display, take hold of each side of the head and pull up or down. The panel should move easily.

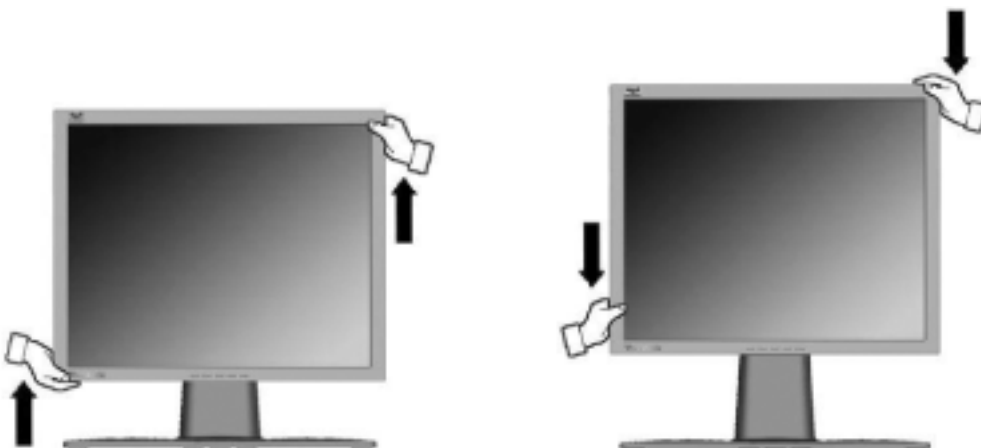

Wall Mounting (Optional)

To obtain a wall-mounting kit, contact ViewSonic® or your local dealer. Refer to the instructions that come with the base mounting kit. To convert your LCD display from a desk-mounted to a wall-mounted display, do the following:

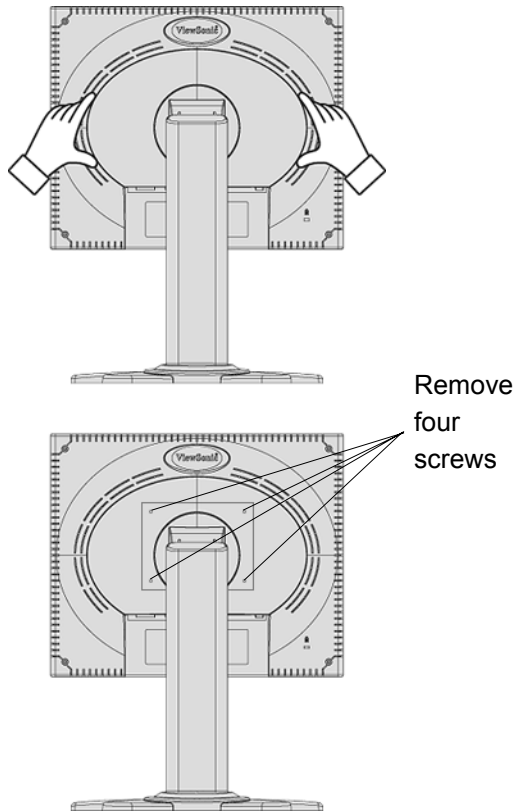

1. Verify that the Power button is turned Off, then disconnect the power cord.
2. Lay the LCD display face down on a towel or blanket.
3. Pull the back plate away from the head of the LCD display. Let the plate hang on the neck of the LCD display as shown on the left. Notice the four screws.
4. Remove the four screws from the back plate.
5. Attach the mounting bracket from the VESA compatible wall mounting kit (100 mm x 100 mm distance).
6. Attach the LCD display to the wall, following the instructions in the wall-mounting kit.

Using the LCD Display

Setting the Timing Mode

Setting the timing mode is important for maximizing the quality of the screen image and minimizing eye strain. The **timing mode** consists of the **resolution** (example 1280 x 1024) and **refresh rate** (or vertical frequency; example 60 Hz). After setting the timing mode, use the OSD (On-screen Display) controls to adjust the screen image.

For the best picture quality set your LCD display timing mode to:

VESA 1280 x 1024 @ 60Hz.

To set the Timing Mode:

- 1. Set the resolution:** Right-click on the Windows desktop > Properties > Settings > set the resolution.
- 2. Set the refresh rate:** See your graphic card's user guide for instructions.

WARNING: Do not set the graphics card in your computer to exceed the maximum refresh rate of 85Hz; doing so may result in permanent damage to your LCD display.

OSD and Power Lock Settings

- **OSD Lock:** Press and hold [1] and the up arrow ▲ for 10 seconds. If any buttons are pressed the message *OSD Locked* will display for 5 seconds.
- **OSD Unlock:** Press and hold [1] and the up arrow ▲ again for 10 seconds.
- **Power Button Lock:** Press and hold [1] and the down arrow ▼ for 10 seconds. If the power button is pressed the message *Power Button Locked* will display for 5 seconds. With or without this setting, after a power failure, your LCD display's power will automatically turn ON when power is restored.
- **Power Button Unlock:** Press and hold [1] and the down arrow ▼ again for 10 seconds.

Adjusting the Screen Image

Use the buttons on the front control panel to display and adjust the OSD controls which display on the screen. The OSD controls are explained at the top of the next page and are defined in “Main Menu Controls” on page 11.

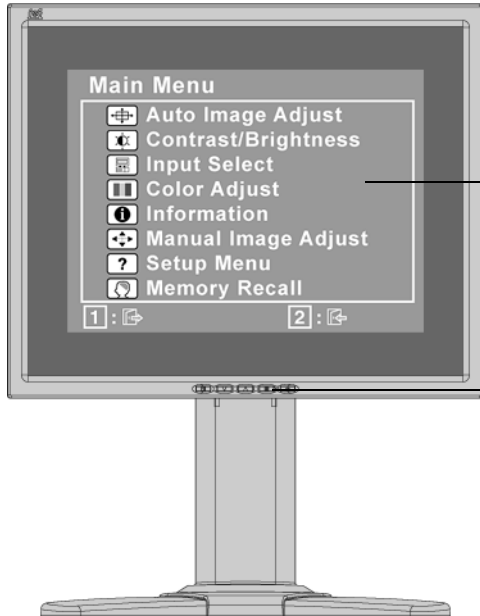

Main Menu
with OSD controls

Front Control Panel
shown below in detail

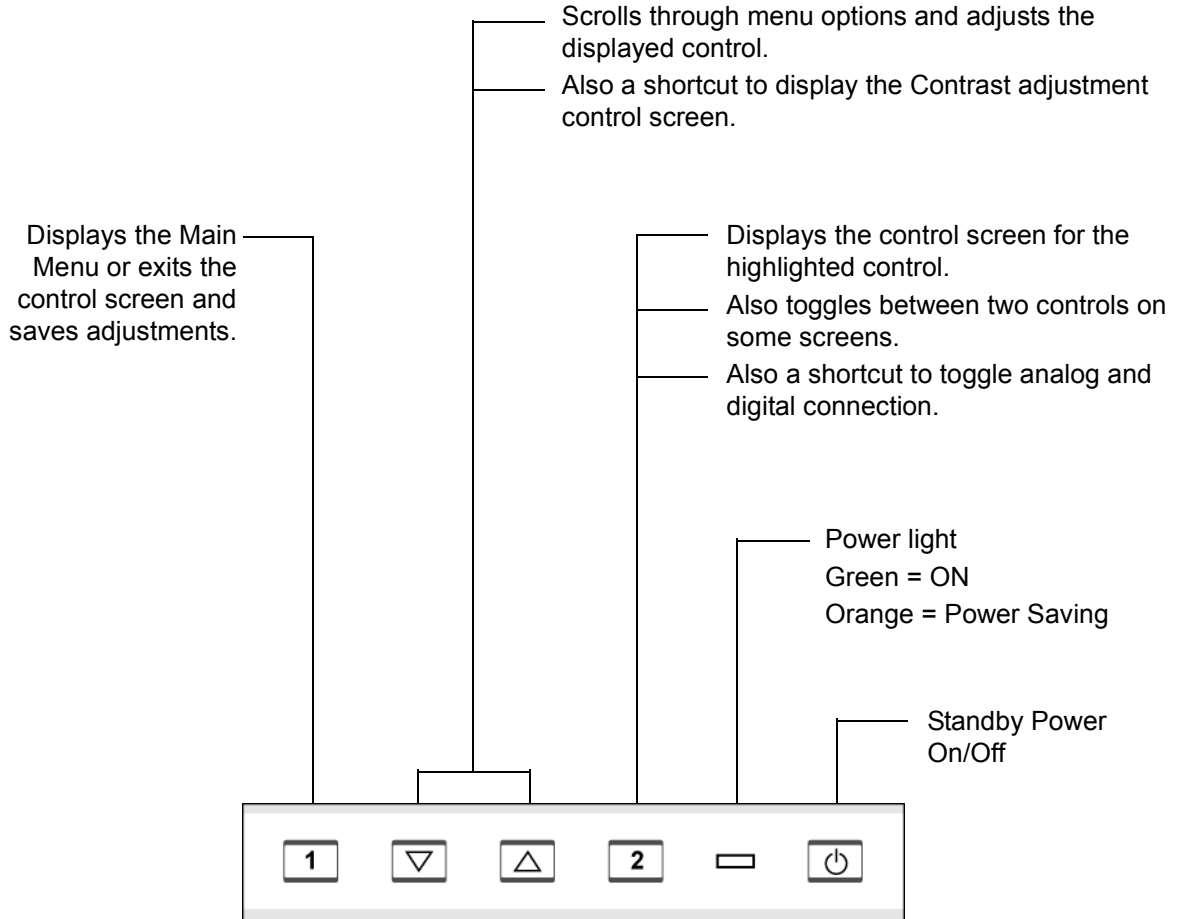

Do the following to adjust the display setting:

1. To display the Main Menu, press button [1].

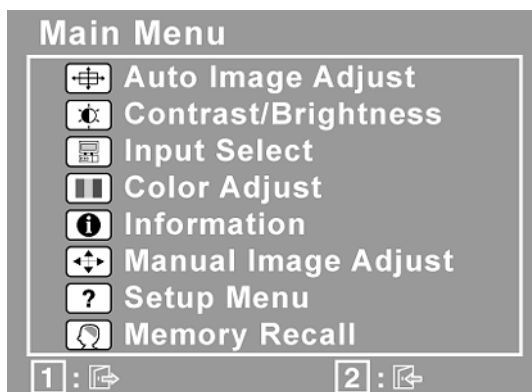

NOTE: All OSD menus and adjustment screens disappear automatically after about 15 seconds. This is adjustable through the OSD timeout setting in the setup menu.

2. To select a control to adjust, press▲or▼to scroll up or down in the Main Menu.
3. After the desired control is selected, press button [2]. A control screen like the one shown below appears.
4. To adjust the setting, press the up▲or down▼buttons.
5. To save the adjustments and exit the menu, press button [1] *twice*.

The following tips may help you optimize your display:

- Adjust the computer's graphics card so that it outputs a 1280 x 1024 @ 60Hz video signal to the LCD display. (Look for instructions on “changing the refresh rate” in the graphics card's user guide.)
- If necessary, make small adjustments using H. POSITION and V. POSITION until the screen image is completely visible. (The black border around the edge of the screen should barely touch the illuminated “active area” of the LCD display.)

Main Menu Controls

Adjust the menu items shown below by using the up▲and down▼buttons.

Control Explanation

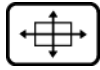

Auto Image Adjust automatically sizes, centers, and fine tunes the video signal to eliminate waviness and distortion. Press the [2] button to obtain a sharper image.

NOTE: Auto Image Adjust works with most common video cards. If this function does not work on your LCD display, then lower the video refresh rate to 60 Hz and set the resolution to its pre-set value.

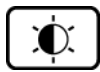

Contrast adjusts the difference between the image background (black level) and the foreground (white level).



Brightness adjusts background black level of the screen image.



Input Select allows the user to toggle between an analog and a digital signal.

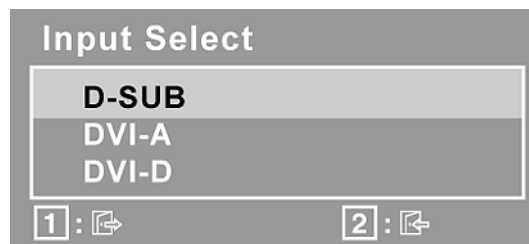

Color Adjust provides several color adjustment modes, including preset color temperatures and a User Color mode which allows independent adjustment of red (R), green (G), and blue (B). The factory setting for this product is 6500K (6500 Kelvin).

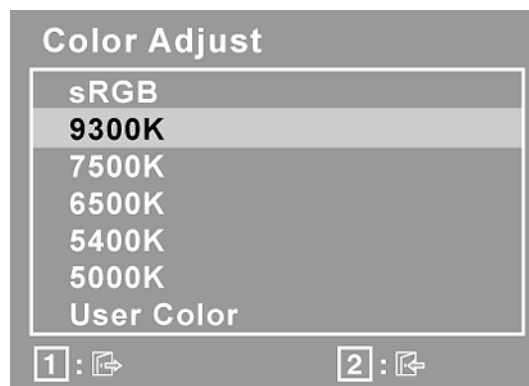

sRGB-This is quickly becoming the industry standard for color management, with support being included in many of the latest applications. Enabling this setting allows the LCD display to more accurately display colors the way they were originally intended. Enabling the sRGB setting will cause the Contrast and Brightness adjustments to be disabled.

Control Explanation

9300K - Adds blue to the screen image for cooler white (used in most office settings with fluorescent lighting).

7500K - Adds blue to the screen image for cooler white (used in most office settings with fluorescent lighting).

6500K - Adds red to the screen image for warmer white and richer red.

5400K - Adds green to the screen image for a darker color.

5000K - Adds blue and green to the screen image for a darker color.

User Color - Individual adjustments for red (R), green (G), and blue (B).

1. To select color (R, G or B) press button [2].

2. To adjust selected color, press▲ or▼.

Important: If you select RECALL from the Main Menu when the product is set to a Preset Timing Mode, colors return to the 6500K factory preset.



Information displays the timing mode (video signal input) coming from the graphics card in the computer, the LCD model number, the serial number, and the ViewSonic® website URL. See your graphics card's user guide for instructions on changing the resolution and refresh rate (vertical frequency).

NOTE: VESA 1280 x 1024 @ 60Hz (recommended) means that the resolution is 1280 x 1024 and the refresh rate is 60 Hertz.

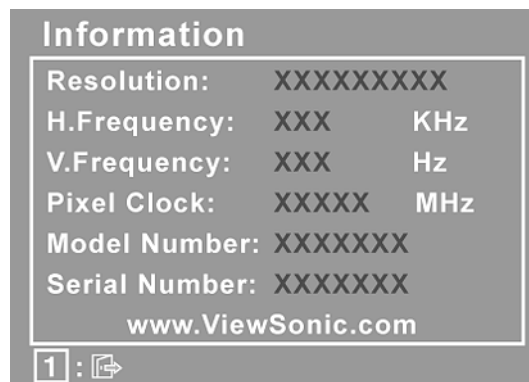

Manual Image Adjust displays the Manual Image Adjust menu.

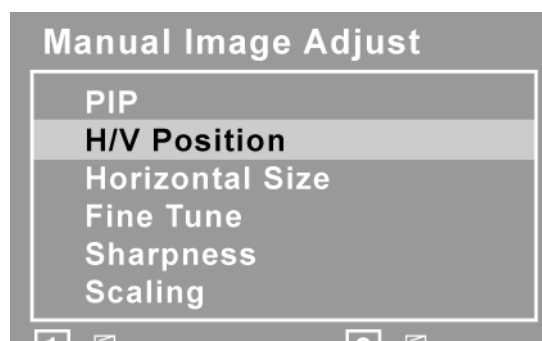

Control Explanation

H./V. Position (Horizontal/Vertical Position) moves the screen image left or right and up or down.

Horizontal Size adjusts the width of the screen image.

Fine Tune sharpens the focus by aligning text and/or graphics with pixel boundaries.

Sharpness adjusts the clarity and focus of the screen image.

Scaling adjusts the video input signal to the screen size other than 1280 x 1024 using the following options.

1:1 adjusts the video signal so that the height and width of the picture are the same.

Fill all adjusts the video signal to fill the screen.

Fill Aspect Ratio maintains the correct video signal proportions for different resolutions.



Setup Menu displays the menu shown below:

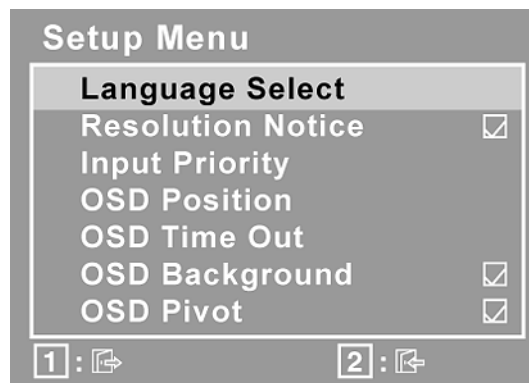

Language Select allows the user to choose the language used in the menus and control screens.

Resolution Notice allows the user to enable or disable this notice.

Input Priority If multiple computers will be connected to the display, this function can be used to select which computer has priority depending on the selected Input Priority, the display will do a one time detection for available inputs when first powered on.

OSD Position allows the user to move the OSD menus and control screens.

Control	Explanation
---------	-------------

OSD Timeout sets the length of time the OSD screen is displayed. For example, with a “15 second” setting, if a control is not pushed within 15 seconds, the display screen disappears.

OSD Background allows the user to turn the OSD background On or Off.

OSD Pivot This function is used to rotate the OSD menu, changing the OSD screen to Landscape or Portrait mode.



Memory Recall returns the adjustments back to factory settings if the display is operating in a factory Preset Timing Mode listed in the Specifications of this manual.

Exception: This control does not affect changes made with the User Color control, Language Select or Power Lock setting.

Other Information

Specifications

LCD	Type	17" (full 17" viewable diagonal area), TFT (Thin Film Transistor), Active Matrix SXGA LCD, 0.264 mm pixel pitch	
	Color Filter	RGB vertical stripe	
	Glass Surface	Anti-Glare	
Input Signal	Video	RGB analog (0.7/1.0 Vp-p, 75 ohms)	
	Sync	Composite Sync, Separate Sync, Sync on Green f _h :30-82 kHz, f _v :50-85 Hz	
	Digital	TMDS f _h :30-82 kHz, f _v :50-85 Hz	
Compatibility	PC	Up to 1280 x 1024 Non-interlaced	
	Macintosh ¹	Power Macintosh up to 1280 x 1024	
Resolution	Recommended and supported	1280 x 1024 @ 60, 75 Hz	
		1024 x 768 @ 60, 70, 72, 75 Hz	
		800 x 600 @ 56, 60, 72, 75 Hz	
		640 x 480 @ 60, 75 Hz	
		720 x 400 @ 70 Hz	
Power	Voltage	100-240 VAC, 50/60 Hz (auto switch)	
Display area	Full Scan	337.9 mm (H) x 270.3 mm (V) 13.3" (H) x 10.6" (V)	
Operating conditions	Temperature	32° F to + 104° F (0° C to + 40° C)	
	Humidity	10% to 90% (non-condensing)	
	Altitude	To 10,000 feet	
Storage conditions	Temperature	-4° F to + 140° F (-20° C to + 60° C)	
	Humidity	10% to 90% (non-condensing)	
	Altitude	To 40,000 feet	
Dimensions	Physical	372 mm (W) x 477 mm (H) x 279 mm (D) 14.6" (W) x 18.8" (H) x 11" (D)	
	LCD Display Only	308 mm (W) x 372 mm (H) x 56 mm (D) 12.1" (W) x 14.6" (H) x 2.2" (D)	
Weight	Net	12.6 lb (5.7 kg)	
	LCD Display Only	7.5 lb (3.4 kg)	
Regulations		BSMI, CCC, PSB, C-Tick, CE, GS, Ergo, Gost-R/Hygienic, SASO, TCO'99 (VP730b), TCO'03 (VP730) UL/cUL, FCC-B, ICES-B, NOM, TUV-S, ENERGY STAR [®]	
Power saving modes	On	Normal	(green LED)
	Off	<2W	(orange LED)

Preset Timing Mode (pre-adjusted to VESA[®] 1280 x 1024 @ 60 Hz)

Warning: Do not set the graphics card in your computer to exceed these refresh rates; doing so may result in permanent damage to the LCD display.

¹ Macintosh computers older than G3 require a ViewSonic[®] Macintosh adapter. To order an adapter, contact ViewSonic.

Troubleshooting

No power

- Make sure power button (or switch) is ON.
- Make sure A/C power cord is securely connected to the LCD display.
- Plug another electrical device (like a radio) into the power outlet to verify that the outlet is supplying proper voltage.

Power is ON but no screen image

- Make sure the video cable supplied with the LCD display is tightly secured to the video output port on the back of the computer. If the other end of the video cable is not attached permanently to the LCD display, tightly secure it to the LCD display.
- Adjust brightness and contrast.
- If you are using an Macintosh older than G3, you need a Macintosh adapter.

Wrong or abnormal colors

- If any colors (red, green, or blue) are missing, check the video cable to make sure it is securely connected. Loose or broken pins in the cable connector could cause an improper connection.
- Connect the LCD display to another computer.
- If you have an older graphics card, contact ViewSonic® for a non-DDC adapter.

Control buttons do not work

- Press only one button at a time.

Customer Support

For technical support or product service, see the table below or contact your reseller.

NOTE: You will need the product serial number.

Country/ Region	Website	T = Telephone F = FAX	Email
United States	www.viewsonic.com/support	T= (800) 688 6688 F= (909) 468 1202	service.us@viewsonic.com
Canada	www.viewsonic.com/support	T= (886) 463 4775 F= (909) 468 1202	service.ca@viewsonic.com
United Kingdom	www.viewsoniceurope.com/uk	T= 0207 949 0307 F= +44 (0) 1293 643 910	service.eu@viewsoniceurope.com
Europe, Middle East, Baltic countries, and North Africa	www.viewsoniceurope.com	(Contact your reseller)	service.eu@viewsoniceurope.com
Australia and New Zealand	www.viewsonic.com.au/support/	AUS= 1800 880 818 NZ= 0800 008 822	service@au.viewsonic.com
Singapore, Southeast Asia, and India	www.viewsonic.com.sg/support/	T= (65) 6273 4018 F= (65) 6273 1566	service@sg.viewsonic.com
South Africa and other countries	www.viewsonic.com	T= (65) 6273 4018 F= (65) 6273 1566	service@sd.viewsonic.com
Hong Kong	www.hk.viewsonic.com/support/	T= +852 2268 6878 F= +852 2268 6778	service@hk.viewsonic.com
Macau	www.hk.viewsonic.com/support/	T= +853 700 303	service@hk.viewsonic.com
Korean	www.viewsonic.com	T= 080 333 2131	service@kr.viewsonic.com

Cleaning the LCD Display

- MAKE SURE THE LCD DISPLAY IS TURNED OFF.
- NEVER SPRAY OR POUR ANY LIQUID DIRECTLY ONTO THE SCREEN OR CASE.

To clean the screen:

1. Wipe the screen with a clean, soft, lint-free cloth. This removes dust and other particles.
2. If the screen still not clean, apply a small amount of non-ammonia, non-alcohol based glass cleaner onto a clean, soft, lint-free cloth, and wipe the screen.

To clean the case:

1. Use a soft, dry cloth.
2. If the case still not clean, apply a small amount of a non-ammonia, non-alcohol based, mild non-abrasive detergent onto a clean, soft, lint-free cloth, then wipe the surface.

Disclaimer

- ViewSonic® does not recommend the use of any ammonia or alcohol-based cleaners on the LCD display screen or case. Some chemical cleaners have been reported to damage the screen and/or case of the LCD display.
- ViewSonic will not be liable for damage resulting from use of any ammonia or alcohol-based cleaners.

Limited Warranty

VIEWSONIC® LCD DISPLAY

What the warranty covers:

ViewSonic warrants its products to be free from defects in material and workmanship during the warranty period. If a product proves to be defective in material or workmanship during the warranty period, ViewSonic will, at its sole option, repair or replace the product with a like product. Replacement product or parts may include remanufactured or refurbished parts or components.

How long the warranty is effective:

ViewSonic LCD displays are warranted for three (3) years for all parts including the light source and three (3) years for all labor from the date of the first consumer purchase.

Who the warranty protects:

This warranty is valid only for the first consumer purchaser.

What the warranty does not cover:

1. Any product on which the serial number has been defaced, modified or removed.
2. Damage, deterioration or malfunction resulting from:
 - a. Accident, misuse, neglect, fire, water, lightning, or other acts of nature, unauthorized product modification, or failure to follow instructions supplied with the product.
 - b. Repair or attempted repair by anyone not authorized by ViewSonic.
 - c. Any damage of the product due to shipment.
 - d. Removal or installation of the product.
 - e. Causes external to the product, such as electrical power fluctuations or failure.
 - f. Use of supplies or parts not meeting ViewSonic's specifications.
 - g. Normal wear and tear.
 - h. Any other cause which does not relate to a product defect.
3. Any product exhibiting a condition commonly known as "image burn-in" which results when a static image is displayed on the product for an extended period of time.
4. Removal, installation, and set-up service charges.

How to get service:

1. For information about receiving service under warranty, contact ViewSonic Customer Support. You will need to provide your product's serial number.
2. To obtain service under warranty, you will be required to provide (a) the original dated sales slip, (b) your name, (c) your address, (d) a description of the problem, and (e) the serial number of the product.
3. Take or ship the product freight prepaid in the original container to an authorized ViewSonic service center or ViewSonic.
4. For additional information or the name of the nearest ViewSonic service center, contact ViewSonic.

Limitation of implied warranties:

There are no warranties, express or implied, which extend beyond the description contained herein including the implied warranty of merchantability and fitness for a particular purpose.

Exclusion of damages:

ViewSonic's liability is limited to the cost of repair or replacement of the product. ViewSonic shall not be liable for:

1. Damage to other property caused by any defects in the product, damages based upon inconvenience, loss of use of the product, loss of time, loss of profits, loss of business opportunity, loss of goodwill, interference with business relationships, or other commercial loss, even if advised of the possibility of such damages.
2. Any other damages, whether incidental, consequential or otherwise.
3. Any claim against the customer by any other party.

Effect of state law:

This warranty gives you specific legal rights, and you may also have other rights which vary from state to state. Some states do not allow limitations on implied warranties and/or do not allow the exclusion of incidental or consequential damages, so the above limitations and exclusions may not apply to you.

Sales outside the U.S.A. and Canada:

For warranty information and service on ViewSonic products sold outside of the U.S.A. and Canada, contact ViewSonic or your local ViewSonic dealer.

