

HUHAA Series

Modular Unit Heaters



FILE #E21609

Installation & Maintenance Instructions

Dear Owner,

Congratulations! Thank you for purchasing this new heater manufactured by a division of Marley Engineered Products. You have made a wise investment selecting the highest quality product in the heating industry. Please carefully read and follow the installation and maintenance directions shown in this manual. You should enjoy years of efficient heating comfort with this product from Marley Engineered Products... the industry's leader in design, manufacturing, quality and service.

*... The Employees of
Marley Engineered Products*



Read Carefully - These instructions are written to help you prevent difficulties that might arise during installation of heaters. Studying the instructions first may save you considerable time and money later. Observe the following procedures, and cut your mounting time to a minimum.

1. To prevent electrical shock, disconnect all power coming to heater at main service panel before wiring or servicing.
2. All wiring must be in accordance with the National and Local Electrical Codes and the heater must be grounded as a precaution against possible electric shock.
3. Verify the power supply voltage coming to heater matches the ratings printed on the heater nameplate before energizing.
4. This heater is hot when in use. To avoid burns, do not let bare skin touch hot surfaces.
5. Do not insert or allow foreign objects to enter any ventilation or exhaust opening as this may cause an electric shock, fire, or damage to the heater.
6. To prevent a possible fire, do not block air intakes or exhaust in any manner. Keep combustible materials, such as crates, drapes, etc., away from heater. Do not install behind door, furniture, towels, or boxes.
7. A heater has hot and arcing or sparking parts inside. Do not use it in areas where gasoline, paint or flammable liquids are stored.
8. Use this heater only as described in this manual. Any other use not recommended by the manufacturer may cause fire, electric shock, or injury to persons.
9. This heater is not approved for use in corrosive atmospheres such as marine, green house or chemical storage areas.

SAVE THESE INSTRUCTIONS

IMPORTANT

CAUTION

THE HEATER MUST BE MOUNTED AT LEAST 7' (2134mm) ABOVE THE FLOOR TO PREVENT ACCIDENTAL CONTACT WITH THE FAN BLADE WHICH COULD CAUSE INJURY.

CAUTION

ALL BUILT-IN THERMOSTATS: IF THE HEATER IS USED TO PREVENT PIPING OR LIQUIDS FROM FREEZING, AND IF THE THERMOSTAT IS SET BELOW 45° F (7°C), THE FAN MUST RUN CONTINUOUSLY.

CAUTION

THE CEILING MOUNTING STRUCTURE AND THE ANCHORING PROVISIONS MUST BE OF SUFFICIENT STRENGTH TO SUPPORT THE COMBINED WEIGHT OF THE HEATER AND MOUNTING BRACKET. (SEE TABLE 4).

CAUTION

TO PREVENT POSSIBLE OVERHEATING OR DAMAGE DUE TO OVERHEATING, KEEP AT LEAST 5' (1524mm) CLEARANCE IN FRONT OF HEATER. REFER TO TABLE 1 FOR SIDE, TOP, AND BACK CLEARANCE REQUIREMENTS.

DO NOT MOUNT MERCURY TYPE THERMOSTAT DIRECTLY ON UNIT. VIBRATION COULD CAUSE HEATER TO MALFUNCTION.

HEATER); ON ALL OTHER MODELS IT IS NEAR THE TOP REAR OF THE HEATER.

MANUAL RESET LIMIT (FACTORY INSTALLED OPTION ONLY.) THE LIMIT SWITCH IS LOCATED INTERNALLY ON THE REAR OF THE HEATER. ON THE 3KW AND 5KW MODELS, THE ACCESS TO THE RESET BUTTON IS ON THE RIGHT SIDE (WHEN FACING REAR OF

THE MANUAL RESET LIMIT IS IN SERIES WITH THE AUTOMATIC RECYCLING PROTECTOR (LIMIT). THE MANUAL RESET LIMIT WILL NOT RESET UNTIL THE HEATER HAS COOLED AND THE BUTTON IS PUSHED IN.

HEATER LOCATION INSTRUCTIONS

Arrange units so their discharge air streams:

- are subjected to a minimum of interference from columns, machinery and partitions;
- wipe exposed walls without blowing directly at them;
- are directed away from room occupants in comfort heating;
- are directed along the windward side when installed in a building exposed to a prevailing wind.

Locate thermostats approximately 5' (1524mm) above the floor on interior partition walls of posts, away from cold drafts, internal heat sources and away from heater discharge air streams.

Small rooms can be heated by one unit heater.

Large rooms require multi-unit installations. Number and capacity of units will be determined by volume of building and square feet of floor area to be heated. Arrange units to provide perimeter air circulation where each unit supports the air stream from another.

MOUNTING THE HEATER GENERAL

The heater may be mounted to discharge the heated air either horizontally or vertically. When the heater is mounted for vertical discharge, it is recommended that the heater be positioned so that the access door will open away from the wall to provide

greater access to the wiring and control compartment. If the heater is to be mounted with the access door facing a wall, the heater must be mounted far enough from that wall to allow full opening of the access door (a distance approximately equal to the width of the heater ... check clearance before installing). Refer to Table 1 for wall and ceiling clearances before mounting heater.

The heater may be mounted for either vertical or horizontal discharge by the use of threaded rods. (Refer to Table 2 for threaded rod sizes required.) Observe the detailed procedures in the following installation instructions.

The heater may also be suspended from the wall or ceiling by means of an optional mounting bracket (type HUHAAB or HCMB) which permits horizontal pivoting of the heater.

After the heater is installed, the louvers may be positioned to direct the heated air in the desired direction. When the heater is installed for horizontal discharge, the louvers should direct the air either straight ahead or downward. Directing the air upward may cause the heated air to remain in the ceiling area and waste energy.

HORIZONTAL DISCHARGE (Rod-mount from Ceiling)

1. Install four threaded mounting rods in the threaded holes and secure in place using lock nuts. (See Table 2).
2. Securely attach the four mounting rods to the ceiling. (Refer to Table 1 for wall and ceiling clearances, and Table 2 for mounting rod spacing).

VERTICAL DISCHARGE (Rod-Mount from Ceiling)

Table 1. Wall and Ceiling Clearance, inches (mm)

Unit	Discharge	Ceiling	Side Wall	Back Wall
3 & 5 kW	Horiz.	2 (50.8)	6 (152.4)	9 (228.6)
	Vert.	6 (152.4)	18 (457.2)	18 (457.2)
7.5 to 10 kW	Horiz.	6 (152.4)	6 (152.4)	13 (330.2)
	Vert.	6 (152.4)	24 (609.6)	24 (609.6)
15 to 10 kW	Horiz.	6 (152.4)	9 (228.6)	12½ (317.5)
	Vert.	6 (152.4)	24 (609.6)	24 (609.6)
25 to 50 kW	Horiz.	16 (406.4)	12 (304.8)	18½ (470.0)
	Vert.	12 (304.8)	36 (914.4)	36 (914.4)

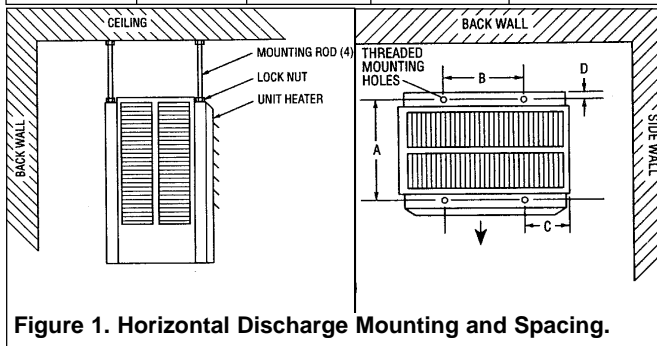

Figure 1. Horizontal Discharge Mounting and Spacing.

Table 2. Rod Thread and Spacing Dimensions, inches (mm) for Horizontal Discharge

Unit	Rod Thread Type	A	B	C	D
3 - 5 kW	5/16 - 18	6 1/16 (153.9)	6 (152.4)	4 1/16 (103.1)	3/4 (19.0)
7.5 - 10 kW			8 7/8 (225.6)	5 1/8 (130.3)	3/4 (19.0)
15 - 20 kW		11 3/8 (289.0)			
25 - 30 kW	3/8 - 16	10 9/16 (268.2)	14 1/2 (368.3)	6 3/16 (157.2)	5/8 (16.0)
40 - 50 kW		15 15/16 (404.9)	14 1/2 (368.3)	6 3/16 (157.2)	5/8 (16.0)

1. Remove bolts from the threaded holes in the back of the heater.
2. Install four threaded mounting rods in the threaded holes and secure in place using lock nuts.
3. Securely attach the four mounting rods to the ceiling. (Refer to Table 1 for wall and ceiling clearances, and Table 3 for mounting rod spacing dimensions.)

WIRING

BRANCH CIRCUIT (POWER)

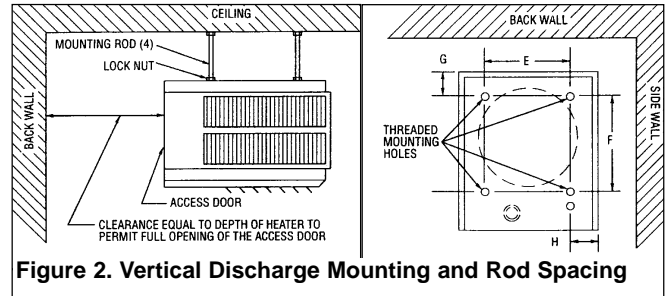

Figure 2. Vertical Discharge Mounting and Rod Spacing

Table 3. Rod Thread Type and Spacing Dimensions, inches (mm) for Vertical Discharge

Unit	Rod Thread Type	E	F	G	H
3 - 5 kW	5/16 - 18	6 (152.4)	9 3/4 (247.7)	2 (50.8)	4 1/16 (103.1)
7.5 - 20 kW		8 7/8 (225.6)	14 5/8 (371.6)	2 (50.8)	5 1/8 (130.3)
25 - 30 kW	3/8 - 16	14 1/2 (308.1)	21 1/4 (539.8)	2 3/16 (55.6)	6 3/16 (157.2)

1. Connect heater only to the voltage, amperage and frequency specified on the nameplate.
2. Field wiring must be properly sized to carry the amperage in accordance with the NEC.
3. The access door is hinged. There are either one or two screws accessible from the bottom, that must be removed to gain access.
4. A knockout is provided in the back of the heater close to the power terminal block and the control terminal board. The control terminal board knockout is 1/2 inch (12.7 mm) conduit size. The power terminal block knockout is multiple diameter. Use the diameter that fits the required conduit size.
5. A ground terminal is provided near the power terminal board. The ground wire should be connected before other connections are made.
6. The power terminal board is equipped with box terminals sized to accept the correct size power supply wire. Wire rated at 600 V and 60° C is satisfactory for the heater branch circuit. Either aluminum or copper wire is satisfactory for connection to the heater power terminal board box terminal. Copper wire is recommended and must be used with built-in disconnect switch.

7. Each heater has a wiring diagram affixed to the inside of the access door. Consult this diagram before making any field connections.
8. Single or three-phase power connections may be used with heater models HUHAA520, HUHAA524, HUHAA720, HUHAA724, HUHAA1020, HUHAA1024 and HUHAA1520. These units are factory wired for single phase operation. If these heaters are for use with three-phased power, reconnect the wires as indicated in the wiring diagram attached to the heater. Additional information can be found by looking at the wiring illustrations in Figures 3a and 3b and following the directions shown below.

On models HUHAA520, HUHAA524, HUHAA720, HUHAA724, HUHAA1020 and HUHAA1024 (Figure 3a), move only the two wires marked "A1" and marked "B1"; do not move or change any other wiring. The element lead wire marked "B1" which is factory connected to the power terminal block (terminal located closest to the elements) must be moved to terminal "B" on the three-phase terminal block.

The relay (contactor) lead wire "A1" must be moved from the end terminal of the power terminal block (terminal closest to the contactor or control terminal board) to the "A" terminal of the lower terminal block (center terminal).

Model HUHAA1520 (Figure 3b) has two three-phase terminal blocks located adjacent to the relays (contactors). Move only the two wires marked "C1" and "D1" on each of these two three-phase terminal blocks to terminal "B". Do not move or change any other wires.

9. Electrical Accessories, either kits or factory-installed options, are shown connected by a dashed line on the heater wiring diagram.
10. **208/240 VOLT HEATER.** Interchange transformer red and black primary leads (see wiring diagram) when the heater is to be connected to 208 volts supply.

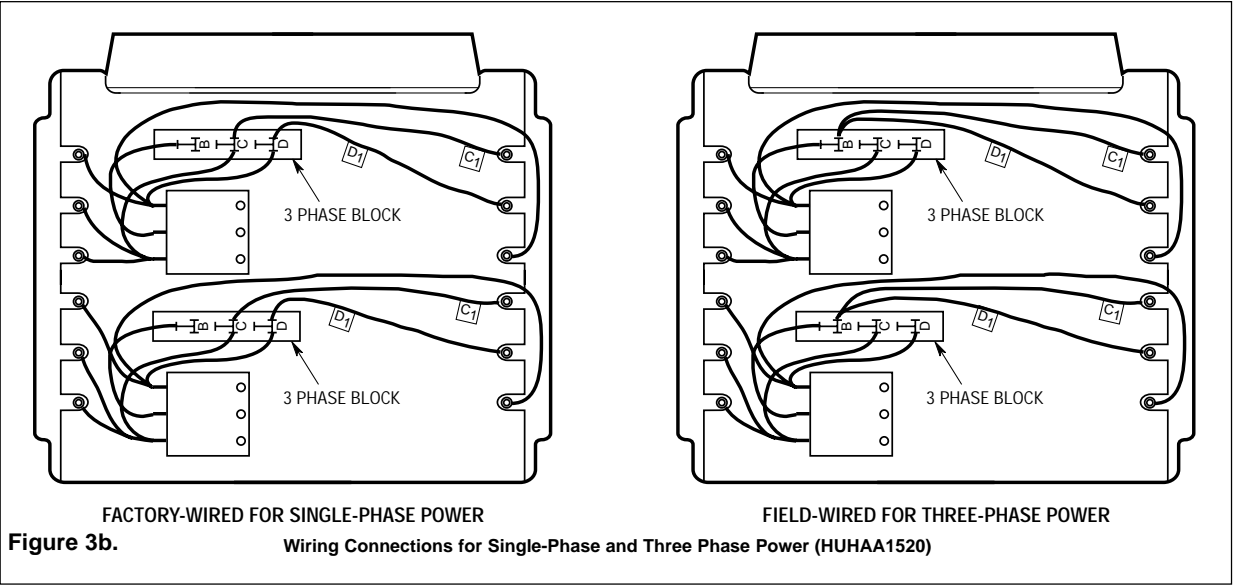
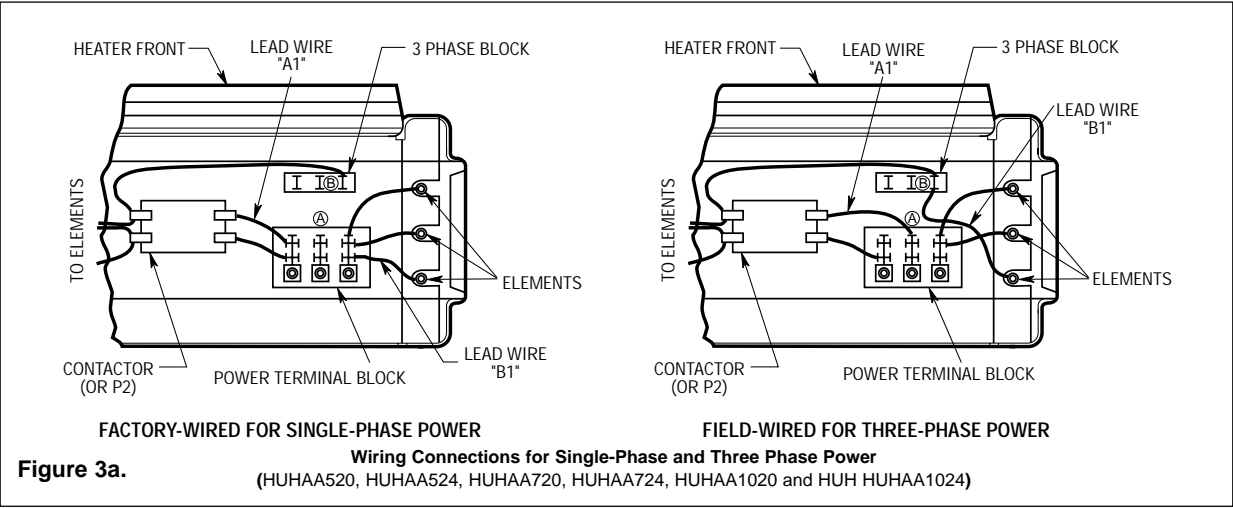

CONTROL WIRING

⚠ **WARNING** ⚡

LINE VOLTAGE IS PRESENT ON SOME OF THE TERMINALS ON THE CONTROL TERMINAL BOARD. ALWAYS DISCONNECT THE POWER FROM THE HEATER BEFORE MAKING ANY CONNECTIONS TO THE CONTROL BOARD TO PREVENT ELECTRIC SHOCK HAZARD.

1. Use min. 600 volts, NEC Class 1 insulated wire for all control circuit wiring.
2. Use a crimp-on type fork terminal on the wire ends that attach to the control terminal board if more than one connection is to be made under the terminal screw.
3. On units not provided with internal contactor (3 & 5 KW), refer to Figure 4 for wiring diagram.
Note: Thermostat and control circuit wiring must be suitable to handle the full load of the heater (example HUHAA520 is rated 24 amps)
4. On units provided with internal contactor (units rated 7 KW and higher) refer to Figure 5 for wiring diagram. Control wiring must be rated minimum 18 AWG.

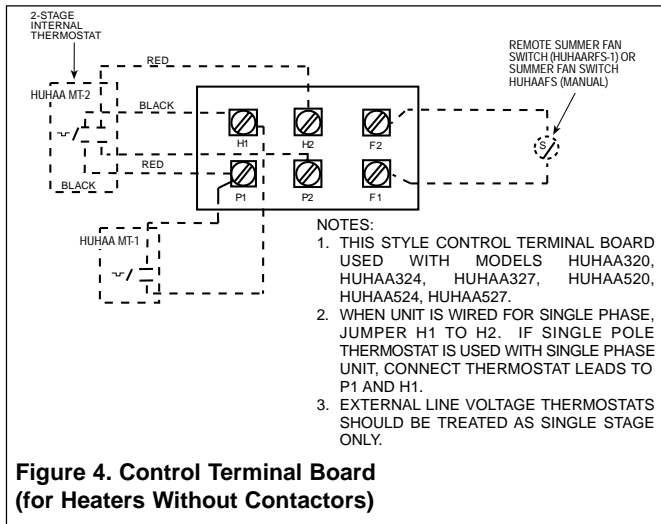
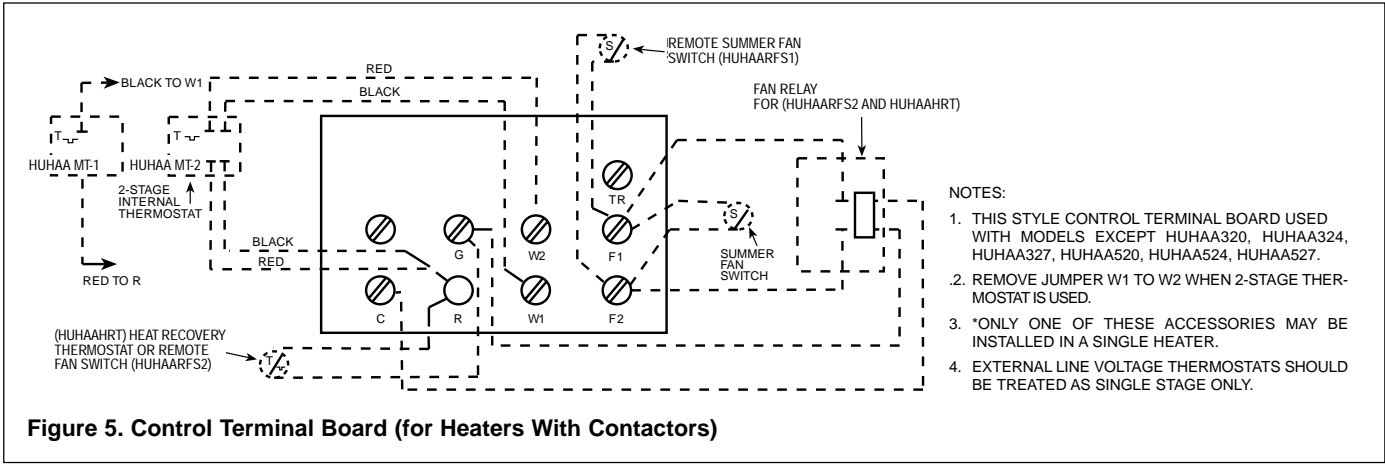
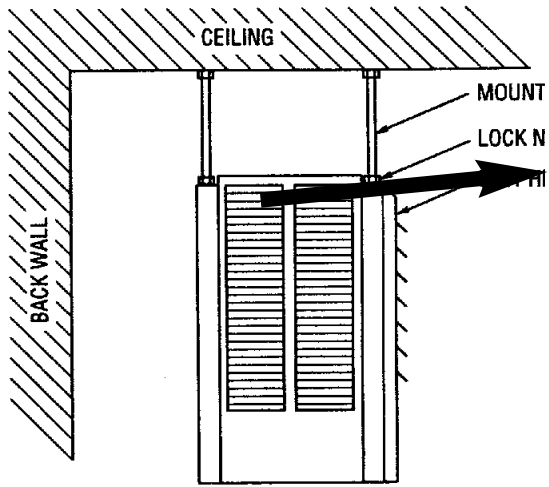

Table 4. Specifications

Basic Model No.	Height in (mm)	Width in. (mm)	Depth in. (mm)	Mounting Weight lbs. (kg)
HUHAA320				27 (12.2)
HUHAA324				27 (12.2)
HUHAA327				27 (12.2)
HUHAA348	16	14	8-1/2	27 (12.2)
HUHAA520	(406.4)	(355.6)	(214.4)	27 (12.2)
HUHAA524				27 (12.2)
HUHAA527				27 (12.2)
HUHAA548				30 (13.6)
HUHAA720				38 (17.2)
HUHAA724				38 (17.2)
HUHAA727				38 (17.2)
HUHAA748	21-3/4	19	8-1/2	38 (17.2)
HUHAA1020	(552.5)	(482.6)	(214.4)	38 (17.2)
HUHAA1024				38 (17.2)
HUHAA1027				38 (17.2)
HUHAA1048				38 (17.2)
HUHAA1520				53 (24.0)
HUHAA1524				53 (24.0)
HUHAA1548	21-3/4	19	13-3/4	53 (24.0)
HUHAA2020	(552.5)	(482.6)	(346.8)	60 (27.2)
HUHAA2024				60 (27.2)
HUHAA2048				60 (27.2)
HUHAA2524				93 (42.3)
HUHAA2548	30	26-5/8	13-3/4	93 (42.3)
HUHAA3020	(76.2)	(676.4)	(346.8)	93 (42.3)
HUHAA3024				93 (42.3)
HUHAA3048				93 (42.3)
HUHAA4024				119 (54.0)
HUHAA4048				119 (54.0)
HUHAA5020	30	26-5/8	18-1/8	119 (54.0)
HUHAA5024	(76.2)	(676.4)	(457.2)	119 (54.0)
HUHAA5048				119 (54.0)



IMPORTANT INFORMATION



NAMEPLATE

MODEL NO. HUHAA324		DATE CODE 0395		
MFG. NO.				
VOLTS AC	KILOWATTS	PHASE		
60 HZ				
208 / 240	2.2 / 3	1		
MOTOR		CONTROL		
VAC	AMP	VAC		
208/240	.25	208/240		
AIR FLOW				
	MINIMUM MOUNTING CLEARANCE			
	SIDE	BACK	CEILING	FLOOR
HORIZ.	6"	9.5"	2"	7'
VERT.	18"	18"	6"	7'
WARNING: DO NOT TURN LOUVERS ABOVE LEVEL OF THE UNIT. DISCONNECT POWER BEFORE SERVICING. IF EXTERNAL CONTROL IS USED, ALSO DISCONNECT EXTERNAL POWER SUPPLY.				
MARLEY ENGINEERED PRODUCTS BENNETTSVILLE, SC 29512			774G LISTED ROOM HEATER 4104-2088-001	

LIMITED WARRANTY

All products manufactured by Marley Engineered Products are warranted against defects in workmanship and materials for one year from date of installation, except heating elements which are warranted against defects in workmanship and materials for five years from date of installation. This warranty does not apply to damage from accident, misuse, or alteration; nor where the connected voltage is more than 5% above the nameplate voltage; nor to equipment improperly installed or wired or maintained in violation of the product's installation instructions. All claims for warranty work must be accompanied by proof of the date of installation.

The customer shall be responsible for all costs incurred in the removal or reinstallation of products, including labor costs, and shipping costs incurred to return products to Marley Engineered Products Service Center. Within the limitations of this warranty, inoperative units should be returned to the nearest Marley authorized service center or the Marley Engineered Products Service Center, and we will repair or replace, at our option, at no charge to you with return freight paid by Marley. It is agreed that such repair or replacement is the exclusive remedy available from Marley Engineered Products.

THE ABOVE WARRANTIES ARE IN LIEU OF ALL OTHER WARRANTIES EXPRESSED OR IMPLIED. AND ALL IMPLIED WARRANTIES OF MERCHANTABILITY AND FITNESS FOR A PARTICULAR PURPOSE WHICH EXCEED THE AFORESAID EXPRESSED WARRANTIES ARE HEREBY DISCLAIMED AND EXCLUDED FROM THIS AGREEMENT. MARLEY ENGINEERED PRODUCTS SHALL NOT BE LIABLE FOR CONSEQUENTIAL DAMAGES ARISING WITH RESPECT TO THE PRODUCT, WHETHER BASED UPON NEGLIGENCE, TORT, STRICT LIABILITY, OR CONTRACT.

Some states do not allow the exclusion or limitation of incidental or consequential damages, so the above exclusion or limitation may not apply to you. This warranty gives you specific legal rights, and you may also have other rights which vary from state to state.

For the address of your nearest authorized service center, contact Marley Engineered Products in Bennettsville, SC, at 1-800-642-4328. Merchandise returned to the factory must be accompanied by a return authorization and service identification tag, both available from Marley Engineered Products. When requesting return authorization, include all catalog numbers shown on the products.

HOW TO ORDER REPAIR PARTS

In order to obtain any needed repair or replacement parts, warranty service or technical information, please contact Marley Engineered Products Service Center toll-free by calling 1-800-642-HEAT.

When ordering repair parts, always give the information listed as follows:

1. The Part Number
2. The Model Number
3. The Part Description
4. Date of Manufacture



Marley
Engineered Products

SPX Corporation
470 Beauty Spot Rd. East
Bennettsville, SC 29512 USA

ECR 34640

Part No. 5200-2147-004

10/01