



**Owner's Manual for the Vehicle.  
With a quick reference guide  
for your convenience.**



**323Ci**

Congratulations, and thank you for choosing a BMW.

Thorough familiarity with your vehicle will provide you with enhanced control and security when you drive it. We therefore have this request:

Please take the time to read this Owner's Manual and familiarize yourself with the information that we have compiled for you before starting off in your new vehicle. It contains important data and instructions intended to assist you in gaining maximum use and satisfaction from the unique range of technical features on your BMW. The manual also contains information on care and maintenance designed to enhance operating safety and contribute to maintaining the value of your BMW throughout an extended service life.

This Owner's Manual should be considered a permanent part of this vehicle. It should stay with the vehicle when sold to provide the next owner with important operating, safety and maintenance information.

This manual is supplemented by a Service and Warranty Information Booklet (US models) or a Warranty and Service Guide Booklet (Canadian models). We recommend that you read this publication thoroughly.

Your BMW is covered by the following warranties:

- New Vehicle Limited Warranty
- Limited Warranty Rust Perforation
- Federal Emissions System Defect Warranty
- Federal Emissions Performance Warranty
- California Emission Control System Limited Warranty

Detailed information about these warranties is listed in the Service and Warranty Information Booklet (US models) or in the Warranty and Service Guide Booklet (Canadian models).

We wish you an enjoyable driving experience.

BMW AG

## Notes on the Owner's Manual

We have made every effort to ensure that you are able to find what you need in this Owner's Manual as quickly as possible. The fastest way to find certain topics is by using the detailed index at the end. If you wish to gain only an initial overview of your vehicle, you will find this in the first chapter.

The detailed list of contents that directly follows the summary of contents is intended to stimulate your curiosity regarding your BMW and to encourage you to read the manual.

Should you wish to sell your BMW at some time in the future, please remember to hand over the Owner's Manual to the new owner; it is part of the vehicle.

Should you have any further questions, your BMW center will be glad to assist at any time.

## Symbols used



These sections contain vital information – please read the accompanying text passages carefully, both for your own safety and to prevent damage to your BMW. ◀



indicates notes that alert you to specific features of your vehicle. ◀



Indicates special information on recycling. ◀

◀ Indicates the end of a note.

\* Indicates special equipment, country-specific equipment and optional extras.



Alerts you to functions that can be adjusted by your BMW center ("Car Memory" or "Key Memory"). Refer to page 60. ◀

## The individual vehicle

On purchasing your BMW, you have decided in favor of a model with individualized equipment and features. This Owner's Manual describes all models and equipment that BMW offers within the same range.

We hope you will understand that equipment and features are included which you might not have chosen for your vehicle. Any differences can easily be identified, since all optional accessories and special equipment are marked with an asterisk \*.

If your BMW features equipment which is not described in this Owner's Manual (car radio or telephone, for instance), Supplementary Owner's Manuals are enclosed. We ask you to read these manuals as well.

### **Status at time of printing**

BMW pursues a policy of continuous, ongoing development that is conceived to ensure that our vehicles continue to embody the highest quality and safety standards combined with advanced, state-of-the-art technology. For this reason, it is possible that the features described in this Owner's Manual could differ from those on your vehicle. Nor can errors and omissions be entirely ruled out. You are therefore asked to appreciate that no legal claims can be entertained on the basis of the data, illustrations or descriptions in this Owner's Manual.

## For your own safety

 Use unleaded gasoline only. Fuels containing up to and including 10% ethanol or other oxygenates with up to 2.8% oxygen by weight (i.e. 15% MTBE or 3% methanol plus an equivalent amount of co-solvent) will not void the applicable warranties respecting defects in materials or workmanship. Field experience has indicated significant differences in fuel quality (volatility, composition, additives, for example) among gasolines offered for sale in the United States and Canada. The use of poor-quality fuels may result in driveability, starting and stalling problems, especially under certain environmental conditions, such as high ambient temperature and high altitude. Should you encounter driveability problems which you suspect could be related to the fuel you are using, we recommend that you respond by switching to a recognized high-quality brand. Failure to comply with these recommendations may result in unscheduled maintenance. Follow the relevant safety rules when you are handling gasoline. ◀



### Important safety information.

For your own safety, use genuine parts and accessories approved by BMW.

When you purchase accessories tested and approved by BMW and Original BMW Parts, you simultaneously acquire the assurance that they have been thoroughly tested by BMW to ensure optimum performance when installed on your vehicle.

BMW warrants these parts to be free from defects in material and workmanship.

BMW will not accept any liability for damage resulting from installation of parts and accessories not approved by BMW.

BMW cannot test every product made by other manufacturers to verify if it can be used on a BMW safely and without risk to either the vehicle, its operation, or its occupants.

Original BMW Parts, BMW Accessories and other products approved by BMW, together with professional advice on using these items, are available from all BMW centers.

Installation and operation of non-BMW approved accessories such as alarms, radios, amplifiers, radar detectors, wheels, suspension components, brake dust shields, telephones (including operation of any portable cellular phone from within the vehicle without using an externally mounted antenna) or transceiver equipment (such as C.B., walkie-talkie, ham radio or similar devices) may cause extensive damage to the vehicle, compromise its safety, interfere with the vehicle's electrical system or affect the validity of the BMW Limited Warranty. See your authorized BMW center for additional information. ◀



Maintenance, replacement, or repair of the emission control devices and systems may be performed by any automotive repair establishment or individual using any certified automotive part. ◀

## Symbol for vehicle parts



Denotes vehicle parts for which you should consult this Owner's Manual.

The following applies only to vehicles owned and operated in the US.

## **REPORTING SAFETY DEFECTS**

If you believe that your vehicle has a defect that could cause a crash or could cause injury or death, you should immediately inform the National Highway Traffic Safety Administration (NHTSA) in addition to notifying BMW of North America, Inc., P.O. Box 1227, Westwood, New Jersey 07675-1227, Telephone (201) 307-4000.

If NHTSA receives similar complaints, it may open an investigation, and if it finds that a safety defect exists in a group of vehicles, it may order a recall and remedy campaign. However, NHTSA cannot become involved in individual problems between you, your dealer, or BMW of North America, Inc.

To contact NHTSA, you may either call the Auto Safety Hotline toll-free at 1-800-424-9393 (or 366-0123 in Washington, D.C. area) or write to: NHTSA, U.S. Department of Transportation, Washington, D.C. 20590. You can also obtain other information about motor vehicle safety from the Hotline.





Overview

Controls and features

Operation, care  
and maintenance

Owner service procedures

Advanced technology

Technical data

Index



# Contents

## Overview

- Cockpit 16
- Instrument cluster 18
- Indicator and warning lamps 20
- Multifunction steering wheel (MFL) 24
- Hazard warning flashers 25
- Warning triangle 25
- First-aid kit 25
- Refueling 26
- Fuel specifications 27
- Tire inflation pressure 27

## Controls and features

### Opening and closing:

- Keys 32
- Electronic vehicle immobilizer 33
- Central locking system 34
- Opening and closing – from outside 34
- Opening and closing – from inside 38
- Luggage compartment lid 39
- Luggage compartment 40
- Alarm system 42
- Electric power windows 44
- Manual convertible top 45
- The fully automatic convertible top 49
- Wind deflector 51

### Adjustments:

- Seats 53
- Seat and mirror memory 57
- Steering wheel 58
- Mirrors 58
- Car Memory, Key Memory 60

### Passenger safety systems:

- Safety belts 61
- ISOFIX Attachment of the child seat 62
- Airbags 63
- Child restraints 66
- Installing a child restraint system 67
- Rollover protection system 68

### Driving:

- Steering/Ignition lock 70
- Starting the engine 70
- Switch off the engine 71
- Parking brake 72
- Manual transmission 73
- Automatic transmission with Steptronic 74
- Turn signal indicator/ Headlamp flasher 77
- Washer/Wiper system/ Rain sensor 77
- Rear window defroster 79
- Cruise control 80

### Everything under control:

- Odometer 82
- Tachometer 82
- Energy Control 82
- Fuel gauge 83
- Coolant temperature gauge 83
- Service Interval Display 83
- Check Control 84
- Clock 84
- Onboard computer 85

### Technology for safety and driving convenience:

- Park Distance Control (PDC) 87
- Dynamic Stability Control (DSC) 88
- Tire Pressure Control (RDC) 89

- Controls and features**
- Lamps:**
    - Parking lamps/Low beams 91
    - Instrument lighting 91
    - High beams/Parking lamps 92
    - Fog lamps 92
    - Interior lamps 92
    - Reading lamps 93
  - Controlling the climate for pleasant driving:**
    - Automatic climate control 94
    - Seat heating 99
  - Cabin convenience:**
    - Glove compartment 99
    - BMW Universal Transmitter\* 100
    - Storage compartments 102
    - Cellular phone 103
    - Ashtray front 103
    - Cigarette lighter 104
    - Ashtray rear 104
  - Loading and transporting:**
    - Ski bag 105
    - Cargo loading 106
    - Luggage rack for the hardtop 108
- Operation, care and maintenance**
- Special operating instructions:**
    - Break-in procedures 112
    - Driving notes 113
    - Catalytic converter 113
    - Antilock Brake System (ABS) 114
    - Disc brakes 116
    - Brake system 117
    - Winter operation 118
    - Power steering 120
    - Cellular phone 120
    - Radio reception 120
    - Hardtop 121
  - Wheels and tires:**
    - Tire inflation pressure 123
    - Tire condition 123
    - Tire replacement 124
    - Tire rotation 125
    - Wheel and tire combinations 126
    - Winter tires 127
    - Snow chains 127
    - Approved wheel and tire specifications 128
  - Under the hood:**
    - Hood 129
    - Engine compartment 130
    - Washer fluids 132
    - Washer nozzles 132
    - Engine oil 133
    - Coolant 135
    - Brake fluid 136
    - Vehicle Identification Number 137
  - Care and maintenance:**
    - The BMW Maintenance System 138
    - Caring for your vehicle 139
    - Cleaning and caring for your convertible top 144
    - Airbags 146
    - Vehicle storage 147
  - Laws and regulations:**
    - Technical modifications to the vehicle 148
    - OBD interface socket 149

# Contents

## Owner service procedures

### Replacement procedures:

- Onboard tool kit [152](#)
- Windshield wiper blades [152](#)
- Lamps and bulbs [152](#)
- Changing a wheel [159](#)
- Battery [162](#)
- Fuses [165](#)

### In case of electrical malfunction:

- Fuel filler door [165](#)
- Fully automatic convertible top [166](#)

### Assistance, giving and receiving:

- Jump-starting [168](#)
- Towing the vehicle [169](#)

## Advanced technology

- Adaptive Transmission Control (ATC) [172](#)
- Airbags [173](#)
- Dynamic Stability Control (DSC) [173](#)
- Radio reception [174](#)
- Safety belt tensioner [174](#)
- Interior rearview mirror with automatic dimmer [175](#)
- Rain sensor [176](#)
- Tire Pressure Control (RDC) [177](#)
- Self-diagnostics [178](#)
- Rollover protection system [179](#)
- Xenon lamp [179](#)

## Technical data

- Engine data [182](#)
- Dimensions [183](#)
- Weights [184](#)
- Capacities [185](#)
- Electrical system [186](#)
- Drive belts [186](#)

**Index**

Everything from A to Z 190  
Owner service procedures 196



Cockpit 16  
 Instrument cluster 18  
 Indicator and warning lamps 20  
 Multifunction steering wheel  
 (MFL) 24  
 Hazard warning flashers 25  
 Warning triangle 25  
 First-aid kit 25  
 Refueling 26  
 Fuel specifications 27  
 Tire inflation pressure 27

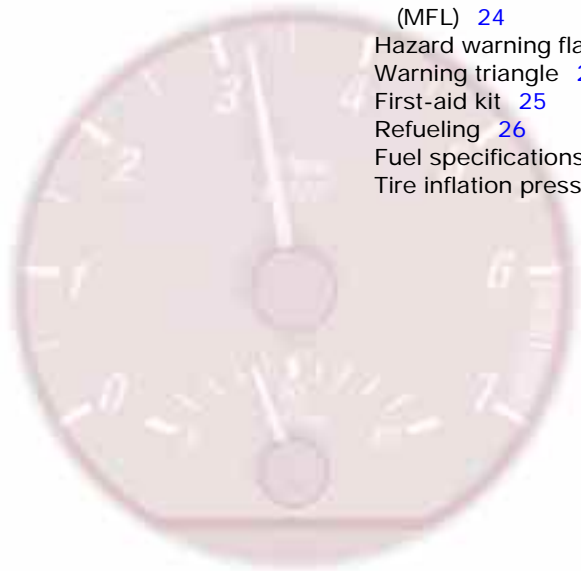

## Overview

### Controls and features

### Operation, care and maintenance

### Owner service procedures

### Advanced technology

### Technical data

## Index

## 16 Cockpit

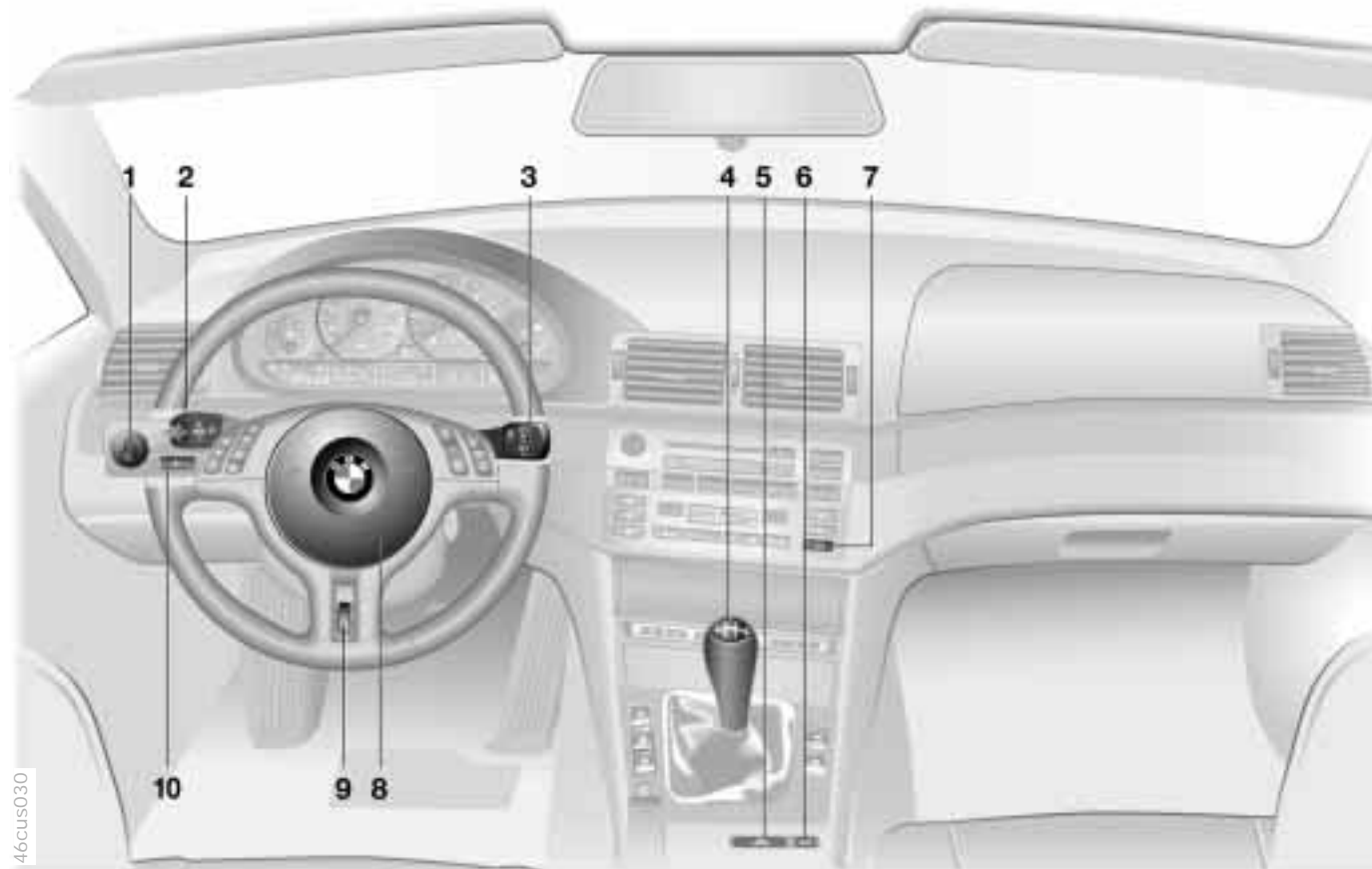



- 1 Parking lamps/Low beams [91](#)
- 2 ▷ Turn signals indicators [77](#)
  - ▷ Parking lamps [92](#)
  - ▷ High beams [92](#)
  - ▷ Headlamp flasher [77](#)
  - ▷ Onboard computer\* [85](#)
- 3 Washer/Wiper system [77](#)
- 4 Shift lever/Selector lever\* [73](#)

For vehicles equipped with manual transmission: to engage reverse gear, press the lever to the left and overcome the slight resistance you will encounter
- 5 Hazard warning flashers [25](#)
- 6 Central locking system [34](#)
- 7 Rear window defroster [79](#)
- 8 Horn: the entire surface
- 9 Adjusting steering wheel [58](#)
- 10 Fog lamps [92](#)

## 18 Instrument cluster



# Instrument cluster

- 1 Fuel gauge with indicator lamp for fuel reserve [83](#)
- 2 Turn signal indicator lamp [23](#)
- 3 Speedometer
- 4 Indicator lamp for
  - ▷ Battery charge current [20](#)
  - ▷ High beams [23](#)
  - ▷ Engine oil pressure/Engine oil level [20, 22](#)
- 5 Tachometer and Energy Control [82](#)
- 6 Engine coolant temperature gauge with "Coolant temperature too high" indicator [83](#)
- 7 Indicator and warning lamps (clockwise) for
  - ▷ Parking brake/Brake hydraulic system/Cornering Brake Control (CBC) [20](#)
  - ▷ Antilock Brake System (ABS) [22](#)
  - ▷ Brake pads [22](#)
  - ▷ Tire Pressure Control (RDC)\* [20, 22](#)
  - ▷ Rollover protection system [68](#)
  - ▷ Airbags [21](#)
  - ▷ Please fasten safety belts [21](#)
  - ▷ Cruise control [23](#)
- 8 Reset button for
  - ▷ Clock [84](#)
- 9 Program display for automatic transmission\* [76](#)  
Indicator lamp for automatic transmission\* [22, 76](#)
- 10 Indicator lamp for Dynamic Stability Control (DSC) [22](#)
- 11 Display for
  - ▷ Odometer [82](#)
  - ▷ Trip odometer [82](#)
  - ▷ Clock [84](#)
  - ▷ Service Interval [83](#)
 Display for onboard computer\*, operation via the turn signal lever, refer to page [85](#):
  - ▷ Clock
  - ▷ Outside temperature
  - ▷ Average fuel consumption
  - ▷ Cruising range
  - ▷ Average speed
- 12 Display for Check Control [84](#)
- 13 Trip odometer, reset to zero [82](#)

- 14 Indicator and warning lamps (clockwise) for
  - ▷ Fog lamps [23](#)
  - ▷ Add washer fluid [22](#)
  - ▷ Coolant level [23](#)
  - ▷ Electronic Engine Power Control (EML)\* [23](#)
  - ▷ Engine [22](#)

 You can display the outside temperature and distance driven in different units of measurement. ◀

## 20 Indicator and warning lamps

### Technology that monitors itself

Many of the systems of your BMW monitor themselves automatically, both during engine starts and while you are driving. Indicator and warning lamps that are identified by "●" are tested for proper functioning whenever the ignition key is turned. They each light up once for different periods of time.

If a fault should occur in one of these systems, the corresponding lamp does not go out after the engine is started, or it will light up while the vehicle is moving. You will see how to react to this below.

### Red: stop immediately



**Battery charge ●**

The battery is no longer being charged. There is a malfunction of the alternator V-belt or in the charging circuit of the alternator. Please contact the nearest BMW center.



If the ribbed V-belt is defective, do not continue driving. The engine could be damaged due to overheating. If the V-belt is defective, increased steering effort is also required. ◀



**Engine oil pressure ●**

Stop the vehicle immediately and switch off the engine. Check the engine oil level and refill as required. If the oil level is correct, please contact the nearest BMW center.



Do not continue driving. If you do so, the engine could be damaged because of inadequate lubrication. ◀



**Tire Pressure Control (RDC)\* ●**

In addition, an acoustic will go off: a tire failure has occurred. Reduce vehicle speed immediately to stop the vehicle. Avoid hard brake applications. Do not oversteer. For additional information, refer to page [89](#).



**Brake hydraulic system ●**

If the lamp comes on when the parking brake is not engaged, check the brake fluid level. Before driving further, be sure to read the notes on pages [117](#) and [136](#).



**Brake warning lamp for Canadian models.**

## Indicator and warning lamps

### Yellow: stop immediately



Engine oil level

Comes on while driving: Stop the vehicle immediately and switch off the engine. The oil level is at the absolute minimum.

For additional information, refer to page [133](#).



Do not continue driving until you have refilled the engine oil. If you continue to drive, the engine could be damaged because of inadequate lubrication. ◀

### Red and yellow: continue driving cautiously



Cornering Brake Control

(CBC) ●



If the brake warning lamp comes on together with the yellow indicator lamps for ABS and DSC:



The entire ABS, CBC and DSC control system has failed. Continue driving cautiously and defensively. Avoid hard brake applications. Please have the system checked by your BMW center as soon as possible.

For additional information, refer to pages [88](#), [115](#).



CBC, ABS and DSC indicator and warning lamps for Canadian models.



### Red: an important reminder



Parking brake

Comes on when the parking brake is applied – an additional acoustic signal sounds when starting off.

For additional information, refer to page [72](#).



Brake warning lamp for Canadian models.



Please fasten safety belts ● An acoustic warning signal sounds at the same time. Lights up for a few seconds or until the safety belt is fastened.

For additional information on safety belts, refer to page [61](#).



Airbags ●

Please have the system inspected by your authorized BMW center.

For additional information, refer to pages [63](#), [173](#).

## 22 Indicator and warning lamps

### Orange: consult the nearest BMW center



Automatic transmission\*  
Because of a malfunction, the automatic transmission shifts only in the emergency program. Please consult the nearest BMW center. For additional information, refer to page [76](#).

### Yellow: check as soon as possible



Antilock Brake System (ABS) ●  
ABS has been deactivated in response to system malfunction. Conventional braking efficiency is available without limitations. Please have the system inspected by your BMW center. For additional information, refer to page [115](#).



ABS warning lamp for Canadian models.



Engine oil level  
Comes on after the engine has been switched off: check the engine oil level. For additional information, refer to page [133](#).



Brake pads ●  
Have the brake pads checked. For additional information, refer to page [117](#).



Tire Pressure Control (RDC)\* ●  
Check the tire pressure. For additional information, refer to pages [27](#) and [89](#).



Dynamic Stability Control (DSC) ●  
DSC has been deactivated in response to system malfunction or by means of the button. In the event of a malfunction, have the system checked by your BMW center. For additional information, refer to page [88](#).



Add washer fluid  
The washer fluid is too low. Top off the fluid at the earliest opportunity. For additional information, refer to page [132](#).



Service Engine Soon ●  
If the indicator lamp comes on either continuously or intermittently, this indicates a fault in the emissions-related electronic systems. Although the vehicle remains operational, you should have the systems checked by your BMW center at the earliest possible opportunity. For additional information, refer to page [149](#).



"Service Engine Soon" warning lamp for Canadian models.

# Indicator and warning lamps



**Engine Power Control (EML)\* ●**  
Malfunction in the EML. Please have the system inspected by your BMW center.



**Add coolant**  
The coolant level is too low. Top off the coolant at the earliest opportunity.

For additional information, refer to page [135](#).

## Green: for your information



**Turn signal indicators**  
Flashes when the turn signal indicators are operated. Rapid flashing indicates a system malfunction. For additional information, refer to page [77](#).



**Cruise control**  
Lights up when the cruise control is activated. Available for operation via the multifunction steering wheel. For additional information, refer to page [80](#).



**Fog lamps**  
Lights up whenever you switch on the fog lamps. For additional information, refer to page [92](#).

## Blue: for your information



**High beams**  
Lights up when the high beams are on or the headlamp flasher is actuated. For additional information, refer to pages [77](#), [92](#).

## 24 Multifunction steering wheel (MFL)

The buttons integrated in the multifunction steering wheel are provided so that you can operate a number of accessories quickly and without being distracted from traffic conditions. You can operate:

- ▷ selected radio functions
- ▷ the cruise control
- ▷ selected cellular phone functions.



In order to operate a system via the MFL, the corresponding systems must be switched on. ◀

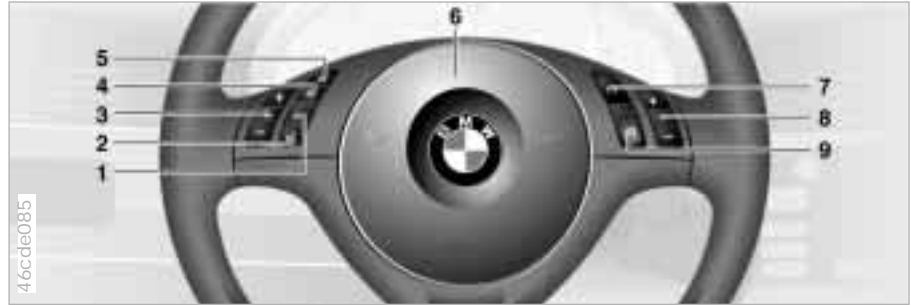

- |   |  |
|---|--|
| 1 Radio/Cellular phone: select  | 6 Horn: the entire surface   |
| 2 Cellular phone: receive a call, start dialing, terminate a call                             | 7 Cruise control: activate stored setting (resume)                   |
| 3 Radio/Cellular phone: volume  | 8 Cruise control: store and accelerate (+); decelerate and store (-) |
| 4 Radio/Cellular phone: scan backward or station buttons or scroll through the phone listings | 9 Cruise control: activate/interrupt/cancel.                         |
| 5 Radio/Cellular phone: scan forward or station buttons or scroll through the phone listings  |  |



## Hazard warning flashers



The button flashes intermittently when the hazard flashers are on.

To help you locate the button in an emergency, the button is also illuminated whenever the vehicle's lamps are on.

 The turn signal indicator function takes priority over the hazard warning flasher function. This means that with the ignition key in position 1, you can still use the turn signal indicator function, even if the hazard warning flashers are being used at the same time. ◀

## Warning triangle\*



For easy access, the hazard warning triangle is stored in the onboard tool kit in the luggage compartment lid.

To open it, loosen the wing nut screw.

 Comply with legal requirements for keeping a hazard warning triangle in the vehicle. ◀

## First-aid kit\*



The first-aid kit is located under the passenger seat.

To open: press the button (arrow) and fold the lid downward.

To close: fold the lid up until it audibly engages.

 Some of the articles in the first-aid kit may be used within a limited time only. For this reason, check the expiration dates of each of the items regularly, and replace any with passed dates. You can purchase replacements in any drugstore or pharmacy. Comply with legal requirements for keeping a first-aid kit in the vehicle. ◀

## 26 Refueling



### Fuel filler door

 Before filling the tank, shut off the engine. If you do not, fuel cannot flow into the tank and the "Service Engine Soon" lamp may come on. ◀

Press on the rear edge of the fuel filler door to open and close it.

To unlock the filler door if the central locking system malfunctions, refer to page [165](#).

 When handling fuels, comply with all of the applicable safety precautions and regulations pertaining to fuels. Never carry spare fuel containers in your vehicle. Whether empty or full, these containers can leak, cause an explosion, or lead to fire in the event of a collision. ◀



### Simple and environmentally friendly

 Open the filler cap carefully to prevent fuel from spraying out. Fuel spray may cause injury. ◀

Place (or put) the filler cap in the bracket attached to the fuel filler door.

When refueling, insert the filler nozzle completely into the filler pipe. Pulling the nozzle out of the pipe during refueling

- ▷ results in premature pump shutoff
- ▷ and will reduce the effect of the vapor recovery system on the pump.

The fuel tank will be full whenever the filler nozzle has been used properly and shuts off the first time.

Tank capacity: refer to page [185](#).

 Close the fuel cap carefully after refueling until a "click" is heard. While closing, be sure not to squeeze the strap which is fastened to the cap. A loose or missing cap will activate the Service Engine Soon lamp. ◀

## Fuel specifications

Use unleaded gasoline only.

Recommended fuel: premium with a minimum octane rating of 91 AKI.

BMW engines are equipped with knock sensors and will adapt automatically to different octane ratings, provided that the minimum octane requirement (87 AKI) is met.

Fuels with higher octane ratings will provide enhanced performance and lower fuel consumption, while the use of fuels with low octane ratings will have the opposite effect.

 Do not use leaded fuels. The use of leaded fuels will cause permanent damage to the system's oxygen sensor and the catalytic converter. ◀

AKI = Anti Knock Index

## Tire inflation pressure



You will find the inflation pressures on the inside door pillar (visible with door open).

### Check tire pressures

All pressure specifications are stated in psi (kilopascal) with cold tires (cold = ambient temperature). Refer to the next page as well.

For vehicles with Tire Pressure Control (RDC)\*:

After correcting the tire inflation pressure, reactivate the system. Refer to page [89](#).



Check tire inflation pressures regularly – at least every two weeks and before beginning a longer trip. Otherwise, incorrect tire pressure can lead to driving instability or to tire damage and accidents. Check the tire pressure in the space-saver tire as well. ◀

## 28 Tire inflation pressure

### Observe tire approval specifications

The inflation pressures in the table apply to tires made by BMW-approved manufacturers. Your BMW center is familiar with these pressures. Higher pressures may be specified for tires made by other manufacturers. Approved tire sizes are listed on page [128](#).

Your vehicle is equipped with tires that meet US and European standards. We recommend the exclusive use of BMW-approved tires.

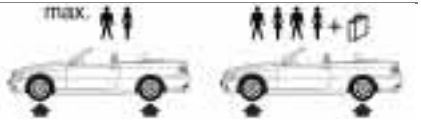
BMW	Tires All pressure specifications in the table are indicated in psi (kilopascal) with cold tires (cold = ambient temperature)				
323Ci	All summer tires as well as extra-load tires	30 (220)	33 (230)	36 (250)	44 (300)
	Winter tires	33 (230)	36 (250)	39 (270)	46 (320)
	Space-saver tire	61 (420)			

For all-season tires, use the same tire inflation pressure as for summer tires.



**Opening and closing:**

- Keys 32
- Electronic vehicle immobilizer 33
- Central locking system 34
- Opening and closing – from outside 34
- Opening and closing – from inside 38
- Luggage compartment lid 39
- Luggage compartment 40
- Alarm system 42
- Electric power windows 44
- Manual convertible top 45
- The fully automatic convertible top 49
- Wind deflector 51

**Adjustments:**

- Seats 53
- Seat and mirror memory 57
- Steering wheel 58
- Mirrors 58
- Car Memory, Key Memory 60

**Passenger safety systems:**

- Safety belts 61
- ISOFIX Attachment of the child seat 62
- Airbags 63
- Child restraints 66
- Installing a child restraint system 67
- Rollover protection system 68



**Driving:**

- Steering/Ignition lock 70
- Starting the engine 70
- Switching off the engine 71
- Parking brake 72
- Manual transmission 73
- Automatic transmission with Steptronic 74
- Turn signal indicator/Headlamp flasher 77
- Washer/Wiper system/  
Rain sensor 77
- Rear window defroster 79
- Cruise control 80

**Everything under control:**

- Odometer 82
- Tachometer 82
- Energy Control 82
- Fuel gauge 83
- Coolant temperature gauge 83
- Service Interval Display 83
- Check Control 84
- Clock 84
- Onboard computer 85

**Technology for safety and convenience:**

- Park Distance Control (PDC) 87
- Dynamic Stability Control (DSC) 88
- Tire Pressure Control (RDC) 89

**Lamps:**

- Parking lamps/Low beams 91
- Instrument lighting 91
- High beams/Parking lamps 92
- Fog lamps 92
- Interior lamps 92
- Reading lamps 93

**Controlling the climate for pleasant driving:**

- Automatic climate control 94
- Seat heating 99

**Cabin conveniences:**

- Glove compartment 99
- BMW Universal Transmitter\* 100
- Storage compartments 102
- Cellular phone 103
- Ashtray front 103
- Cigarette lighter 104
- Ashtray rear 104

**Loading and transporting:**

- Ski bag 105
- Cargo loading 106
- Luggage rack for the hardtop 108

**Overview****Controls and features****Operation, care and maintenance****Owner service procedures****Advanced technology****Technical data****Index**

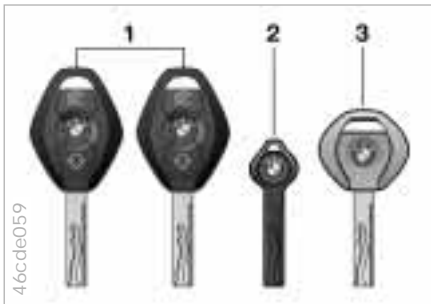

- 1 The master keys with remote control determine the functions for the Key Memory, refer to page [60](#)

 There is an extended-life battery in every master key that is charged automatically in the steering lock as you drive.

If you have a master key that is not being used, use that key at least once a year by driving with it for an extended period to recharge the battery. Refer also to page [35](#). ◀

- 2 Keep your spare key in a safe place, such as in your wallet. This key is not intended for continuous use

### 3 Door and ignition key

The locks for the luggage compartment lid and the glove compartment cannot be operated with this key – this is recommended for valet parking, for instance.

### Replacement keys

Replacement keys are available exclusively through your BMW center. Since the keys are part of a security system, vehicle ownership must be checked before a replacement key can be issued (refer to "Electronic Vehicle Immobilizer" on page [33](#)).

 If possible, take all of the master keys that belong to the vehicle with you when you pick up your replacement key. After getting a replacement key, turn it to position 2 in the ignition lock once (ignition switched on) and then back. This allows the passive anti-theft system to "learn" the new key. ◀



# Electronic vehicle immobilizer



## How the electronics work

At the heart of this system is an electronic chip that is integrated into the key. The lock mechanism itself is actually a dual-function device. While the engine is running, the circuitry in the ignition key and the vehicle's electronic system constantly exchange variable, vehicle-specific signals. The system will not release the ignition, fuel injection and starter unless it recognizes an "authorized" key.

## The key to security

Your BMW is equipped with a passive anti-theft system. This electronic immobilization system reduces the likelihood of your vehicle being stolen by making it impossible to start the engine using any keys other than the ones furnished with the vehicle. Your BMW center can cancel the electronic system authorization for individual keys (in the event of loss, for instance). A deactivated key can no longer be used to start the engine.



Force applied to the key can damage the integrated electronic circuitry. A damaged key can no longer be used to start the engine. ◀

**The concept**

The central locking system is ready for operation whenever the driver's door is closed. The system engages and releases the locks on the

- ▷ doors
- ▷ luggage compartment lid
- ▷ fuel filler door
- ▷ glove compartment.

The central locking system can be operated

- ▷ from outside via the door lock and using the remote control
- ▷ from inside by pressing a button.

Activating the central locking system from inside does not lock the fuel filler door (refer to page 38). Operating it from the outside simultaneously activates the anti-theft protection. Both the door locks and release handles remain locked. The alarm system\* is also armed or disarmed.

In the event of an accident, the central locking system unlocks automatically (only those doors that were not locked separately with the safety lock buttons). Refer to page 38. In addition, the hazard warning flashers and interior lamps come on.

**Using the key**

Turning the key in the driver's door once unlocks the driver's door only. Turning the key a second time unlocks all of the remaining doors, the luggage compartment lid, the fuel filler door and the glove compartment.



You can have a signal set as an acknowledgement message that the vehicle is closed correctly. ◀

**Convenience operating mode**

You can also operate the power windows and the fully automatic convertible top\* using the door lock.

- ▷ To open: with the door closed, turn the key to the "Unlock" position and hold it
- ▷ To close: with the door closed, turn the key to the "Lock" position and hold it.



Watch during the closing process to make sure that nobody is injured accidentally. Releasing the key stops the operation. ◀

**Manual operation**

(in the event of electrical malfunction)

Turn the key all the way to the extreme left or right to unlock/lock the door.

## Opening and closing – from outside

### Using the remote control

The remote control gives you an exceptionally convenient method for unlocking and locking your vehicle. Furthermore, it provides two additional functions that only the remote control can execute:

▷ Switching on the interior lamps  
Using this function, you can also "search" for your vehicle e.g. whenever it is parked in an underground garage

▷ Opening the luggage compartment lid

It will open slightly, regardless of whether it was previously locked or unlocked.

When you unlock the vehicle, the anti-theft system is deactivated, the alarm system\* is disarmed, and the interior lamps are turned on. When you lock the vehicle, the systems are activated and armed, and the lamps go off.

 You can have a signal set as an acknowledgement message that the vehicle is closed correctly. ◀



### Master keys

Keys with remote control are master keys. Refer to page 32.

 Children might be able to lock the doors from the inside. For this reason, always take the vehicle keys with you so that the vehicle can be opened again from the outside at any time. ◀

 Master keys that are used repeatedly are always ready for operation since the battery in the key is charged automatically in the steering lock as you drive.

If it is no longer possible to lock the vehicle via the remote control, the battery is drained. Use this key while driving for an extended period in order to recharge the battery. Refer also to page 32.

To prevent unauthorized use of the remote control, surrender only the door and ignition key or the spare key (refer to page 32) when leaving the vehicle for valet parking, for example.

In the event of a system malfunction, please contact your BMW center. You can also obtain replacement keys there. ◀

## 36 Opening and closing – from outside



If the vehicle is in a tight parking space, lowering the driver's side window helps you when entering the vehicle. After the door is closed, the driver's-side window closes automatically.

### **To lock and secure**

Press button 2.

### **Convenience opening mode**

Press and hold button 1. The power windows are opened.

### **To unlock the vehicle**

Press button 1 to unlock the driver's door only.

Press the button twice in order to unlock the entire vehicle.



## Switching on the interior lamps

After locking the vehicle, press button 2 again.

## Switching off the tilt sensor alarm system\* and interior motion sensor\*

Press button 2 again immediately after locking.

For additional information, refer to page 43.



## Opening the luggage compartment lid

Press button 3.

The luggage compartment lid will open slightly, regardless of whether the lid was previously locked or unlocked.

 Before and after a trip, be sure that the luggage compartment lid was not opened unintentionally. ◀

## System interference

The proper functioning of the remote control system may be affected by other units or equipment operating in the immediate vicinity of your vehicle.

If this should occur, you can still open and close the vehicle using the master key in both the door and luggage compartment locks.

## For US owners only

The transmitter and receiver units comply with part 15 of the FCC (Federal Communication Commission) regulations. Operation is governed by the following:

FCC ID: LX8EWS  
LX8FZVS  
LX8FZVE

## Compliance statement:

This device complies with part 15 of the FCC Rules. Operation is subject to the following two conditions:

- ▷ This device may not cause harmful interference, and
- ▷ this device must accept any interference received, including interference that may cause undesired operation.

 Any unauthorized modifications or changes to these devices could void the user's authority to operate this equipment. ◀



Use this button to operate the central locking system when the doors are closed. The doors and luggage compartment lid are unlocked or locked only. The anti-theft alarm system is not activated.



If only the driver's door was unlocked from the outside and you press the button, then, while the driver's door remains open, all the other doors, the luggage compartment lid, fuel filler door and the glove compartment will open as well.

If the driver's door is closed, it will be locked. ◀



The central locking system can be locked automatically as soon as you begin to drive if you desire. You may also have this adjusted so that it is key-specific. ◀

### To unlock and open the doors

- ▷ Either unlock the doors together with the button for the central locking system and then pull each of the release handles above the armrests or
- ▷ pull the release handle for each door twice: the first pull unlocks the door, and the second one opens it.

### To engage the locks

- ▷ Either use the central locking button to lock both doors, or
- ▷ press the individual safety lock buttons down. As an added design feature to prevent the driver from being inadvertently locked out of the vehicle, the driver's door safety lock button will not engage as long as the door is open.



Children might be able to lock the doors from the inside. For this reason, take the vehicle's keys with you so that the vehicle can be opened again from the outside at any time. ◀

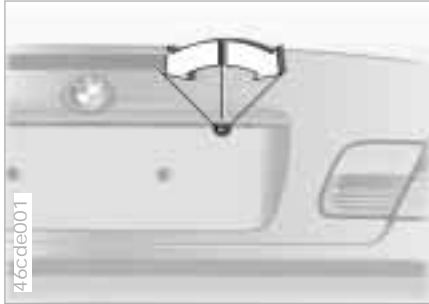

## The lock

Only the master keys (refer to page 32) fit in the lock of the luggage compartment lid.

## To secure separately

Lock the glove compartment with a master key.

This locks the luggage compartment lid and disconnects it from the central locking system. If you then surrender only the door and ignition key (refer to page 32), access to the vehicle through the luggage compartment is not possible, which is an advantage when using for valet parking, for instance.



## To open from inside

If the luggage compartment lid has not been locked separately, you can open it with this button in the footwell on the driver's side when the vehicle is stationary.



## To open from outside

Press the button in the handle recess (arrow): the luggage compartment lid opens slightly.

The luggage compartment is lit when the luggage compartment lid is opened.

## Manual operation

(in the event of electrical malfunction)  
Turn the master key to the left to the stop – the luggage compartment lid will open slightly.

The luggage compartment is locked again as soon as you close the lid.

## 40 Luggage compartment lid

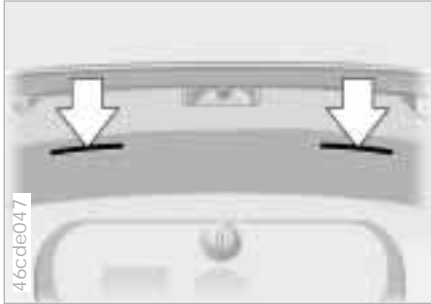

### Closing

The handle recesses in the interior trim panel of the luggage compartment lid (arrows) make it easier to pull down.

 To avoid injuries, be sure that the travel path of the luggage compartment lid is clear when it is closed, as with all closing procedures. ◀

 Do not drive with the luggage compartment lid open, since exhaust fumes could penetrate the interior of the vehicle. If you still drive with the luggage compartment lid open (with the convertible top closed):

- ▷ Close all the windows
- ▷ Increase the airflow of the automatic climate control to a high level. Refer to page 94. ◀

## Luggage compartment



### Hanging the luggage compartment floor up by the hook

- 1 Press the button (arrow)
- 2 Pull it up by the handle





Lashing eyes are located on the inside corners of the luggage compartment for attaching luggage nets\* or elastic straps so that you can secure your luggage.

Refer also to "Cargo loading" on page [106](#).

- 3 Lift the floor panel up with the device designed to hold it and hook it onto the rubber seal of the water gutter (arrow).

 When lowering, carefully press the device used for hanging the floor panel back into its holder. ◀

## Increasing the space in the luggage compartment

You can increase the space in the luggage compartment with the convertible top closed. To do this, flip the handle (arrow) outward, and press it downward. Now the convertible top compartment panel has been raised up.

Reverse the process to get ready to open the convertible top.

 When opening the convertible top, make sure that the luggage compartment is properly set up for this; refer to page [45](#) or [49](#), otherwise, you could incur damage. ◀

## 42 Alarm system\*

### The concept

The vehicle alarm system responds:

- ▷ When a door, the hood or the luggage compartment lid is opened
- ▷ Movements inside the vehicle
- ▷ To a change in the vehicle's tilt – if someone attempts to steal the wheels or tow the vehicle without authorization, for example
- ▷ If there is an interruption of battery voltage.

The system responds to unauthorized vehicle entry and attempted theft by simultaneously activating the following:

- ▷ Sounding an acoustical alarm for 30 seconds
- ▷ Activating the hazard warning flashers for approx. five minutes
- ▷ Flashing the high beams on and off in tandem with the hazard warning flashers.

### To activate and deactivate the alarm system

When the vehicle is locked or unlocked by using a key or the remote control, the alarm system is also armed or disarmed at the same time.

The interior protection and tilt sensor alarm systems are activated approx. 30 seconds after you have shut the last door.

If the alarm system has been armed correctly, the hazard warning flashers flash once.

 You can have one signal set as acknowledgment when arming and disarming. ◀

You can also open the luggage compartment lid when the system is armed by pressing button 3 of the remote control (refer to page 37). When it is closed, the lid is once again secured.



### Indicator lamp displays

The indicator lamp is located under the inside rearview mirror.

- ▷ When the indicator lamp flashes continuously, the system is armed
- ▷ The indicator lamp flashes when it is armed. Doors, the hood or luggage compartment lid are not closed properly. Even if you do not close the alerted area, the remaining areas are deadlocked, and the indicator lamp flashes continuously after 10 seconds. However, the interior protection system is not activated
- ▷ If the indicator lamp goes out when the system is disarmed, no manipulation or attempted intrusions have been detected in the period since the system was armed

## Alarm system\*

- ▷ If the indicator lamp flashes for 10 seconds when the system is disarmed, an attempted entry has been detected in the period since the system was armed.

Following triggering of an alarm, the indicator lamp will flash continuously.

### Avoiding an unintentional alarm

The tilt sensor alarm system and interior protection system can be deactivated. Doing this prevents a false alarm from being triggered (in garages with elevator ramps, for instance), or when the vehicle is transported by trailer or train:

Lock the vehicle twice (= arm the system). Press button 2 on the remote control twice in succession or lock the vehicle twice with the key (refer to page 34).

The indicator lamp lights up briefly and then flashes continuously. The tilt sensor alarm system and interior protection system are deactivated until canceled.

Re-arm the anti-theft alarm system to re-activate the tilt sensor alarm system and interior protection system.

### Interior protection system

The transmitter and receiver of the interior protection system are located in the front area of the center console, hidden from the driver, and in the rear area of the center console under a cap.

However, deactivate the interior protection system (see previous column) when children or animals are to remain in the vehicle.

### For US owners only

The transmitter and receiver units comply with part 15 of the FCC (Federal Communication Commission) regulations. Operation is governed by the following:

FCC ID: LTQSDR2G5

Compliance statement:

This device complies with part 15 of the FCC Rules. Operation is subject to the following two conditions:

- ▷ This device may not cause harmful interference, and
- ▷ this device must accept any interference received, including interference that may cause undesired operation.

 Any unauthorized modifications to these devices could void the user's authority to operate the equipment. ◀

## 44 Electric power windows



### Open and close the windows

From ignition key position 1:

- ▷ Press the switch up to but not past the pressure point:  
The window continues to move downward as long as you continue to hold the switch
- ▷ Press the switch past the pressure point:  
The window moves automatically. Pressing the switch again stops the opening cycle.

You can close windows in the same manner by pulling the switch.



### Operating all side windows

- ▷ Press the switch up to but not past the pressure point:  
All the windows will continue to lower as long as you keep pressing the switch
- ▷ Press the switch past the pressure point:  
All the windows move automatically. Pressing the switch again stops the opening cycle.

You can close all the windows by pulling the switch.

After the ignition has been switched off: You can still operate the electric windows for up to 15 minutes, provided that no door has been opened.

 Remove the key from the ignition lock and close the doors when you leave the vehicle, so that children cannot operate the power windows and possibly injure themselves. ◀

For operating convenience by using the door lock, refer to page 34.

## Manual convertible top

The fabric top offers perfect weather protection, and can easily be opened and closed by one person.

Here are a few tips to ensure that you get the most enjoyment out of driving your convertible. It is advisable to close the convertible top when the vehicle is parked. The closed convertible top not only protects the passenger compartment from unforeseeable damage from the weather, it also provides a certain degree of theft protection.

In addition, keep valuables only in the locked luggage compartment, even with the convertible top closed.

Never mount a roof-mounted luggage rack on the convertible top.

 To close the power side windows while driving: be sure to close either the rear windows first, or all windows at the same time, otherwise, they may not close all the way at higher speeds. ◀



### To open the convertible top

 Operate the convertible top only when the vehicle is stationary. To prevent damage, the convertible top compartment lid can not be opened if the luggage compartment lid is open. ◀

- 1 Flip the locking handle out and turn it until it hits the end stop
- 2 Raise the convertible top slightly (reduces the tension)



- 3 Press the button to unlock the top. The lid locks for the convertible top are unlocked and the side windows lower slightly

 If the convertible top compartment lid has been raised, then the lid locks for the convertible top will be blocked. If the indicator lamp lights up when you press the button, then you cannot unlock. Flip the convertible top compartment lid down; refer to page 41, and close the luggage compartment lid. ◀

## 46 Manual convertible top

 Starting from either ignition key position 1 or if with a door open: if the side windows are closed, lower them slightly by pressing the unlocking button. ◀



4 Position the rear convertible top bar vertically and hold it firmly

 You can support the rear convertible top bar when you raise it by pressing on the indicated area (arrow). ◀



5 Open the convertible top compartment lid all the way

6 Lay the rear convertible top bar in the convertible top compartment

7 Lift the convertible top off in the front and then lay it down in the back

 Press the convertible top completely into the compartment. This makes it easier to close the convertible top compartment lid, especially at low temperatures. ◀

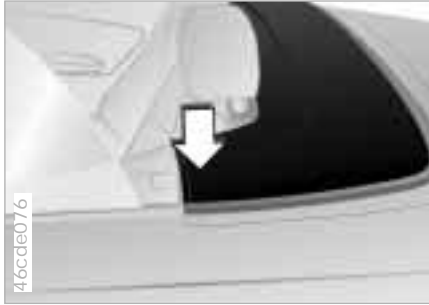

The central locking system unlocks automatically when the convertible top compartment lid is closed, i.e., the luggage compartment lid is no longer locked and can be opened again.



To avoid any damage from constant damp, never recess the convertible top while it is wet (refer to the chapter "Care" beginning on page 144). ◀



- 8 Press the convertible top compartment lid down from above (arrow). The lid locks for the convertible top compartment are equipped with sensors that carry out the closing procedure
- 9 Close the windows that were slightly lowered, or position them at the desired height.



In order to avoid any pinching, move the convertible top compartment lid from above only. To prevent damage, the convertible top compartment lid can not be opened if the luggage compartment lid is open. ◀

## To close the convertible top

- 1 Put the ignition key in position 1
- 2 Press the button to unlock the top. The lid locks for the convertible top are unlocked and the side windows lower slightly
- 3 Open the convertible top compartment lid
- 4 Lift out the convertible top by both the lateral guide section and the front convertible top frame, and swing it toward the front until you feel some resistance

## 48 Manual convertible top

 Starting from either ignition key position 1 or with a door open: If the side windows are closed, lower them slightly by depressing the respective button. After closing the convertible top, either close the side windows or put them at the height desired. ◀

- 5 Do not position the rear convertible top bar vertically until the convertible top has been swung forward as far as possible
- 6 Press the convertible top compartment lid down from above. The lid locks for the convertible top are equipped with sensors that carry out the closing procedure

 In order to avoid any pinching, move the convertible top compartment lid from above only. ◀

 The central locking system automatically unlocks when the convertible top compartment lid is closed, i.e., the luggage compartment lid is no longer locked and can be opened again. ◀

7 Using the locking handle, pull the front convertible top frame onto the windshield frame, and lock the convertible top by turning the handle until you hear it engage

- 8 Close the windows that were slightly lowered, or position them at the desired height.

The rear convertible top bar will be automatically pressed onto the convertible top compartment lid, and because of the pressure, will be sealed off when closed.

 Should the convertible top start to flutter at higher speeds, increase the airflow into the passenger area via the ventilation controls to avoid creating a vacuum. ◀



## The fully automatic convertible top\*

The fully automatic convertible top combines assured protection from the weather with a one-touch operation. Here are a few tips to ensure that you get the most enjoyment out of driving your convertible.

It is advisable to close the convertible top when the vehicle is parked. The closed convertible top not only protects the passenger compartment from unforeseeable damage from the weather, it also provides a certain degree of theft protection. In addition, keep valuables only in the locked luggage compartment, even with the convertible top closed.

Never mount a roof-mounted luggage rack on the convertible top.

To prevent damage, do not operate the convertible top at temperatures below 14 °F (-10 °C).

To conserve the battery, operate the convertible top only with the engine running if at all possible.

 The convertible top operation is completely automatic. In rare instances, some manual support may be necessary (see Note in next column but one).

Operate the convertible top only when the vehicle is stationary. Do not start to drive while operating it, either, because the procedure could be interrupted when the top hits certain positions. A partially open convertible top can lead to damage or injury.

If you initiate convertible top operation with the vehicle stationary and then start driving, e.g. at a traffic light, you can completely carry out the initiated operation. To do this, press and hold the corresponding button again. Give the respectively applicable traffic rules preference during convertible top operation, as otherwise you will be in violation of the law.

Remove any foreign objects from the windshield frame before closing the convertible top, otherwise, they could hinder the opening and closing of the convertible top.

Do not place any objects on the convertible top, since they would fall off when the convertible top is operated and cause damage or injuries.

While driving, always close the rear power windows first, or close all 4 windows at the same time, otherwise the windows may not shut tightly at higher speeds. ◀



Do not reach into the convertible top mechanism during opening and closing. Keep children away from the moving parts of the convertible top during operation.

The automatic process is immediately interrupted if the button for actuating the convertible top is released. The process can be continued in the direction desired by pressing the switch. ◀



If the convertible top has been stored in the convertible top compartment for an extended period of time, e.g. during the winter months because the hardtop\* has been used, it may be necessary to manually support the top when closing it automatically for the first time:

Should the convertible top stop shortly before it reaches the end of the closing operation, press from outside against the front of the convertible top frame while pressing the switch to help the top along until it begins moving again on its own. ◀



### Opening and closing

- 1 Closing
- 2 Opening

Keep pressing the button for operating the convertible top until the opening or closing process has ended.

The side windows will lower slightly during the opening process. If you continue to press the button after the convertible top has been closed and locked, the side windows will close, too.

The red indicator lamp lights up while the convertible top is being operated. After releasing the button, the lamp will start blinking if the opening or closing process has not been fully completed.

If the convertible top compartment panel has been raised, then the convertible top cannot be moved. In this event, the yellow indicator lamp stays on when the button is pressed and indicates that it is not possible to operate the convertible top.

Flip the convertible top compartment panel down, refer to page 41.

 If the opening or closing process has been interrupted, then the convertible top will remain stationary in that position for 15 minutes.

After that, the convertible top can be operated manually. This can also be carried out with the ignition key in position 0.

The luggage compartment cannot be opened while operating the convertible top.

The side windows are lowered slightly when pressing the convertible top button and are raised back up after completing the opening process, if you have continued holding the button down for more than 2 seconds after the indicator lamp has gone out. ◀

 While the convertible top is moving, the side windows lower slightly. If the convertible top closing or opening operation is interrupted, do not close the side windows by using the power window buttons.

Sometimes the luggage compartment lid cannot be opened, either, if the opening or closing process has been interrupted.

To avoid any damage from constant damp, never put the convertible top away wet.

The rear window will move toward the passenger area while the convertible top is in operation, and it will also lightly press the heads of the passengers sitting in the rear toward the front. As a rule, there is no danger in this. To avoid any possible pinching, however, the rear passengers should tilt their heads slightly forward while the convertible top is in motion. ◀

## The fully automatic convertible top\*

### Convenience operation from the driver's door lock

- ▷ To open: with the door closed, turn the key to the "Unlock" position and hold it
- ▷ To close: with the door closed, turn the key to the "Lock" position and hold it.

Releasing the key stops the movement.

For safety reasons, to keep the closing process in view, you cannot use the remote control for convenience operation.

 At higher speeds, the lower air pressure in the passenger compartment may create a vacuum and cause the convertible top to start fluttering. Increase the air supply via the ventilation controls so that a vacuum does not occur in the vehicle. ◀

## Wind deflector\*

51

The wind deflector cuts down air turbulence within the passenger area, thus affording a pleasant ride, even at higher speeds. It is delivered in a protective casing, and because of its minimal size, can easily be stowed in the luggage compartment.

### Installation

- 1 Take the wind deflector out of its protective casing

## 52 Wind deflector\*



- 2 Flip out the side pieces on both sides and lock them into place (arrow)



-  Position the wind deflector so that the smaller portion points toward the front. ◀

- 3 Guide the mounting pin for the side part into the opening provided
- 4 Using the slide, pull the mounting pin on the other side back, so that it can be guided into the opening provided
- 5 Unlock the convertible top compartment lid, refer to page 45 or 50, and open the convertible top compartment lid
- 6 Flip the rear half of the wind deflector back so that the attachments are in contact with the vehicle
- 7 Close the convertible top compartment lid. The wind deflector has now been attached and is theft-proof.



To avoid any pinching, move the convertible top compartment lid from above only.

With wind deflector in place: never push the front seat all the way back to avoid damage to the wind deflector. ◀

### Removing

Remove the wind deflector in the opposite order of installation.

## Seat adjustment

For your personal safety when adjusting the seat position, please follow the instructions below carefully.

**⚠** Never try to adjust your seat while driving the vehicle. The seat could respond with an unexpected movement, and the ensuing loss of vehicle control could lead to an accident.

Be sure that the safety belt remains firmly against your body at all times. In the event of a frontal impact, a loose lap belt could slide over the hips, leading to abdominal injury. In addition, the safety belt's restraint effectiveness is reduced if the belt is worn loosely.

Never ride with the backrest reclined to an extreme angle (this particularly applies to the front passenger). If you do so, there is a risk that you will slide under the safety belt in an accident, thus reducing the protection provided by the safety belt. ◀

### Correct sitting posture

To reduce strain on the spinal column, sit all the way back in the seat and rest your back fully against the backrest. In the ideal sitting posture, your head is positioned along a straight line in relationship to your spinal column. For long-distance driving, you may wish to increase the backrest tilt-angle slightly to reduce muscular tension. You should be able to grasp the steering wheel at its highest point with your arms slightly bent.



- 1 Backward/Forward adjustment
- 2 Cushion height
- 3 Backrest angle

**⚠** Comply with the adjustment instructions on this page, otherwise, personal safety is diminished. ◀

## 54 Head restraints



### Front head restraints

#### 1 Height



Head restraints reduce the risk of spinal injury in the event of an accident.

Adjust the head restraint so that its center is approximately level with your ears.

To avoid injury when moving the head restraint, do not hold on between the head restraint and the backrest's upper edge. ◀



#### 2 Tilt angle

Manually position the head restraint as desired.



### Rear head restraints



Rear head restraints may only be lowered if there are no passengers in the back seat. Raise lowered head restraints again before taking on passengers in the back seat. ◀

To completely lower the rear head restraints:

- 1 Press the button down (arrow) and keep it pressed
- 2 Push down on the top of the head restraint.

## Head restraints

### Raising the head restraints

Keep pulling on the head restraints until they click into place.

 Do not remove the rear head restraints, as otherwise they will be damaged. ◀

For additional information, please contact your BMW center.

 Do not use the rear head restraints as a shelf. Always keep the travel path for the rollover protection system free and clear. Never attach any type of protective coverings to the head restraint (also refer to the labeling on the head restraints). ◀

## BMW sports seat\*



- 1 Tilt angle
- 2 Backward/Forward adjustment
- 3 Cushion height
- 4 Backrest angle

 Comply with the adjustment instructions on page 53. Failure to do so could result in diminished personal safety. ◀



- 5 High support area:  
Pull the lever and adjust the position of the cushion for thigh support as desired.

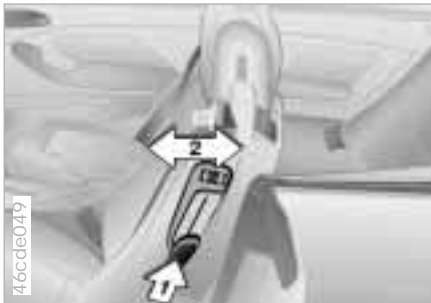



The seat-integrated safety belt system ensures easier access to the back seat. It is not necessary to adjust anything on the safety belt system. It automatically adjusts to different body sizes.

- 1 Pull up the lever (1) and tip the backrest forward
- 2 Press the button (2) in the driving direction and keep it pressed until the seat has moved into the desired position.

 The backrest can be locked while tipped forward. This is practical, for example, when entering the back seat on a hill. To do this, press against the backrest until it clicks into place. It does not need to be released with the lever (1) to tip it back into place again. ◀

If you tip the backrest back into place and hold the button (2) pressed opposite the driving direction, the seat moves back into the previous position.

 If the button (2) is released beforehand, the seat stops in the respective position. It does not need to be released with the lever (1) to tip it back into place again. ◀

 Lock both back restraints while driving, otherwise there is a danger of an unexpected movement causing an accident. ◀

## Lumbar support\*



You can adjust the backrest's contour for additional support in the curvature of your spine's lumbar region.

The upper hips and spinal column receive supplementary support to help you maintain a relaxed, upright posture.

- ▷ Press front/rear of switch:  
Increase/decrease curvature
- ▷ Press the upper/lower end of the switch:  
Increase the upper/lower curvature.



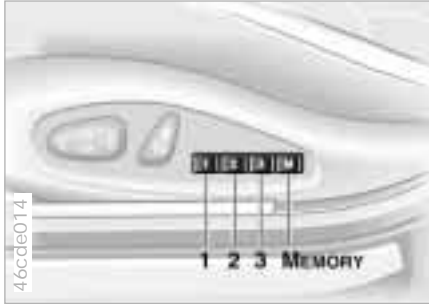

You can store and recall three different driver's seat and outside mirror positions. The illustration shows the buttons on the driver's seat, for making these position adjustments.

 The setting for the head restraint is stored in memory, but the setting for the lumbar support is not. ◀

## To store

- 1 Turn the key to ignition key position 1 or 2
- 2 Set the desired positions for the seat, head restraint and outside mirror
- 3 Press the **MEMORY** button: the indicator lamp in the button lights up
- 4 Press memory button 1, 2 or 3, as desired. Indicator lamp goes out.

## To select a stored setting

Convenience function:

- 1 Open the driver's door after unlocking or set the ignition key in position 1
- 2 Briefly press memory button 1, 2 or 3, as desired.

The adjustment cycle is canceled immediately if you press a seat adjustment switch or one of the memory buttons.

Security function:

- 1 With the driver's door closed and the ignition key either removed or in position 0 or 2
- 2 Maintain pressure on the desired memory button (1, 2 or 3) until the adjustment process is completed.

If you press the **MEMORY** button accidentally: press the button again; the indicator lamp goes out.

 Do not select a memory position while the vehicle is moving. If you do so, there is a risk of accident from unexpected seat movement. ◀

 Your BMW center can adjust your vehicle's systems in such a manner that your personalized settings are automatically set for the seat, head restraint and outside mirror positions when you unlock the vehicle with your personal remote control. ◀

 If you make use of this method of adjustment, be sure that the footwell behind the driver's seat is unobstructed before unlocking the vehicle. If you fail to do so, any persons or objects behind the seat could be injured or damaged by a rearward movement of the seat. ◀

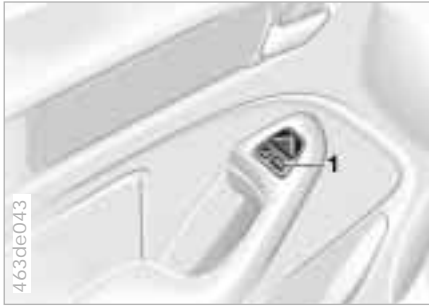

**Passenger side exterior mirror tilt function**

(automatic curb monitor)\*

- 1 Move the mirror selector switch 1 to the "driver's mirror" position
- 2 When the selector lever is placed in "Reverse", the passenger-side mirror tilts downward. This allows the driver to see the area directly adjacent to the vehicle during parking (curbs, etc.).

You can deactivate this automatic feature by setting the mirror selector switch to the "passenger side" position.



- 1 Push the locking lever downward
- 2 Adjust the steering wheel for your seating position
- 3 Pull the lever back in to clamp the steering wheel in the new position.

 Do not adjust the steering wheel while the vehicle is moving. If you do so, there is a risk of accident from unexpected movement. ◀

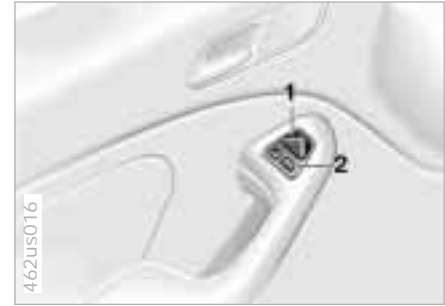

**Exterior mirrors**

- 1 Switch for 4-way adjustment
- 2 Selector switch for changing between mirrors

## Mirrors

You can also adjust the mirrors manually by pressing against the outer edges of their lenses.

 The mirror on the passenger's side features a lens with a more convex surface than the mirror installed on the driver's side. When estimating the distance between yourself and other traffic, bear in mind that the objects reflected in the mirror are closer than they appear. Estimating the distance between you and the traffic behind you is therefore imprecise. ◀

### Electric defrosting

Both mirrors are automatically defrosted with the ignition key in position 2.



### Interior rearview mirror

To reduce glare from behind when driving at night, turn the knob.

### Sun visors

These can be folded down toward the windshield or swiveled out against the side windows.



### Inside rearview mirror with automatic dimming feature\*

By responding to the effects of ambient light and the glare from following traffic, this mirror automatically dims through an infinitely variable range.

The mirror switches to its clear, undimmed mode whenever the transmission is placed in reverse gear (selector lever in "Reverse").

For proper functioning of the mirror, be sure that the two photocells are unobstructed and clean. One of the photocells (arrow) is positioned in the mirror's glass, while the other is slightly offset on the opposite side of the mirror.

For an explanation of the electro-chromic technology used in this mirror, refer to page [175](#).



### How the system functions

You have probably frequently wished that you could configure individual functions of your vehicles to reflect your own personal requirements. In engineering your vehicle, BMW has included several user-defined functions in the vehicle's design. Your BMW center can make these settings for you in accordance with your wishes.

There are settings related to the vehicle ("Car Memory") and settings related to individuals ("Key Memory"). You can have up to four different basic settings adjusted for four different persons. The only requirement is that each person uses his or her own remote control key.

When your vehicle is unlocked with the remote control, the vehicle recognizes the individual user by means of a data exchange with the key, and makes adjustments accordingly.

In order for you to distinguish between different keys, colored decals are supplied together with the keys.

### What the system can do

Your BMW center can provide you with details on the capabilities of the Car Memory and Key Memory systems.



You will see this symbol throughout the Owner's Manual. It is to remind you at appropriate places of the settings that are available to you. ◀

An example of Key Memory is the automatic adjustment of the power driver's seat with stored settings for the individual person when the vehicle is unlocked.

## Safety belts



Fasten your safety belt at the beginning of every trip.

To fasten: make sure you hear the lock engage in the belt buckle.

To release: press the red button in the buckle. Hold the belt and guide it back into its reel.

 Before using the rear safety belts, take them out of their holder. ◀

 For your safety, comply with the following instructions for wearing safety belts. If you do not, the safety belts may not be able to provide their maximum protection. The following information also applies to your passengers: never allow more than one person to wear a single safety belt. Never allow infants or small children to ride in a passenger's lap.

Avoid twisting the belt while routing it firmly across your hips and shoulder. Do not allow the belt to rest against hard or fragile objects in your pockets. Do not route the belt across your neck, or run it across sharp edges and ensure that the belt does not become caught or jammed.

Be sure that the safety belt fits snugly against your body at all times, and avoid wearing clothing that prevents the belt from fitting properly. Pull on the belt periodically to readjust the tension over your shoulder. In the event of a frontal impact, a loose lap belt could slide over your hips, leading to abdominal injury. In addition, the safety belt's restraint effectiveness is reduced if the belt is worn loosely. Expectant mothers should always wear their safety belts, taking care to position the lap belt against the lower hips, where it will not exert pressure against the abdominal area.

To prevent undesired belt movements at high speeds, leave the safety belts for the back seat in their holders when they are not required. ◀

For child restraint system installation, refer to page [66](#).

For care instructions, refer to "Car care" on page [142](#).

 If the safety belt system has been subjected to the stresses involved in an accident or otherwise damaged: Have the entire safety belt mechanism replaced by your BMW center, including the safety belt tensioner. In addition, have your BMW center inspect the safety belt anchors. If a child restraint system was in the vehicle during an accident, consult the manufacturer's instructions regarding replacement. ◀

### Child restraint systems\*

 Never install a rear-facing child restraint system in the front passenger seat. If you do so, the child could be injured in an accident when the airbag is triggered. Do not modify the child restraint system in any way. If you do so, it will not provide your child with maximum protection. ◀

## 62 ISOFIX Attachment of the child seat\*

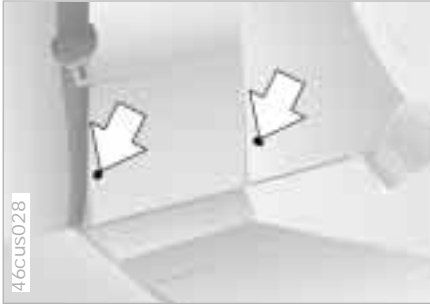

 To prevent undesired belt movements at high speeds, leave the safety belts for the back seat in their holders when they are not required. ◀

The mounts for the ISOFIX child restraint system are not visible from the outside, but are marked by 2 colored spots.

The illustration shows the left rear seat by way of example.

Please observe manufacturer service- and safety precautions when attaching the ISOFIX child restraint system.

Carefully press the brackets through the separating lines in the upholstery at the marked points.

# Airbags

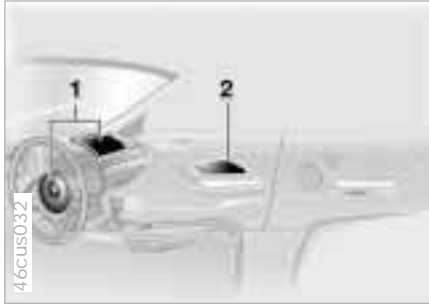

- 1 Front airbags for driver and passenger
- 2 Side airbags (front)

## Protective effect

The front airbags supplement the three-point safety belts by providing additional protection for the front-seat occupants in the event of a severe frontal collision in which the protection afforded by the belts alone may no longer be sufficient. The side airbags help provide protection in the event of a collision from the side. Each of the side airbags is designed to help support the upper body.

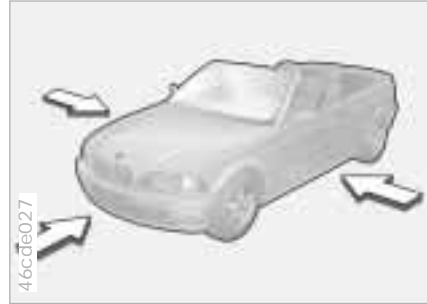

The illustration depicts schematically the primary directions of vehicle impact that initiate airbag deployment.

## Indicator lamp



The indicator lamp displays the operational status of the airbag system when the ignition key is in position 1 and up.

System operational:

- ▷ The indicator lamp comes on briefly then goes out.

System malfunction:

- ▷ The indicator lamp fails to come on
- ▷ The indicator lamp comes on briefly before going out and then lighting up again.

A system malfunction could prevent the system from responding to an impact occurring within its normal response range.

Please have your BMW center inspect and repair the system as soon as possible.

**Sitting correctly with airbags**

 For your safety, comply with the following instructions for the airbags. If you do not, the airbags may not be able to provide their maximum protection. All passengers in the vehicle should be aware of and comply with this information:

The airbags are supplemental restraint devices designed to provide extra protection; they are not a substitute for safety belts. Wear your safety belt at all times. The airbags will not be triggered in the event of a minor accident, a vehicle roll-over, or collisions from the rear. In these instances, the safety belt provides optimal protection.

Airbags are located under cover panels in the steering wheel, in the dashboard and in the side trim panels in the front. Adjust your seat to a position that provides maximum distance between you and the steering wheel, the instrument panel and the door while still allowing comfortable and safe access to all vehicle controls.

To avoid sustaining hand and arm injuries, always grasp the steering wheel on the rim with the hands at the 9 and 3 o'clock positions. Do not place your hands on the center pad.

Never allow any objects to obstruct the

area between the airbag and an occupant.

Do not use the cover panel above the passenger-side airbag as a storage area.

Do not apply adhesive materials to the cover panels of the airbags, cover them or modify them in any other way.

Do not install a rear-facing child restraint system in the front passenger seat of this car.

Children under 13 years of age and children less than 5 feet (150 cm) tall should ride only in the rear seat.

Infants or small children should never be held on the lap of a passenger.

If your car is equipped with side airbags in the rear passenger area, be sure that child restraints are mounted correctly and provided with the greatest-possible distance between the airbags in the side trim panels. Do not allow children to lean out of the child's seat in the direction of the side trim panels. If they do so, serious injuries can occur if the airbag is triggered. ◀



At all times, occupants should sit upright and be properly restrained (infants and small children in appropriate child restraint systems; larger children and adults using the safety belts). Never let an occupant's head rest near or on a side airbag because the inflating airbag could cause a serious or fatal injury. Please note that the word "Airbag" imprinted on the door trim panel indicates the airbag's location.

Accident research shows that the safest place for children in an automobile is in the rear seat. However, a child sitting in the rear seat and not properly restrained may place his or her head on or near the airbag, if so equipped. For example, a child – even though belted – may fall asleep with his or her head against the side airbag. It may be difficult for a driver to ensure that children in the rear seat will remain properly positioned at all times and not place their heads on or near the side airbag.

Therefore, we recommend that the rear seat side airbags, if so equipped, be deactivated if children will travel in the rear seat.

The rear seat side airbags may already have been deactivated, either at the time of manufacture or by a BMW center. Labels in the rear door opening



## Airbags

should indicate the status of your rear seat side airbags. If you are uncertain of their status, or wish to have the airbags activated or deactivated, please contact your BMW center. ◀

Even when all these guidelines are observed, there is still a small residual risk of injuries to the face, hands and arms occurring from airbag deployment in isolated instances. The ignition and inflation noise may provoke a mild temporary hearing loss in extremely sensitive individuals.

Airbag warning information is also provided on the sun visors.

For additional information concerning the airbag system, refer to pages [146](#) and [173](#).



This is the right way a child should sit in a child restraint when rear side airbags (arrow) are provided.



This is the right way a larger child should sit wearing the safety belt when rear side airbags (arrow) are provided.

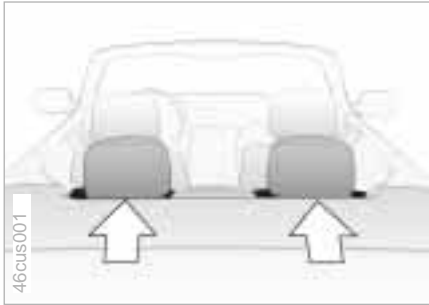

Commercially-available child restraint systems are designed to be secured with a lap belt or with the lap belt portion of a combination lap/shoulder belt. Improperly or inadequately installed restraint systems can increase the risk of injury to children. Always read and follow the instructions that come with the system.

If you use a child restraint system with a tether strap, two additional tether anchorage points (refer to the arrows in the illustration) have been provided. Depending on the location selected for seating in the rear passenger area, attach the tether strap to the corresponding anchorage point to secure the child restraint system.

If the respective seating position is fitted with a headrest lift the headrest and pass the tether strap between the headrest and the seat back.

Adjust the tether strap according to the child restraint manufacturer's instructions.



Before installing any child restraint device or child seat, please read the following:

Never install a rear-facing child restraint system in the front passenger seat of this vehicle.

Your vehicle is equipped with an airbag supplemental restraint system for the front passenger. Because the backrest on any rear-facing child restraint system (of the kind designed for infants under 1 year and 20 lbs./9 kg) would be within the airbag's deployment range, you should never mount such a device in the front passenger seat, since the impact of the airbag against the child restraint's backrest could lead to serious or fatal injuries.

If it is necessary for a child (not an infant) to ride in the front seat, certain precautions should be taken. First, move the passenger seat as far away from the dashboard as possible. This important precaution is intended to

maximize the distance between the airbag and the child. Older children should be tightly secured with a safety belt. Younger children should be secured in an appropriate forward-facing child restraint system that has first been properly secured with a safety belt. Never install a rear-facing child restraint system in the front passenger seat.

We strongly urge you to carefully read and comply with the instructions for installation and use provided by the child restraint's manufacturer whenever you use such a device.

Be sure that all occupants (of all ages) remain properly and securely restrained at all times. ◀

All rear seating positions in your vehicle meet the recommendations of SAE J1819, an industry-recommended practice for securing child restraint systems in motor vehicles.



## Lock the safety belt

Extract the entire length of the belt from the inertia reel mechanism. Allow the reel to retract the belt somewhat and engage the buckle, then tighten the belt against the child restraint system. The retraction mechanism is now locked. The belt cannot be extracted farther. Always comply with the installation instructions provided by the manufacturer of the child restraint system.

All of the rear belt retractors and the front passenger's safety belt can be locked for mounting and securing child restraint systems.

Information regarding this is located near the buckle latch of each safety belt.

## To release the belt

Release the buckle, remove the child-restraint device and allow the belt retractor to reel the belt completely in.

## 68 Rollover protection system

The rollover protection system is automatically activated in the event of an accident or other critical driving situation (extreme tilting along either the longitudinal or lateral axis, loss of ground contact). The protective bar located in the rear head restraints thrusts outward within fractions of a second.

In addition to the rollover bar that is integrated into the windshield frame, the rollover protection system provides all vehicle occupants with necessary headroom.

 Always keep the travel path for the rollover protection system free and clear. Never attach any type of protective coverings to the head restraints. In less serious accidents, your safety belt will protect you, and depending on the severity of the accident, the safety belt tensioner and the multi-stage air-bag restraint system will as well. ◀



If this safety feature is no longer needed after it has been automatically deployed, then the rollover protection system can be lowered again. No special tools of any kind are needed to do this.

1 Use a screwdriver from the onboard tool kit to remove the cover panel; position it under the notch (arrow)



2 Pull the lever (arrow) forward and keep it in this position



- 3 Push down on the protective bar (1) from above until you hear it click into place
- 4 Put the cover panel back in place, and press down on it hard
- 5 Push the back side of the head restraint (2) into position.

Repeat the process with the second protective bar. If you are not familiar with any of the procedures, consult your BMW center.

Have your BMW center check the rollover protection system if it ever triggers for no apparent reason.



Never move the convertible top after the rollover protection system has been triggered.

Do not use the rear head restraints as a shelf.

Do not make any alterations to any of the rollover protection system's individual components or its wiring.

Only your BMW center is authorized to carry out any work on the rollover protection system.

Work that is not done properly could lead to failure during an emergency or inadvertent triggering.

To ensure that the system check can be carried out properly, and to ensure long-term operation, do not deviate from the prescribed maintenance intervals. Maximum interval between rollover protection system maintenance is 2 years, and it must be carried out by your BMW center. ◀



### **0 Steering lock engaged**

The key can be inserted or removed in this position only.

After removing the key, turn the steering wheel slightly to the left or right until the lock engages.

 Vehicles with automatic transmission\*:

Do not move the selector lever from the "Park" position until the engine is running (ignition key at position 2).

In order to turn the key back to position 0 or to remove it, move the selector lever into position "Park" first (Interlock). ◀

### **1 Steering lock disengaged**

Turning the steering wheel slightly to the right or left often makes it easier to turn the key from 0 to 1. Individual electrical equipment is ready for operation.

### **2 Ignition on**

All electrical equipment and accessories is ready for use.

### **3 Starting the engine**

 Vehicles with manual transmission: depress the clutch when starting the vehicle. A lockout prevents the engine from starting if the clutch is not depressed. ◀

## **Starting the engine**

- ▷ Engage the parking brake
- ▷ Ensure that the transmission selector is in "Neutral" ("Park" or "Neutral" if the vehicle is equipped with automatic transmission\*)
- ▷ Step on the clutch pedal when temperatures are low
- ▷ Start the engine. Do not press the accelerator pedal.

 Do not actuate the starter for too short a time, but do not turn it for more than approx. 20 seconds. Release the ignition key immediately when the engine starts.

Do not allow the engine to warm up by leaving it running while the vehicle remains stationary. Instead, drive off immediately at a moderate engine speed. ◀

 Do not run the engine in enclosed areas. The exhaust gases contain carbon monoxide, an odorless, colorless, yet highly toxic gas. Breathing the exhaust gases poses an extreme health risk, and can lead to unconsciousness and death.

Never leave the vehicle unattended with the engine running. An unattended vehicle with a running engine represents a potential safety hazard. ◀

## Starting the engine

If the engine does not start on the first attempt (if it is very hot or cold, for instance):

- ▷ Press the accelerator pedal halfway down while engaging the starter.

Cold start at extremely low temperatures, from approx. +5 °F (-15 °C) and at elevations above 3,300 feet (1,000 meters):

- ▷ On the first start attempt, engage the starter for a longer period (approx. 10 seconds)
- ▷ Press the accelerator pedal halfway down while engaging the starter.

## Switching off the engine

Turn the ignition key to position 1 or 0.



Do not remove the ignition key while the vehicle is still moving. If you did, the steering lock would engage when the steering wheel is turned. When you leave the vehicle, always remove the ignition key and engage the steering lock.

Vehicles with manual transmission:

Always engage the parking brake when parking on slopes and inclined surfaces, since placing the lever in 1st gear or reverse may not provide adequate resistance to rolling.

Vehicles with automatic transmission\*:  
Place the selector lever in "Park". ◀

## 72 Parking brake



### To engage

The lock engages automatically when you lift the lever, and the indicator lamp in the instrument cluster comes on when the ignition key is in position 2. Refer to page 21.

### To release

Pull up slightly on the lever, press the button and lower the lever.

The parking brake is designed primarily to prevent the vehicle from rolling when it is parked. It operates against the rear wheels.



If in rare instances, it should be necessary to engage the parking brake while the vehicle is in motion, do not pull the lever with excessive pres-

sure. Keep your thumb pressed against the release button while carefully pulling the lever up to apply moderate pressure.

Excessive pressure can lead to over-braking and loss of traction (fishtailing) at the rear axle.

The brake lamps do not come on when the parking brake is engaged.

Vehicles with manual transmission:

Always engage the parking brake when parking on slopes and inclined surfaces, since placing the lever in 1st gear or reverse may not provide adequate resistance to rolling.

Vehicles with automatic transmission\*: Place the selector lever in "Park". ◀

To avoid corrosion and one-sided braking, apply the parking brake lightly from time to time when coasting to a standstill (at a traffic signal, for instance), provided that it is safe to do so.





The shift lever's neutral plane (dot in the illustration) is located between 3rd and 4th gears.

When shifting from each gear into "Neutral", the shift lever returns automatically to this gear plane because of its spring loading.

## Reverse

Select reverse only when the vehicle is stationary. Press the shift lever to the left to overcome a resistance.

As you do this, the backup lamps will turn on automatically when the ignition key is in position 2.



Do not hold the vehicle in place on slopes by slipping or "riding" the clutch. Use the parking brake instead. A slipping clutch increases clutch wear. ◀

You have the option of driving with a normal automatic transmission or switching to manual.

When you move the selector lever from the "D" position to the left into the M/S range, the performance-oriented shift programs of the automatic transmission are engaged. As soon as you briefly touch the selector lever in the "+" or "-" direction, Steptronic changes the gear. The manual mode is engaged. Whenever you want to use automatic again, just shift the selector lever toward the right to position "D".

The automatic transmission with Steptronic is equipped with ATC (Adaptive Transmission Control). ATC reacts with precision to your individual driving style and the current driving conditions. To achieve this, different shift programs are engaged.

For additional details concerning ATC, please refer to the chapter describing "Advanced technology" on page 172.



### Selector lever positions

P R N D M/S + -

### Starting the engine

The engine can only be started in selector lever positions P ("Park") or N ("Neutral").

### Range selection

A detent prevents inadvertent shifts into certain selector lever positions. To disengage the detent, press the button on the front of the shift knob (arrow).

 While the vehicle is stationary and before shifting out of "Park" or "Neutral," depress the footbrake, otherwise the selector lever gets blocked (Shiftlock).

Hold the footbrake down until starting off. Otherwise the vehicle will "creep" when a drive position is engaged. ◀

 If you leave the vehicle with the engine running, move the selector lever to the "Park" or "Neutral" position and apply the parking brake. If you fail to do this, the vehicle could move. Do not leave the vehicle unattended with the engine running. An unattended vehicle with a running engine represents a potential safety hazard. ◀

### P Park

Select reverse only when the vehicle is stationary. The transmission locks to prevent the rear wheels from turning.

### R Reverse

Select reverse only when the vehicle is stationary.

### N Neutral

Select "Neutral" only if your journey is interrupted for a longer period.

## D Drive (automatic shift program)

This position is designed for driving under all normal operating conditions. All forward gears are available.

## "Kickdown"

In the "Kickdown" mode, you achieve maximum performance and the top speed in position "D".

To activate this mode, depress the accelerator pedal beyond the full-throttle position, going beyond the point of resistance.



## M/S Manual mode and Sport Program

Shifting from D into M/S activates the Sport Program. This is indicated by "SD" in the gear selection display. This position is recommended for a performance-oriented driving style.

With the first brief touch, the automatic transmission shifts from the Sport Program to the manual mode.

When you move the selector lever forward in the "+" direction, the transmission shifts up. When the lever is moved back in the "-" direction, the transmission shifts down. M1 to M5 appear in the gear indicator.

Upshifts or downshifts will only be carried out by the ATC at appropriate engine speeds and road speeds. If the engine speed is too high, for instance, a downshift will not be executed. The gear selected will appear briefly in the instrument cluster followed by the current gear.

 To accelerate quickly in the manual mode (to pass another vehicle), shift down manually or employ the "Kickdown" mode. ◀

Shifting from M/S to the selector lever positions P, R and N is possible only by going through D.

## 76 Automatic transmission with Steptronic\*

In the following situations, the Steptronic "thinks" for you in the manual mode:

- ▷ In order to prevent the engine from overrevving, the transmission shifts automatically to the next higher gear just before the RPM cutoff point
- ▷ If you do not do anything to intervene, it will automatically downshift at lower speeds
- ▷ In the "Kickdown" mode, the transmission shifts down to the lowest gear which is possible, depending on the engine speed
- ▷ Depending on the situation – when driving in adverse winter conditions, for example – you may also start out in 2nd or 3rd gear.



### Available displays

P R N D SD M1 M2 M3 M4 M5

### Electronic transmission control module



If the indicator lamp comes on, there is a malfunction in the transmission system.

Bring the vehicle to a stop. Move the transmission selector lever to "P". Set the parking brake and turn the engine off (ignition key to position 0).

Wait a few seconds, then start the engine.

If the indicator lamp goes out after a few seconds, normal transmission performance has been restored. You may continue to drive as usual. If the indicator lamp does not go out, you can put the selector lever in all positions. However, the vehicle will now only operate in 3rd and 4th gear.

If this happens, avoid extreme engine loads and consult the nearest BMW center.



Do not work in the engine compartment when a drive gear (forward or reverse) is engaged. If you do this, the vehicle could move. ◀

For towing and jump-starting the vehicle, refer to page [168](#)

## Turn signal indicator/Headlamp flasher



### To signal briefly

Press the lever up to but not beyond the detent. It then returns to the center position when released.

- 1 High beam  
(blue indicator lamp)
- 2 Headlamp flasher  
(blue indicator lamp)
- 3 Turn signal indicator (green indicator lamp accompanied by periodic clicking sound from the relay).

If the indicator lamp and the clicking from the relay are both faster than normal, one of the turn signal indicators has failed.

## Washer/Wiper system



- 0 Wipers retracted
- 1 Intermittent wipe or rain sensor\*
- 2 Normal wipe
- 3 Fast wipe
- 4 Brief wipe
- 5 Automatic windshield washer
- 6 Rotary dial for control of the wipe interval or the sensitivity of the rain sensor\*



### 1 Intermittent wipe or rain sensor\*

Intermittent wipe:

You can use rotary dial 6 to select from four wipe intervals.

In addition, the wipe interval automatically adapts to variations in road speed.

Rain sensor:

The rain sensor is located on the windshield, directly in front of the interior rearview mirror. When the rain sensor is activated, the windshield wiper is controlled automatically, depending on the degree of wetness of the windshield (in both snow and rain). You do not have to be concerned with switching the windshield wiper on or off or adjusting the wipe interval between intermittent and full wipe. Instead, you can concentrate

fully on the traffic conditions. This is especially important under adverse weather conditions.

To activate the rain sensor:

From ignition key position 1 and up, move the lever to position 1. The wipers travel once across the windshield, regardless of the weather.

You can leave the lever permanently in position 1. It is then only necessary to activate the rain sensor from ignition key position 1 and up. To do this,

- ▷ turn rotary dial 6 briefly or
- ▷ use the automatic windshield washer 5.

To adjust the sensitivity of the rain sensor:

Turn rotary dial 6.



Turn the rain sensor off when passing through an automatic car wash. Failure to do so could result in damage caused by undesired wiper activation. ◀

### 2 Normal wiper speed

When the vehicle is stationary, the wipers switch automatically to intermittent wipe (not on vehicles with rain sensor).

### 3 Fast wiper speed

When the vehicle is stationary, the wipers operate at normal speed (not on vehicles with rain sensor).

### 5 Automatic windshield washer

The system sprays washer fluid against the windshield and activates the wipers for a brief period.

If you only pull the lever briefly, the system sprays washer fluid onto the windshield without activating the wipers.

## Washer/Wiper system

### Headlamp washers\*

If the headlamps are on, they will also be cleaned every fifth time you activate the automatic windshield washer.

 Do not use the washers if there is any danger that the fluid will freeze on the windshield. If you do so, your vision could be obscured. Use an antifreeze agent. Refer to page [132](#). Do not use the washers when the reservoir is empty. If you do so, the washer pump could be damaged. ◀

### Windshield washer jets

The windshield washer jets are heated\* automatically when the ignition key is in position 2.

## Rear window defroster



### To deactivate

If the indicator lamp is still on, press the button.

### To activate

With the convertible top closed or with the hardtop\* mounted, press the button: as long as the indicator lamp remains on, the rear window defroster continues at high-output (rapid thaw).

After the indicator lamp goes out, the defroster continues operating at reduced power for a limited period before deactivating automatically.



The vehicle can store and automatically maintain any desired vehicle speed above approx. 20 mph (30 km/h) that you input.

### To activate the system

From ignition key position 2: Press button 1. The indicator lamp in the instrument cluster comes on. You can now use the cruise control.

### To store and maintain speed or to accelerate

Press button 3 briefly:

The system registers and maintains the current vehicle speed. Every time you briefly touch the button, the speed increases by 0.6 mph (1 km/h).

Press and hold button 3:

The vehicle accelerates without pressure on the accelerator pedal. When you release the button, the system registers and maintains the current speed.

 If, on a downhill gradient, the engine braking effect is not sufficient, the controlled speed can be exceeded. Speed can drop on uphill grades if the engine output is insufficient. ◀

### To decelerate

Press button 2 briefly:

If you are already driving with active cruise control, the speed is decreased by approx. 0.6 mph (1 km/h) every time you briefly press the button.

Press and hold button 2:

With the cruise control active, the system automatically reduces the throttle opening to slow the vehicle. When you release the button, the system registers and maintains the current speed.



# Cruise control

## To cancel the cruise control

When the system is activated, press button 1. The indicator lamp stays on. You can use the cruise control again as required.

In addition, cruise control is canceled automatically:

- ▷ If the brakes are applied
- ▷ If the clutch pedal is depressed or the automatic transmission\* selector lever is moved from "D" to "N"
- ▷ If you exceed or fall below the programmed speed for an extended period, for example by depressing the accelerator.

## To resume the stored setting

Press button 4:  
The vehicle accelerates to and maintains the last speed stored. When you turn the ignition key to position 0, the stored speed is deleted and the system is deactivated.

## To deactivate the system

When the cruise control has been canceled, press button 1 again. The indicator lamp goes out and the stored speed is deleted.



Do not use cruise control on twisting roads, when high traffic density prevents driving at a constant speed, when the road surface is slick (snow, rain, ice), or when the road surface is loose (rocks, sand). ◀



### 1 Odometer

You can activate the displays shown in the illustration with the ignition key in position 0 by pressing the button in the instrument cluster (arrow).

### 2 Trip odometer

To reset the trip odometer to zero, press the button (arrow) with the ignition key in position 1 and up.



Avoid engine speeds that fall within the gauge's red warning zone.

To protect the engine, the fuel supply is automatically interrupted in this zone; you will notice a loss of power.



Indicates current fuel consumption in mpg (in liters per 100 km on Canadian models). You can check your current driving style to see whether it is conducive to economy and minimum exhaust emissions.

When the vehicle is stationary, the needle goes to "Maximum" (zero on Canadian models).



When you switch on the ignition, the indicator lamp lights up briefly as an operation check.

Once the indicator lamp stays on continuously, there are still approx. 2.1 gallons (8 liters) of fuel left in the fuel tank.

For fuel tank capacity, refer to page 185. If the tilt of the vehicle varies (extended driving in mountainous areas, for example), there may be slight fluctuations of the needle.

 Please refuel early, since driving to the last drop of fuel can result in damage to the engine and/or catalytic converter. ◀



## Blue

The engine is still cold. Drive at moderate engine and vehicle speeds.

## Red

When you switch on the ignition, the warning lamp comes on briefly to confirm that the system is operational.

If the lamp comes on while operating the vehicle the engine is overheated. Shut off the engine immediately and allow it to cool down.

## Between the blue and red zones

Normal operating range. It is not unusual for the needle to go as far as the edge of the red zone in response to high outside temperatures or severe operating conditions.

Checking coolant level, refer to page 135.



## Remaining distance for service

The displays shown in the illustration appear for a few seconds when the ignition key is in position 1 or after the engine is started.

The next service due appears with the message OILSERVICE or INSPECTION, together with the remaining distance before scheduled service.

The computer bases its calculations of the remaining distance on the rate of fuel consumption in the period immediately preceding your data request.

A flashing display and a "-" in front of the number indicate that service interval has already been exceeded by the distance shown in the display. Please contact your BMW center for an appointment.

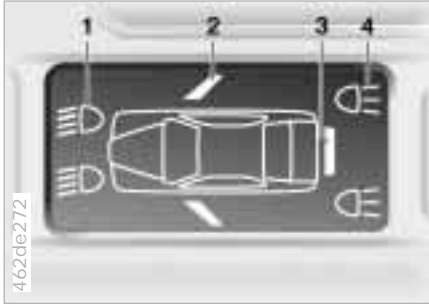

### Graphic display

The following alerts or status messages are displayed with icons from ignition key in position 2 and up until the defects are corrected.

- 1 Check low beams and high beams, as well as the parking lamps
- 2 Door open
- 3 Luggage compartment lid open
- 4 Check brake and tail lamps.

After a trip and when the driver's door is opened, an acoustical signal is given for "Lamps on" if the lamps have not been switched off.

## Clock

If you wish to have a permanent time display, you can make this adjustment in the car radio\* display (refer to the Radio Owner's Manual).

You can set the clock and the time display in the car radio\* as follows:



### Adjustments

From ignition key position 1:

To set ahead: turn the button to the right.

To set back: turn the button to the left. The adjustment speed will increase the longer you continue to hold the button.

To change the display mode: press the button briefly. Every time you press the button, the clock display alternates between the 12-hour or 24-hour mode.

In ignition key position 0: the time is displayed for a few seconds after you press the left button (refer to "Odometer" on page [82](#)).



## Mode selection

From ignition key position 1 and up, you can call up information from the onboard computer shown in the display of the instrument cluster using the button in the turn signal lever. By pressing the button briefly in the direction of the steering column, you can call up a new function for display.

The displays appear in the following order:

Time, outside temperature, average fuel consumption, cruising range, average vehicle speed.

Starting with ignition key position 1, the last active setting is displayed.



## Outside temperature

You can change the units of measurement (°C/°F) for the outside temperature display by pressing the right-hand reset button in the instrument cluster when the temperature display is active.

## Ice warning

If the outside temperature drops to approx. 37.5 °F (+3 °C), the onboard computer automatically switches to the outside temperature display. In addition, a signal sounds as a warning and the display flashes for a brief period.

The warning is repeated whenever the temperature climbs to at least 43 °F (+6 °C) following the last warning and then drops back to 37.5 °F (+3 °C).

 The ice warning does not alter the fact that surface ice can form at temperatures above +37.5 °F (+3 °C), on bridges or shaded road surfaces, for instance. ◀

## 86 Onboard computer\*



### Average fuel consumption

If you continue to press down on the button on the turn signal indicator lever, the average fuel consumption display will reset itself and will begin calculating average fuel consumption from that point onward.



### Range

The computer bases its calculations for the cruising range on the rate of fuel consumption in the period immediately preceding your data request.



### Average speed

If you continue to press down on the button on the turn signal indicator lever, the average speed display will reset itself and will begin calculating average speed from that point onward.

Any time spent when the vehicle is stationary and the engine is shut off is ignored for the calculation.

The PDC assists you when you are parking. A signal warns you of the real distance to an obstacle. To do this, four ultrasonic sensors in the rear bumper measure the distance to the nearest object. The range for the sensors at the two rear corners ends approx. 2 feet (60 cm) from the bumper. The range for the two center sensors is approx. 4.9 feet (1.50 meters) wide.

The system starts to operate automatically about one second after you select "Reverse" with the ignition key in position 2. PDC is deactivated when you shift back out of reverse.

### Acoustical signals

The distance to the nearest object is indicated by a tone sounding at various intervals. As the distance between vehicle and object decreases, the intervals between the tones become shorter. A continuous tone indicates the presence of an object less than approx. 1 foot (30 cm) away.

The warning signal is canceled after approx. three seconds if the distance to the obstacle remains constant during this time (if you are moving parallel to a wall, for instance).

System malfunctions are indicated by a continuous high-pitched tone when the system is activated the first time. Please refer the problem to your BMW center.



The PDC does not remove the driver's personal responsibility for evaluating the distance between the vehicle and any obstacles. Even when sensors are involved, there is a blind spot in which objects cannot be detected. This applies especially in those cases where the system approaches the physical limits of ultrasonic measurement, as occurs with tow bars and trailer couplings, and in the vicinity of thin and painted objects. Certain sources of sound, such as a loud radio, could drown out the PDC signal tone. ◀



Keep the sensors clean and free of ice or snow in order to ensure that they continue to operate effectively. Do not apply high pressure spray to the sensors for a prolonged period of time. Maintain a distance of more than 4 inches (10 cm). ◀



### The concept

DSC helps maintain vehicle stability, even in critical driving situations.

The system optimizes vehicle stability during acceleration and when starting from a full stop, as well as optimizing traction. In addition, the system recognizes unstable vehicle conditions (understeering or oversteering, for example) and helps hold the vehicle on a sure course by intervening via the engine and by braking intervention at the individual wheels.

The system activates automatically each time you start the engine.

### Indicator lamp



The indicator lamp in the instrument cluster goes out shortly after you switch on the ignition.

Refer to pages [21](#) and [22](#).

Indicator lamp flashes:

The system is active and governs drive force and braking force.

If the indicator lamp fails to go out after the engine is started, or if it comes on during normal driving and stays on:

There is a system malfunction or the system was deactivated with the button. You can continue to drive the vehicle normally, but without DSC. Please consult your BMW center for repairs.

### To deactivate the system

Press the button, the indicator lamp comes on.

The illustration depicts the arrangement of the buttons if the vehicle is fully equipped. This may vary, depending on the equipment actually installed.

When the DSC is deactivated, you are operating the vehicle in the conventional drive mode.

In the following exceptional circumstances, it may be effective to deactivate the DSC for a short period:

- ▷ When rocking the vehicle or starting off in deep snow or on loose surfaces
  - ▷ or when driving with snow chains.
- Refer also to page [118](#).

### To reactivate the system

Press the button again; the indicator lamp goes out.



The laws of physics cannot be repealed, even with DSC. Any consequences arising from traction loss due to excessive vehicle speed remain the responsibility of the driver. For this reason, do not take risks by using the additional safety margin provided by the system as an excuse. ◀

For additional details concerning DSC, please refer to the chapter describing "Advanced technology" on page [173](#).



## Tire Pressure Control (RDC)\*

### The concept

RDC monitors the tire pressure at all four wheels – even while you are driving. The system provides an alert whenever the inflation pressure drops significantly below the specified pressure in one or more tires.

In order for the system to "learn" correct tire inflation pressure, check the pressure in all the tires, compare your pressures with those in the tire inflation tables (page 28), and make corrections as necessary. Then activate the system.



This indicator lamp in the instrument cluster informs you whenever the tire pressure is not normal.



### Activate the system

- 1 Turn the ignition key to position 2 (do not start the engine)
- 2 Press the button long enough for the indicator lamp in the instrument cluster to light up yellow for a few seconds
- 3 After you have driven a few minutes, RDC imports the current tire inflation pressures as the nominal values to be monitored.

You will only have to repeat this procedure following a correction of the tire inflation pressure. Otherwise, the RDC functions automatically when the ignition key is in position 2, and thus operates whenever the vehicle is driven.

### Loss of tire pressure

If the inflation pressure has dropped significantly over a long period of time (which is normal for any tire), the indicator lamp will come on with a yellow lamp.

This alerts you that you should have the tires inflated to the specified pressures as soon as possible.



If you are prompted to check the tire pressure shortly after a correction has been made, this indicates that the corrected values were not accurate. Please check the inflation pressure again and make corrections according to the inflation pressure table. Then activate the system once again. ◀

### **Flat tire**

If there is a tire failure with loss of pressure, the indicator lamp comes on with a red lamp. In addition, an acoustic signal goes off.

If this occurs, reduce vehicle speed immediately and stop the vehicle. Avoid hard brake applications. Do not oversteer. Replace the wheel and flat tire.

 The space-saver spare tire is provided for temporary use only in the case of a tire failure. It does not have RDC electronics and is not monitored. ◀



RDC cannot inform you of sudden and severe tire damage caused by external influences. ◀



Have the tires changed by your BMW center. Your BMW center is familiar with, and has the special tools necessary, for working on the RDC. ◀

### **System interference**

The RDC may encounter interference from outside equipment or devices which use the same radio frequency.

The indicator lamp will come on with a yellow lamp during the malfunction.

The indicator lamp also comes on

- ▷ in the event of a system fault
- ▷ if a wheel is mounted without RDC electronics
- ▷ or if additional wheels using RDC electronics are transported.

Please contact your BMW center for additional information.



### Parking lamps



With the switch in this position, the front, rear and side vehicle lighting comes on. For lighting on one side for parking, refer to page [92](#).

### Low beams



When the ignition is switched off and the low beams are on, only the parking lamps will remain on.



"Follow-Me-Home" lamps:

If you actuate the headlamp flasher after you have parked the vehicle and shut off the engine, the low beams will remain on for a brief period. You may also have this function deactivated if you wish. ◀

### "LAMPS ON" warning

When you open the driver's door after turning the ignition key to position 0, an acoustic signal will go off for a few seconds to remind you that the headlamps have not been switched off.

### Daytime running lamps\*

If you desire, the lamp switch can be left in the second position. When the ignition is switched off, the external lighting is also switched off.



Turn the rotary dial to adjust the illumination intensity.



- 1 High beam  
(blue indicator lamp)
- 2 Headlamp flasher  
(blue indicator lamp)
- 3 Parking lamps

### Parking lamp, left or right

With the ignition key in position 0, engage the lever in the appropriate turnsignal position.



### Front fog lamps



A green indicator lamp appears in the instrument cluster to indicate that the front fog lamps are on.



The interior lamps are controlled automatically.

### To switch the interior lamps on and off manually

Press the button briefly.

If you want the interior lamps to remain off all the time, press and hold the button for approximately 3 seconds.

To revert to normal operation, press the button briefly.

### Footwell lamps

The footwell lamps operate in the same way as the interior lamps.

## Reading lamps

Reading lamps are in the front next to the interior lamp. They can be switched on and off with the switch adjacent to each lamp.



In order to prevent draining the battery, all of the lamps in the vehicle are switched off automatically approx. 15 minutes after the ignition key has been turned to 0. ◀

## 94 Automatic climate control

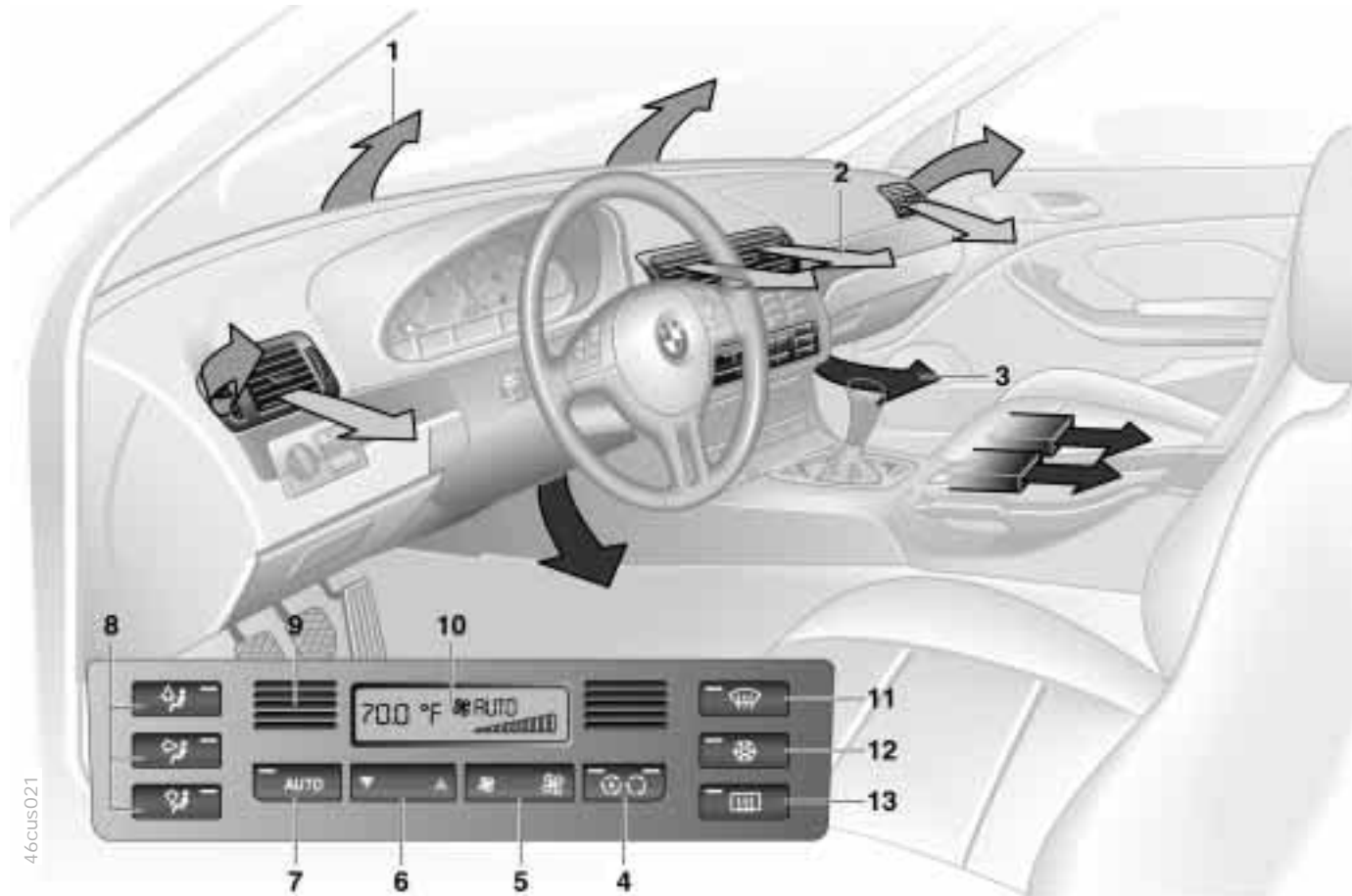

# Automatic climate control

- 1 Air onto the windshield and the side windows
- 2 Air flow toward the upper body  
The side rotary dials provide infinitely variable regulation of the air supply, while the levers change the air flow direction. The center rotary dial controls the temperature of the air as it flows out, refer to page [98](#)
- 3 Front footwell ventilation  
There are corresponding air vents in the rear footwell as well
- 4 Recirculated air mode/Automatic recirculated air control (AUC) [97](#)
- 5 Air supply [97](#)
- 6 Temperature [96](#)
- 7 Automatic air distribution [96](#)
- 8 Individual air distribution [96](#)
- 9 Air grill for interior temperature sensor – please keep clear and unobstructed
- 10 Display for temperature and air supply [96](#)
- 11 Defrost the windshield and side windows [97](#)
- 12 Air conditioner [97](#)
- 13 Rear window defroster [79](#), [98](#)

### Tips for pleasant driving

Use the automatic system (switch on AUTO button 7). Select an interior temperature that is comfortable for you – we recommend 72 °F (+22 °C). When the outside temperature is above 41 °F (+5 °C), you can also use the air conditioner 12. This will dry the air as well as preventing condensation on the window surfaces – if there are passengers with damp clothing, for example. Set the outlets 2 so that the air flows past you and is not directed straight at you. Set the rotary dial between the air outlets 2 for the upper body to a medium position, since air that is somewhat cooler promotes driving without fatigue. Detailed setting options are described for you in the following section.



When you unlock the vehicle using your personalized remote control key, your vehicle is set up so that it will retrieve and initiate your customized setting for the automatic climate control. ◀

### Automatic air distribution



The AUTO program assumes the adjustment of the air distribution and the air supply for you and adapts the temperature to external influences (summer, winter) to meet preferences you can specify. This program maintains a comfortable in-car climate regardless of the season. Select an interior temperature that is comfortable for you – we recommend 72 °F (+22 °C). The temperature selected and AUTO for the air flow appear in the display 10 (refer to the overview on page 94). Open the air outlets for the upper body area. Switch on the air conditioner in warm weather. The maximum cooling capacity is achieved when you set rotary dial 3 (refer to page 98) to cold.

### Individual air distribution

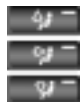

You can cancel the AUTO program by selecting specific distribution patterns to suit your own individual requirements. You can direct air to flow onto the windows toward the upper body , and into the footwell .

### Temperature



The figures in the display provide a general indication of interior temperature. We recommend 72 °F (+22 °C) as a comfortable setting, whether the air conditioner is operating or not. When you start the vehicle, the system ensures that the selected temperature is reached as quickly as possible. The system then maintains this temperature, regardless of the season. Set rotary dial 3 (refer to "Draft-free ventilation" on page 98) to a medium setting, since air that is somewhat cooler promotes driving without fatigue. You can use this setting for mixing air to make minor comfort modifications.



You can set uncontrolled heater output up to 90 °F (+32 °C). At 60 °F (+16 °C), full cooling output is available from an activated air conditioner. ◀



# Automatic climate control

## Air supply

 By pressing the left or right half of the button, you can vary the air supply. By doing this, you switch off the automatic control for the air supply. Nevertheless, the automatic air distribution remains unchanged.

When you set the lowest blower speed by pressing the left half of the button, all of the displays are canceled: the blower, heater and air conditioner are switched off, and the air supply stops. You can reactivate the system by pressing any button of the automatic climate control.

## Defrost the windshield and side windows

 This program quickly removes ice and condensation from the windshield and side windows.

## Air conditioner

 The air is cooled and dehumidified and – depending on the temperature setting – rewarmed when the air conditioner system is switched on. Depending on the weather, the windshield may fog over briefly when the engine is started.

Use the button to switch the air conditioner off when outside air temperatures are below approx. 41 °F (+5 °C). This will help to prevent the windows from fogging over.

If the windows fog over after switching the air conditioner off, switch it back on.

 Condensation forms in the air conditioner system during operation, which then exits under the vehicle. Traces of condensed water of this kind are thus normal. ◀

## Automatic recirculated air control (AUC)

 If there are unpleasant odors or pollutants in the outside air, you can temporarily block the air flow from the outside. The system then recirculates the air already within the vehicle. By repeated actuation of the button, you can select three different operating modes.

- ▷ Indicator lamps off: fresh air flows into the vehicle
- ▷ Left-hand indicator lamp on – AUC mode: the system detects pollutants in the outside air and responds by deactivating the outside air flow as required. The system then recirculates the air already within the vehicle. Depending on air quality requirements, the system automatically switches between outside air supply and recirculation of the air already within the vehicle
- ▷ Right-hand indicator lamp on: the flow of outside air is permanently blocked. The system recirculates the air already within the vehicle.

 If the windows fog over in the recirculated air mode, switch this mode off and increase the air supply as required. ◀

### Rear window defroster



When the rear window defroster is activated, the indicator lamp comes on. The rear window defroster switches off automatically. Refer to page 79.

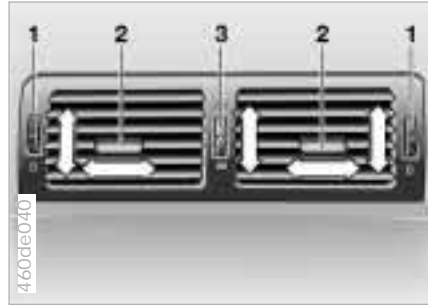

### Draft-free ventilation

You can adjust the blower controls for the upper body area to select the optimum airflow rates and directions for your personal comfort:

Use rotary dials 1 to open and close the air outlets through an infinitely-variable range. You can adjust the direction of the airflow with rotary dial 2.

Set the air outlets so that the air flows past you and is not directed straight at you.

Rotary dial 3 allows you to mix the the air from the outlets for your upper body by warming or cooling the air as desired.

### Activated charcoal filter

An activated charcoal filter has been installed in your BMW to filter the outside air and to catch any incoming dust and pollen. It provides additional protection by filtering gaseous pollutants from the outside air. Your BMW center can replace the combined filter as a standard part of your scheduled maintenance. A substantial reduction in air flow indicates that the filter needs to be replaced early.



The seat cushion and backrest can be heated when the ignition key is in position 2.

You can call up different heating modes by repeatedly pressing the button.

When the three indicator lamps are illuminated, the highest heating mode is activated. One lamp indicates the lowest heating mode. The temperature is regulated with a thermostat in each mode.

You can also switch the higher heating modes off directly:  
Press the button and hold it slightly longer.



### To open

Pull the handle. The lamp comes on.

### Closing

Fold the cover up.

### To lock

Lock with one of the master keys.  
A master key can also be used for unlocking.



If you turn over only your door and ignition keys for valet parking (refer to page 32), for example, access to the glove compartment and the luggage compartment is not possible. ◀



To prevent injury in the event of a crash, close the glove compartment immediately after use. ◀

### Rechargeable flashlight

The flashlight is located on the left-hand side of the glove compartment. It features integral overload protection so it can be left in its holder continuously.



Be sure that the flashlight is switched off when it is inserted into its holder. Failure to do so could lead to overcharging and damage. ◀

**The concept**

The BMW Universal Transmitter replaces up to three hand-held transmitters for different devices such as garage-door openers, alarm systems, or door-locking systems. The BMW Universal Transmitter recognizes and "learns" the transmitted signal of each of the original hand-held transmitters.

The signal of an original hand-held transmitter can be programmed on one of the three channel keys. Following that, each of the devices can be actuated with the appropriately programmed channel key. The indicator lamp flashes to confirm transmission of the signal.

If the vehicle is sold, the memory of the channel keys should be cleared as described on page 102.

 During programming and before every remote actuation of a programmed device by the BMW Universal Transmitter, check to be sure that there are no persons, animals or objects within the actuation range of the device in order to prevent possible injuries or damage. Also, comply with the safety precautions of the original hand-held transmitter. ◀



To Canadian residents:  
During programming, your hand-held transmitter may automatically stop transmitting after two seconds. This may not be long enough to program the BMW Universal Transmitter. If you are programming from one of these hand-held transmitters, the Universal Transmitter's light may begin to flash in a series of double-blinks. If this occurs, continue to hold the button of the Universal Transmitter while you reactivate your hand-held transmitter. You may have to repeat this function several times while programming. ◀



Before programming, read the "User information" section on page 102. ◀

**Original hand-held transmitter**

If this symbol is present on the packaging or in the instructions of the original hand-held transmitter, it may be assumed that this hand-held transmitter is compatible with the BMW Universal Transmitter.

**Checking for the conversion code**

To determine whether the original hand-held transmitter has a conversion-code system, you may either read the instructions for the original hand-held transmitter or program a channel key as described on the next page (left-hand column under "Programming").

Then press and hold the programmed channel key of the BMW Universal Transmitter. If the indicator lamp of the BMW Universal Transmitter flashes for two seconds and then stays on steadily, the original hand-held transmitter is equipped with a conversion-code system. Using the conversion-code system, program the channel keys as described on the next page (right-hand column under "Programming a hand-held transmitter using conversion code").



If you have additional questions, please consult your BMW center or call 1-800-355-3515. You can also visit this website: [www.bmwusa.com](http://www.bmwusa.com). ◀

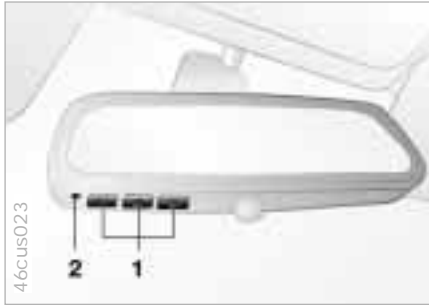

## Programming

- 1 Channel keys
- 2 Indicator lamp

 Read and comply with the safety precautions on the previous page. ◀

- 1 Turn the ignition key to position 2
- 2 To initialize: press and hold both outside keys 1 until the indicator lamp 2 flashes, and then release them. The three channel keys are cleared

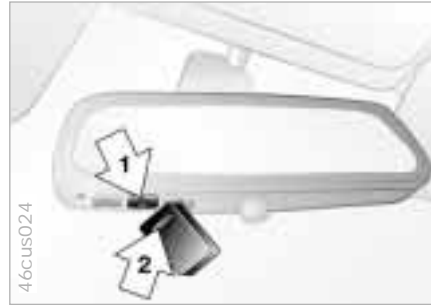

- 3 Hold the original hand-held transmitter to the receiver embedded in the mirror, e.g. right near the buttons, no further than 2 inches away (5 cm)
- 4 Press the transmission key of the original hand-held transmitter (arrow 2) and the desired channel key of the Integrated Universal Remote Control (arrow 1) simultaneously. Release both keys as soon as the indicator lamp flashes rapidly
- 5 To program other original hand-held transmitters, repeat steps 3 and 4.

The corresponding channel key is now programmed using the signal from the original hand-held transmitter.

## Programming a hand-held transmitter with conversion code

 Read and comply with the safety precautions on previous page. ◀

When programming the BMW Universal Transmitter, consult the instructions for the specific device. For using the BMW Universal Transmitter with a conversion-code system, note the following supplemental programming instructions:

 A second person facilitates programming of the BMW Universal Transmitter. ◀

- 1 Program the BMW Universal Transmitter as described previously under "Programming"
- 2 Press and hold the programming key on the receiver of the device for approximately two seconds until the programming lamp on the device comes on
- 3 Press the desired channel key of the BMW Universal Transmitter three times.

 If you have additional questions, please consult your BMW center. ◀

### Clearing the channel keys

 Read and comply with the safety precautions on page 100. ◀

The memory of individual channel keys cannot be deleted. However, the three channel keys can be cleared together as follows:

- ▷ Press and hold both outside keys of the BMW Universal Transmitter until the indicator lamp flashes, and then release them.

All of the channel keys are cleared.

### User information

Do not use this BMW Universal Transmitter with any garage door opener that lacks safety "stop" and "reverse" features as required by federal safety standards (this includes any garage door opener model manufactured before April 1, 1982).

This device complies with Section 15 of the FCC Rules. Operation is subject to the following two conditions: as defined in the regulations, this device must not emit harmful interference, and must be shielded against interference from external sources to prevent unauthorized or inadvertent activation.

### Storage compartments



Open the storage compartment in the front center armrest: press the button (arrow) and lift upward.

You will find additional storage compartments in the doors and in the center console above the ashtray. Storage nets are located on the back of the front seats.

## Storage compartments



### Cup holder, coin box

A coin box and two cup holders are provided in the center console.

## Cellular phone\*



### Hands-free system

In vehicles with a telephone preparation\* or a communications package\*, the cover for the hands-free microphone is located above the rearview mirror on the driver side.

For further information on the cellular phone, refer to the separate Owner's Manual.

## Ashtray front



### To open

Press briefly in direction indicated by arrow.

To extinguish a cigarette, tap off the ash and gently press the tip into the funnel.

**To empty**

Press the edge of the lid (arrow): you can now pull the ashtray upward for removal.



Press the lighter in. Remove the lighter as soon as it retracts.

 Hold or touch the hot cigarette lighter by the knob only. Holding or touching it in other areas could result in burns. The cigarette lighter remains operational when the ignition key has been removed. For this reason, children should never be left in the vehicle unattended. ◀

**Cigarette lighter socket**

This socket can be used for connecting a flashlight, car vacuum cleaner, or other appliances up to approx. 200 watts at 12 volts. Avoid damaging the socket due to inserting plugs of different shapes or sizes.

**To open**

Push the cover open.

**To empty**

Press on the edge of the raised cover in the opening direction (arrow). You can now pull the ashtray upward for removal.



## Ski bag\*

The ski bag allows the safe and clean transport of up to three pairs of skis or two snowboards.

The length of the ski bag and the additional space provided in the luggage compartment make it possible to carry skis with a length of up to 6.8 feet (2.10 meters). Because of the tapered shape of the bag, the ski bag can only accommodate two pairs of skis that are 6.8 feet long (2.10 meters).

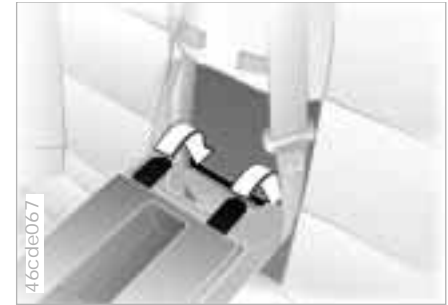

### Loading

- 1 Release the safety belts from their holders
- 2 Press down on the button (arrow) and remove the fill piece by pulling it forward
- 3 Extend the ski bag between the front seats. The zipper provides convenient access to stored items. It may be opened to allow the ski bag to dry

 To re-attach the fill piece, guide the tabs into the strip of molding and snap the fill piece back into place. The safety belts can then be re-secured into their holders. ◀



- 4 Press the button in the luggage compartment (arrow)
- 5 Use the magnetic retainer to fasten the cover panel to the back wall.

### Securing the load

 Secure the skis or other objects in the bag by tightening down the retaining strap at the buckle. ◀

Please ensure that the skis are clean before loading them into the bag. Take care to avoid damage from sharp edges.

## Cargo loading

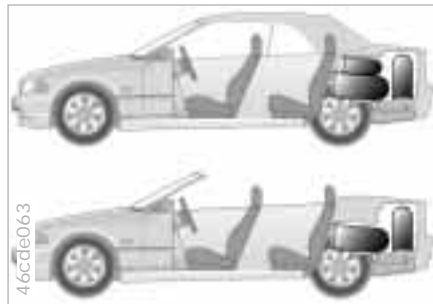

### Stowing cargo

If you are transporting a load in your BMW:

- ▷ Load heavy cargo as far forward as possible – directly behind the backrests or the luggage compartment partition – and as low as possible
- ▷ Cover sharp edges and corners.

 To enlarge the luggage compartment when the convertible top is closed, refer to page 41.

We recommend that you always fold the convertible top compartment panel down as soon as you have unloaded the luggage compartment. That way you will always be sure of being able to operate the convertible top at any time. Reverse the process by flipping the convertible top compartment panel up before stowing any cargo in the luggage compartment, which will (also) prevent any damage to the convertible top compartment or the cargo. ◀

## Cargo loading

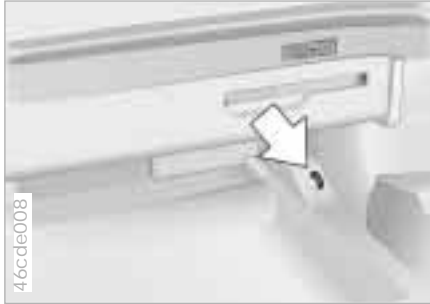

### Securing the load

- ▷ For small, light items, use the rubber-lined non-skid side of the floor mat or secure with a luggage compartment net\* or elastic straps (refer to page 40)
- ▷ For large, heavy pieces, see your BMW center for load-securing devices\*. Lashing eyes (arrow) are provided at the corners of the luggage compartment for attaching these load-securing devices
- ▷ Comply with the information enclosed with the load-securing devices.



Always position and secure the load correctly. If you do not, it can endanger the passengers during braking or evasive maneuvers.

Do not exceed the permissible gross vehicle weight and the permissible axle loads (refer to page 184). If you do, safe operation of the vehicle is no longer ensured, and you are in violation of the law.

Do not carry hard or heavy objects unsecured in the passenger compartment. If you do so, they may be projected through the air during braking and evasive maneuvers, thus endangering vehicle occupants. ◀



### **Mounting points**

Access to the mounting points:

To open the covers (arrow), please use the tool included with the luggage rack system.

A special roof-rack system is available for your BMW as an optional extra. Please observe the precautions included with the installation instructions.

Because roof racks raise the center of gravity of the vehicle when loaded, they exercise a major effect on its handling and steering response.

You should therefore always remember not to exceed the approved roof weight, the approved gross vehicle weight or the axle weights when loading the rack. You will find the specifications under "Technical Data" on page [184](#).

Make sure that the load is not too heavy, and attempt to distribute it evenly. Always load the heaviest pieces first (on the bottom). Make sure nothing projects into the luggage compartment lid's opening and closing path.

Secure the roof luggage correctly and securely to prevent it from shifting or being lost during driving (danger to following traffic).

Drive smoothly and avoid sudden acceleration or braking. Do not corner at high speeds.

The roof load increases aerodynamic resistance, resulting in increased fuel consumption and additional stresses on the vehicle body.





**Special operating instructions:**

Break-in procedures 112  
 Driving notes 113  
 Catalytic converter 113  
 Antilock Brake System (ABS) 114  
 Disc brakes 116  
 Brake system 117  
 Winter operation 118  
 Power steering 120  
 Cellular phone 120  
 Radio reception 120  
 Hardtop 121

**Wheels and tires:**

Tire inflation pressure 123  
 Tire condition 123  
 Tire replacement 124  
 Tire rotation 125  
 Wheel and tire combinations 126  
 Winter tires 127  
 Snow chains 127  
 Approved wheel and tire specifications 128

**Under the hood:**

Hood 129  
 Engine compartment 130  
 Washer fluids 132  
 Washer nozzles 132  
 Engine oil 133  
 Coolant 135  
 Brake fluid 136  
 Vehicle Identification Number 137

**Care and maintenance:**

The BMW Maintenance System 138  
 Caring for your vehicle 139  
 Cleaning and caring for your convertible top 144  
 Airbags 146  
 Vehicle storage 147

**Laws and regulations:**

Technical modifications to the vehicle 148  
 OBD interface socket 149

**Overview****Controls and features****Operation, care and maintenance****Owner service procedures****Advanced technology****Technical data****Index**

To ensure that your vehicle provides maximum economy throughout a long service life, we request that you comply with the following recommendations.

### **Engine and differential**

Up to 1,200 miles (2,000 km):

Drive at varying engine and road speeds, but do not exceed 4,500 rpm or 100 mph (160 km/h) during this time.

Obey your local and state maximum speed limits.

Refrain from using full throttle and avoid pressing the accelerator beyond the "kickdown" point.

After you have driven 1,200 miles (2,000 km), you can gradually increase the engine and road speed.

You should also comply with these break-in procedures if the engine or differential is replaced at a later point.

### **Tires**

Due to technical factors associated with their manufacture, tires do not achieve their full traction potential until an initial break-in period has elapsed. Thus, drive with extra care during the initial 200 miles (300 km).

Obey your local and state maximum speed limits.



When the vehicle is operated on wet or slushy roads, a wedge of water may form between the tire and the road surface. This phenomenon is referred to as aquaplaning, or hydroplaning, and can lead to partial or complete loss of traction, vehicle control and braking effectiveness. Reduce your speed on wet roads. ◀

### **Brake system**

Brake pads and rotors do not achieve their optimum wear and surface-contact patterns until you have driven approx. 300 miles (500 km).

To break in the separate parking brake drums, apply the parking brake lightly when coasting to a standstill (at a traffic signal, for instance), provided that traffic conditions allow you to do so.

To avoid corrosion, repeat this procedure from time to time.



The brake lamps do not come on when the parking brake is applied. Vacuum for the brake system servo unit on your BMW is available only when the engine is running. When you move the vehicle with the engine shut off – when towing, for example – substantially higher levels of pedal force will be required to brake the vehicle. ◀



## Driving notes



### Brakes:

Do not drive with your foot resting on the brake pedal. Even light but consistent pedal pressure can lead to high temperatures, brake wear, and possibly to brake failure.

### Aquaplaning:

When driving on wet or slushy roads, reduce vehicle speed. If you do not, a wedge of water may form between the tires and the road surface. This phenomenon is referred to as aquaplaning or hydroplaning. It is characterized by a partial or complete loss of contact between the tires and the road surface. The ultimate results are loss of steering and braking control.

### Driving through water:

Do not drive through water over the road if it is deeper than 1 ft (30 cm), and then only at walking speed, otherwise the engine, electrical system and transmission could be damaged.

Clothes hooks (when hardtop\* is mounted):

When suspending clothing from the hooks, ensure that they will not obstruct the driver's vision. Do not hang heavy objects on the hooks. If you do, they could cause personal injury during braking or evasive maneuvers. ◀

## Catalytic converter

The catalytic converter reduces harmful exhaust emissions. It is designed for use with unleaded fuel only. Even minute quantities of lead would be enough to permanently damage both the catalytic converter and the system oxygen sensor.

To ensure efficient, trouble-free engine operation and to avoid potential damage:

- ▷ Be sure to comply with the scheduled maintenance requirements
- ▷ Fill the fuel tank well before it is empty
- ▷ Tow-start only when the engine is cold. If you attempt to tow-start with a warm engine, unburned residual fuel in the catalytic converter could ignite and cause damage. It is better to jump-start the vehicle with outside assistance
- ▷ Avoid other situations in which the fuel is not burned, or burns incompletely, such as engaging the starter frequently or for extended periods, or repeated start attempts in which the engine does not start (stopping and restarting an engine which is running properly does not present a problem). Never allow the engine to run with any of the spark plug cables disconnected.



Be sure to observe the instructions above to prevent unburned fuel from reaching the catalytic converter, otherwise, the catalytic converter could overheat and be damaged. High temperatures occur in every vehicle equipped with a catalytic converter. Heat shields are installed adjacent to some sections of the exhaust system. Never remove these shields; do not apply undercoating to their surfaces. When driving, standing at idle, and parking the vehicle, take extra care to avoid contact between the exhaust system and flammable materials (grass, hay, leaves, etc.). Such contact could lead to a fire, resulting in serious personal injury and property damage. ◀

### **The concept**

ABS enhances active driving safety by helping to prevent the wheels from locking while braking. This is because locked wheels are dangerous. When the front wheels slide, the driver loses steering control over the vehicle.

Traction loss at the rear wheels can cause the rear end to break into an uncontrolled skid.

ABS is designed to meet two essential requirements during every brake application:

- ▷ To help provide vehicle stability
- ▷ To help maintain steering control and maneuverability – on all types of road surfaces (asphalt, concrete, mud, wet road surfaces, snow, ice).

The system can achieve the shortest braking distances possible under most conditions (on straight aways and in curves, on asphalt, ice, wet road surfaces, etc.).

### **Braking with ABS**

The system is operative once the vehicle exceeds a speed of approx. 6 mph (10 km/h). It is deactivated once again below approx. 4 mph (6 km/h). This means that the wheels can lock in the final phase of a panic stop – a factor of no significance in actual use.

If you are in a situation that requires full braking, you will exploit the full benefits of the ABS system if you apply maximum brake pressure ("panic stop"). Since the vehicle maintains steering responsiveness, you can nevertheless avoid possible obstacles with a minimum of steering effort.

The ABS closed-loop control circuit cycles in fractions of a second. A pulsation at the brake pedal, together with the sounds associated with the hydraulic controls, tells you that the brake system is within its maximum limit range, and reminds you that you should adapt road speed to the road conditions.

On road surfaces that have a loose surface layer on a firm base with good traction (on gravel or snow, for example), or when snow chains are mounted, braking distances may be longer than with locked wheels.

However, ABS continues to provide enhanced vehicle stability and steering response under these conditions.

### **Information for your safety**

Not even ABS can suspend the laws of physics. ABS cannot prevent the consequences of brake applications with inadequate clearances for safety between vehicles, when exceeding the speed limit in curves, or the risks involved when aquaplaning occurs. Responsibility for these types of situations remains in the hands (and at the feet) of the driver. You should never allow the added safety of ABS to lull you into a false sense of security, or mislead you into taking increased risks that could affect your own safety and that of others.



Do not make any modifications to the ABS system.

Service procedures on ABS are to be performed by authorized technicians only. ◀

# Antilock Brake System (ABS)

## Antilock Brake System (ABS)/ Cornering Brake Control (CBC)

CBC is an advanced engineering design of the ABS. When braking while cornering at high speed or braking during high lateral acceleration, or when braking during a lane change, vehicle stability is improved and steering response is enhanced.

### In the event of a malfunction



If the ABS warning lamp in the instrument cluster lights up, refer to page 22. The brake system then reverts to conventional operation as on vehicles without ABS. However, have the brake system checked by your BMW center as soon as possible, to prevent undetected defects and cumulative faults from adversely affecting the brake system.



ABS warning lamp for Canadian models.



If the brake warning lamp comes on together with the indicator lamps for ABS and DSC – refer to page 21 – the entire ABS, CBC and DSC control system has failed. Continue driving cautiously and defensively. Avoid full brake applications.

This could cause the vehicle to lose stability and you might no longer be able to control it.

Have the system checked as soon as possible by your BMW center.



Indicator and warning lamps CBC, ABS and DSC for Canadian models.

Disc brakes furnish optimum deceleration and braking control and greater fade resistance under heavy use.

When the vehicle is driven only occasionally, during extended periods when the vehicle is not used at all, and in operating conditions where brake applications are less frequent, there is an increased tendency for corrosion of the rotors and accumulation of contamination on the brake pads. This occurs because the minimal pressure that must be exerted by the pads to clean the rotors by brake applications is not reached.

If the brake rotors are corroded, they will tend to respond to braking with a pulsating effect that even extended brake applications will fail to cure.

 For your own safety: use only brake pads that BMW has approved for your particular vehicle model. BMW cannot evaluate non-approved brake pads to determine if they are suited for use, and therefore cannot ensure the operating safety of the vehicle if they are installed. ◀

### Driving notes

When driving in wet conditions and in heavy rain, it is advisable to apply light pressure to the brake pedal every few miles or kilometers. Watch traffic conditions to ensure that this maneuver does not endanger other drivers. The heat which is generated by the brake applications helps to dry the brake pads and rotors.

Maximum braking force is obtained while the wheels continue to rotate, but rather when they are still barely turning immediately prior to locking. ABS maintains this state automatically. If the ABS fails, you should revert to the staggered braking technique described on page 119.

Extended or steep mountain descents do not necessarily lead to reduced braking efficiency if you drive downhill with the transmission in a gear that allows minimal brake applications (or, with automatic transmission\*, in an appropriate lower gear).

You can further increase the engine's braking effect by selecting a lower gear, downshifting as far as first gear or placing the selector lever in position 1.

If engine braking should prove to be inadequate, you should still avoid extended, continuous braking. Instead of maintaining low to moderate pressure over an extended period of time, you should decelerate by applying more substantial pressure to the brake pedal (watch for following traffic), releasing the pedal, and then repeating the application (staggered braking). The cooling phases between active braking intervals prevent the brakes from overheating, thus ensuring that full braking capacity remains available at all times.

 Do not coast with the clutch depressed or with the shift lever or selector lever in "Neutral". Do not drive with the engine shut off. The engine provides no braking effect when the clutch is depressed or the transmission is in "Neutral", and there is no power assist for braking or steering when the engine is not running. Do not allow floor mats, carpets or any other objects to protrude into the area around the brake pedal, the clutch or the accelerator, which could obstruct their freedom of movement. ◀

# Brake system

## Brake fluid level



If the warning lamp for the brake system comes on with the parking brake released:

The brake fluid level is too low in the reservoir (refer to page 136).

If the brake fluid level is too low and brake pedal travel has become noticeably longer, there may be a defect in one of the hydraulic circuits of the brake system.



Warning lamps or the brake system for Canadian models.



Proceed to the nearest BMW center. Increased brake application pressure may be necessary under these conditions, and brake pedal travel may be significantly longer. Please remember to adapt your driving style accordingly. ◀

## Brake linings



If the warning lamp for the brake pads lights up:

The brake pads have reached their minimum pad thickness. Proceed to the nearest BMW center as soon as possible to have the pads replaced.



For your own safety: use only BMW approved brake pads for your particular vehicle model. BMW cannot evaluate non-approved brake pads to determine if they are suited for use, and therefore cannot ensure the operating safety of the vehicle if they are installed. ◀

Winter is often accompanied by rapid changes in weather, requiring not only a different driving style, but also certain preparations to the vehicle itself to ensure that your vehicle operates safely and trouble free throughout the winter months.

### **Coolant**

Be sure that the coolant mixture contains the year-round ratio of 50:50 water and antifreeze/corrosion protection. This mixture provides protection against freezing down to approx. -34 °F (-37 °C). Replace the coolant every four years.

### **Locks**

BMW door lock deicer can be used to free them if frozen. This deicer also contains lubricant.  
After its use, treatment with BMW lock barrel grease is recommended.

### **Rubber seals and components**

To prevent the weather stripping from freezing, apply a spray-on rubber treatment or silicone spray to the door, hood and luggage compartment lid seals.



A full range of car care products is available from your BMW center. ◀

### **Snow chains**

BMW snow chains can be mounted on both summer and winter tires. Mount them in pairs on the rear wheels only and comply with the manufacturer's safety precautions. Do not exceed a maximum speed of 30 mph (50 km/h). In this type of exceptional situation where the snow chains are mounted, deactivate the DSC. Refer to page [88](#).

### **Starting off**

When starting off from a full stop in deep snow or when "rocking" the vehicle to free it, it may be effective to deactivate the DSC system for a short period. Refer to page [88](#).

### **Driving on low-traction road surfaces**

Use smooth, gentle pressure to control the accelerator pedal. Avoid excessive engine speeds and shift to the next higher gear at an early point. On downhill grades or slopes, shift down to the next lower gear at an early point. Maintain an adequate distance between yourself and the vehicle ahead.

# Winter operation

## Brakes

Winter road conditions substantially reduce the amount of traction available between the tires and the road surface. Keep this in mind, because the braking distance increases substantially.

ABS is intended to prevent the wheels from locking during brake applications, thus helping to maintain vehicle stability and steering response.

If the ABS does not respond in a critical braking situation and the wheels lock, reduce the pressure on the brake pedal until the wheels just start to roll again while still maintaining enough force to continue braking. Then increase the pressure, reduce the pressure when the wheels lock, reapply pressure, etc. This staggered braking procedure will reduce stopping distances while helping you maintain steering control. You can then attempt to steer around hazards after you have reduced pressure on the brake pedal.



Do not shift down on slick road surfaces. Doing so could cause the rear wheels to lose traction and skid, which could result in the loss of vehicle control. ◀



Depress the clutch during hard braking on road surfaces that provide only poor or uneven traction. ◀

## Skid control

Depress the clutch and release the accelerator pedal, or place the selector lever of the automatic transmission into the "Neutral" position. Countersteer carefully and attempt to regain control of the vehicle.

## Parking

Engage first or reverse gear. If your vehicle is equipped with an automatic transmission, place the selector lever in Park. On vehicles with manual transmission, also apply the parking brake when parking on inclined surfaces. In order to prevent the parking brake pads from locking due to frost or corrosion, dry them by gently applying the parking brake as the vehicle is coming to a stop. Make sure that following traffic is not endangered.



The brake lamps do not come on when the parking brake is applied. ◀

Changes in steering response, e.g. high steering effort:

Consult a BMW center to have the system checked.



If the power steering fails, increased effort will be required to steer the vehicle. ◀

Only mobile communications systems (cellular phone, two-way radios, etc.) with an output up to 10 watts are permitted. Mobile communications devices not specifically designed for use in your vehicle may trigger malfunctions while operating your vehicle. BMW can neither test nor assume responsibility for every individual product being offered on the market. We recommend that you consult your BMW center before purchasing any device of this kind.

To ensure that your BMW continues to provide reliable and trouble-free operation, do not use a cellular phone or other radio device with an antenna located inside the passenger compartment. The antenna should always be mounted on the outside of the vehicle.



Before loading the vehicle on a car-carrier train or driving it through a car-wash, remove the antenna. ◀

The reception and sound quality obtained from mobile radios varies according to a variety of factors, including the broadcast range of the transmitter and the directional orientation of the antenna. Interference factors such as high-tension power lines, structural or natural obstructions can all lead to unavoidable reception interference, regardless of how well the vehicle sound system is operating.

Climatic factors such as intense solar radiation, fog, rain and snow can also interfere with reception.

Car telephones or cellular phones not approved by BMW can also cause interference in the radio during a telephone call. This phenomenon assumes the form of a low-pitched hum emanating from the speaker system.

Please refer to the supplementary Owner's Manual provided with your car radio\* for detailed information on its use.



## Hardtop\*

It is not necessary to remove the fabric top even in the winter, when the hardtop is generally in constant use. But you can take it off at any time with no problem. Before the fabric top is stored in the convertible top compartment, it must be absolutely dry in order to keep water and mildew from forming.

The hardtop offers reading lamps as well as clothes hooks in the rear, which can be used simply by pressing on them. In addition, a luggage rack system can also be mounted on the hardtop. If you have a problem in this regard, please contact your BMW center.

 When suspending clothing from the hooks, ensure that they will not obstruct the driver's vision. Do not hang heavy objects on the hooks. If you do so, they could cause personal injury during braking or evasive maneuvers. ◀

Two persons are required for installing or removing the hardtop. Work with extreme caution in order to avoid paint damage and damage to the body or hardtop.

To facilitate the installation or removal of the hardtop, you can purchase either a specially designed hardtop lift\* or hardtop roller carrier\* at your BMW center.

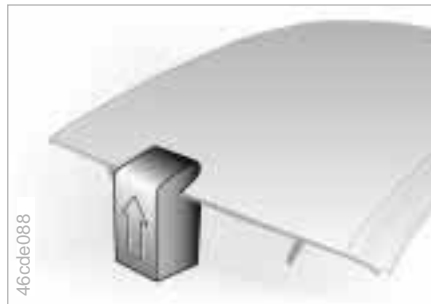

### Storage

 Storing the hardtop on the floor: Push the provided hard foam block toward the front in the center onto the hardtop. The arrow on the foam block has to point upward. ◀



### Installation

- 1 Lower the side windows completely and fold down the sun visors. If necessary, remove the antenna rod to prevent damage
- 2 For vehicles with manual convertible top operation, unlock the convertible top compartment lid and, if necessary, open it somewhat. For vehicles with fully automatic convertible top operation\*, start opening the convertible top compartment lid by pressing the button for the convertible top operation
- 3 Remove the trim pieces on both sides by pulling them toward the back (arrow) and close the convertible top compartment lid again

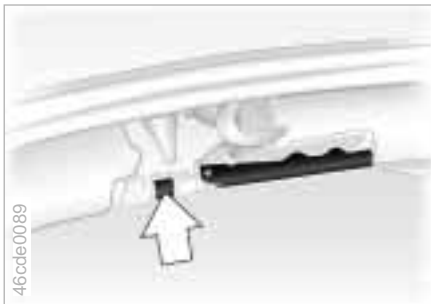

4 Open both front locking levers. To do this press the buttons. The levers will loosen somewhat. Flip the levers open until they hit the stop



- 5 Fold the cover panels that are on the right and left side and below the interior lamps downward before mounting the hardtop. Press against the small bulge on the cover panel. There is a bracket in the cover panel for secure storage of the the trim pieces that have been removed (1)
- 6 Open the red locking lever all the way (2)
- 7 Position the hardtop onto the supports with the help of a second person. Be sure to place the supports right in the brackets provided
- 8 In the back, close the red locking levers by turning them inward until they hit the stop behind the trim. Fold the cover panels back

9 To lock the hardtop in front, keep closing the front locking levers until you hear them engage.

 Raise the hardtop carefully. Be very careful not to displace the seals. Seals that have been accidentally displaced or pulled out lead to leaks. ◀

### Removing

Remove the hardtop in the opposite order of installation.

## Tire inflation pressure

### Information for your safety

The factory approved radial tires are matched to the vehicle and have been selected to provide optimum safety and driving comfort.

It is not merely the tire's service life, but also driving comfort and – above all else – driving safety that depend on the condition of the tires and the maintenance of the specified tire pressure.

Incorrect inflation pressure is a frequent cause of tire damage. It also significantly influences the roadholding ability of your BMW.

 Check tire inflation pressures regularly – including the space-saver spare tire – at least twice a month and before beginning a longer trip (see page 27). If this is not done, incorrect tire pressures can cause driving instability and tire damage, ultimately resulting in accidents. ◀

## Tire condition



### Tire tread – tire damage

Inspect your tires frequently for tread wear, signs of damage and for foreign objects lodged in the tread. Check the tread depth.

Tread depth should not be allowed to go below 0.12 in (3 mm), even though the legally specified minimum tread depth is only 0.063 in (1.6 mm). At a tread depth of 0.063 in (1.6 mm), tread depth indicators (arrow) in the tread-groove base indicate that the legally-permissible wear limit has been reached. Below 0.12 in (3 mm) tread depth, there is an increased risk of aquaplaning, even at relatively moderate speeds and with only small amounts of water on the road.

 Do not drive on a deflated (flat) tire. A flat tire greatly impairs steering and braking response, and can lead to complete loss of control over the vehicle.

Avoid overloading the vehicle so that the permitted load on the tires is not exceeded. Overloading can lead to overheating and increases the rate at which damage develops inside the tires. You could have a blowout as a result. Unusual vibrations encountered during normal vehicle operation can indicate tire failure or some other vehicle defect. This is also true for irregularities in the vehicle's handling characteristics, such as a pronounced tendency to pull to the left or right. Should this occur, respond by immediately reducing your speed. Proceed carefully to the nearest BMW center or professional tire center, or have the vehicle towed in to have it and its tires inspected. Tire damage (up to and including sudden and complete air loss) can endanger the lives of both the vehicle occupants and other drivers on the road. ◀

To maintain good handling and vehicle response, use only tires of a single tread configuration from a single manufacturer. BMW tests and approves wheel/tire combinations. Refer to page [128](#).

### DOT Quality Grades

Treadwear

Traction AA A B C

Temperature A B C

 In addition to the tire grades listed above, all passenger car tires must conform to Federal Safety Requirements as well. ◀

### Treadwear

The treadwear grade is a comparative rating based on the wear rate of the tire when tested under controlled conditions on a specified government test course.

For example, a tire graded 150 would wear one and one-half (1-1/2) times as well on the government course as a tire graded 100. The relative performance of tires depends upon the actual conditions of their use, however, and may depart significantly from the norm due to variations in driving habits, service

practices and differences in road characteristics and climate.

### Traction

The traction grades, from highest to lowest, are AA, A, B, and C.

Those grades represent the tire's ability to stop on wet pavement as measured under controlled conditions on specified government test surfaces of asphalt and concrete. A tire marked C may have poor traction performance.

 The traction grade assigned to this tire is based on straight-ahead braking traction tests, and does not include acceleration, cornering, hydroplaning, or peak traction characteristics. ◀

### Temperature

The temperature grades are A (the highest), B, and C, representing the tire's resistance to the generation of heat and its ability to dissipate heat when tested under controlled conditions on a specified indoor laboratory test wheel.

Sustained high temperature can cause the tire material to degenerate and reduce tire life, and excessive temperature can lead to sudden tire failure. The

Grade C corresponds to a level of performance which all passenger car tires must meet under the Federal Motor Vehicle Safety Standard No. 109. Grades B and A represent higher levels of performance on the laboratory test wheel than the minimum required by law.

 The temperature grade for this tire is established for a tire that is properly inflated and not overloaded. Excessive speed, underinflation, or excessive loading, either separately or in combination, can cause heat buildup and possible tire failure. ◀

### Uniform Tire Quality Grading

Quality grades can be found where applicable on the tire sidewall between tread shoulder and maximum section width. For example:

Tread wear 200 Traction AA  
Temperature A

 Do not use retreaded tires ("caps"). Driving safety may be impaired by their use. This due to the possible variations in casing structures and, in some cases, to their extreme age, factors which can lead to a decrease in their durability. ◀

## Tire replacement

### Tire age

The date on which the tire was manufactured is indicated by the code on the sidewall:

DOT ... 150 indicates that the tire was manufactured during week 15 of the year 2000.

BMW recommends the replacement of all tires when the tires are no more than 6 years old, even if a tire life of 10 years is possible.

Spare tires over 6 years old should be used only in case of emergency. A tire in this condition should be replaced by a new tire immediately, and should not be mounted together with new tires.

## Tire rotation

### Between the axles

The tread wear patterns at the front end differ from those at the rear – the actual patterns will vary according to individual driving conditions. In the interests of safety and maintaining optimal handling characteristics, tire rotation is not recommended.

If a proposed interaxle rotation of tires is based on economic considerations, one should consider whether the costs for the rotation are likely to be recaptured by any increase in the service life of the tires that might be realized. Rotation should always be carried out at short intervals, with a maximum of 3,000 miles (5,000 km). Consult your BMW center for more information.

Should you decide to rotate the tires, it is essential to comply with the following: Rotate tires on the same side only, since braking characteristics and road grip could otherwise be adversely affected.

Following rotation, the tire inflation pressure should always be corrected.



If different tire sizes are mounted on the front and rear axles (refer to page 128), the wheels may not be rotated from one axle to the other. ◀

**The right choice**

Use only tires approved by BMW.  
Refer to the information beginning on page 128.

Due to the high speeds this vehicle can reach, the use of specific brands, specifications and sizes is mandatory. Consult any BMW center for details.  
Comply with local/national regulations.



The correct wheel-tire combination affects different systems, e.g. ABS, ATC\* and DSC, whose function would otherwise be impaired if improper wheel-tire combinations are used.

For this reason, use only tires of the same brand and tread pattern. In the event of a flat tire, for example, remount the approved wheel-tire combination as soon as possible. ◀

**Codes on tires and wheels**

The tire codes will aid you in selecting the correct tire.

The codes on radial tires:

For example: 225/50 R 16 92 W

Nominal width in mm	_____		_____		_____		_____		_____
Aspect ratio in %	_____		_____		_____		_____		_____
Radial tire code	_____		_____		_____		_____		_____
Rim diameter in inches	_____		_____		_____		_____		_____
Load rating	_____		_____		_____		_____		_____
Speed rating (before R on ZR tires)	_____		_____		_____		_____		_____

The speed rating indicates the approved maximum speed for the tire.

Summer tires:

S = up to 112 mph (180 km/h)  
T = up to 118 mph (190 km/h)  
H = up to 130 mph (210 km/h)  
V = up to 150 mph (240 km/h)  
W = up to 167 mph (270 km/h)  
Y = over 167 mph (270 km/h)  
ZR = over 150 mph (240 km/h)

Winter tires:

Q M+S = up to 100 mph (160 km/h)  
T M+S = up to 118 mph (190 km/h)  
H M+S = up to 130 mph (210 km/h)

Codes stamped on light-alloy wheels:

For example: 7 J x 16 H 2

Rim width in inches	_____		_____		_____		_____		_____
Code letter for flange type	_____		_____		_____		_____		_____
Symbol for full-drop center rim	_____		_____		_____		_____		_____
Rim diameter in inches	_____		_____		_____		_____		_____
Hump on the 2 rim shoulders	_____		_____		_____		_____		_____

Protect tire valves from dirt by using screw-on valve stem caps. Dirt in the valves frequently leads to slow leaks.

# Winter tires

## Choosing the right tire

BMW recommends winter tires (M+S radial tires) for driving in adverse winter road conditions. Although all-season tires with the M+S identification provide better winter traction than summer tires with H, V, W Y and ZR speed ratings, they generally fail to provide the same levels of performance as standard winter tires.

In the interests of safe tracking and steering response, install winter tires made by the same manufacturer having the same tread configuration on all four wheels.

Mount only winter tires which have been approved by BMW. Any BMW center will be glad to provide you with information on the best winter tires for your particular driving conditions.

## Do not exceed specified maximum speeds



Never exceed the maximum speed for which winter tires are rated.

Unprofessional attempts by laymen to service tires can lead to damage and accidents.

Have this work performed by skilled professionals only. Any BMW center has the required technical knowledge and the proper equipment and will be happy to assist you. ◀

## Tire condition, tire pressure

Once the tire wears to a tread depth below 0.16 in (4 mm), winter tires display a perceptible decrease in their ability to cope with winter driving conditions, and should be replaced in the interest of safety.

Comply with the specified tire inflation pressures – and be sure to have the wheel and tire assemblies balanced every time you change the tires.

## Storage

Always store tires in a cool, dry place. Store them away from light whenever possible. Protect the tires against contact with oil, grease and fuel.

## Snow chains\*

The use of narrow-link BMW snow chains on summer or winter tires is approved only in pairs and only on the rear wheels. Comply with all manufacturer's safety precautions when mounting the chains.

## 128 Approved wheel and tire specifications

Tire specifications	Steel rim (wheel rim)	Light-alloy wheel
Summer tires		
205/55 R 16 91 H	-	7Jx16
225/50 R 16 92 W	-	7Jx16
225/50 ZR 16	-	7Jx16
205/50 R 17 93 W extra load	-	7Jx17
225/45 R 17 91 W	-	8Jx17
Front: 225/40 ZR 18	-	8Jx18
Rear: 255/35 ZR 18	-	8.5Jx18
Winter tires (M+S)		
205/55 R 16 91 Q/T/H	-	7Jx16
225/50 R 16 92 Q/T/H	7Jx16	7Jx16
205/50 R 17 93 Q/T/H extra load	-	7Jx17
225/45 R 17 91 Q/T/H	-	8Jx17
Space-saver spare tire		
T 115/90 R 16 92 M	3.0Bx16	-
T 125/90 R 16 98 M	3.5Bx16	-
T 125/80 R 17 99 M	3.5Bx17	-

Comply with the specifications for tires and wheels in the vehicle's documents.

If you install tire sizes not approved by the manufacturer, you may have to enter this information in the vehicle documents.

Only light-alloy wheels are to be used for summer tires.

### **Snow chains\***

You cannot mount snow chains on the following tires:

225/50 R 16 92 W  
225/50 ZR 16  
225/40 ZR 18  
255/35 ZR 18  
225/45 R 17 91 W  
225/50 R 16 92 Q/T/H  
225/45 R 17 91 Q/T/H

### **Mixed tires**

For details concerning tire manufacturers for mixed tires, refer to the specifications in the vehicle documents.





## To unlock

Pull the lever located under the left-hand side of the dashboard.

 Do not work on your vehicle without appropriate skills. Always switch off the engine and allow it to cool down before working in the engine compartment. Always disconnect the battery before working on any electrical systems or equipment, especially when these are located within the engine compartment. Comply with all applicable instructions and warnings. Failure to work in an informed, professional manner when servicing components and materials constitutes a safety hazard for vehicle occupants and other road users. If you are not familiar with the guidelines, please have the operations performed by your BMW center. ◀



## To open

Pull the release handle and open the hood.



## To close

Allow the hood to fall from a height of about 12 in (30 cm) so that it audibly engages.

 To avoid injuries, be sure that the travel path of the hood is clear when it is being closed, as with all closing procedures. If it is determined that the hood is not completely closed while driving, stop immediately and close it securely. ◀

## 130 Engine compartment

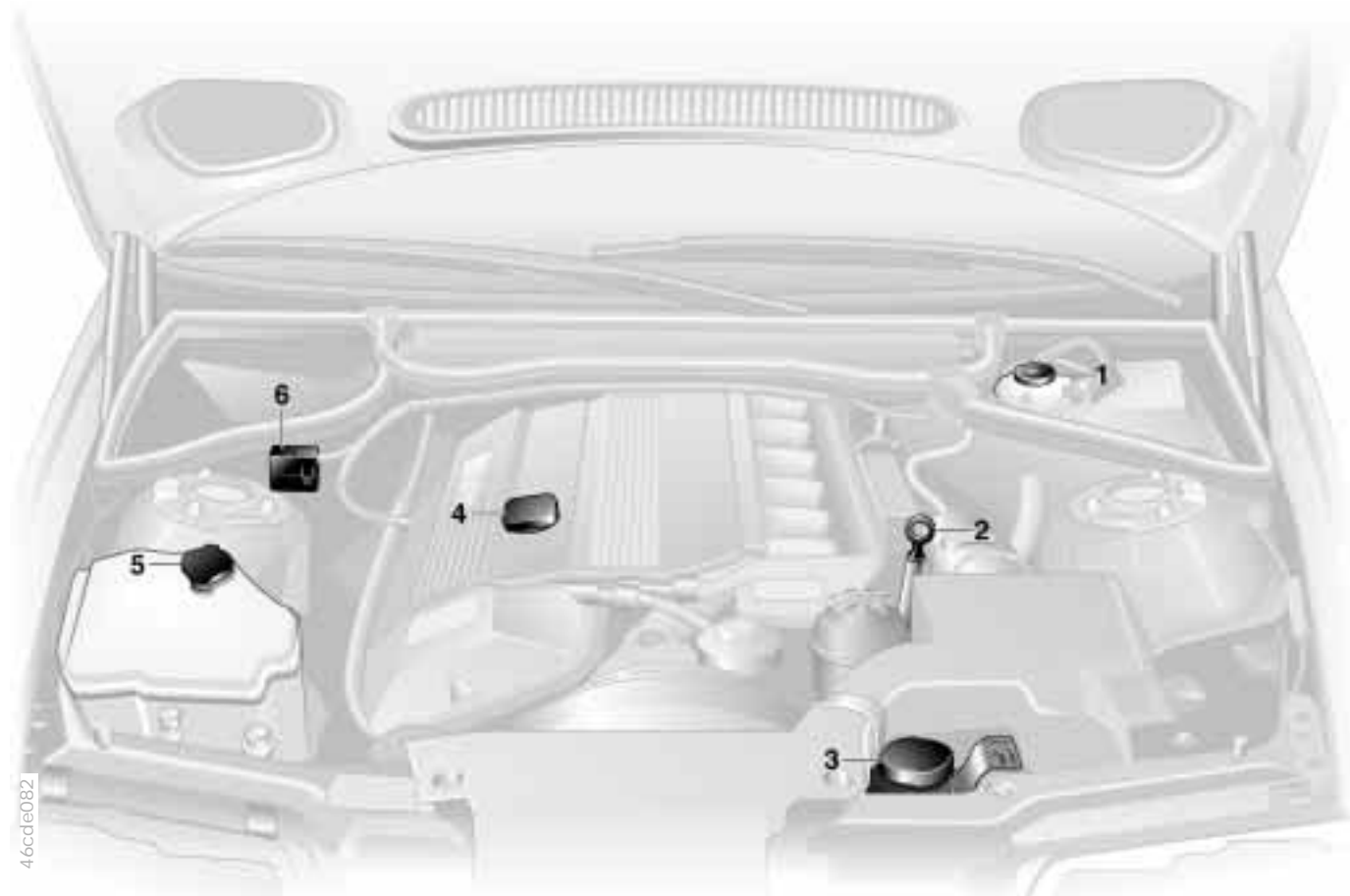

# Engine compartment

- 1 Brake fluid reservoir [136](#)
- 2 Engine oil dipstick [133](#)
- 3 Coolant expansion tank [135](#)
- 4 Engine oil filler neck [133](#)
- 5 Reservoir for the headlamp\* and windshield washer system [132](#)
- 6 Auxiliary terminal for jump starting [168](#)

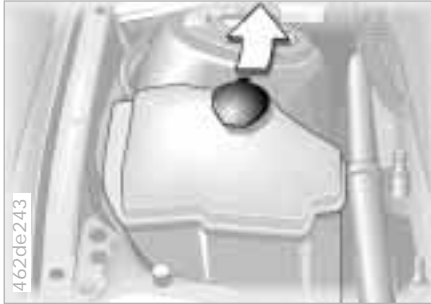

### **Headlamp\* and windshield washer system**

Capacity: approx. 5.6 US quarts (5.3 liters).

Fill with water and – if required – with a washer antifreeze (according to manufacturer's recommendations).

 We recommend that you mix the washer fluid before adding it to the reservoir. ◀



Antifreeze for the washer systems is flammable. For this reason, keep it away from sources of flame and store it in its original container. Store it so that it is inaccessible to children. Comply with the instructions on the containers. ◀

## **Washer nozzles**

### **Windshield washer**

The spray from the nozzles should be directed so as to ensure effective cleaning, even at high speeds. Use a needle to adjust the nozzles as required, or have them adjusted by your BMW center.

### **Headlamp washer system\***

Have this system adjusted by your BMW center as required.



## Checking the oil level

- 1 Park the vehicle on a level surface
- 2 Shut the engine off after it has reached normal operating temperature
- 3 After approx. 5 minutes, pull the dipstick out and wipe it off with a clean lint-free cloth, paper towel, or similar material
- 4 Carefully push the dipstick all the way into the guide tube and pull it out again
- 5 The oil level should be between the two marks on the dipstick.

As with fuel economy, oil consumption is directly influenced by your driving style and vehicle operating conditions.

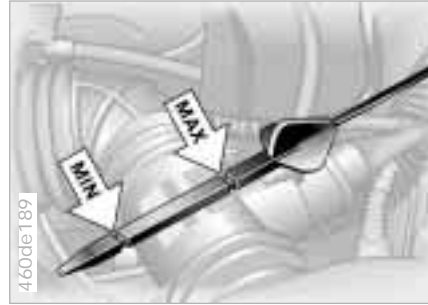

When the oil is between the two marks on the dipstick, there is approx. 1.1 US quarts (1 liter). Do not fill beyond the upper mark on the dipstick. Excess oil will damage the engine.

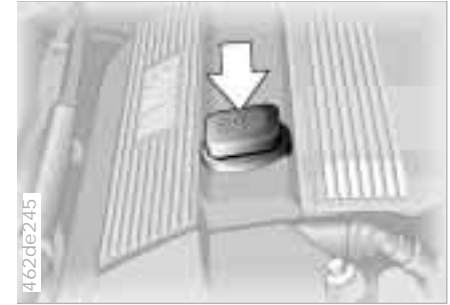

## To add oil

Wait until the level has dropped to just above the lower mark before adding oil. However, never let the oil drop below the lower mark.

 BMW engines are designed to operate without oil additives; the use of additives could lead to damage in some cases. This also applies to the manual transmission, the automatic transmission\*, the differential, and power steering system. ◀

**Specified engine oils**

The quality of the engine oil is extremely important for the function and life of an engine. Based on extensive testing, BMW has approved only certain types of engine oils.

Use only approved "BMW High Performance Synthetic Oil".

If you are unable to obtain "BMW High Performance Synthetic Oil", you may use small volumes of other approved synthetic oils for topping off between oil changes. Use only oils with the specification API SH or higher.



Ask your BMW center for details concerning the specific "BMW High Performance Synthetic Oil" or synthetic oils that have been approved. ◀

You can also call BMW of North America at 1-800-831-1117 or visit this website: [www.bmwusa.com](http://www.bmwusa.com) to obtain this information.

**Viscosity ratings**

Viscosity is the oil flow rating as established in SAE classes.

The selection of the correct SAE class depends on the climatic conditions in the area where you drive your BMW.



Approved oils are in SAE classes 5W-40 and 5W-30. ◀

These kinds of oil may be used for driving in all outdoor temperatures.

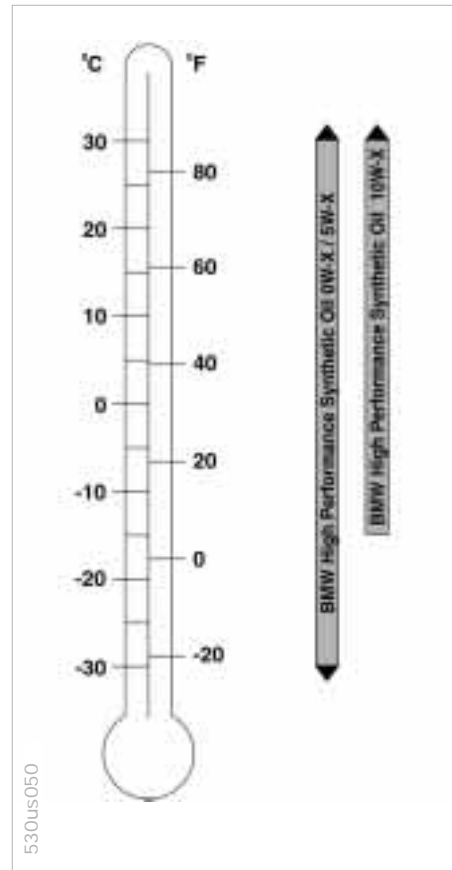

## Engine oil

 Always comply with all environmental protection guidelines and regulations when disposing of used oil. ◀

Recommendation: have the oil changed by your BMW center only.

 Continuous exposure to used oil has caused cancer in laboratory testing. For this reason, thoroughly wash any areas of skin that come into contact with oil using soap and water. Always store oils, grease and similar materials so that they are inaccessible to children. Comply with warning labels and information on containers. ◀

## Coolant

 Do not add coolant to the cooling system when the engine is hot. If you do, escaping coolant can cause burns.

To avoid the possibility of damage later on, never use anything other than factory approved nitrite and amino-free extended-duty antifreeze with corrosion inhibitor. Your BMW center is familiar with the factory specifications. Antifreeze and anticorrosion agents are hazardous to health. You should always store them in their original container and in a location that is inaccessible to children. Extended duty antifreeze with corrosion inhibitor contains ethylene glycol, a flammable substance. Therefore, do not spill antifreeze with corrosion inhibitor on hot engine parts. It could ignite and cause serious burns. ◀

 Comply with the applicable environmental laws regulating the disposal of extended-duty antifreeze with corrosion inhibitor. ◀



### Checking coolant level

Correct coolant level when the engine is cold (approx. 68 °F or +20 °C):

Unscrew the cap from the expansion tank.

The coolant level is correct when the upper end of the red float is at least even with the upper edge of the filler neck (refer to the arrow in the illustration), but no more than 0.8 inches (2 cm) above it – that is, up to the second mark on the float (refer also to the schematic diagram next to the filler neck).

**Adding coolant**

Wait until the engine cools before removing the cap from the expansion tank. The coolant gauge needle in the instrument cluster must be located in the blue zone. If it is not, there is a danger of scalding.

- 1 Turn the cap slightly counterclockwise in order to allow accumulated pressure to escape. Then open the cap
- 2 If the coolant is low, slowly add coolant until the correct level is reached – do not overfill.

The coolant is a mixture of water and extended-duty antifreeze with corrosion inhibitor. Always maintain the prescribed all-season 50:50 mixture ratio for year-round protection against internal corrosion. No other additives are required.

Replace the coolant every four years.

**Brake fluid**

If the warning lamp for the brake system comes on and the parking brake has been released:

Check the brake fluid level. Fill it to the top mark ("MAX") if necessary.

For adding brake fluid or for determining and correcting the cause of brake fluid loss, consult your BMW center. Your BMW center is familiar with the specifications for factory-approved brake fluids (DOT 4).

Brake fluid loss can result in extended pedal travel. Comply with the information provided on page [117](#).

 Brake fluid is hygroscopic, that is, it absorbs moisture from the air over time.

In order to ensure the safety and reliability of the brake system, have the brake fluid changed every two years by a BMW center. Refer also to the Service and Warranty Information Booklet (US models) or the Warranty and Service Guide Booklet (Canadian models).

Brake fluid is toxic and damages the vehicle's paint. You should always store it in its original container and in a location inaccessible to children.

Do not spill the fluid and do not fill the brake fluid reservoir beyond the "MAX" mark. The brake fluid could ignite upon contact with hot engine parts and cause serious burns. ◀



Comply with the applicable environmental laws regulating the disposal of brake fluid. ◀





In the engine compartment, on the right-hand strut dome (arrow).



The BMW Maintenance System has been designed as a reliable means for providing maximum driving and operating safety – and as cost effectively as possible for you. Once again, with respect to the previous version, maintenance costs were able to be reduced due to technical innovations.

Please keep in mind that regular maintenance is not only necessary for the safety of your vehicle, but also plays a significant role in maintaining its resale value.

### **Service Interval Display**

Advanced technology is employed to calculate the optimal maintenance intervals. These are then indicated in the

Service Interval Display. While conventional systems rely on distance traveled alone to determine when service is due, the BMW Maintenance System has for years considered the actual conditions under which the vehicle operates, because miles can be traveled in many different ways:

From a maintenance point of view, 62,000 miles (100,000 km) of short-distance urban driving are not the same as 62,000 miles (100,000 km) of long-distance highway driving.

In response to this fact, the BMW Maintenance System monitors operating conditions as the basis for determining the optimum service intervals for your individual vehicle. The BMW Maintenance System includes the Engine Oil Service and Inspections I and II.

Determining maintenance intervals according to the actual use of the vehicle covers every kind of operating situation. Even those who drive very little – significantly less than 6,000 miles (10,000 km) annually – should still have the engine oil changed at least every 2 years because engine oil deteriorates over time, regardless of the amount of wear and tear to which it has been subjected.

### **Service and Warranty Information Booklet (US models)/Warranty and Service Guide (Canadian models)**

For additional information on maintenance intervals and procedures, please refer to the Service and Warranty Information Booklet (US models) or to the Warranty and Service Guide (Canadian models).

As a precaution against rust, it is advisable to have the body checked for damage from rocks or gravel at the same time, depending upon operating conditions.

 Have your BMW center perform maintenance and repair.

Your BMW center is always up-to-date on the latest maintenance work and repair techniques and equipped with the required special tools. In addition, checking parts known from experience to be subject to wear is a permanent part of the maintenance specifications. Be sure that all maintenance work is confirmed in the Service and Warranty Information Booklet (US models) or the Warranty and Service Guide (Canadian models). These entries will constitute your proof that the vehicle has received regular maintenance. They are also required for warranty claims. ◀

## Caring for your vehicle

### Washing your vehicle

You can wash your BMW at an automatic car wash, even when it is new. Brushless systems are preferable (refer to page 144 as well).

Wipe away tough dirt and loosen and remove dead insects before washing the vehicle.

In order to avoid spots, do not wash the vehicle when the hood is warm, or during or immediately after exposure to strong sunlight.

When using an automatic car wash, be sure that:

- ▷ The car wash system is suited for the dimensions of your vehicle
- ▷ No damage will occur to vehicles with attached body accessories (such as spoilers or antennas). Consult the car wash operator if necessary
- ▷ The wheels and tires of your vehicle cannot be damaged by the conveyance devices of the car wash system
- ▷ The vehicle is cleaned with minimum brush pressure, and that ample water is available for washing and rinsing.

Vehicles with rain sensor\*:

Clean the windshield regularly. Wax from automatic car washes or insects can cause the rain sensor\* to malfunction.



Turn the rain sensor\* off (refer to page 78) when passing through an automatic car wash. Failure to do so could result in damage caused by unintended wiper activation. ◀

Parts of the vehicle that are inaccessible to the automatic washer – such as door sills, door and hood edges, etc. – should be cleaned by hand.

In the winter months, it is especially important to ensure that the vehicle is washed on a regular basis. Large quantities of dirt and road salt are difficult to remove, and they also damage the vehicle.



If spray wands or high-pressure washers are used, be sure to maintain an adequate distance between the spray source and the vehicle's surface. Inadequate distance and excessive pressure can damage or weaken the finish, making it more susceptible to subsequent attack. In addition, moisture could penetrate to vehicle components, leading to long-term damage. ◀



When cleaning the headlamps, please observe the following: Do not clean by wiping with a dry cloth (scratches). Never use abrasives or strong solvents to clean the covers. Remove dirt and contamination (such as insects) by soaking with BMW Car Shampoo and then rinsing with plenty of water. Always use a deicer spray to remove accumulated ice and snow – never use a scraper. ◀



After washing the vehicle, apply the brakes briefly to dry them. Braking efficiency might otherwise be reduced by the moisture and the brake rotors could also corrode. ◀

### **Exterior finish**

To provide effective corrosion protection, multilayer paintwork is applied at the factory. Cathaphoretic immersion priming techniques are supplemented with special body-cavity protectants, by applying specially developed and extensively tested materials.

A layer of flexible PVC is first applied to the undercarriage. Following this, a comprehensive undercoating treatment with a wax-based protectant is applied. Regular maintenance makes an important contribution to maintaining the safety and value of your vehicle.

Increasing awareness of the effects of harmful environmental factors on vehicle finishes have led paint and vehicle manufacturers to initiate programs designed to further improve the durability of their finishes. Despite this, environmental factors that occur locally or regionally can have negative effects on the finish of your vehicle. Use the factors to determine the frequency and extent of your efforts to maintain the vehicle finish.

Depending upon material and type of impact (perforation of paint layer), physical stresses from sand, road salt,

gravel, etc., can cause corrosion to start extending beneath the finish, starting at the point of impact.

Road dirt, tar spots, dead insects, animal droppings (strong alkali effect) and tree excretions (resins and pollen) all contain substances capable of causing damage when allowed to remain on the finish of your vehicle for any extended period of time. This includes spots, etching, flaking, and separations in the top coat.

In industrial areas, flue dust deposits, lime, oily soot, precipitation containing sulfur-dioxide (acid rain) and other environmental pollutants will damage the vehicle's finish unless adequate care is provided – even though this is generally limited to the outside horizontal surfaces.

In coastal regions, high levels of atmospheric salt and humidity promote corrosion.

In tropical zones, temperatures of over 105 °F (+40 °C) in the shade prevail, in addition to heavy ultraviolet radiation and high humidity. Under these conditions, light paints can reach temperatures up to 175 °F (+80 °C) and dark paints up to 250 °F (+120 °C).

### **Caring for the vehicle finish**

Regular washing is a preventive measure against long-term effects from substances that are harmful to the vehicle's finish, especially if you drive your vehicle in areas with high levels of air pollution or aggressive natural substances (tree resins, pollen).

Nevertheless, you should immediately remove especially aggressive substances. Failure to do so can lead to changes in the paint's chemical structure or to discoloration. Gasoline spilled during refueling, oil, grease and brake fluid should always be cleaned away immediately, as should bird droppings.

Any contamination remaining on the surface of the vehicle will be especially conspicuous after washing. Use cleaning fluid or alcohol with a clean cloth or cotton pad to remove. Remove tar spots with tar remover. After cleaning, the affected areas should be waxed to ensure continued protection.



Use the cleaning and car-care products available at your BMW center. ◀

## Caring for your vehicle

### Waxing your vehicle

Protect the finish using only carnauba or synthetic-based waxes.

The best way to determine when the finish needs to be waxed is by noting when water stops beading on the surface.

You can use a glass cleaner to remove any wax or silicone that may have been left on the windows during waxing.



Use the cleaning and car-care products available at your BMW center. ◀

### Paint damage

You can touch up small areas of paint damage with a BMW spray paint or a BMW touchup stick.

The paint color code for your vehicle is provided on a sticker located on the right hand side under the hood and on the first page of your Service and Warranty Information Booklet (US models) or Warranty and Service Guide (Canadian models).

Damage caused by flying stones, scratches, etc., must be touched up without delay to prevent rust from forming.

If corrosion has started to form in an area with paint damage, remove all rust and clean the area. Then prime the area with a BMW Primer Stick. Finally, apply the finish coat. Wait a few days, then polish the repaired area. Finish by applying a wax preservative.

More extensive paint damage should be repaired professionally in accordance with the manufacturer's instructions. Your BMW center uses original BMW finish materials in accordance with approved repair procedures.

### Caring for other vehicle components and materials

Light-alloy wheels should be treated with alloy wheel cleaner, especially during the winter months. However, do not use aggressive products containing acids, strong alkalis or abrasives. Do not use steam cleaners operating at temperatures above 140 °F (+60 °C). Follow the manufacturer's instructions.

If your vehicle has chrome parts\*, such as the window frames and door handles, clean these parts carefully with ample clean water and a shampoo supplement if desired, especially if they have an accumulation of road salt. Use a chrome polish for an additional treatment.

You can use window and glass cleaner to clean inside window surfaces and mirrors without smearing and streaking. Never use polishing pastes or abrasive (quartz) cleansers on mirror lenses.

Plastic components, vinyl upholstery, the headliner (with the hardtop\*), lamp lenses, the clear cover for the instrument cluster and dull black surfaces can be cleaned with either water and possibly a cleaner designed to be used on plastic. Do not soak the seats or the headliner (this applies to the hardtop\*). Never use solvents such as lacquer thinner, heavy-duty grease remover, fuels, or similar substances.

Rubber components should be cleaned with water only; a rubber treatment or silicone spray may also be applied.

Clean the wiper blades with soapy water. The wiper blades should be replaced twice a year – before and after winter. This is especially important for vehicles with a rain sensor\*.

 Use only wiper blades approved by BMW. ◀

Do not remove safety belts to clean them. Clean them with mild soapy water only. Do not use chemicals or dry cleaners to clean safety belts, since this could damage the belt fabric.

After cleaning, never allow the inertia reel to retract the belts until they are completely dry. Dirty safety belts prevent the inertia reel mechanism from retracting the strap properly, and thus constitute a safety hazard.

Heavily soiled floor carpets and mats\* can be cleaned with an interior cleaner. The floor mats can be removed from the vehicle for cleaning.

Use only a damp cloth to clean trim panels made of real wood\* and other parts constructed of real wood\*. Follow up by drying with a soft cloth.

 Use the cleaning and car-care products available at your BMW center. ◀

### **Care of upholstery materials**

Depressions in the upholstery that result from everyday use can be brushed smooth by brushing against the nap with a lightly dampened brush.

The tendency of the pile to lie in a particular direction on velour upholstery is not a quality defect, and, just as on home textiles or clothing, cannot be avoided.

Lint on upholstery materials, textile or leather remnants that have been worn into the upholstery may be removed with a lint brush or a Velcro brush. A cleaning glove is available for especially "stubborn" lint. Stains and fairly large areas of dirt should be cleaned off without delay, using lukewarm water and an interior cleaner, stain remover or appropriate cleaning fluid. Brush the fabric afterwards to restore its appearance.

If the vehicle is to be stored for an extended period, or if it is exposed to intense sunlight, cover all the seats or the windows to prevent fading.

 Use the cleaning and car-care products available at your BMW center. ◀

## Caring for your vehicle

The buildup of an electrostatic charge on the seat covers, particularly if atmospheric humidity is low, can give the occupants an unpleasant electric shock if they touch metal body parts after leaving the vehicle. Although this not dangerous in any way, it can be avoided by touching a bare or polished metal part of the vehicle while getting out.

### Leather care

The leather upholstery\* used by BMW is a natural product of the highest quality, processed using state-of-the-art methods to ensure that it will maintain its high quality for years to come, provided that it is properly cared for.

Because this product is manufactured using natural materials, you must make allowance for its special characteristics and for the peculiarities of its use and care.

Regular periodic cleaning and care are essential, as dust and road dirt act as abrasives in the pores and creases of the material. This leads to wear spots and premature brittleness on the surface of the leather. We therefore suggest that you clean the leather with a vacuum cleaner or cloth at frequent intervals.

For cleaning, use BMW leather cleaning foam.

Since dirt and grease gradually attack the protective layer of the leather, the cleaned surfaces should be treated with BMW leather care agent. This also acts as an antistatic agent.

For protection against dampness or moisture, treat the leather with an impregnating agent made by BMW.

We recommend that you perform this procedure twice a year on leather exposed to normal use.

Spills should be wiped up immediately. Remove grease and oil stains by dabbing with spot remover. Avoid rubbing.

If the upholstery is to be exposed to intense sunlight or if the vehicle is to be stored for an extended period, cover all leather surfaces (or, better yet, the windows) to prevent fading.



Use the cleaning and car-care products available at your BMW center. ◀



Cleaning agents can contain substances that are dangerous or pose health risks. For this reason, always comply with the warnings and danger labels on the packaging. When cleaning the vehicle's interior, open the doors or windows (if the convertible top has been closed). Never clean your vehicle with solvents or other materials not specifically intended for this purpose. ◀

### **Care**

The appearance and life of the convertible top are highly dependent on its proper care and operation. You should pay particular attention to the following instructions if your vehicle has a light-colored top.

Protect the vehicle from exposure to intense sunlight whenever possible by parking it in the shade. This will help to prevent the paint, rubber and fabric-covered parts from being attacked.

Never fold up the convertible top and store it in the convertible top compartment when wet, dirty or frozen, as mildew stains and rub spots may result.

To prevent mildew stains from forming, do not leave the top closed up in the convertible top compartment for long periods of time.

If the vehicle will be parked for lengthy periods in an enclosed space, be sure that the convertible top is dry and that there is adequate ventilation.

Clean off bird droppings immediately, since they attack the convertible top and cause the rubber seals to swell due to their caustic characteristics.

Besides water, treat rubber seals only with talcum powder, rubber care products or silicone spray, particularly when they feel dry or tend to stick.

Eliminate noises, e.g. squeaks, using a spray lubricant.

Depressions and discoloration may occur in the convertible top as a result of improper maintenance and cleaning or as the result of stresses from excessive use. The convertible top and its seams may also develop leaks. These occurrences are not covered by the warranty. For repairs, please consult your BMW center.

### **Washing your vehicle**

You can take your BMW convertible through automatic car washes. Brushless car washes are preferred.

If a brushless car wash is unavailable and a brush car wash must be used, modern systems with soft brushes are preferable. Do not opt for special waxing programs. The small amount of beading wax always used in automatic car washes will not harm your vehicle's finish.

Whenever the vehicle is very dirty, which is especially visible on light-colored convertible tops, use the BMW Convertible Cleaning Set to clean it. Please proceed as follows:

Spray the convertible top with the cleaning agent and then rub with a well-dampened sponge using circular motions until a foam develops. Then you can finish washing the vehicle in an automatic car wash. After three to five washings the convertible top should be treated with a special impregnating spray. Please follow the instructions on the spray can.



## Cleaning and caring for your convertible top

Do not use spot removers, paint thinners, solvents, gasoline or similar substances for removing spots from the convertible top or from the rear window. These materials destroy the rubber layer, which will lead to leaks. Use only BMW-approved cleaners.



Cleaning agents can contain substances that are dangerous or that pose health risks. For this reason, always comply with the warnings and danger notices on the packaging. Open the doors or windows on your vehicle when cleaning the interior. Never clean your vehicle with solvents not specifically intended for it. ◀



### Getting your vehicle ready for cleaning

In order to maintain free access to your convertible top compartment, rest the rear convertible top bar against the convertible top compartment lid (refer to illustration).



Release the lid locks for the convertible top first; refer to page [45](#) or [50](#). ◀

### Hardtop\*

Please note and follow the information about caring for your vehicle, which starts on page [139](#).

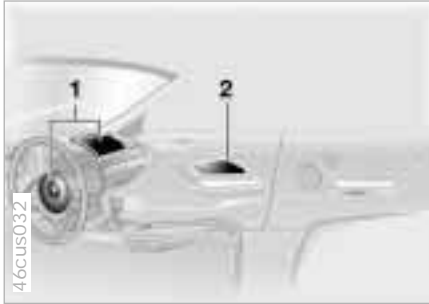

- 1 Front airbags for driver and passenger
- 2 Side airbags (front)

### **Important safety notices**

 Do not attempt to remove the gas generators for the airbag restraint system from the vehicle. Testing and servicing must be performed by trained technicians only. In the event of a malfunction, deactivation or triggered activation (as a response to an accident) of the airbag restraint system, consult your BMW center for repairs or service operations.

Do not modify or tamper with either the wiring or the individual components in the airbag system. This includes the upholstered covers on the steering wheel, in the instrument panel and in the side trim panels of the doors. Do not apply adhesive materials to these components or cover or modify them in any way. Do not attempt to remove or dismantle the steering wheel.

To ensure compliance with official safety regulations, have a BMW center dispose of airbag generators.

Unprofessional attempts to service the system could lead to failure in an emergency or undesired airbag activation, either of which could result in personal injury. ◀

## Vehicle storage



If you intend to store the vehicle for more than three months, have the maintenance operations described on this page performed. ◀

### Preparations for storage

Have your BMW center perform the following procedures:

- 1 Clean and apply a rustproofing agent or other treatment to the engine, engine compartment, undercarriage, axles and major components in accordance with approved repair procedures. Washing the vehicle, any interior cleaning and subsequent paint-and chrome care, and cleaning any rubber seals for the hood and doors, should be carried out in compliance with approved procedures as well
- 2 Change engine oil and oil filter at operating temperature. As an additional corrosion protection measure, an anticorrosive agent can be added to the engine when refueling in accordance with the manufacturer's instructions
- 3 Check the coolant level and concentration and top off if necessary
- 4 Fill the fuel tank completely to prevent the formation of condensation
- 5 Increase the tire inflation pressure to 51 psi (350 kPa).

### Before parking the vehicle

- 1 Dry the parking brake and footbrakes completely to keep the brake discs and drums from corroding
- 2 Park the vehicle in a covered, dry, and well-ventilated space. Place the transmission in first gear or set the selector lever to the "P" position. Chock the wheels to prevent the vehicle from rolling if necessary. Do not apply the parking brake
- 3 Remove the battery, charge it completely and store it in a cool (but frost-free) room
- 4 Remove the hardtop\* and store it separately. Refer to page [121](#)
- 5 Close the convertible top.

### During storage

Recharge the battery every six months. If it is not recharged, it will not be serviceable. Every time the battery drains, especially over extended periods, its service life is reduced.

### Removing the vehicle from storage

Recharge the battery if the "Magic Eye"\* turns black. Refer to page [162](#). Then have Inspection I performed by your BMW center, including a brake fluid replacement if necessary. Refer to the Service and Warranty Information Booklet (US models) or the Warranty and Service Guide (Canadian models).

Any BMW center will be glad to inform you of the advisability, legal requirements and factory recommendations regarding technical modifications on your vehicle. For this purpose, the BMW center will require the Vehicle Identification Number and, in some cases, the engine number as well.

### **Light-Emitting Diodes (LEDs)**

Light-emitting diodes installed behind translucent lenses serve as the light source for many of the controls and displays in your vehicle. These LEDs resemble conventional lasers and are classified by law as "Class 1 light-emitting diodes".



Do not remove the protective lens and avoid staring directly at the unfiltered beam for extended periods (several hours). To do so could result in inflammation of the iris. ◀

## OBD interface socket



The interface socket for the onboard diagnostics is located on the driver's side at the left-hand bottom of the dashboard and under a cover. The cover has the letters "OBD" on it.

The purpose of the OBD system is to ensure proper emission control system operation for the life of the vehicle by monitoring emission-related components and systems for deterioration and malfunction.



An illuminated indicator informs you of the need for service, not that you need to stop the vehicle. Your system should be checked by your BMW center at the earliest possible opportunity.

If the indicator blinks or flashes, this indicates a high level of engine misfire. Reduce speed and contact your nearest BMW center immediately. Severe engine misfire over only a short period of time can seriously damage emission control components, especially the catalytic converter.



Warning lamp: "Service Engine Soon" for Canadian models



When the fuel filler cap is not properly tightened, the OBD system can detect the vapor leak and the indicator will light up. If the fuel filler cap is then tightened, the indicator will usually go out after a short period of time. ◀



**Replacement procedures:**

Onboard tool kit [152](#)  
Windshield wiper blades [152](#)  
Lamps and bulbs [152](#)  
Changing a wheel [159](#)  
Battery [162](#)  
Fuses [165](#)

**In case of electrical malfunction:**

Fuel filler door [165](#)  
Fully automatic convertible top [166](#)

**Assistance, giving and receiving:**

Jump-starting [168](#)  
Towing the vehicle [169](#)

[Overview](#)[Controls and features](#)[Operation, care and maintenance](#)[Owner service procedures](#)[Advanced technology](#)[Technical data](#)[Index](#)

Overview

Controls

Car care

Repairs

Technology

Data

Index



The onboard tool kit is located in the luggage compartment lid.

Loosen the wingnut to open.

## Windshield wiper blades



- 1 Rotate the wiper arm completely out from the windshield
- 2 Position the wiper blade at an angle and pull the release spring (arrow)
- 3 Fold the wiper blade down and unhook it toward the windshield
- 4 Pull the wiper blade past the wiper arm toward the top
- 5 Insert a new wiper blade and apply pressure until you hear it engage.

 Use only BMW-approved wiper blades. ◀

## Lamps and bulbs

The lamps and bulbs are essential factors contributing to the safety of your vehicle. For this reason, follow the instructions below carefully when replacing a bulb. If you are not familiar with any of the procedures, consult your BMW center.

 Do not touch the glass portion of a new bulb with your bare hands since even small amounts of impurities burn into the surface and reduce the service life of the bulb. Use a clean cloth, paper napkin, or a similar material, or hold the bulb by its metallic base. ◀

A replacement bulb set is available from your BMW center.

 Whenever working on the electrical system, switch off the electrical accessory you are working on or disconnect the cable from the negative terminal of the battery. Failure to do this could result in short circuits. To prevent injuries and damage, comply with any instructions provided by the bulb manufacturer. ◀



# Lamps and bulbs



The illustration shows the left-hand side of the engine compartment.

## 1 Low beams

H7 bulb, 55 watts

## 2 High beams

H7 bulb, 55 watts

 The H7 bulb is pressurized. Therefore, wear safety glasses and protective gloves. Failure to comply with this precaution could lead to injury if the bulb is accidentally damaged during replacement. ◀

- 1 Turn the bulb holder to the left and remove it
- 2 Remove and replace the bulb.



When cleaning the headlamps, please observe the following: Do not clean by wiping with a dry cloth (scratches). Never use abrasives or strong solvents to clean the covers. Remove dirt and contamination (such as insects) by soaking with BMW Car Shampoo and then rinsing with plenty of water. Always use a deicer spray to remove accumulated ice and snow – never use a scraper. ◀

## Xenon lamps\*

The service life of these bulbs is very long and the probability of a failure is very low, provided that they are not switched on and off an unusual number of times. If one of these bulbs should nevertheless fail, it is possible to continue driving with great caution using the fog lamps, provided traffic laws in your area do not prohibit this.



Because of the extremely high voltages involved, any work on the lighting system should be performed only by technicians with the appropriate qualifications. Failure to comply with this creates a risk of fatal injury. ◀



The illustration shows the left-hand side of the engine compartment.

### **Parking lamps**

5 watt bulb

- 1 Turn the bulb holder to the left (arrow) and remove it
- 2 Remove and replace the bulb.



### **Front turn signal indicator**

21 watt bulb

- 1 Using a screwdriver, release the inner hook by going through the upper opening
- 2 Remove the lamp by pulling it toward the front
- 3 Applying light pressure, turn the bulb to the left. Remove and exchange the bulb



- 4 Insert the 2 pins on the lamp into the guides on the vehicle
- 5 Push the lamp in. Carefully apply pressure until you hear it engage.



## Side turn signals

5 watt bulb

- 1 Use finger pressure against the rear end of the lens (arrow) to press it forward for removal
- 2 Apply gentle pressure to the bulb while turning it to the left to remove.



## Front fog lamps

HB4, 55 watt bulb

 The bulb is pressurized. Therefore, wear safety glasses and protective gloves. Failure to comply with this precaution could lead to injury if the bulb is accidentally damaged during replacement. ◀

Please contact a BMW center in the event of a malfunction.

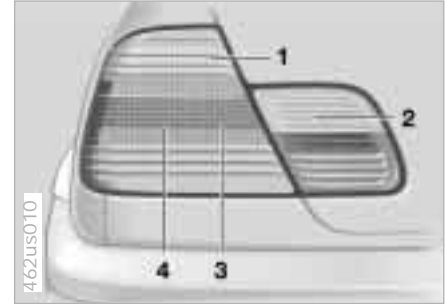

## Tail lamps

Tail lamps (4): Bulbs 21/4 watts  
 Remaining bulbs: 21 watts

- |                          |        |
|--------------------------|--------|
| 1 Turn signal indicators | yellow |
| 2 Backup lamps           | white  |
| 3 Tail lamp              | red    |
| 4 Tail lamp/Brake lamp   | red    |

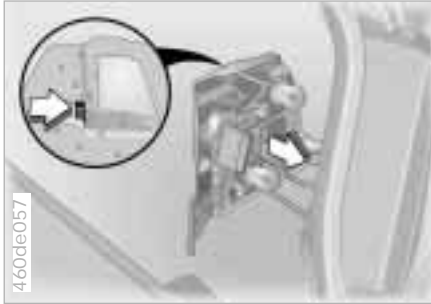

The illustration shows the right-hand luggage compartment opening.

**Bulbs in the fender:**

All of the bulbs are integrated into a central bulb holder.

- 1 Release the bulb holder (arrow, partial view) and remove
- 2 Unplug the power supply receptacle. Set the bulb holder aside (on the luggage compartment floor, for example)
- 3 Applying light pressure, turn the bulb to the left. Remove and exchange the bulb
- 4 Plug in the power supply receptacle
- 5 Position the bulb holder for reinstallation. Apply gentle pressure on the button (arrow, partial view) until you hear it engage.



**Bulbs in the luggage compartment lid:**

- 1 Using a screwdriver, loosen the clip



- 2 Fold the trim panel down (arrow 1). Disengage the bulb holder (arrow 2) and remove it
- 3 Applying light pressure, turn the bulb to the left. Remove and exchange the bulb
- 4 Press the bulb holder into position until you hear it engage
- 5 Reinstall the trim with the clip.



## Center brake lamp

LED strip in the luggage compartment lid.

Please contact a BMW center in the event of a malfunction.



## License plate lamps

5 watt bulb

- 1 Place a screwdriver in the slot and press toward the left (arrow) to release the lens
- 2 Replace the bulb.



## Interior lamps

Front

Interior lamps (6 watt bulb) with reading lamps (2 x 6 watt bulbs)

- 1 Using a screwdriver, press the lamp out toward the front
- 2 Turn the bulb holder to the left and remove it
- 3 Remove and replace the bulb.



In the rear (only with the hardtop\*)

Interior lamps (6 watt bulb)

Reading lamp (6 watt bulb)

- 1 Pry the lamp out using a screwdriver
- 2 Turn the bulb holder to the left and remove it
- 3 Remove and replace the bulb.

### **Footwell lamps**

5 watt bulb

- 1 Pry the lamp out using a screwdriver
- 2 Replace the bulb.

### **Glove compartment lamp**

5 watt bulb

- 1 Pry the lamp out using a screwdriver
- 2 Replace the bulb.

### **Luggage compartment lamps**

One lamp each in the bulb holder of the tail lamp assembly: 10 watt bulb.

- 1 Apply a screwdriver to the recess and remove the lens
- 2 Replace the bulb.

## Changing a wheel

 Safety measures in the event of a flat tire or wheel change:

Stop the vehicle as far as possible from passing traffic. Park on a firm, flat surface. Switch on the hazard flashers.

Turn the steering wheel to the straight-ahead position, remove the key and engage the steering lock. Shift into 1st or reverse (selector lever in "Park" with automatic transmission) and engage the parking brake.

Have all passengers leave the vehicle and remain well away from your immediate working area (behind a guardrail, for instance).

If a warning triangle\* or portable hazard warning lamp is available, set it up on the roadside at an appropriate distance from the rear of the vehicle. Comply with all safety guidelines and regulations.

Change the wheel only on a level, firm surface that is not slippery. Avoid jacking the vehicle on a soft or slippery support surface (snow, ice, loose gravel, etc.), as it could slide sideways.

Position the jack on a firm support surface.

Do not place wooden blocks or similar objects under the jack, otherwise, the jack might not be able to reach its full support capacity because of the limited height.

Do not lie under the vehicle or start the engine when the vehicle is supported by the jack. Failure to comply with this creates a risk of fatal injury. ◀

Your BMW has a space-saver spare tire for temporary use to ensure your mobility.

 To remove the space-saver spare tire, lift the floor panel in the luggage compartment completely out (refer to page 41). ◀



### What you will need

In order to avoid rattling noises later, note the position of the tools when you remove them and return them to their original position when you are through using them.

#### ▷ Jack (1)

Raise the floor panel in the luggage compartment (refer to page 41) and unscrew the red wing nut (arrow). When you have completed your work, screw the jack all the way back down. Fold the handle back and insert it into its holder

#### ▷ Wedge (2)

The wedge, or wheel chock, is located behind the jack on the luggage compartment's rear wall. Loosen the wing nut to remove it

## 160 Changing a wheel

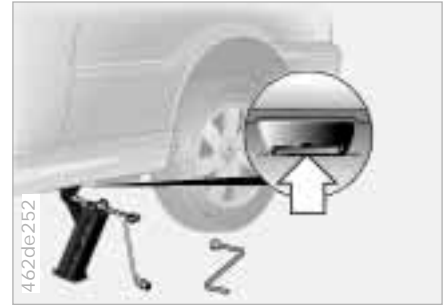
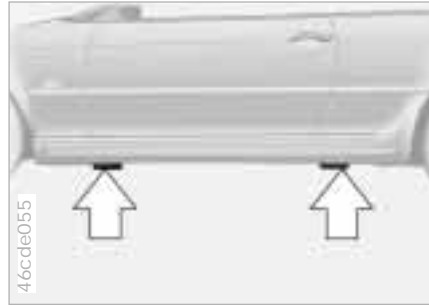

- ▷ Space-saver spare tire  
Located next to the jack.  
Loosen the wing nut (arrow) by hand, remove the storage tray and take out the spare wheel
- ▷ Lug wrench – is in the onboard tool kit on the underside of the luggage compartment lid (refer to page 152).

### Procedure

- 1 Read and comply with the safety precautions provided on the previous page
- 2 Secure the vehicle against rolling: Place the wedge against the rear surface of the front tire on the side opposite the side being raised. If the vehicle is parked on a downward slope, place the wedge securely in front of the tire. If the wheel must be changed on a surface with a more severe slope, take additional precautions to secure the vehicle against rolling
- 3 If your wheels are equipped with full wheel covers\*, reach into the ventilation openings and pull the cover off
- 4 Loosen the lug bolts 1/2 turn
- 5 Position the jack at the jacking point closest to the flat tire (refer to the center illustration) so that the jack base is vertically below the jacking point and the entire surface of the head of the jack will move into the square recess of the jacking point (refer to the illustration detail) when the jack is cranked
- 6 Jack the vehicle up until the wheel you are changing is raised from the ground
- 7 Unscrew the lug bolts and remove the wheel
- 8 Remove mud or dirt accumulations from the mounting surfaces of the wheel and hub. Clean the lug bolts







- 9 Position the new wheel or the space-saver spare tire on the hub and screw at least two lug bolts finger-tight into opposite bolt holes
- 10 Screw in the remaining lug bolts. Tighten all the bolts snugly
- 11 Lower the jack and remove it from beneath the vehicle
- 12 Tighten the lug bolts in a diagonal pattern



- 13 If your wheels are equipped with full wheel covers\*, place the wheel cover with the valve opening over the valve (arrow). Use both hands to press the cover securely onto the rim
- 14 Check and correct the tire's inflation pressure at the earliest possibility. For vehicles with RDC (Tire Pressure Control)\*: After mounting the space-saver spare tire or correcting the inflation pressure, reactivate the system. Refer to page [89](#).

 Only use original BMW full wheel covers, otherwise, the trim piece may not fit securely. The full wheel cover may not be installed on the space-saver spare tire, since this could damage the cover. ◀

 The vehicle jack is designed for changing wheels only. Do not attempt to raise another vehicle model with it or to raise any load of any kind. To do so could cause accidents and personal injury.

To ensure continued safety, have the solid fit of the lug bolts [torque: 72 lbft (100 Nm)] checked using a calibrated torque wrench. ◀

When storing the wheel, take care to ensure that you do not damage the retaining pin in the spare tire recess.

If light-alloy wheels other than original BMW light-alloy wheels have been mounted, it may be necessary to use different lug bolts for those wheels.

Replace the defective tire as soon as possible and have the new wheel/tire balanced.

**Driving with the space-saver spare tire**

Drive cautiously. Do not exceed a speed of 45 mph (80 km/h).

You can anticipate changes in vehicle handling such as delayed braking response, longer braking distances and changes in self-steering properties when approaching stability limits.

The changes in handling characteristics will be even more pronounced in conjunction with winter tires.

 Only one space-saver spare tire may be mounted at one time. Re-install wheels and tires of the same size and specification as soon as possible. Maintain correct tire pressures. Refer to page 28. ◀

**Battery****Installation location**

The battery is located at the right-rear of the luggage compartment. Raise the luggage compartment floor panel (refer to page 40). Release the two fasteners plus an additional fastener in the upper-center side trim panel by turning a screwdriver or a coin 1/4-turn counter-clockwise. In order to remove the storage tray, slide the side trim panel slightly upward.

**Charge condition**

You can read the charge condition of the battery with the "Magic Eye"\* (= hydrometer):

- ▷ Green: adequate charge
- ▷ Black: not adequately charged. The battery must be recharged. Please contact your BMW center for additional information
- ▷ Yellow: replace the battery.

 The service life specified for the battery can be achieved only if it is always kept adequately charged. If the vehicle is primarily used for driving short distances, be sure to check the charge status often. ◀

# Battery

## Battery care

The battery is absolutely maintenance-free, that is, the original acid will normally last for the service life of the battery under temperate climatic conditions.

 For all questions regarding the battery, please consult your BMW center. Since the battery is absolutely maintenance-free, the following information is for your use only. ◀

## Symbols

You will find the following symbols on your vehicle battery. For your safety, please be cautious whenever you work with or near the battery.



Before handling the battery, please read the following information.



Wear eye protection. Do not allow particles containing battery acid or lead to come into contact with your eyes, your skin, or your clothing.



Battery acid is extremely corrosive. Wear eye protection and protective gloves. Do not tip the battery. Battery acid can leak from the ventilation openings.



Do not allow children to have access to batteries and battery acid.



Never allow sparks or open flame near the battery. Do not smoke in the vicinity of the battery. Avoid sparks from electrical cables or electrical equipment. Turn the key to position 0 in the steering lock when disconnecting or connecting the battery. Do not short-circuit the battery terminals. This creates a risk of injury from high-energy sparks.



A highly explosive gas is generated when the battery is charged.



If you happen to get acid in your eyes, rinse thoroughly for 15 minutes with clear water.

Consult a physician immediately. If you get acid spray on your skin or clothing, rinse with plenty of water. If acid is accidentally ingested, consult a physician immediately.



In order to protect the battery case from ultraviolet radiation, do not place it in direct sunlight. A drained battery can freeze. Store the battery in areas where temperature remains above freezing.

## Removal and installation

 Do not disconnect the battery when the engine is running. If you do so, the ensuing voltage surge will damage the vehicle's onboard electronics. Do not make any modifications in the wires to the positive terminal. If you do so, the protective function of the safety battery terminal is no longer ensured. Repair and disposal must be performed by trained technicians only. ◀

When removing the battery, disconnect the cable on the negative terminal first, then the cable on the positive terminal. Loosen the center adjusting screw on the battery retaining strap (use the screwdriver included with the onboard tool kit) and disconnect the strap.

When installing a battery, connect the positive terminal first, then connect the negative terminal.

 When installing a battery, be sure that it is mounted properly and that the retaining bracket is installed with the center adjustment screw, otherwise, the battery will not be adequately secured in case of an accident. ◀

## Charging the battery

Charge the battery in the vehicle only when the engine is not running.

 Before performing any work on the electrical system, be sure to unclamp the cable from the battery's negative terminal. Failure to do so can result in short-circuits, a fire or personal injury. ◀

If you plan to park the vehicle for longer than 4 weeks, disconnect the battery from the vehicle's electrical system by disconnecting the cable at the negative terminal. Then recharge the battery with an appropriate battery charger.

If you intend to store the vehicle for longer than 12 weeks, remove the battery, charge it and store it in a cool and dust-free room where there is no danger of freezing. During storage, have the battery recharged every 3 months. Also, recharge the battery before it is reinstalled. If this is not done, the battery will not be serviceable. Every time the battery is drained, especially over extended periods, its service life is reduced.



Return used batteries to a recycling point or your BMW center. Maintain the battery in an upright position for transport and storage. Secure the battery to prevent it from tilting during transport. ◀



Storage periods during which the battery is disconnected are not taken into consideration by the Service Interval Display for changing the brake fluid. For this reason, be sure that the brake fluid is changed every two years, regardless of the information displayed. Read and comply with the information on page 136 covering this subject. ◀



If an electrical accessory should fail, switch it off and check the fuse.

## In the glove compartment

- 1 Open the glove compartment and turn the two white quick-release fasteners outward. Spare fuses and plastic tweezers are located on the fuse holder
- 2 Use the plastic tweezers to remove the fuse for the accessory or equipment that has stopped working
- 3 Replace a burned-out fuse, recognizable from the melted metal strip, with a new fuse of the same color code or ampere rating.

A list of fuses, their respective ampere ratings and the equipment in their circuits are all indicated below the fuse holder.

To close the fuse holder, snap it into position at the top and turn the two fasteners inward.



Do not attempt to repair a burned-out fuse or replace it with a fuse with a different color or ampere rating. Doing this could cause a fire in the vehicle resulting from a circuit overload. ◀

If a fuse blows repeatedly, refer the problem to your BMW center for repair.



## Manual release

Pull the knob with the fuel pump symbol (arrow) on the right trim panel of the luggage compartment.



### Closing manually in the event of an electrical malfunction



Closing the convertible top manually is best done from the outside with the driver's door open and the driver's seat tilted forward. The rear seat should not be occupied while this operation is taking place. ◀

1 Remove the filler piece from between the rear seats. Remove the trim from the guide rod and tilt it forward. Press forcefully on the emergency lock operation (arrow). Doing this will unlock the mechanisms for the convertible top compartment lid after a short delay

2 With the luggage compartment lid closed, open the convertible top compartment lid all the way  
 3 Take hold of the convertible top by its lateral guide section and its front convertible top frame and lift it out (arrow). Position the rear convertible top bar vertically and close the convertible top compartment lid. Flip the rear convertible top bar downward

4 Using a screwdriver, lift out the cover panel in the center of the front convertible top frame  
 5 Put the dual-end Allen wrench (stored next to the emergency lock, see left column) into the hex slot (arrow)  
 6 Pull the front convertible top frame downward as far as possible. Continue the closing process by turning the Allen wrench to the left; keep on turning until the front convertible top frame is locked onto the windshield frame. The rear convertible top frame will be automatically pressed onto the convertible top compartment lid, and because of the pressure, will be sealed off when closed.

## Fully automatic convertible top\*



Please refer to your BMW center to have the defect corrected. ◀



In the event of an electrical defect, never open the convertible top by hand. The convertible top compartment lid cannot be locked and would open while driving. ◀

Do not use spray starter fluids to start the engine.

If the battery is drained, the engine can be started using two jumper cables and another vehicle's battery. Use only jumper cables with fully insulated handles on the terminal clamps.

 Do not touch the parts conducting electrical current while the engine is running. Failure to comply with this creates a risk of fatal injury. ◀

Carefully comply with the following instructions to avoid personal injury or damage to one or both vehicles:

- 1 Be sure that the battery on the support vehicle is also rated at 12 volts, and that the capacities of the two batteries (Ah) are roughly comparable (printed on casing)
- 2 Leave the drained battery connected to the vehicle's electrical system
- 3 Make sure that there is no contact between the bodywork of the two vehicles – short circuit risk!
- 4 Start by connecting the jumper cable from the positive terminal of the support vehicle to the positive terminal connector located in your BMW's engine compartment. The cover of the auxiliary terminal for jump-start-



ing is identified by a "+" sign. Refer to the illustration. Remove by pulling the tab (arrow 1)

- 5 Then connect the negative terminals. Attach the cable to either the support vehicle's negative battery terminal (-), or to a suitable ground on its engine or bodywork. Then connect the other end of the cable to a ground on the engine or on the bodywork of the vehicle that is to be started. There is a special nut provided for this on the BMW (arrow 2)

 Follow the same sequence for connecting the jumper cables when helping other vehicles. If you do not, there is the risk of injury if sparks are generated at the battery. ◀

- 6 Start the support vehicle's engine and let it run
- 7 Start the engine on the vehicle needing the jump-start, and allow it to run as usual. If the first start attempt is not successful, wait a few minutes before another attempt in order to allow the drained battery to recharge
- 8 Before disconnecting the jumper cables from your BMW, turn on the rear window defroster and set the blower to the highest speed; allow the engine to run approx. 10 seconds. This will prevent a voltage surge from the voltage regulator to the electrical accessories
- 9 Then disconnect the jumper cables in reverse sequence.

Depending on the reason for the malfunction, recharge the battery.



## Towing the vehicle



### Tow fitting

The screw-in tow fitting is stored in the onboard tool kit; be sure that it remains in the vehicle at all times. This fitting is designed for installation in the tow sockets located at the front and rear of the vehicle. It is intended for towing on paved road surfaces only. This fitting should not be used to pull a vehicle out of deep snow, mud, sand, etc. Always comply with all applicable towing laws and regulations.

### Access to tow sockets

Front:

Using a screwdriver, press out the cover panel on the top part of the recess.



Rear:

Using a screwdriver, press out the cover panel on the top part of the recess.



Screw the tow fittings in completely and tightly. If you do not, the threads could be damaged.

Do not tow the vehicle by any components of the running gear, or lash them down in any way. If you do, the components could be damaged, leading to possible accidents. ◀

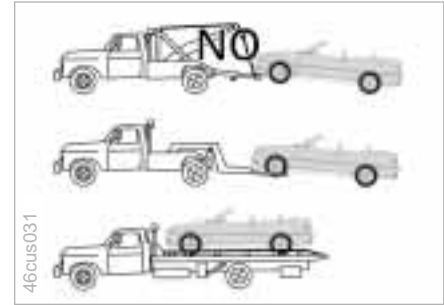

### Towing with a commercial tow truck

- ▷ Do not tow with sling-type equipment
- ▷ Use wheel lift or flat bed equipment
- ▷ Please comply with applicable state towing laws.



Never allow passengers to ride in a towed vehicle for any reason. Never attach tie-down hooks, chains, straps, or tow hooks to the tie rods, control arms, or any other part of the vehicle suspension. If you do so, severe damage will occur to these components. ◀





Adaptive Transmission Control (ATC) 172  
 Airbags 173  
 Dynamic Stability Control (DSC) 173  
 Radio reception 174  
 Safety belt tensioner 174  
 Interior rearview mirror with automatic dimmer 175  
 Rain sensor 176  
 Tire Pressure Control (RDC) 177  
 Self-diagnostics 178  
 Rollover protection system 179  
 Xenon lamps 179

Overview

Controls and features

Operation, care and maintenance

Owner service procedures

Advanced technology

Technical data

Index



For vehicles with automatic transmission\*, Adaptive Transmission Control (ATC) makes the optimum gear selection based on a number of factors. In this process, it considers your individual driving style as well as current driving conditions.

ATC recognizes your personal driving style from the positions and movements of the accelerator pedal, deceleration when braking, and lateral acceleration through curves. ATC makes the appropriate selection based on various shift characteristics, which range from comfort- to performance-oriented.

In order to include driving conditions in its calculations, ATC registers curves and both uphill and downhill gradients. For example, if you maintain speed through a curve, the transmission does not shift up.

On uphill gradients, it shifts up only when the engine speed increases in order to make more efficient use of power reserves. On downhill gradients, ATC shifts down when the speed of the vehicle increases and the driver must apply the brakes.



Deceleration sensors continuously monitor the acceleration forces acting upon the vehicle. If, as the result of a frontal collision, a deceleration is reached at which the protection of the safety belts alone is no longer adequate, the gas generators of the driver and passenger-front airbags are ignited. However, the passenger-side airbag is only triggered if an additional sensor has recognized that the passenger seat is occupied.

In the event of a side collision, the side airbags in the front are triggered if necessary.

The airbags located under the marked covers inflate and unfold in a matter of a few milliseconds. In this process, they tear through the designed separation points of the upholstered covers or press them out.

Because the inflation process must be virtually instantaneous, it is necessarily accompanied by a certain amount of ignition and inflation noise. The gas required to inflate the airbags is not dangerous, and the smoke associated with it dissipates.

The entire process is completed within fractions of a second.

Highly sensitive sensors monitor the wheel speeds, steering angle, lateral acceleration, brake pressure and the movement of the vehicle around its vertical axis.

If differences in the wheel speeds occur, the system counteracts the danger of wheelspin by reducing torque. If necessary, the system also responds with additional brake applications at the rear wheels.

In addition, DSC permanently monitors the vehicle's current operating condition and compares it with an ideal condition that is calculated from the sensor signals. If deviations from this occur (understeering or oversteering, for instance), DSC can stabilize the vehicle in fractions of a second by reducing engine output and with the assistance of braking intervention at individual wheels. As a result, most skids can be prevented from their very onset.

You may need some time to become accustomed to this system intervention. However, it provides optimum drive force and vehicle stability.

The braking intervention may be accompanied by sounds specific to the system.

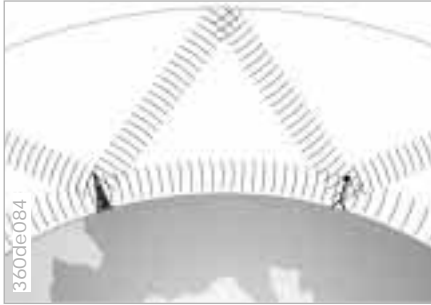

The AM frequency bands (medium-wave, long-wave and short-wave) make it possible to receive stations from a great distance, because the broadcast signals travel not only along the ground as surface waves, but also as atmospheric waves that are reflected from the ionosphere.

Frequency-modulation (FM) provides substantially better sound quality than the other frequencies. However, because FM transmissions rely on line-of-sight broadcast waves, their effective reception range is limited.

The limitations inherent to radio reception in a moving vehicle have been minimized by a number of innovative system designs:

The "Radio Data System" (RDS) makes sure that, for stations broadcasting on several frequencies, the radio automatically tunes to the frequency with the best reception quality.

With the Diversity Antenna system, several FM antennas are integrated within the convertible top compartment lid to provide three separate sources for receiving broadcast waves. An integral processor automatically selects the antenna with the best FM reception quality at any given time. The selection of the antenna takes place within milliseconds, and is therefore not noticed by the radio listener.



The safety belt tensioners respond to severe head-on collisions by tightening the belts to ensure that occupants remain firmly positioned in their seats. A gas-pressure system retracts the buckle assembly to tension the shoulder and lap belts within fractions of a second. This reduces the tendency to slide under the lap belt.

## Interior rearview mirror with automatic dimmer\*

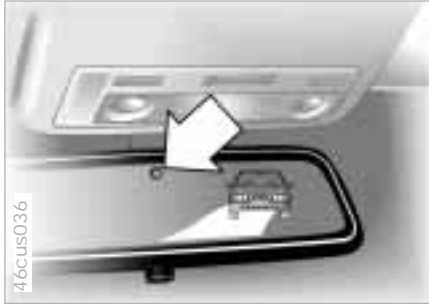

The semisolid reacts chemically to this electrical current, dimming the mirror through an infinitely-variable range (electrochromic technology).

As a result, it is no longer necessary to dim the mirror manually, and the driver can concentrate completely on traffic conditions.

The interior rearview mirror with automatic dimming feature reduces glare by adapting the intensity of the reflected images to correspond to levels of light registered by the unit's sensors. The mirror reverts to its undimmed setting as soon as the light source disappears. One light sensor is mounted on the front of the mirror housing. This sensor, the one that is directed forward, measures light intensity in the area ahead of the vehicle. The second sensor is integrated within the mirror's glass. The electronic control system compares the light intensity from front and rear. The difference provides the basic parameter used to modulate an electrical current and induce chemical changes in a semi-solid layer incorporated in the lens.

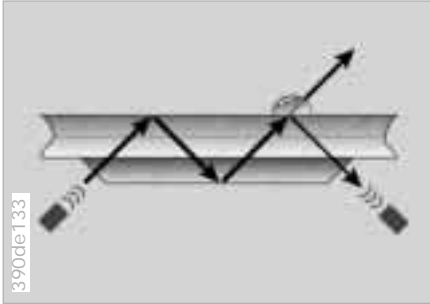

When the system is set to the "Intermittent" wiper speed, the wipers react immediately – if water is splashed onto the windshield by vehicles traveling ahead of you, for example. As a result, the rain sensor contributes to driving safety and comfort.

Depending on how wet the windshield is, the rain sensor controls the operation of the windshield wipers.

Infrared light is carried along the surface of the windshield in an optical conductor in such a manner that it is reflected completely when the windshield is dry. The quantity of reflected light is measured.

If there is moisture on the glass, the amount of light reflected is reduced since the infrared light at the surface of the windshield can escape. The quantity of reflected light is thus a means of gauging the degree of wetness on the windshield.





There is an antenna located right near every wheel in the vehicle body. Each antenna picks up signals from its respective wheel. A central electronics system evaluates all four signals and forwards any changes. The RDC provides an important contribution to driving safety.

This system regularly checks tire pressure and monitors all four tires even while driving, so you don't have to.

Behind the valve stem in every wheel, there is an electronic chip that is designed for severe-duty applications and long service life. It contains a pressure sensor, a transmitter and a battery. The pressure is measured in extremely short time intervals and then transmitted by a radio signal. If an irregularity is detected, the transmission rate is increased.



All of the important electrical and electronic systems in the vehicle are tested regularly and automatically; the driver does not have to perform any extra operations or adjustments.

The indicator lamps come on briefly when the ignition is switched on.

While you are driving, the functional status of the actuator motors (for the windshield wipers, power windows, seats, etc.) is constantly analyzed by current measurements in their relays.

In the same manner, the electrical resistance of the airbag ignition generators and all of the remaining airbag components is measured at all times. Any fault in this system would be detected immediately by a current fluctuation that would necessarily accompany it. The fault would be indicated immediately by the airbag warning lamp.

Even after you shut off the engine, the overall functional status of your vehicle is being monitored. For example, all of the flaps for the heating and ventilation system travel to the nearest limit position. This action ensures that in any case, the defrosting function will remain intact, even if a malfunction in the automatic climate control should occur during the night while the vehicle is parked.

A calibration cycle runs every tenth time the engine is shut off. During this cycle, the actuator motors of all the heating and ventilation flaps travel to their limit stops in both directions. The limit positions and the return travel paths are checked in this manner in order to ensure that appropriate adjustments for the operating elements can be made at any time.

The sounds the automatic climate control makes as it carries out its self-diagnostics are noticeable because of the noise that the ventilation flaps make after the ignition has been switched off. All of the other self-diagnostics functions operate silently in the background.

Any possible defects detected during these self-diagnostics can be read out by your BMW center and quickly corrected during the vehicle's next regularly scheduled maintenance.

The rollover protection system offers additional protection apart from the airbags and safety belts. The system has highly sensitive sensors that react immediately upon detecting an unstable vehicle condition, i.e. when the vehicle is tilted to a critical degree, or if the wheels are not making proper ground contact. In this kind of situation, the protective bar in each rear head restraint is triggered.

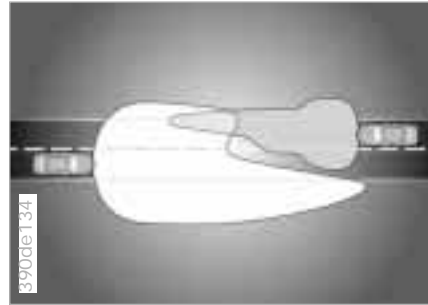

Xenon lamps illuminate the side and front areas of the vehicle with significantly more brightness and uniformity than the traditional halogen lamp.

In a xenon lamp, an electric arc replaces the filament in order to generate intense illumination. A gas mixture in a quartz glass tube with metal vapor is ignited by a high electric voltage. The arc that is generated is then sustained by a lower voltage. When the lamp is turned on there is a brief warm-up period. Maximum brightness is attained in approx. 15 seconds.

Xenon lamps provide significantly improved visibility, especially during adverse weather and poor driving conditions e.g. driving at night in heavy rain or through road repair areas where there are no lane markers.

Vehicles with xenon lamps are equipped with automatic headlamp range control. As a result, the highway is always optimally lighted, regardless of road conditions, and drivers in oncoming traffic are not blinded.

Xenon lamps make a significant contribution to highway safety since pedestrians and other highway users, bicyclists and motorcyclists in the right lane, are more easily detected.

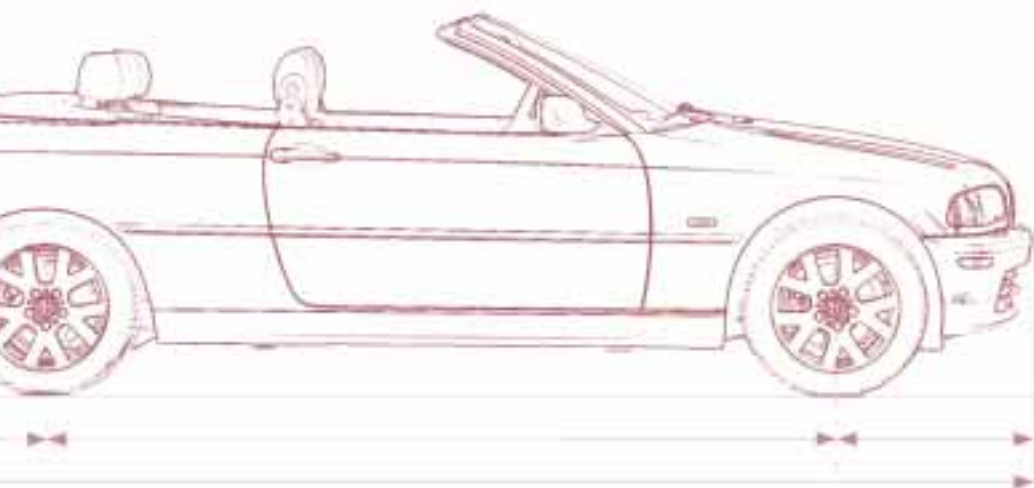

Engine data [182](#)  
Dimensions [183](#)  
Weights [184](#)  
Capacities [185](#)  
Electrical system [186](#)  
Drive belts [186](#)

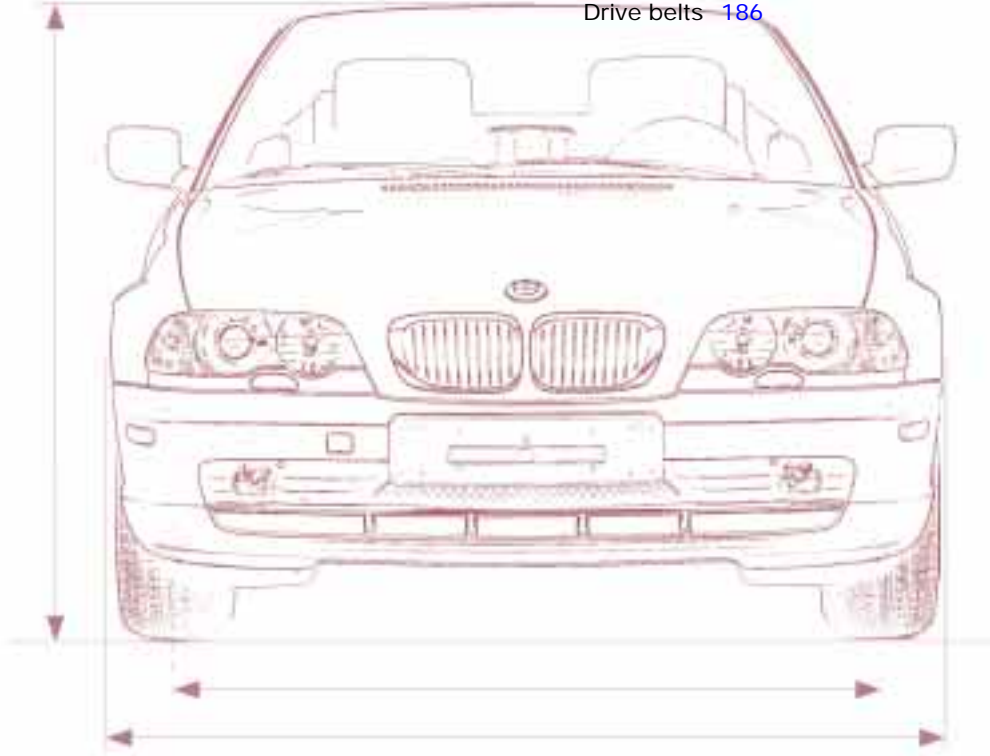

[Overview](#)

[Controls and features](#)

[Operation, care  
and maintenance](#)

[Owner service procedures](#)

[Advanced technology](#)

[Technical data](#)

[Index](#)

Overview

Controls

Car care

Repairs

Technology

Data

Index

182 **Engine data**

		BMW 323Ci
Displacement	cu. in. (cm <sup>3</sup> )	152.2 (2,494)
Number of cylinders		6
Maximum output at engine speed	hp (kW) rpm	170 (127) 5,500
Maximum torque at engine speed	lb.ft (Nm) rpm	181 (245) 3,500
Compression ratio	$\epsilon$	10.5
Stroke	in (mm)	2.95 (75)
Bore	in (mm)	3.31 (84)
Fuel-injection system		Digital electronic engine-management system

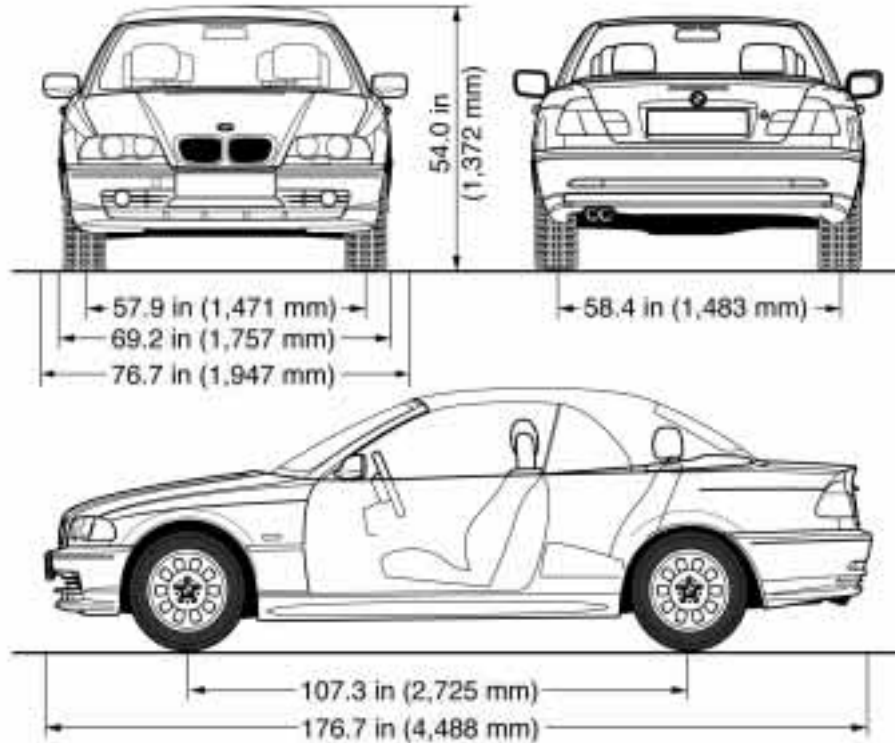

Minimum turning circle dia.: 34.4 feet (10.5 m).

---

 BMW 323Ci
 

---

Curb weight (with one person, ready for operation, full tank of fuel, options not included)

with manual transmission	lbs. (kg)	3,560 (1,615)
with automatic transmission*	lbs. (kg)	3,627 (1,645)

---

Approved gross vehicle weight

with manual transmission	lbs. (kg)	4,442 (2,015)
with automatic transmission*	lbs. (kg)	4,508 (2,045)

---

Approved front axle weight

lbs. (kg) 2,094 (950)

---

Approved rear axle weight

lbs. (kg) 2,469 (1,120)

---

Permissible roof load for the hardtop\*

lbs. (kg) 165 (75)

---

Luggage compartment capacity

cu ft (l) 9.2 (260)

with raised convertible top compartment

cu ft (l) 10.6 (300)

---

Permitted axle loads and permitted total vehicle weight may not be exceeded.



			Notes
Fuel tank reserve	gal. (liters) gal. (liters)	approx. 16.6 (approx. 63) approx. 2.1 (approx. 8)	Fuel specification: page <a href="#">27</a>
Windshield washer system/ Headlamp washer system*	quarts (liters)	approx. 5.6 (approx. 5.3)	For details: page <a href="#">132</a>
Cooling system including heater circuit	quarts (liters)	approx. 8.9 (approx. 8.4)	For details: page <a href="#">135</a>
Engine oil filter change	quarts (liters)	approx. 6.9 (approx. 6.5)	BMW High Performance Synthetic Oil For further information, refer to page <a href="#">134</a>
Manual and automatic* transmission and differential		-	Lifetime fluid, no fluid change required

## 186 Electrical system

### Battery

12 V, 80 Ah

### Spark plugs

NGK BKR 6 EQUIP  
Bosch FGR 7 DQP

## Drive belts

Water pump – AC alternator – Power steering

Drive belt 6 PK x 1538

A/C compressor

Drive belt 5 PK x 863



You can obtain Original BMW Parts and Accessories, as well as professional advice from your BMW center. ◀



A B C

P Q R

Everything from A to Z 190

Owner service procedures 196

Overview

Controls and features

Operation, care  
and maintenance

Owner service procedures

Advanced technology

Technical data

Index

Overview

Controls

Car care

Repairs

Technology

Data

Index

# Everything from A to Z

## A

ABS (Antilock Brake System) 22, 114  
Accessories 6  
Activated charcoal filter 98  
Adaptive Transmission Control (ATC) 74, 172  
Adding engine oil 133  
Adding washer fluid 132, 185  
Adjust seats 53  
Adjust the temperature 96  
Adjusting the steering wheel 58  
Air distribution 96  
Air outlets 94  
Air pressure 123  
Air supply 97  
Airbags 21, 63, 146, 173  
sitting properly with 64  
Alarm system 42  
Antenna 120  
Antenna, Diversity 174  
Antifreeze 135  
Antifreeze, radiator 118  
Antilock Brake System (ABS) 22, 114  
Anti-theft alarm system 42  
Aquaplaning 113, 123  
Armrest 102  
Ashtray  
front 103  
rear 104

Assisted rear entry 56  
ATC (Adaptive Transmission Control) 74, 172  
Attaching vehicle vacuum cleaner 104  
AUC (Automatic recirculated air control) 97  
Automatic car washes 139  
Automatic climate control 94  
remove window condensation 97  
Automatic cruise control 80  
Automatic dimming, interior rearview mirror 59  
Automatic recirculated air control (AUC) 97  
Automatic transmission with Steptronic 22, 74  
Automatic windshield washer 78  
Average consumption 86  
Average speed 86  
Avoiding unwanted alarm 43  
Axle loads 184

## B

Backrest  
release 56  
Backup lamps 73  
bulb replacement 155

## Battery 162, 186

capacity 186  
charge 164  
charge current 20  
drained 168  
removal and installation 164  
Belts 61  
Blower 97  
BMW High Performance Synthetic Oils 134  
BMW Sports Seat 55  
BMW Universal Transmitter 100  
Bore 182  
Brake fluid 136  
Brake hydraulic system 20  
Brake lamps  
bulb replacement 155  
Brake pads 22  
Brakes 116  
malfunctions 117  
Break-in procedure 112  
Breaking in the vehicle 112  
Bulb replacement 152

## C

Capacities 185  
Car Memory 60  
Car radio 120  
refer also to the separate Owner's Manual

Car radio  
reception 120, 174  
Car wash 139  
Care  
convertible top 144  
exterior 140  
interior 141  
Care of upholstery 142  
Cargo loading 106  
Caring for the vehicle finish 140  
Caring for wool velour 142  
Cassette operation, refer to the Radio Owner's Manual  
Catalytic converter 113  
CBC (Cornering Brake Control) 21, 115  
CD operation, refer to the Radio Owner's Manual  
Cellular phone 103, 120  
refer also to the separate Owner's Manual  
Center armrest 102  
Center brake lamp 157  
Central locking system 34  
key 38  
Changing tires 159  
Check Control 84  
Child restraint  
systems 61, 66, 67  
installation 67  
Child's seat 61, 66

- Cigarette lighter 104
  - Clock 84
  - Cockpit 16
  - Code, refer to the Radio
    - Owner's Manual
  - Coin box, cup holder 103
  - Combination switch 77
  - Compression 182
  - Computer 85
  - Configure settings 60
  - Consumption 86
  - Consumption display 83
  - Convertible top
    - care 144
    - electrical defect 166
  - Convertible top
    - compartment panel 41
  - Convertible top operation,
    - fully automatic convertible top 49
  - Coolant 118, 135, 185
    - antifreeze 118
  - Coolant temperature
    - gauge 83
  - Cooling system 185
  - Cornering Brake Control (CBC) 21, 115
  - Cruise control 80
  - Cruising range 86
  - Curb weight 184
  - Current check indicator 20
- D**
- Dash lighting 91
  - Dashboard 16
  - Data
    - dimensions 183
    - engine 182
    - technical 182
    - weights 184
  - Daytime-driving lamp
    - switch 91
  - Defrost setting 97
  - Defrosting the
    - windows 97, 98
  - Digital clock 84
  - Dimensions 183
  - Dipstick, engine oil 133
  - Disc brakes 116
  - Displacement 182
  - Display lighting 91
  - Displays 18
  - Distance warning 87
  - Diversity Antenna 174
  - Door key 32
  - Door locks, care 118
  - Doors
    - emergency actuation 34
    - remote control 35
    - unlocking and locking 34
  - Drive belts 186
  - Driving hints 113
  - Driving in winter 118
- E**
- Driving lamps 91
  - DSC (Dynamic Stability Control) 22, 88, 173
- F**
- Electric power windows 44
  - Electrical accessories,
    - failure 165
  - Electrical system 186
  - Electronic vehicle
    - immobilizer 33
  - Elements of operation 16
  - Emergency actuation
    - doors 34
    - fuel filler door 165
    - fully automatic convertible top 166
  - Emergency closure 166
  - Energy Control 82
  - Engine compartment 130
  - Engine coolant 135, 185
  - Engine data 182
  - Engine oil
    - capacity 185
    - consumption 133
    - pressure 20
    - quality 134
    - specifications 134
    - viscosity 134
  - Engine oil level 21
    - check 133
  - Engine speed 182
  - Engine, starting 70
  - Entry to the rear 56
  - Exterior mirrors 58
  - Eyes 169
- F**
- Failure messages 84
  - Fault displays 84
  - Fault, ABS 115
  - Filler cap cover 26
  - Filling capacities 185
  - Filling the washer
    - reservoir 185
  - First-aid kit 25
  - Flashlight 99
  - Flat tire 123, 159
  - Fog lamps 92
    - bulb replacement 155
  - "Follow-Me-Home"
    - lamps 91
  - Footbrake 116
  - Footwell lamps 92
    - bulb replacement 158
  - Front seat adjustment 53
  - Frost protection,
    - radiator 135
  - Fuel 27
    - gauge 83
    - preparation 182
    - quality 27
  - Fuel consumption 86

# Everything from A to Z

Fuel consumption  
  display 83  
Fuel reserve indicator  
  lamp 83  
Fuel tank capacity 185  
Fuel tank gauge 83  
Fully automatic convertible  
  top  
  actuation 49  
  emergency closure 166  
  one-touch operation 34  
Functional status 178  
Fuses 165

## G

Garage-door opener 100  
Gasoline 27  
Gasoline gauge 83  
Glove compartment 99  
Glove compartment lamp  
  bulb replacement 158  
Grills 94  
Gross vehicle weight 184

## H

Handbrake 72  
Hands-free system 103  
Hanging the luggage  
  compartment floor up by  
  the hook 40  
Hardtop 121  
Hazard warning flashers 25

Hazard warning triangle 25  
Head restraints 54  
Headlamp covers,  
  care 139, 153  
Headlamp flasher 92  
Headlamp washer  
  system 79, 132, 185  
Heated seats 99  
Heater and ventilation 94  
Heavy loads 106  
Height 183  
High beams 23, 77, 92  
  bulb replacement 153  
Hood release 129  
Horn 17  
Hub cap 160

## I

Ice warning 85  
Identification, tires 126  
Ignition key 32  
Ignition lock 70  
Increasing the space in the  
  luggage compartment 41  
Indicator lamps 20  
Inflated pressure 27, 123  
Inflation pressure  
  monitoring 89, 177  
INSPECTION 83  
Instrument cluster 18  
Instrument lighting 91

Interaxle tire rotation 125  
Interface socket for On-  
  Board Diagnostics 149  
Interference  
  cellular phones 120  
Interior lamps 37, 92  
  bulb replacement 157  
  remote control 37  
Interior rearview mirror,  
  automatic dimming  
  feature 59, 175  
Interlock 70  
Intermittent wipe 77  
ISOFIX Attachment of the  
  child seat 62

## J

Jack 159  
Jets 94  
Jump starting 168

## K

Key 32  
Key Memory 60  
Key with remote control 32

## L

"Lamps on" warning 91  
Lashing eyes 107  
Leather care 143  
Length 183

License plate lamp  
  bulb replacement 157  
Light switch 91  
Light-alloy wheels 128  
Lighter 104  
Load-securing devices 107  
Low beams 91  
  bulb replacement 153  
Lug bolts 160  
Luggage compartment 39  
  capacity 184  
  emergency release 39  
  floor panel 41  
  remote control 37  
Luggage compartment  
  lamps  
  bulb replacement 158  
Luggage compartment  
  lid 39  
  emergency release 39  
Luggage compartment  
  lighting 39  
Luggage rack 108  
Lumbar support 56

## M

M+S tires 127  
Maintenance 83, 138  
Malfunction displays 84  
Manual convertible top  
  operation in the event of an  
  electrical malfunction 166



- Manual transmission [73](#)
  - Manually controlled
    - recirculated-air [97](#)
  - Memory [57](#)
  - MFL (Multifunction steering wheel) [24](#)
  - Mirror memory [57](#)
  - Mirrors [58](#)
  - Mobile phones [120](#)
  - Modifications,
    - technical [6](#), [148](#)
  - Multifunction steering wheel (MFL) [24](#)
- N**
- Navigation system, refer to the Radio Owner's Manual
- O**
- OBD interface socket [149](#)
  - Odometer [82](#)
  - Oil
    - additives [133](#)
    - capacity [185](#)
    - consumption [133](#)
    - dipstick [133](#)
    - quality [134](#)
    - specifications [134](#)
    - viscosity [134](#)
  - Oil change intervals, see the Service and Warranty Information Booklet
  - Oil filter change [185](#)
  - Oil level
    - check [133](#)
    - Indicator lamp [20](#)
  - Oil pressure, indicator lamp [20](#)
  - OILSERVICE [83](#)
  - Onboard computer [85](#)
    - also refer to separate Owner's Manual
  - Onboard tool kit [152](#)
  - Opening and closing
    - from inside [38](#)
    - from outside [34](#)
  - Operating the convertible top
    - manual convertible top [45](#)
  - Outlets, ventilation [94](#)
  - Outside temperature display [85](#)
- P**
- Paint blemishes [140](#)
  - Paint, care [140](#)
  - Paintwork, minor repairs [141](#)
  - Paintwork, waxing [141](#)
  - Park Distance Control (PDC) [87](#)
  - Parking brake [72](#)
  - Parking help [87](#)
  - Parking lamps [92](#)
  - Parking, winter [119](#)
  - PDC (Park Distance Control) [87](#)
  - Performance [182](#)
  - Pocket lamp [99](#)
  - Pollen [98](#)
  - Power seats [53](#)
  - Power steering [120](#)
  - Power windows [44](#)
  - Pressure monitoring,
    - tires [89](#), [177](#)
  - Pressure, tires [27](#), [123](#)
- R**
- Radiator [185](#)
  - Radio Data System (RDS) [174](#)
  - Radio reception [120](#), [174](#)
  - Radio, refer to the separate Owner's Manual
  - Rain sensor [78](#), [176](#)
  - RDC (Tire Pressure Control) [89](#), [177](#)
  - RDS (Radio Data System) [174](#)
  - Reading lamps [93](#)
  - Rear lamp [155](#)
  - Rear window
    - defroster [79](#), [98](#)
  - Rearview mirror [58](#), [59](#)
  - Reclining seat [53](#)
  - Refueling [26](#)
  - Remote control [35](#)
  - Remote control key [32](#)
  - Remove condensation,
    - windows [97](#)
  - Replacement key [32](#)
  - Reporting safety defects [7](#)
  - Restraint system [61](#), [66](#)
  - Reverse [17](#), [73](#)
  - Rollover protection
    - system [68](#), [179](#)
    - lowering [68](#)
  - Roof load capacity [184](#)
  - Roof luggage rack [108](#)
  - Roof-carrier assembly [121](#)
  - Rubber parts [118](#)
- S**
- Safety belt tensioners [174](#)
  - Safety belts [61](#)
  - Safety buttons [38](#)
  - Seat heating [99](#)
  - Seat memory [57](#)
  - Seat-integrated safety belt system [56](#)
  - Seats
    - sitting properly [53](#), [64](#)
  - Securing cargo [107](#)
  - Securing loads [107](#)
  - Selector lever, automatic transmission [74](#)
  - Self-defrosting mirrors [59](#)
  - Self-diagnostics [178](#)

# Everything from A to Z

Service and Warranty Information Booklet (US models) [138](#)

Service Interval Display [83](#), [138](#)

Shiftlock [74](#)

Side airbags [63](#)

Side lamps [91](#)  
bulb replacement [154](#)

Sitting properly [53](#)  
using airbags [64](#)

Ski bag [105](#)

Skid control [119](#)

Slippery roads [118](#)

Snow chains [118](#), [128](#)

Socket [104](#)

Space-saver spare tire [159](#)

Spare key [32](#)

Spare tire [159](#)

Spark plugs [186](#)

Speaker [103](#)

Speedometer [18](#)

Starting [70](#)

Starting problems [113](#), [168](#)

Steel wheels [128](#)

Steering [120](#)

Steering wheel lock [70](#)

Steptronic [74](#)

Stopping the vehicle [71](#)

Storage compartments [102](#)

Storing your vehicle [147](#)

Stroke [182](#)

Summer tires [126](#)

Switching off the engine [71](#)

Symbols [4](#), [163](#)

Synthetic oils [134](#)

## T

Tachometer [82](#)

Tail lamps [155](#)  
bulb replacement [155](#)

Tank capacity [185](#)

Tank cover  
unlock in case of electrical fault [165](#)

Technical data [182](#)

Technical modifications [6](#), [148](#)

Telephone  
refer to the separate Owner's Manual

Telephone hookup [103](#)

Temperature display  
outside temperature [85](#)

Temperature gauge  
engine coolant [83](#)

Temperature layering [98](#)

Tether anchorage for child restraint [66](#)

Third brake lamp [157](#)

Tilt alarm [37](#)  
remote control [37](#)

Tilt sensor alarm system [43](#)

Tire codes [126](#)

Tire damages [123](#)

Tire inflation  
pressure [27](#), [123](#)

Tire Pressure Control (RDC) [89](#), [177](#)

Tire pressure  
monitoring [89](#), [177](#)

Tire pressure, checking [27](#)

Tire replacement [124](#), [125](#)

Tire specifications [128](#)

Tire tread [123](#)

Tools [152](#)

Torque [182](#)

Tow fittings [169](#)

Towing [169](#)

Track [183](#)

Traction Control System  
refer to DSC [88](#)

Transmission [73](#)

Tread depth, tires [123](#)

Trip odometer [82](#)

Trunk [39](#)  
locking separately [39](#)

Trunk lid, refer to luggage compartment lid [39](#)

Turn signal indicator [23](#), [77](#)

Turn signals  
bulb replacement [154](#)

Turning radius [183](#)

Two-way radios [120](#)

## U

Uniform Tire Quality Grading [124](#)

Universal Transmitter [100](#)

Used batteries [164](#)

## V

Vehicle  
battery [162](#), [186](#)

identification [137](#)

immobilizer [33](#)

painting [140](#)

starting [70](#)

storage [147](#)

weight [184](#)

Vehicle care  
exterior [140](#)  
interior [141](#)

Vehicle Identification Number (VIN) [137](#)

Ventilation [94](#)

draft-free [98](#)

Vinyl upholstery, care [142](#)

Visors [59](#)

## W

Warning lamp "Please fasten safety belts" [21](#)

Warning lamps [20](#)

Warning messages [84](#)

Warranty and Service Guide (Canadian models) [138](#)

Washer reservoir, filling [132](#)

Washing your car [139](#)

Water on roadways  
deep water [113](#)

- Waxing, paintwork [141](#)
- Weights [184](#)
- Wheel lug wrench [159](#)
- Wheel rims [126](#)
- Wheelbase [183](#)
- Wheels and tires [126](#), [128](#)
- Width [183](#)
- Wind deflector [51](#)
- Windows
  - one-touch operation [34](#)
- Windshield washer nozzle
  - adjustment [132](#)
- Windshield washer reservoir,
  - filling [132](#), [185](#)
- Windshield wiper [77](#)
  - blade replacement [152](#)
- Winter operation [118](#)
- Winter tires [126](#), [127](#)
- Wiper system [77](#)
- Work in the engine
  - compartment [129](#)

## X

- Xenon lamp [153](#), [179](#)

# Owner service procedures

## A

- Adding brake fluid 136
- Adding engine coolant 136
- Adding engine oil 133
- Avoiding a false alarm 43
- Avoiding unwanted alarm 43

## B

- Backup lamps
  - bulb replacement 155
- Battery
  - add distilled water 163
  - charging 164
- Brake lamps
  - bulb replacement 155
- Brakes, brake faults 117

## C

- Changing the tire 159
- Check Control 84
- Checking engine oil level 133
- Checking tire pressure 27

## D

- Defrosting the windows 97
- Difficult steering 120
- Doors
  - emergency actuation 34

## E

- Electrical accessories, failure 165
- Electrical failure
  - fuel filler door 165
- Emergency actuation
  - doors 34
  - fully automatic convertible top 166
- Emergency release
  - fuel filler door 165
- Engine oil
  - add 133
  - quality 134
  - specifications 134
  - viscosity 134
- Eyes 169

## F

- Failure messages 84
- Fault displays 84
- First-aid kit 25
- Flat tire 159
- Fog lamps
  - bulb replacement 155
- Footwell lamps
  - bulb replacement 158
- Fuel filler door
  - manual release after electrical fault 165
- Fuses, replacing 165

## G

- Glove compartment lamp
  - bulb replacement 158

## H

- Hazard warning flashers 25
- Hazard warning triangle 25
- Headlamp cover, care 153
- High beams
  - bulb replacement 153

## I

- Indicator lamps 20
- Inflation pressure 27, 123
- Interior lights
  - bulb replacement 157

## J

- Jack 159

## L

- License plate lamp
  - bulb replacement 157
- Low beams
  - bulb replacement 153
- Luggage compartment
  - emergency release 39
- Luggage compartment lamps
  - bulb replacement 158
- Luggage compartment lid
  - emergency release 39

## M

- Maintenance 138
- Malfunction displays 84

## O

- Oil
  - quality 134
  - specifications 134
  - viscosity 134
- Onboard tool kit 152

## P

- Parking lamps
  - bulb replacement 154
- Pressure, tires 27

## R

- Releasing the hood 129
- Removing condensation from the windows 97
- Replace windshield wiper blades 152
- Replacement key 32
- Replacing lamp bulbs 152
- Return used batteries 164
- Rollover protection system
  - lowering 68

## S

- Space-saver spare tire 159
- Spare key 32
- Spare tire 159

# Owner service procedures

Starting problems [71](#), [113](#)

Switching off the interior  
motion sensor [43](#)

Switching off the tilt sensor  
alarm system [43](#)

## T

Tail lamps [155](#)  
bulb replacement [155](#)

Tire damage [123](#)

Tire rotation [159](#)

Tools [152](#)

Tow fittings [169](#)

Towing [169](#)

Turn signal indicator  
bulb replacement [154](#)

## U

Use of antifreeze,  
radiator [136](#)

## W

Warning lamps [20](#)

Warning messages [84](#)

Washer fluid, adding [132](#)

Washer nozzles,  
adjusting [132](#)

Wheel lug wrench [159](#)

Working in the engine  
compartment [129](#)

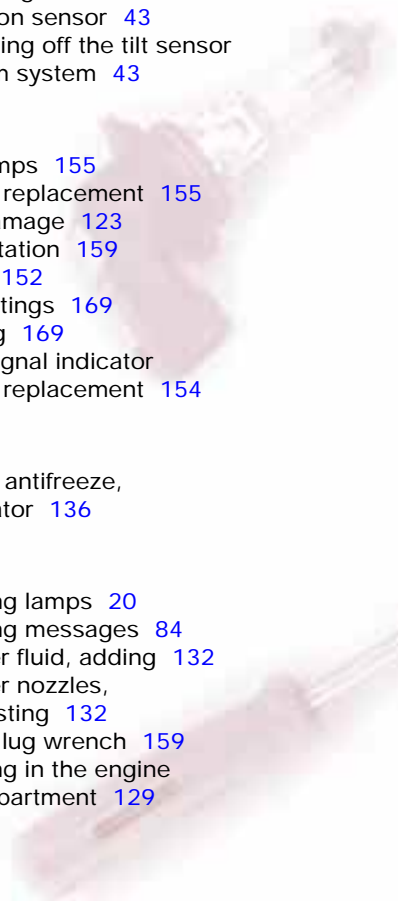

## Refueling

So that you will have important specifications available when you stop to refuel, we recommend that you supplement this table with data which apply to your vehicle.

### Fuel

Designation	
AKI: minimum	
AKI: for rated performance	
AKI: for enhanced performance	

### Engine oil

Quality	
---------	--

The space between the two marks on the dipstick corresponds to approx. 1.1 US quarts (1 liter).

Tire inflation pressure	Summer		Winter	
	Front	Rear	Front	Rear
2 persons				
4 persons plus luggage				

**We wish you an enjoyable  
driving experience.**



**The Ultimate Driving Machine**