

8310 Tank Gate Interface

The 8310 scans up to 50 tank gauges or transmitters (via Mark/Space communications), including Varec's 1800, 1900, 2900, 2910 and 4000 Float & Tape Transmitters

DVR Firmware Version: MSTG1_11

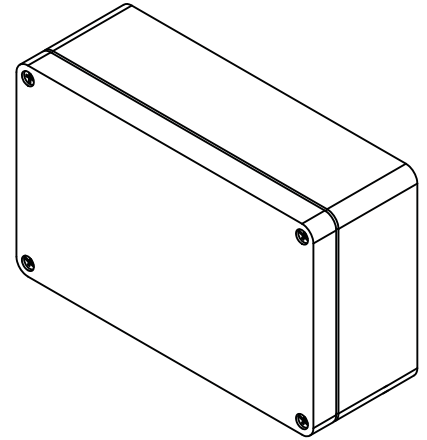

Copyright

All rights reserved. Printed in the United States of America.

Except as permitted under the United States Copyright Act of 1976, no part of this publication may be reproduced, stored in a retrieval system or transmitted in any form or by any means – electronic, mechanical, photocopying, recording, or otherwise – without the prior written permission of the Publisher:

Varec, Inc.
5834 Peachtree Corners East
Norcross (Atlanta), Georgia 30092
Phone: (770) 447-9202
Fax: (770) 662-8939

Trademarks Acknowledged

Varec, Inc. recognizes all other trademarks. Trademarks of other products mentioned in this manual are held by the companies producing them.

FuelsManager® and Varec® are registered trademarks of Varec, Inc.

Acrobat Reader® is a registered trademark of Adobe Systems Incorporated.

MODBUS® is a registered trademark of Modicon, Inc.

All other product and service names mentioned are the trademarks of their respective companies.

Disclaimer of Warranties

The contract between the Seller and the Buyer states the entire obligation of the Seller. The contents of this instruction manual shall not become part of or modify any prior or existing agreement, commitment, or relationship between the Seller and Buyer. There are no express or implied warranties set out in this instruction manual. The only warranties that apply are those in the existing contract between the Seller and Buyer.

The 8300 TGI has not been tested by Varec under all possible operational conditions, and Varec may not have all the data relative to your application. The information in this instruction manual is not all inclusive and does not and cannot take into account all unique situations. Consequently, the user should review this product literature in view of his or her application. If you have any further questions, please contact Varec for assistance.

Limitations of Seller's Liability

In the event that a court holds that this instruction manual created some new warranties, Seller's liability shall be limited to repair or replacement under the standard warranty clause. In no case shall the Seller's liability exceed that stated as Limitations of Remedy in the contract between the Seller and Buyer.

Use of parts that are not manufactured or supplied by Varec voids any warranty and relieves Varec of any obligation to service the product under warranty. Varec recommends the use of only Varec manufactured or supplied parts to maintain or service the 8300 TGI.

Terms of Use

The information provided in this document is provided "as is" without warranty of any kind. Varec, Inc. disclaim all warranties, either express or implied, including the warranties of merchantability and fitness for a particular purpose. In no event shall Varec, Inc. or its suppliers be liable for any damages whatsoever including direct, indirect, incidental, consequential, loss of business profits or special damages, even if Varec, Inc. or its suppliers have been advised of the possibility of such damages.

This manual is solely intended to describe product installation and functions and should not be used for any other purpose. It is subject to change without prior notice. This manual was prepared with the highest degree of care. However, should you find any errors or have any questions, contact one of our service offices or your local sales agent.

Safety Precaution Definitions

Caution! Damage to equipment may result if this precaution is disregarded.

Warning! Direct injury to personnel or damage to equipment which can cause injury to personnel may result if this precaution is not followed.

Safety Precautions

Read this manual carefully and make sure you understand its contents before using this product. Follow all instructions and safety guidelines presented in this manual when using this product. If the user does not follow these instructions properly, Varec cannot guarantee the safety of the system.

Note Comply with all applicable regulations, codes, and standards. For safety precautions, the user should refer to the appropriate industry or military standards.

Caution! Electrical Hazard! Read and understand static and lightning electrical protection and grounding described in API 2003. Make certain that the installation, operation, and maintenance conforms with the practice set forth therein.

Warning! Striking the product with a metal object could cause a spark to occur. When removing or replacing the product in flammable or hazardous liquid storage areas, take necessary measures to protect it from impact.

Warning! Sparks or static charge could cause fire or explosion! Mechanical connections, worker activity and worker clothing may accumulate electrostatic charges. Care should be used in flammable environments to avoid the hazard.

Contents

1	Overview	1
1.1	Versions	1
1.2	Features	1
1.3	Applications	2
1.4	Specifications	2
1.4.1	System Design	2
1.4.2	Software Functionality	2
1.4.3	Host Communication	2
1.4.4	Modbus Functionality	2
1.4.5	Power Supply	2
1.4.6	Power consumption	2
1.4.7	Surge protection	3
1.4.8	Operating temperature	3
1.4.9	Humidity	3
1.4.10	Storage temperature	3
1.4.11	Mechanical Construction	3
2	Hardware	5
2.1	Hardware Block Diagram	5
2.2	Motherboard Description	5
2.2.1	Power Supply	7
2.2.2	Switches and Indicators	9
2.2.3	Communications	10
3	8210 Varec Mark/Space Communications Interface Module	15
3.1	Features	15
3.1.1	Description	15
3.1.2	ID DIP Switch (SW1)	16
3.1.4	External Power Connector (+48V) (J2)	17
3.1.5	Surge/Shield Ground Connector (J4)	17
3.1.6	Field Wiring terminal block (J3)	17
4	Software Description	21
4.1	Software Features	21
4.1.1	Real-Time / Multitasking Executive	21
4.1.2	Real-Time Clock	21
4.1.3	Automatic Fault Recovery	21
4.1.4	Communications	22
4.1.5	Protocols	22
4.1.6	Data Scanning Task	22
4.1.7	Database Manager	22

4.1.8 System Tasks	23
4.1.9 Tank Gate Interface Software Blocks	23
4.2 Database Organization	23
4.2.1 Point Format	23
4.2.2 Parameter Description	23
4.3 Gathering Point Data	25
4.3.1 Standard Request-Response Format	25
4.3.2 Change of State Format	25
4.3.3 Change of State-Related Parameters.	26
4.3.4 Modbus Communications	26
4.3.5 Fixed Modbus Map	28
4.3.6 GWBLK method	28
4.4 Common Software Blocks.	31
4.4.1 Clock (CLK)	31
4.4.2 Communications (COM)	31
4.4.3 Floating Point Register (FPREG).	33
4.4.4 Emulator (EMU).	33
4.4.5 EMU Gateway (EMUGW)	35
4.4.6 Gateway Block (GWBLK)	36
4.4.7 Integer Register (IREG)	38
4.4.8 Modbus Gateway (MODGW)	38
4.4.9 Scaler Point (SCALER)	40
4.4.10 System Information (SYS).	41
5 Varc Mark/Space Software Blocks	43
5.1 Gauging Systems Inc. Model 2000 Mark/Space Interface (GS2000)	45
5.1.1 Parameters	45
Application	46
5.2 Varc Mark Space Servo Gauge (MSSTG)	49
5.2.1 ParametersW	49
5.2.2 Application	51
5.3 Mark Space Scanner (MSSCAN)	53
5.3.1 Parameters	53
5.3.2 Application	54
5.4 Varc Mark Space Level Transmitter (MSTX)	57
5.4.1 Parameters	57
5.4.2 Application	59
6 Installation	61
6.1 General Safety Guidelines	61
6.2 Installation Safety Guidelines	61
6.3 Installation	62
6.3.1 Mounting the Tank Gate Interface	62

6.3.2 Select the Unit Address	62
6.3.3 Wiring Up Power	62
6.3.4 Grounding	64
6.3.5 Installing Communications	64
7 Using ViewRTU	65
7.1 Overview	65
7.2 System Requirements	65
7.3 Installing ViewRTU	65
7.4 Executing ViewRTU	65
7.4.1 ViewRTU window	67
7.5 The ViewRTU Menu Bar	67
7.5.1 The File Menu	67
7.5.2 The Point Menu	68
7.5.3 The Config Menu	71
7.5.4 The Communications Menu	73
7.5.5 The Options Menu	75
7.5.6 The Help Menu	76
7.6 Using ViewRTU	77
7.6.1 Overview	77
7.6.2 Configuring Single Points	78
7.6.3 To modify a Value	80
7.6.4 Configuring Multiple Points	82
7.6.5 Creating and Editing Connections	88
8 Troubleshooting	91
8.1 Overview	91
8.2 Troubleshooting the Tank Gate Interface	91
8.2.1 LED Displays under normal conditions	91
8.2.2 LED Displays under Abnormal Conditions	92
8.2.3 Using the Tank Gate Interface Push-buttons	92
8.2.4 Performing a Hard Reset	93
8.3 Maintenance	94
A Appendix - Order Codes	97

1 Overview

The 8300 series Tank Gate Interface acts as a tank gauge interface for data acquisition and host gateway for tank farm, pipeline or refinery applications. Options are available for interfacing to nearly any brand of tank gauge equipment or technologies, making it possible to integrate float and tape transmitters, HTG, servo, magnetostrictive and radar gauges.

Each 8300 series Tank Gate Interface unit has a built-in motherboard and specific communications module based on the local field protocol or tank gauging instrumentation requirements. The motherboard contains a serial data link to enable communication to a host PC, PLC, or DCS.

Note! Each intelligent module is identified by a 82xx designation that matches the product designation, for example, the 8303 TGI contains a 8203 communications module.

Each module contains its own processor for fast and reliable field data scanning. Compatibility of every module also makes configuration of the internal database simple and straightforward.

1.1 Versions

The 8300 series Tank Gate Interface is available in a number of versions that can interface to a variety of field devices and intelligent instrumentation via interface modules listed below:

- 8303-2 Dual RS-485 (MODBUS) Communications Tank Gate Interface
- 8303-6 Dual RS-485 (GSI ASCII) Communications Interface Module
- 8310 Varec Mark/Space (Varec 1800, 1900, 4000) Tank Gate Interface
- 8311-1 Current Loop (Whessoe Bus) Tank Gate Interface
- 8311-2 Current Loop (GPE) Tank Gate Interface
- 8312 Saab (TRL/2) Tank Gate Interface
- 8314 Enraf (811, 802/812, 854, 873) Tank Gate Interface
- 8315 L&J Tankway (MCG 1000, MCG 1500, MCG 2000) Tank Gate Interface
- 8316 LON (Prime Measurement 3500 ATG) Tank Gate Interface
- 8317 Dual RS-232 Veeder Root (TLS 350) Tank Gate Interface

1.2 Features

- Inputs are reported to Host Computer by Exception or Scanned Poll
- Built-in Software Function Library
- Surge Protection Conforming to ANSI/IEEE C37.90a-1974
- Host Communication via RS-232, RS-485, radio, modem or fiber optic link
- Industry Standard Protocol: Modbus
- Quick-Disconnect I/O Terminations
- Modular Construction for Optimum Expandability
- Non-Volatile Database

1.3 Applications

The 8300 series Tank Gate Interface is ideally suited for Tank Farm, Terminal, Pipeline and Refinery applications. It is an effective solution used in SCADA applications.

- Level, temperature, pressure, flow, local indication, and alarms
-

1.4 Specifications

1.4.1 System Design

- 16-bit processor with optional intelligent communication modules
- Intelligent field device communications
- 128K bytes Non-Volatile Database Memory
- Serial RS-232
- Visual indication – 4 LEDs on main board indicate power and status

1.4.2 Software Functionality

- Tank gauge scanning – Data acquisition of measured values from connected tank gauges/transmitters
- Service & diagnostics*
- Gauge diagnostics
- Read level, temperature and status data from gauge/transmitter

1.4.3 Host Communication

- Host comm. ports – 2
- Comm. type:
 - COM 0: RS-232C
 - COM 1: RS-232C or RS485
- Baud Rate – selectable baud rate depending on equipment parameters
- Protocol – Modbus™ RTU protocol
- Mode – RTU mode, master and slave
- Media access – Master/Slave

1.4.4 Modbus Functionality

- Modbus™ commands – 3, 4, 5, 6, 15, 16
- Modbus™ mapping – Configurable

1.4.5 Power Supply

- Supply 100...240 Vac, 50/60 Hz

1.4.6 Power consumption

- 50 VA max (500 mA)
-

1.4.7 Surge protection

- Gas Discharge Tubes (GDTs) and clamping diodes on all field inputs, power supply inputs and communications channels

1.4.8 Operating temperature

- -40...+185 °F (-40...+85 °C)

1.4.9 Humidity

- 5...95% (non-condensing)

1.4.10 Storage temperature

- -40...+212 °F (-40...100 °C)

1.4.11 Mechanical Construction

- Dimensions (HxDxW) – 2.5" (64 mm) x 8.6" (220 mm) x 5.2" (133 mm)
- Material – Aluminum Powder coated

*Gauge/transmitter Dependent

2 Hardware

The Tank Gate Interface consists of an enclosure, motherboard, single tank gauge interface module and connectors.

2.1 Hardware Block Diagram

A Tank Gate Interface hardware functional block diagram is shown below. This diagram shows the relationship between major subsystems and components in the Tank Gate Interface.

The heart of the Tank Gate Interface is an Intel 80C188EB microprocessor operating at 18.432 MHz. Designed specifically for real-time embedded applications, the μ P includes timer/counters, an interrupt controller, and chip-select circuitry. It also includes 2 serial channels that are designated as COM0 and COM1.

2.2 Motherboard Description

The motherboard description is broken into three sections. Each section identifies the location of the components on the motherboard. When necessary, a brief description of the component is provided. These sections are listed below:

- Power Supply
- Switches and Indicators
- Communications

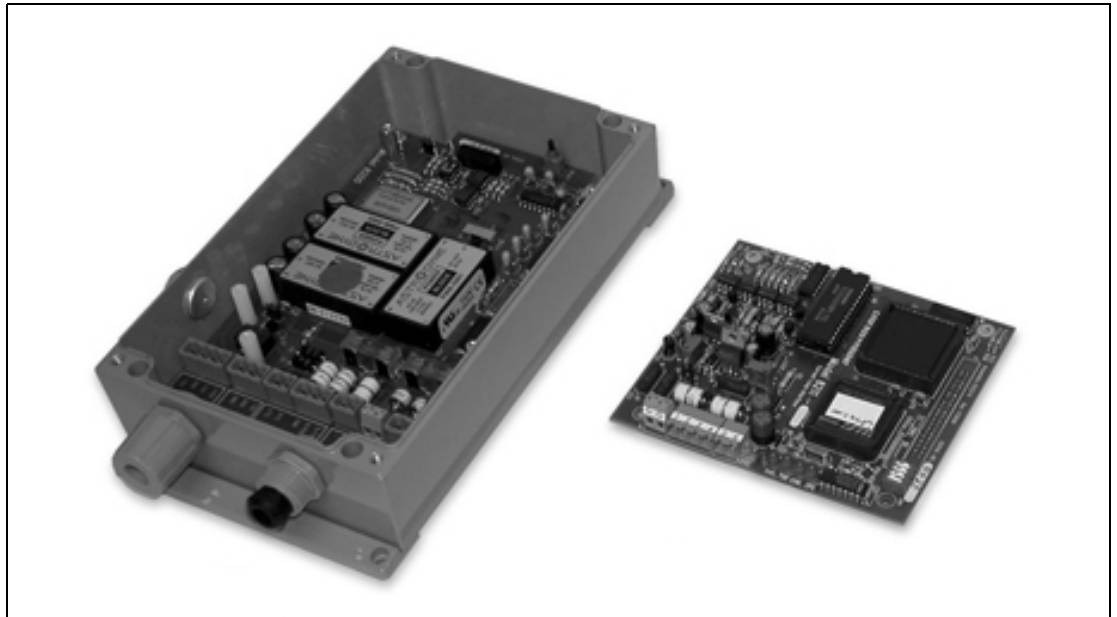

Figure 2-1: Tank Gate Interface Hardware Components

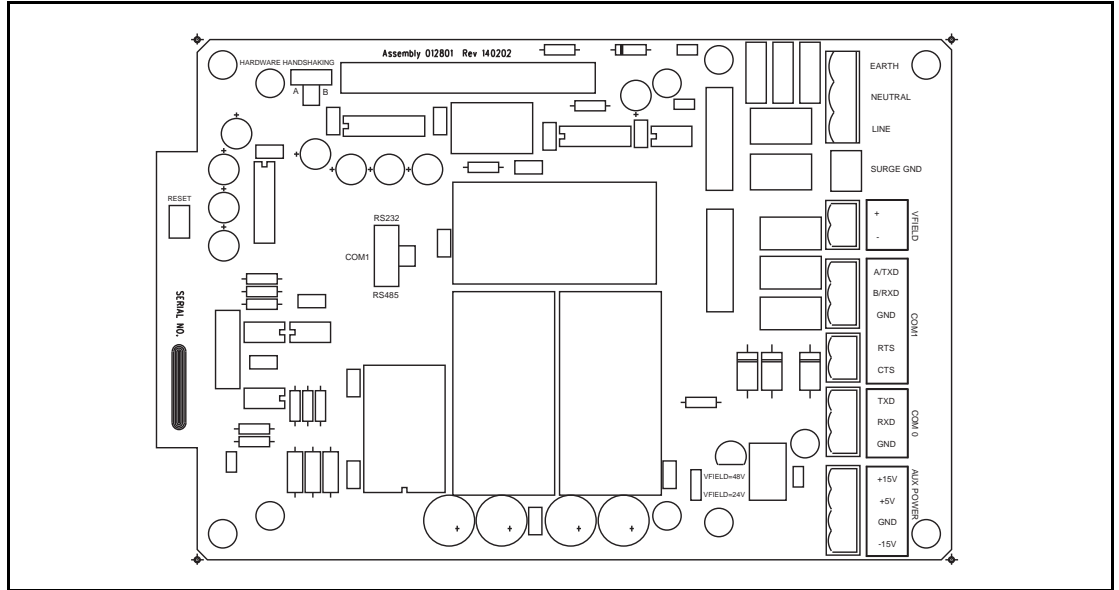

Figure 2-2: The Tank Gate Interface Motherboard

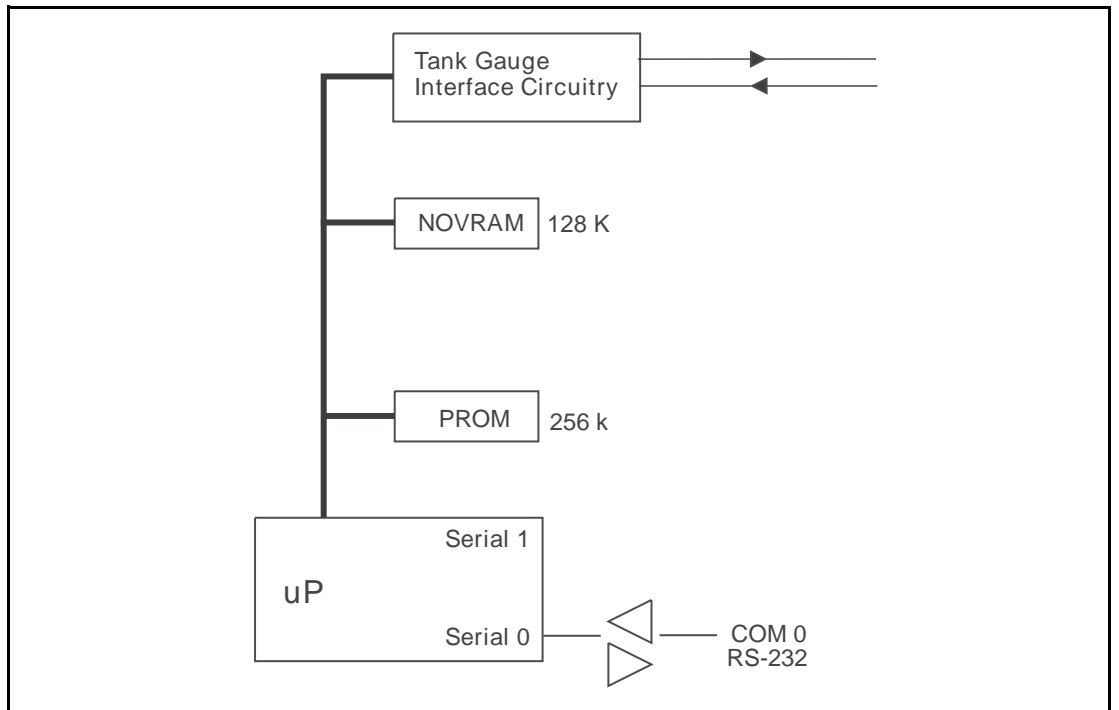

Figure 2-3: Tank Gate Interface Functional Block Diagram

2.2.1 Power Supply

- Unit AC Power terminal block (J2)
- Surge Protection terminal block (J4)
- Field Power terminal block (J3)
- Auxiliary DC Power Output terminal block (J8)
- AC Power fuses (500 mA – 250V 5x20 mm) (F1, F2)
- Field Voltage Selection Jumper (W3)

2.2.1.1 Unit AC Input Power terminal block (J2)

The Unit AC power terminal block is used to provide AC power to the Tank Gate Interface. The power requirements for the Tank Gate Interface are 100–240 VAC, 50/60 Hz. The AC Input Power terminal block is shown in the figure below.

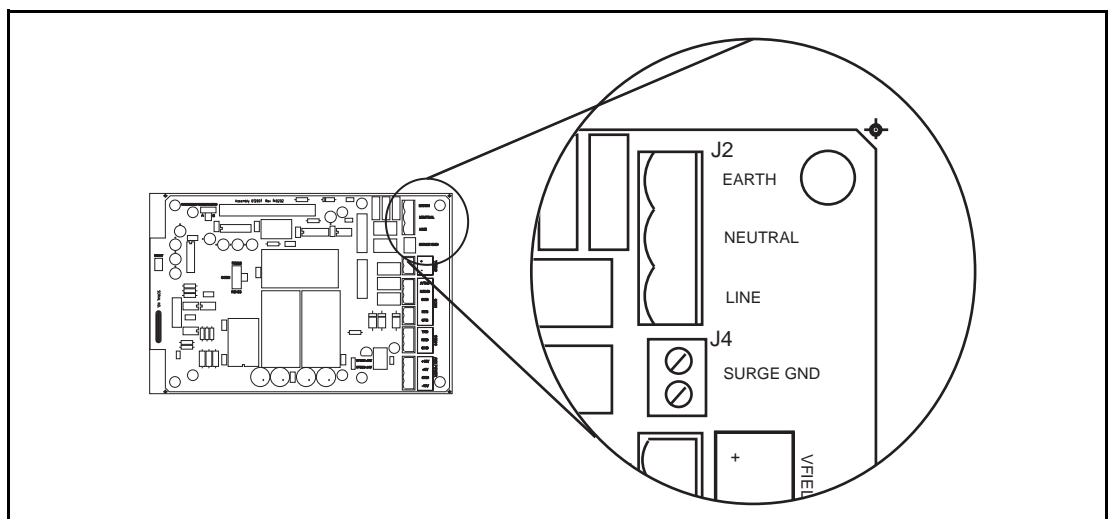

Figure 2-4: AC Input Terminal Block

2.2.1.2 Surge Protection (Surge Gnd) terminal block (J4)

The Surge Gnd terminal block is used to connect the surge protection components (gas tubes, MOVs) to earth ground. Ensure there is a low impedance path (< 1ohm) to earth ground (a ground rod or grounding system).

2.2.1.3 Field Power (VFIELD) terminal block (J3)

The Field Power terminal block, referred to as VFIELD, is used to provide power for field instruments. The output is configurable using jumpers (Jumper W3, discussed below).

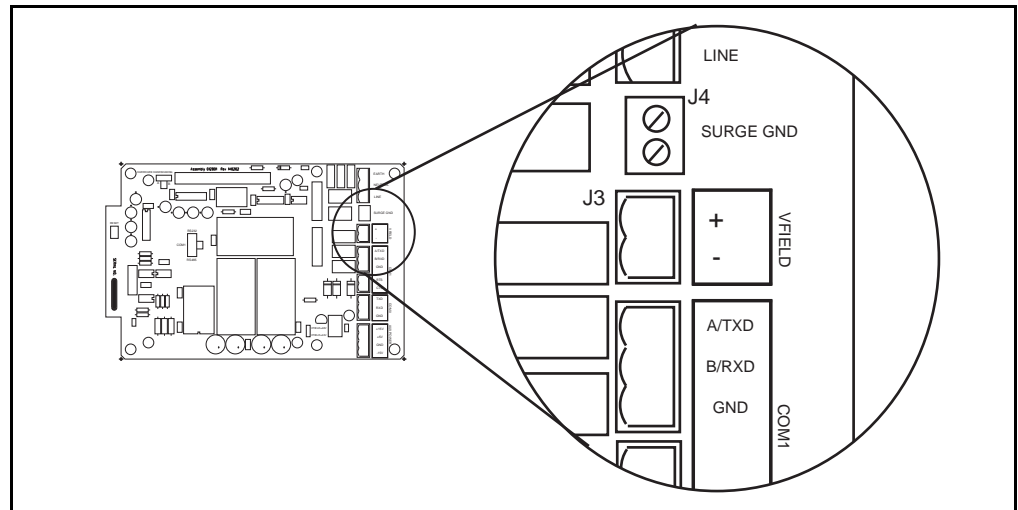

Figure 2-5: Field Power Terminal Block

2.2.1.4 Auxiliary DC Output Power terminal block (J8)

The Auxiliary power terminal block is used when external equipment must be powered from the Tank Gate Interface's internal power supply. The triple output power supply provides +5, +15 and -15 Volts. These are rated 210 mA, 50 mA, and 5 mA, respectively. The DC Power terminal block is shown below.

T

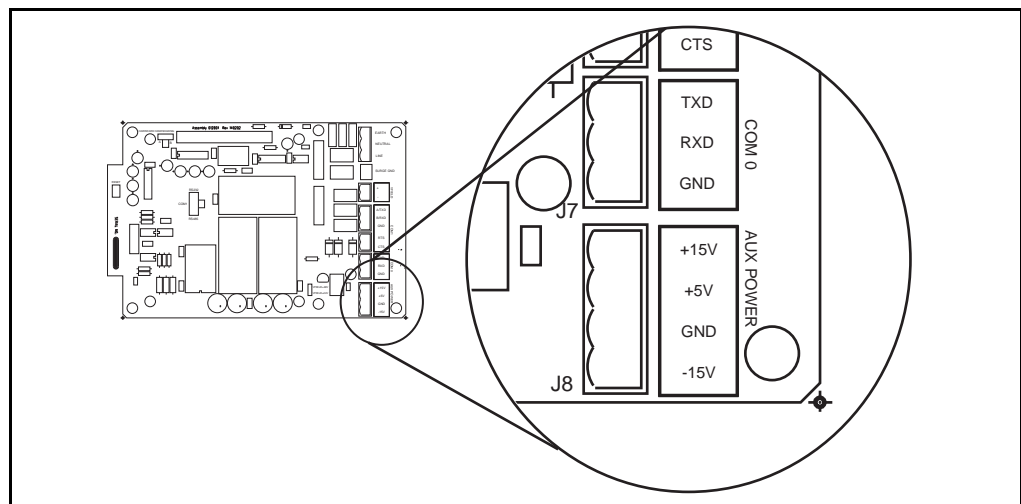

Figure 2-6: DC Input Voltage Terminal Block

2.2.1.5 AC Power Fuses (F1,F2)

The AC Power Fuses provide protection for the AC input power. The two fuses, F1 and F2, are rated at 500 mA, 250 V.

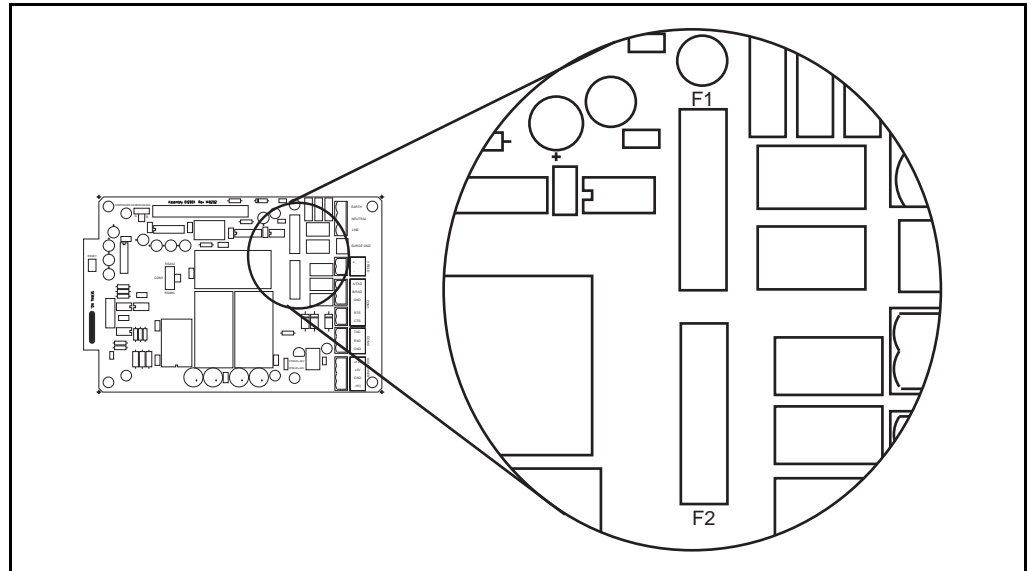

Figure 2-7: AC Power Fuse

2.2.1.6 Field Voltage Selection Jumper (W3)

The Field Voltage Selection Jumper W3 determines the voltage available at the VFIELD terminals (J3). The Field Voltage can be configured for +24 VDC or +48VDC. At +24VDC, there is 230 mA of field power available. At +48VDC, there is 230 mA of field power available.

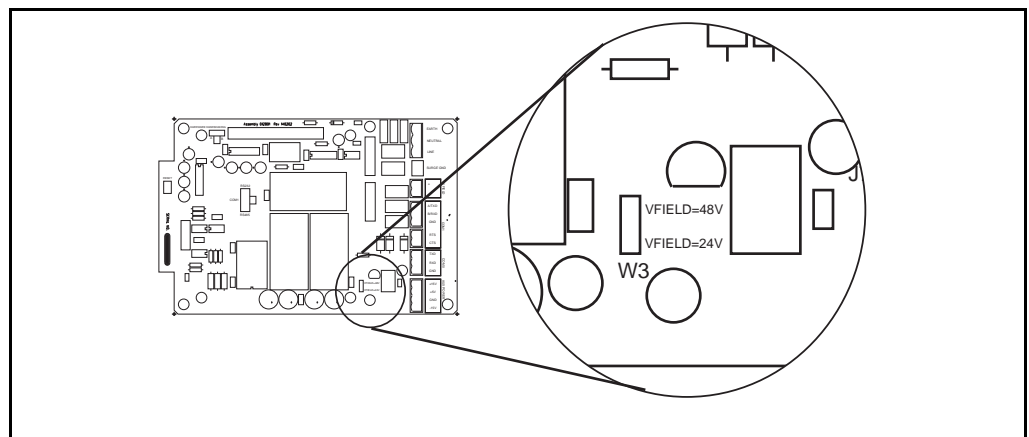

Figure 2-8: Selection Jumper W3

2.2.2 Switches and Indicators

2.2.2.1 Reset push-button (SW3)

The RESET Switch is used to re-initialize the system hardware by causing it to go to a known starting state. This switch may be pressed at any time; however, it will do the following:

- Re initialize System Hardware
- Clear Scratch Memory
- Verify Database and Re initialize if Invalid
- Reset All Timers
- Enable Communications

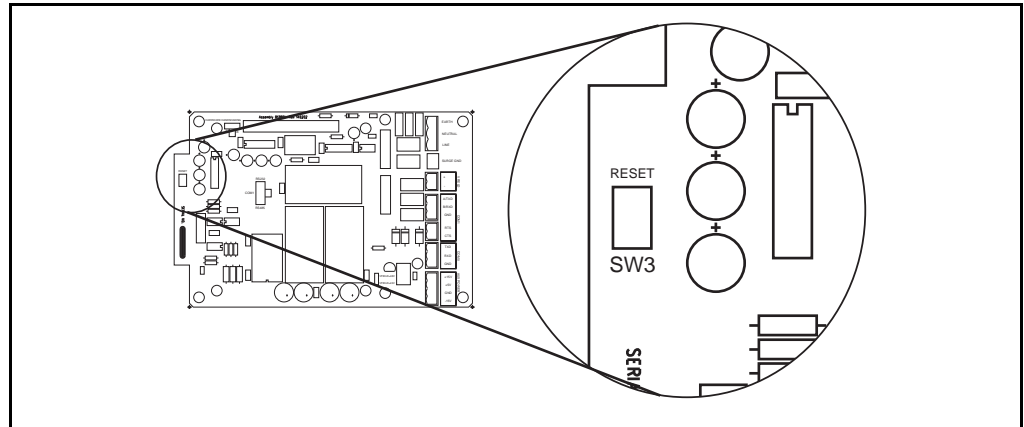

Figure 2-9: Switches SW3 on the Tank Gate Interface Motherboard

2.2.2.2 Hard Reset

A special form of Reset is available for occasions when the battery backed-up data base must be re-initialized. This type of reset, the Hard Reset, can be performed before a database is downloaded from a host PC.

Caution! The Hard Reset should be used as a last resort if the Tank Gate Interface is not functioning. A Hard reset clears the installed database. For the Hard Reset procedure, refer to the Troubleshooting and Maintenance chapter.

2.2.3 Communications

The Communications installation requires connection of the appropriate communication cable to one of two connectors. The available options include RS-232 and RS-485 communications.

- COM0 (RS-232) (J7)
- COM1 (RS-232 or RS-485) (J5)
- COM1 Transmit Control (RS-232) (J6)
- COM1 Hardware Handshaking Switch (SW1)
- COM1 RS-232/RS-485 Selection Switch (SW2)
- COM1 RS-485 Terminating Resistor Jumper (W2)

Note COM1 is not available on the 8315 Tank Gate Interface

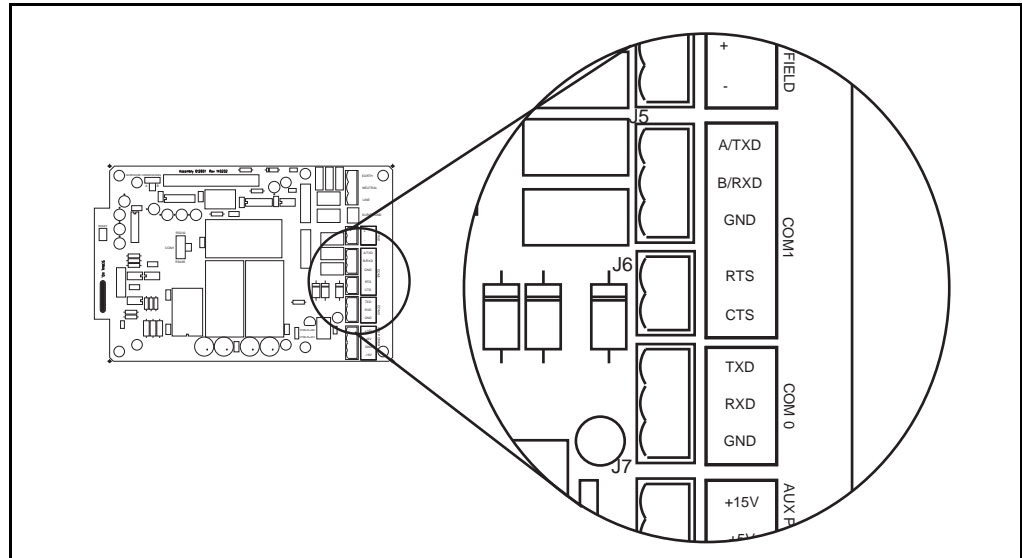

Figure 2-10: COM1 J5 Terminal Block

2.2.3.1 COM0 (J7)

COM0 is an RS-232 port for use in diagnostic testing/local programming or communications to a host system. The protocol defaults to Tank Gate Interface Slave at the 9600 baud, 8 data bits, and no parity (for use with ViewRTU or FuelsManager).

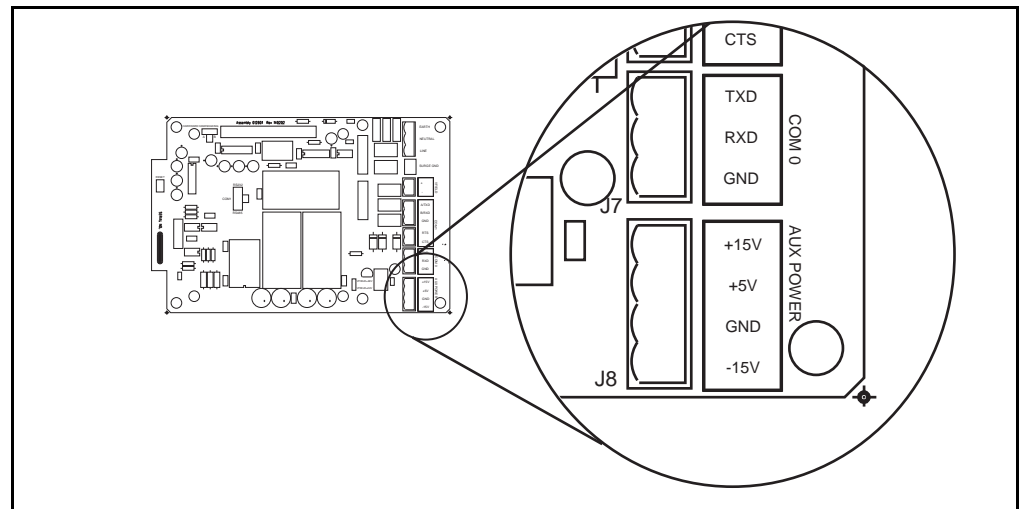

Figure 2-11: COM0 J7 Terminal Block

2.2.3.2 COM1 (RS-232/RS-485) (J5)

Note COM1 is not available on the 8315 Tank Gate Interface

RS-232 is one of the two types of high-speed serial communications channels available to interface to Host systems using several different protocols. RS-232 will operate at distances up to 100 feet, while RS-485 allows multidrop communications at distances up to 4000 feet. RS-232 can be used for flexibility in configuring other types of communications links. Other variations of RS-232 communications interfaces include radio, modem and fiber optic interfaces.

The choice of RS-232 or RS-485 is determined by the COM RS-232/RS-485 Selection Switch SW2.

2.2.3.3 COM1 RS232/RS-485 Selection Switch (SW2)

Note COM1 is not available on the 8315 Tank Gate Interface

Switch SW2 determines whether RS-232 or RS485 is used. Note that the Hardware Handshaking Switch SW1 affects the operation of COM1.

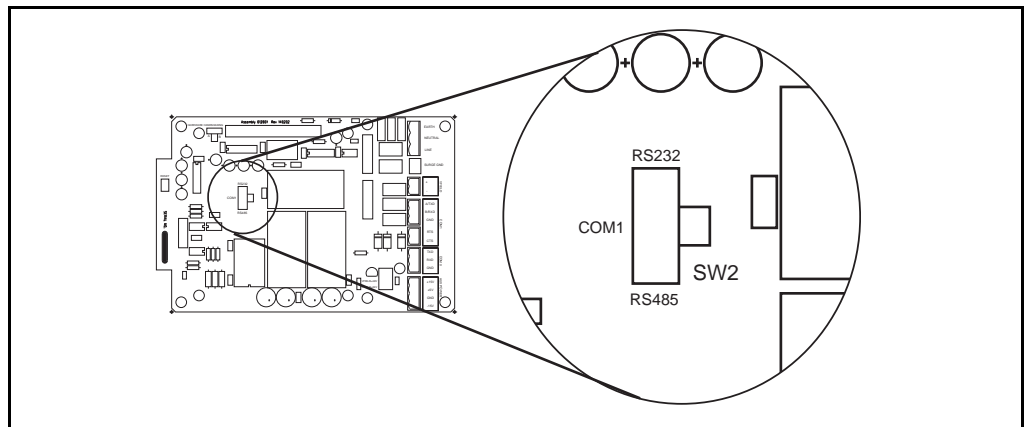

Figure 2-12: COM1 SW2 Switch

2.2.3.4 COM1 Hardware Handshaking Switch (SW1)

Note COM1 is not available on the 8315 Tank Gate Interface

For RS-232, there are two different settings. One setting is used if hardware handshaking (RTS/CTS) is required. The other setting eliminates the need for hardware handshaking. Set the Hardware Handshaking Switch to the 'A' position to use RTS/CTS when a modem or signal converter is involved and requires RTS/CTS to operate. The RTS and CTS signals will be available on terminal block J6. If the connection is direct using RS-232, jumper RTS to CTS by setting SW1 to the 'B' position.

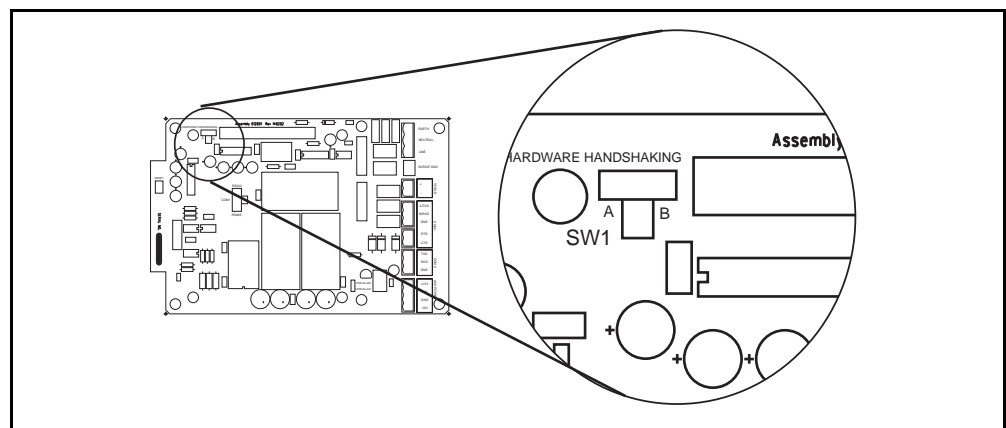

Figure 2-13: COM1 SW1 Switch

For RS-485, set the Hardware Handshaking Switch SW1 to the 'A' position. Refer to the following table:.

Comm. Physical Layer	Hardware Handshake	SW1 Setting	SW2 Setting	Notes
RS-232	No	A	UP (towards the RS-232 side)	Use with a PC. Signals at terminal block J5 will be RS-232
RS-232	Yes	B	UP (towards the RS-232 side)	Use to communicate to systems that require Request To Send (RTS) in order to transmit (Modems, Radios, etc.) RTS and CTS signals will be available at terminal block J6
RS-485	Yes	A	DOWN (towards the RS-485 side)	Always SW1 set to the A position when using RS-485..

Table 2-1: Tank Gate Interface Communications Cable

The layout for the RS-232 cable between the PC and the Tank Gate Interface is shown in the following illustrations.

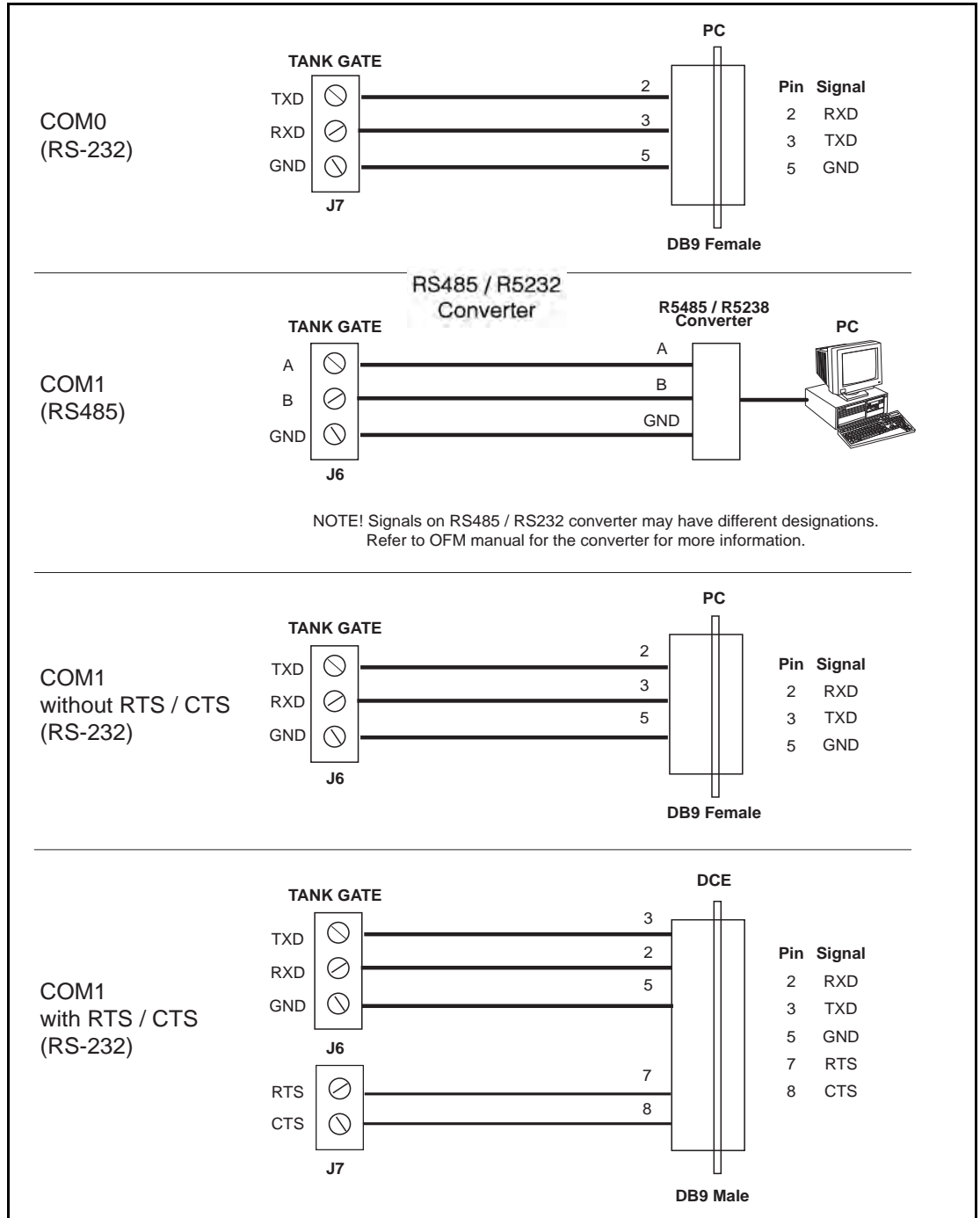

Figure 2-14: COM1 Cable without RTS/CTS

Note COM1 is not available on the 8315 Tank Gate Interface.

3 8210 Varec Mark/Space Communications Interface Module

This communications interface module is the processing card that mounts on the Tank Gate Interface (TGI) motherboard. The firmware installed on this card determines which protocol is provided.

Firmware Version	Protocol	Software Blocks
MSTG1_11	Varec Mark/Space	See section 5 on page 43

3.1 Features

- Supports up to 50 tanks
- Communicates using Mark/Space protocol
- Interfaces to Whessoe Varec Model 1900 compatible Tank Gauge transmitters
- ANSI/IEEE surge protection

The Model 8210 interface with tank gauge transmitters uses Whessoe–Varec’s Mark/Space protocol to communicate. There are a number of transmitters that are Mark/Space compatible, including:

- Whessoe–Varec Model 1800
- Whessoe–Varec Model 1900
- Whessoe–Varec Model 4000 ATT
- Whessoe–Varec Model 4100 MFT
- Whessoe–Varec Model 4200 HIU
- Whessoe–Varec Model 2046
- Gauging Systems Inc. Model 1900/1901
- Gauging Systems Inc. Model 2000

Note The 8310 Tank Gate Interface uses the 8210 communications module.

The 8210 communications module requires an external +48VDC power supply. It is also possible to use the +48VDC power supply of the TankGate to power the tank gauge transmitters, if there are fewer than 15 devices.

3.1.1 Description

The components of the 8210 communications module are illustrated in the following figure. This section explains how to connect field wiring and to configure jumper settings.

- Unit ID DIP Switch (SW 1)
- LED Indicators (D1 – D5, D14)
- +48V Line fuse (1A 250V TR5) (F1)
- External Power Connector (+48V) (J2)
- Surge/Shield ground connector (J4)
- Field Wiring termination block (J3)

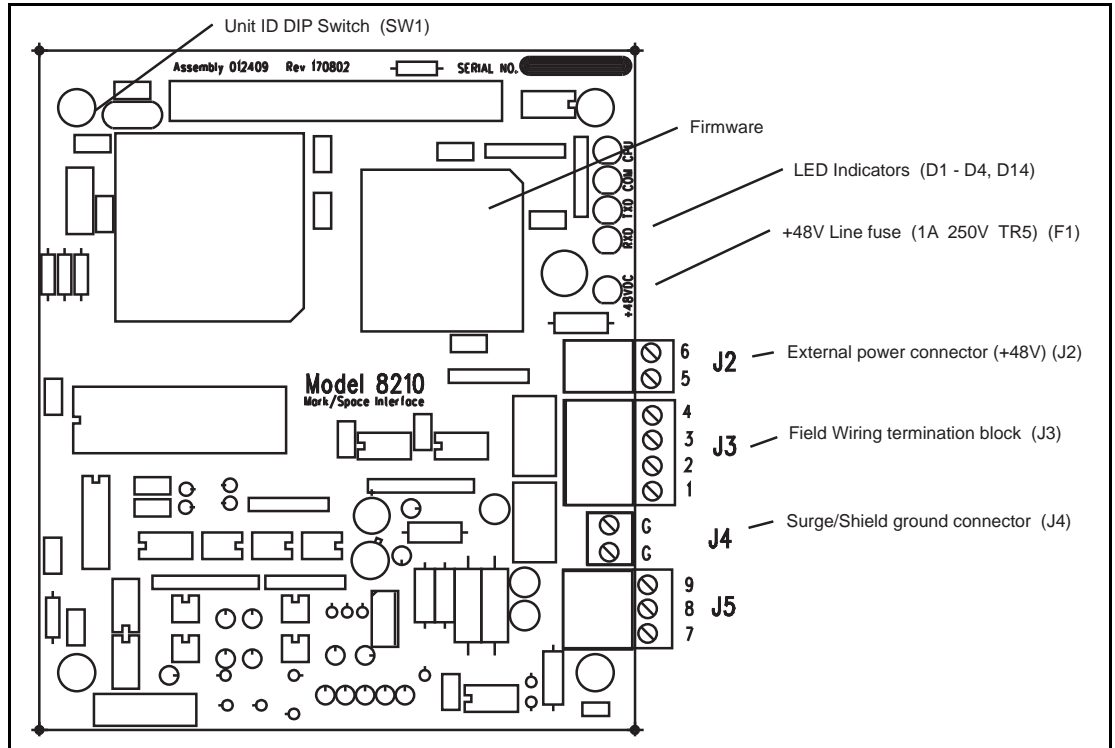

Figure 3-1: Varec Mark/Space Tank Gate Interface Module

3.1.2 ID DIP Switch (SW1)

The dip switch is used for setting the ID number (1-14). The ID is a binary number representing the address of the TGI.

Table 3-1: ID DIP Switch settings

CLOSED	1	2	3	4	OPEN	1	2	3	4
				■		■	■		
Address 1 Shown									
Binary	8	4	2	1	Binary	8	4	2	1
Switch #	1	2	3	4	Switch #	1	2	3	4
Address 1	o	o	o	c	Address 8	c	o	o	o
Address 2	o	o	c	o	Address 9	c	o	o	c
Address 3	o	o	c	c	Address 10	c	o	c	o
Address 4	o	c	o	o	Address 11	c	o	c	c
Address 5	o	c	o	c	Address 12	c	c	o	o
Address 6	o	c	c	o	Address 13	c	c	o	c
Address 7	o	c	c	c	Address 14	c	c	c	o

3.1.3 LED Indicators (D1-D4 & D14)

The LED displays indicate the status of the TankGate. The LED that is adjacent to the External Power Connector indicates that external power is applied.

- CPU: CPU activity
- COM: Communication between the TankGate and the host system.
- TXD: Transmitting data to tank gauge
- RXD: Receiving data from tank gauge
- +48V: Indicates +48V is present

Figure 3-2: LED Indicators

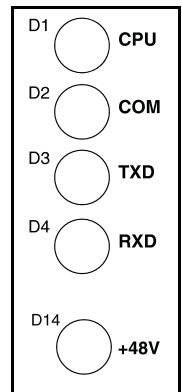

3.1.4 External Power Connector (+48V) (J2)

An external +48 VDC power supply is required to power the tank gauge transmitters. Connect the +48 VDC external power supply as shown below:

Figure 3-3: External Power Connector

It is possible to use the +48 VDC available from the VFIELD terminal if there are fewer than 15 devices.

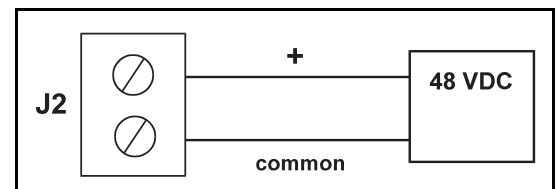

3.1.5 Surge/Shield Ground Connector (J4)

Caution! This ground connection is important for system safety.

- Connect a 14 AWG copper wire between the ground terminal (J4) and a good earth ground. Perform this step before connecting ANY other wires.
- Verify that the resistance in this connection does not exceed 1 ohm.

3.1.6 Field Wiring terminal block (J3)

A schematic illustrating the terminal connections of the TankGate is shown below:

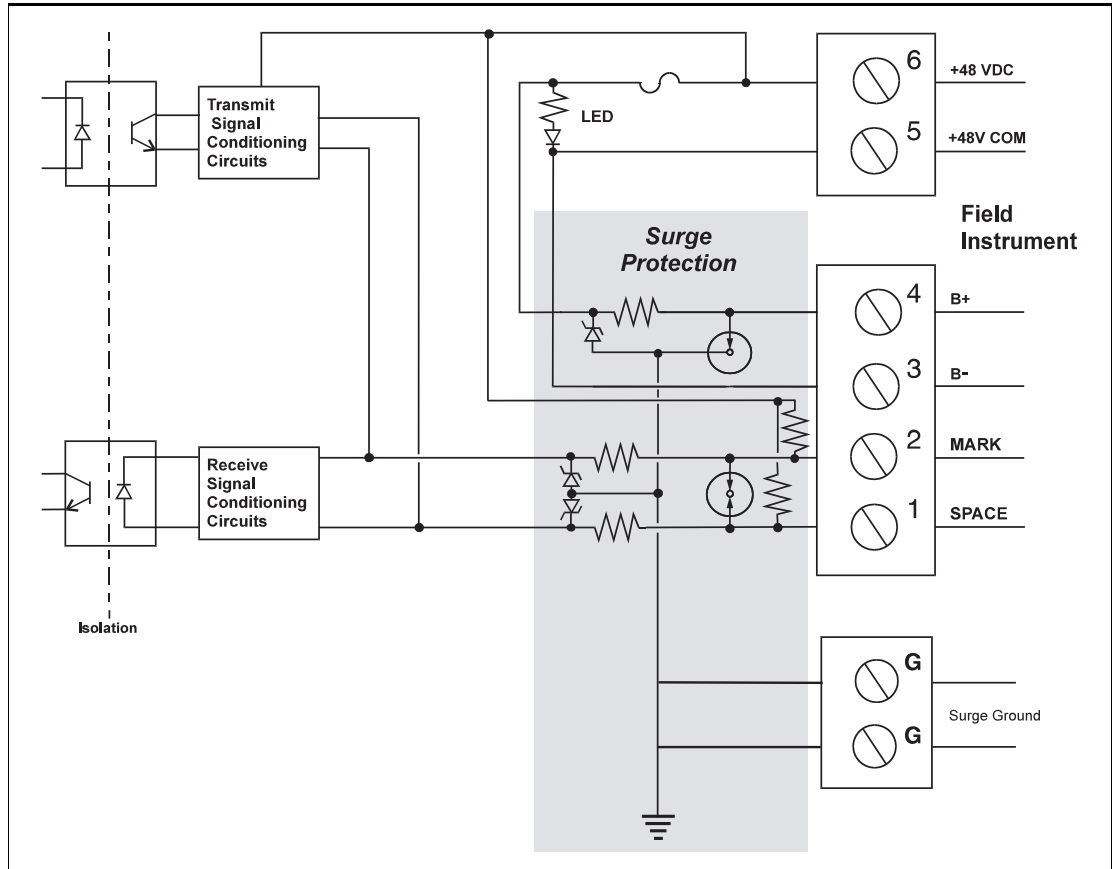

Figure 3-4: Circuitry

Connect the field wiring

- Connect the wiring from the Model 8310 to the appropriate device.

The Model 8310 can be connected to a variety of different transmitters. Three examples are shown below.

Note! Refer to your tank transmitter user's manual for instruction on wiring the devices to the Model 8310. The following schematics are provided only as examples

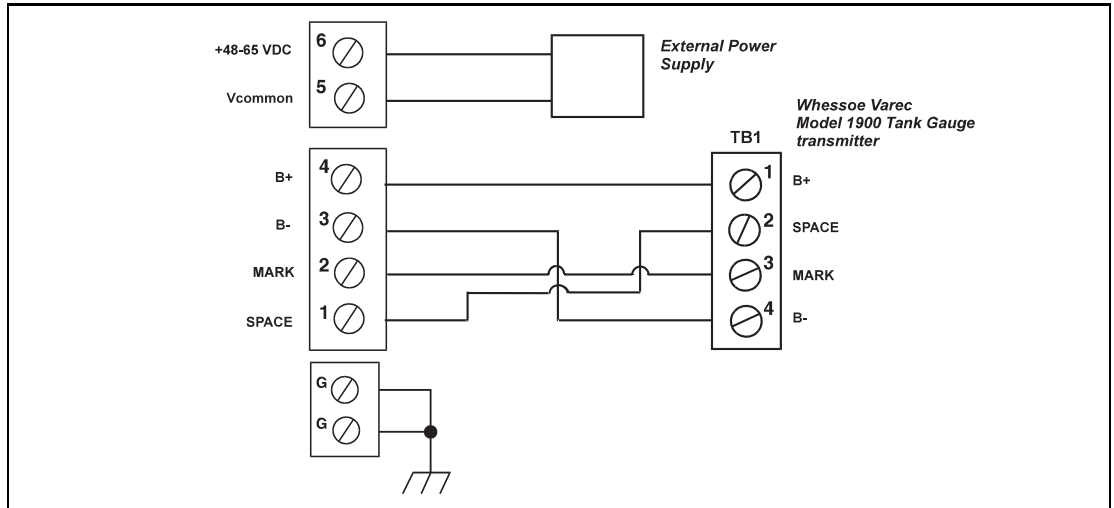

Figure 3-5: Whessoe Varec Model 1900 Micro 4-Wire transmitter

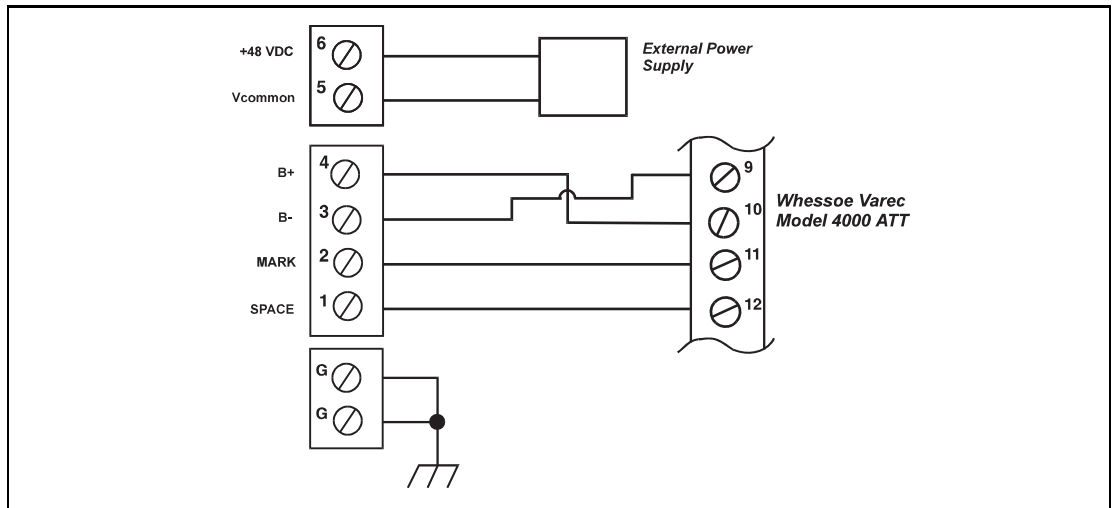

Figure 3-6: Whessoe Varec Model 4000 ATT

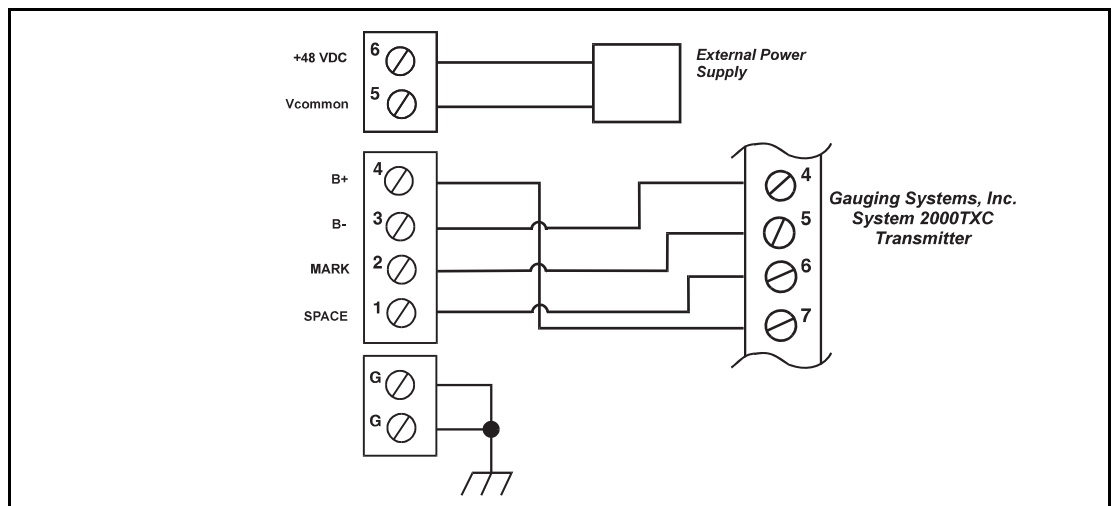

Figure 3-7: Gauging Systems, Inc. - System 2000TXC Transmitter

4 Software Description

The Tank Gate Interface software platform is based on a real-time, multi-tasking operating system. The software consists of I/O scanning functions for data acquisition, a database/database manager and communication functions for data transfer.

Note COM1 is not available on the 8315 Tank Gate Interface.

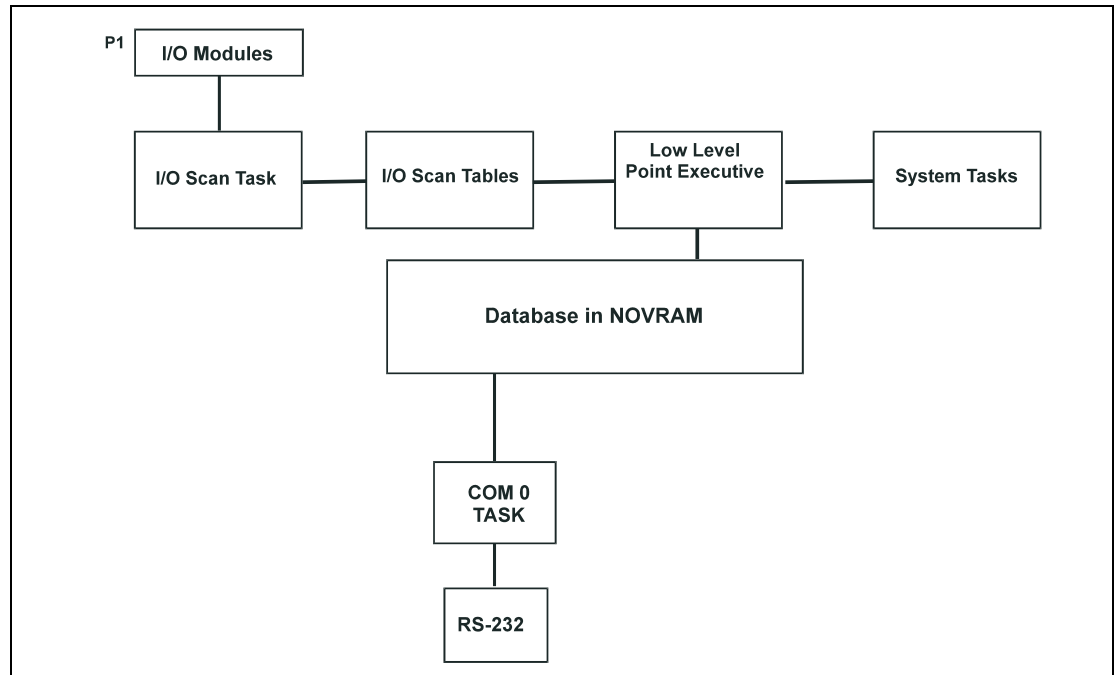

Figure 4-1: Software Block Diagram

4.1 Software Features

4.1.1 Real-Time / Multitasking Executive

The operation of the Tank Gate Interface is based on a highly reliable, field-proven real-time multitasking executive. It provides task switching based on real-time events and interrupts, message passing and task priorities. Its capabilities also include timed suspension of tasks, queue handlers and interrupt processing tasks.

4.1.2 Real-Time Clock

Integral to the real-time executive is the system's real-time clock. All timed events of the Tank Gate Interface are coordinated by this clock. In addition to the real-time executive interaction, all field data scanning is coordinated by the real-time clock.

4.1.3 Automatic Fault Recovery

The Tank Gate Interface has a watchdog timer that is periodically strobed by the microprocessor. Should the processor suffer a lapse due to hardware or software failure, the watchdog timer will time out and the Tank Gate Interface will then be reset and normal operation will resume.

4.1.4 Communications

There are two communications tasks – one for each of the communication channels. COM ports 0 and 1 are used to interface to external devices or host systems. Refer to the Hardware Chapter for the location of these ports.

Note COM1 is not available on the 8315 Tank Gate Interface.

COM0 and COM1

COM 0 and 1 can be configured for communications to Host systems using a variety of protocols. For COM 0 and 1 the communication interfaces include the following:

- RS-485 for use in multi-drop configurations or long cable runs (or both)
- RS-232 for flexibility in configuring other types of communications links such as radio and fiber optic interfaces
- RTS/CTS lines are available for hardware handshaking.

4.1.5 Protocols

The Tank Gate Interface is fully compatible with FuelsManager® software. It is also compatible with a variety of other Host systems including through Modbus protocol.

- RS-485 for use in multi-drop configurations or long cable runs (or both), with an RS232-to-RS485 converter.
- RS-232 for flexibility in configuring other types of communications links such as radio and fiber optic interfaces.

The default communication settings for the COM ports are as follows:

COM Port	Protocol	Baud Rate	Data Bits	Parity	Stop Bits
COM0	RTU Slave or Modbus – Auto-sensing	9600	8	N	0
COM1	Modbus	9600	8	N	0

Note COM1 is not available on the 8315 Tank Gate Interface.

4.1.6 Data Scanning Task

The Data Scanning Task is dedicated to the scanning of field input data from tank gauges. The input data is stored in arrays that are subsequently accessed by the Point Executive.

4.1.7 Database Manager

The Database Manager is a collection of programs and data. The Database Manager allows the Tank Gate Interface system executive to access data from the database in an organized and program-independent manner. It resides in non-volatile RAM.

The Database Manager also contains a Database Dictionary. This dictionary describes how the database is organized and also provides information describing how data should be presented to the operator.

After power-up or system reset, a CRC verification of each point in the database is performed. If the CRC does not have a match for the point, then it is disabled and a flag is set indicating that the point is invalid.

4.1.8 System Tasks

System tasks include the Calendar Task, which manages Time and Date functions. Other system tasks include utility routines for checksum calculations, diagnostics, start-up and initialization.

4.1.9 Tank Gate Interface Software Blocks

The user can configure pre-defined subprograms known as Software Blocks. These software blocks program the Tank Gate Interface to perform various tasks, such as scaling an analog input value, or scanning level, temperature and status information from a tank gauge. Various software blocks are available depending on the communication module. Each Software Block contains all the logic, constants and data to perform a particular function. Every system function of the Tank Gate Interface is accessible via a Software Block. The user only has to add Software Blocks using ViewRTU and then configure a few parameters in order to perform a desired function.

4.2 Database Organization

Points are the individual instances of software blocks. Examples include Whessoe Varec 1900 (MSTX) and SCALER points. In both cases the user configures the Config parameters and is provided real time data through the Dynamic parameters.

4.2.1 Point Format

Data parameters in the Tank Gate Interface are addressed using a "Type.Number.Parameter" format. For example, "MSTX.02.Level" refers to MSTX Tank Gauge #2's IEEE floating point level. This format and corresponding fields are described below.

The TYPE field represents the Point Type. There are many different point Types in the Tank Gate Interface, referred to generically as Tank Gate Interface Software Blocks. Some of the point types include the COM (Communications), SYS (System), MSTX (MSTX Tank Gauge) point types. Each Type performs a different function.

The NUMBER field represents the instance of the point type. For example, the AI point may have up to 32 instances, which are addressed using the NUMBER field. Each instance shares the same data structure definition, yet each point has unique data values. In the case of the AI software block, each point manages a single input channel.

The PARAMETER field represents the items in the data structure of the point type. Examples of parameters include Value, Status, PntRef and RawValue. This field is explained in greater detail in the following section.

4.2.2 Parameter Description

Each parameter is defined by its Parameter Class and Data Type. The following subsections describe Parameter Classes, Parameter Data Formats and Common Parameters.

Parameter Classes

Each parameter, such as Value or Channel, is classified as one of the following classes:

Parameter Class	Description
Config	Configuration parameters such as channel numbers, tags, descriptions, ranges, operating modes, point references, constants for formulas and timing information.
Dynamic	Real-time data such as the value or the status. Dynamic data is calculated or measured during point execution scans, which occur every 250 msec.

Parameter Class	Description
Command	Output command data
Constant	Weights & Measures parameter
Scratch	Temporary data that is typically hidden from the user
System	System data (should not be changed by the user)

The user-related parameters are the Config, Command and Dynamic parameters. These parameters are available in the Edit Point window of ViewRTU. The remaining parameters are internal to the Software Block.

Note ViewRTU inserts default values for the Config parameters when the point is first defined. It is usually only necessary to fill in a few configuration parameters, such as channel numbers, to configure references and to configure links to other points.

Parameter Data Formats

Data is stored in the Tank Gate Interface as one of the following formats:

Data Format	Description
Byte	8-bit value (-127 to 128)
Unsigned Byte	8-bit value (0 to 255)
Coded	Unsigned Integer representing a digital state such as 'On,' 'Off,' 'Open,' 'Closed,' etc.
Integer	16-bit value (-32766 to 32767)
Unsigned Integer	16-bit value (0 to 65535)
IEEE floating point	32-bit value with mantissa and exponent
Time	Unsigned Long Integer representing the number of milliseconds since Jan. 1, 1970.
Tag	ASCII character strings, variable in length. Used for Tag and Description parameters
Point Reference	Reference to a point parameter. Format is TYPE.NUMBER.PARAM where TYPE is AI, DI, DO, etc. NUMBER is point number, 0-255 PARAM is the parameter of interest, such as Value or Command. example: AI.00.Value
Unsigned Long Integer	32-bit value (0 to 4,294,967,295)
Pointer	32-bit value representing a pointer to another parameter or memory location.
Long Integer	32-bit value
Integer (Hex format)	Integer in Hex (0x0000 to 0xFFFF)
Time HH:MM:SS	Unsigned Long Integer representing the number of milliseconds since midnight.
Time MM/DD/YY	Unsigned Long Integer representing the number of milliseconds since Jan. 1, 1970.
Unsigned Long Integer (Hex format)	Unsigned Long Integer in Hex (0x00000000 to 0xFFFFFFFF)

Common Parameters

The following parameters are found in almost all point types. These parameters are described below:

PntChecksum Parameter

The PntChecksum is a CRC-16 checksum of the Configuration Parameters of a point. Most points have the PntChecksum parameter; a few like the CLK (Clock) Point, DIAG (Diagnostics) Point, and the register points (BREG, IREG, and DREG) do not. Any time a Configuration Parameter is changed, the Tank Gate Interface re-calculates the checksum. The PntChecksum is used at initialization to validate each point in the database.

PntStatus Parameter

The PntStatus parameter gives information about point execution. Refer to the information provided for each Software Block about the particular use of the PntStatus parameter.

Elapse Parameter

The Elapse parameter usually indicates the time of the last point execution. It is used as the basis for automatic Change of State notifications.

Value Parameter

The Value parameter indicates the real-time value of the point. In the case of DI points, the Value represents a Coded value (i.e., On, Off, Opened, Closed, etc.) AI points represent the Value in an IEEE floating point format. In most cases, the Value parameter is one of the most important parameters for a point.

Level & Temp Parameters

The Level & Temp parameters indicate the real-time tank level and temperature of the tank gauge point. There are many Software Blocks available in the Tank Gate Interface associated with tank gauge communications, including Software Blocks for every major tank gauge manufacturer.

4.3 Gathering Point Data

For Host to Tank Gate Interface communications, there are two primary methods for gathering point data. These methods are listed below:

4.3.1 Standard Request-Response Format

The Host issues scan requests, and the Tank Gate Interface responds with the data.

The Scan method has the advantage of being deterministic, the response time to a particular request will always be the same.

This method has the limitation that if there are many points defined in the Tank Gate Interface, it often takes several requests to obtain all of the data. Most of the time data has not changed since the last request, so this results in inefficiencies in update times. This situation is often the case in systems where there are many digital points that do not change frequently.

4.3.2 Change of State Format

The Host issues scan requests based on a Change of State condition. Some systems refer to this as Event Mode. The Tank Gate Interface keeps track of the items that have changed since the last Host request. The Host can issue a single request of 'tell me what has changed since my last request.' The Tank Gate Interface will respond with the results, which include addressing information about the data. In a typical system, this results in a significant improvement in the throughput rate for data.

When FuelsManager is the Host system, the Change of State method has the advantage of being very efficient. Only the data that has changed is reported. Change of State is not available when using Modbus.

4.3.3 Change of State-Related Parameters

In order to support the Change of State method, many points have additional configuration parameters included.

Parameter	Description
Value	One of the parameters which will be returned to a Change of State request by the Host. Most Software Blocks are designed so that the Value parameter is the main parameter of interest.
Report	Is used for Change of State processing only Causes automatic notification to the Host (in response to a Change of State Request) when the Value Changes State. Valid values are High, Low or No. Report = No disables notification. Points with Report = High have higher priority than points with Report = Low.
Maxtime	Is used for Change of State processing only Specifies the maximum time (in secs) between automatic Change of State data being sent to the Host in response to a Change of State Request. When the Maxtime period expires, the Value to is forced appear as if it has changed even if it has not, ensuring that data is sent to the host periodically. Setting Maxtime to 0 disables this option. The maximum is 255 seconds.
Deadband LevelDeadband TempDeadband	Affects the Change of State processing. It allows users to filter out insignificant changes, freeing the communications link to send other data.

Note Not all Host protocols support the Change of State method. The RTU Slave protocol used with FuelsManager supports either method.

Note The Modbus protocol is Scan-based. Therefore, the Report and Maxtime parameters have no meaning.

4.3.4 Modbus Communications

Some versions of the Tank Gate Interface are capable of communicating with Modbus compatible devices with both Modbus Masters and Slave devices. The Tank Gate Interface is flexible, allowing communications with devices that strictly comply with the Modicon Modbus protocol, as well as devices with more advanced Modbus implementations such as Honeywell's APM-SIO.

The Modbus Slave protocol handler responds to read and write requests from a Modbus master system. A detailed description of the Modbus Slave protocol handlers follows.

Modbus Slave

The Modbus Slave protocol handler is enabled by setting the Protocol parameter of a COM point to Modbus Slave. COM 0 of the Tank Gate Interface is auto sensing. If a Modbus Master requests data from the Tank Gate Interface, the Tank Gate Interface will automatically detect that Modbus is being used and invoke the Modbus Slave protocol handler. The Modbus Slave protocol handler responds to requests from Modbus masters. A MODGW point is automatically created to provide user access to the operation of the protocol handler. The MODGW point also provides dynamic information about the communications requests from the Modbus master.

The Modbus Slave protocol handler is flexible, allowing the user to set options for handling several aspects of Modbus communications. The Modbus Slave uses the GWBLK Gateway Block as a lookup table for data addresses.

The Gateway Block allows the user to specify data address and point reference combinations. This allows the Tank Gate Interface to be used with an existing system that is already configured. The user defines a GWBLK point and specifies which parameter in the Tank Gate Interface will be used for a particular address. When a request from a master is received, the Modbus Slave protocol handler will first search for any GWBLK points and determine if the data address of the request is specified in one of the GWBLK points. If the data address is contained in a GWBLK point, then the corresponding point reference is used to provide the data for the reply to the master.

COM 0 will automatically sense whether the host system is ViewRTU or a Modbus Master. The communications parameters for COM 0 are 9600 baud, 8 data bits and No Parity. When switching between ViewRTU and Modbus communications, it is necessary to wait 60 seconds for the current protocol to time-out. The Tank Gate Interface will go back to the auto sensing mode and wait for a request. When a request is received, the Tank Gate Interface will determine if the request is from ViewRTU or a Modbus Master. If the Tank Gate Interface has problems switching, press the Reset button and this will force the Tank Gate Interface back into the auto sensing mode.

Note COM 1 (if available) is always a Modbus Slave. The communications parameters for COM 1 are 9600 baud, 8 data bits and No Parity. COM1 is not available on the 8315 Tank Gate Interface

Note The Tank Gate Interface uses the ID switch in determining to which address on the communications bus to respond.

Tank Gate Interface responds to the following Function Codes:

Function Code	Description	Comments
3	Read Output Register	FC 3 and FC 4 are treated the same. Use either FC 3 or FC 4 to read data from the Tank Gate Interface
4	Read Input Register	
5	Force Single Output Status	FC 4 and FC 6 are treated the same. Use either FC 5 or FC 6 to write data to the Tank Gate Interface
6	Preset Single Register	
15	Force Multiple Outputs	FC 15 and FC 16 are treated the same. Use either FC 15 or FC 16 to write multiple registers to the Tank Gate Interface
16	Preset Multiple Registers	

There are two methods for data addressing within the Tank Gate Interface

- The Tank Gate Interface has a fixed Modbus Map of selected parameters
- Gateway Block (GWBLK) software blocks can be configured to set the data address

4.3.5 Fixed Modbus Map

For each version of the Tank Gate Interface, there is a fixed map of data registers. A partial example is shown below:

Address	Type	Number	Parameter	Data Type
5000	MSTX	0	Command	CODED
5001	MSTX	0	Level	REAL
5003	MSTX	0	Temp	REAL
5005	MSTX	0	Value	REAL
5007	MSTX	0	Status	HEX
5008	MSTX	0	PntStatus	IHEX
5009	MSTX	0	Elapse	TIME
5011	MSTX	1	Command	CODED
5012	MSTX	1	Level	REAL
5014	MSTX	1	Temp	REAL
5016	MSTX	1	Value	REAL
5018	MSTX	1	Status	HEX
5019	MSTX	1	PntStatus	IHEX
5020	MSTX	1	Elapse	TIME

Table 4-1: Fixed map of data registers

4.3.6 GWBLK method

The GWBLK is the preferred means to address data in the Tank Gate Interface. The GWBLK has a great deal of flexibility. Data can be scaled, or grouped using the GWBLK. The Gateway Block (GWBLK) allows the user to specify data address and point reference combinations. This allows the Tank Gate Interface to be used with an existing system that is already configured. The Tank Gate Interface can be tailored to meet the needs of the Host. In some cases, the Host system may have some constraints in the use of its Modbus scanner that make it necessary to use a GWBLK. In this mode, the user defines a GWBLK point and specifies which database parameter will correspond to a particular data address. When a request from a master is received, the Modbus Slave protocol handler will first search for any GWBLK points and determine if the data address of the request is specified in one of the GWBLK points. If the data address is contained in a GWBLK point, then the corresponding point reference is used to provide the data for the reply to the master. If the data address is not in any GWBLK point, then data will be read using the prevailing Address Mode.

The Gateway Block (GWBLK) allows the user to specify data address and point reference combinations. The GWBLK acts as a lookup table for data items in the Tank Gate Interface. The user defines a GWBLK point and specifies which database parameter will correspond to a particular data address. When a request from a master is received, the Modbus Slave protocol handler will search for any GWBLK points and determine if the data address of the request is specified in one of the GWBLK points. If the data address is contained in a GWBLK point, then the corresponding point reference is used to provide the data for the reply to the master.

The procedure for using the GWBLK is given below:

- Add a GWBLK point. Depending upon the addressing requirements of the host system, it may be necessary to add additional GWBLKs.
- Configure the GWBLK by setting the Address, PntRef and Size parameters to the parameters of interest in the Tank Gate Interface. Refer to the following examples:

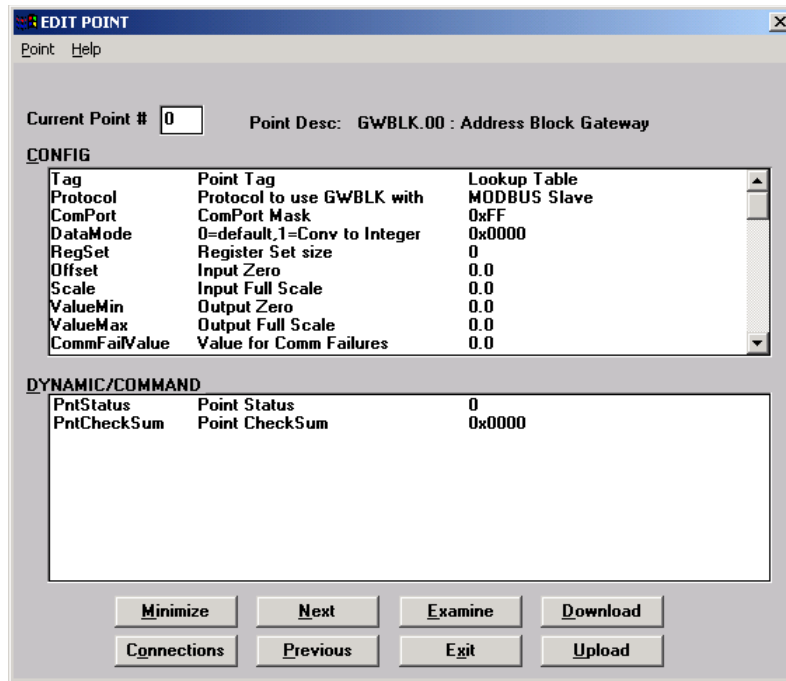

Figure 4-2: Adding a GWBLK point in View RTU

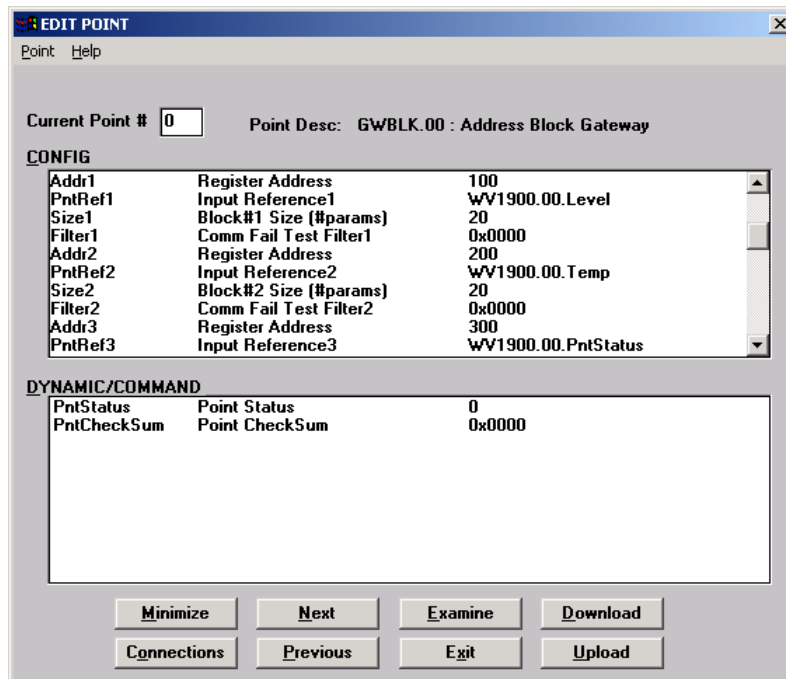

Figure 4-3: Configure the GWBLK in View RTU

In this example, the Modbus register map is configured according to the following table:

Data Address	Parameter	Comments
100-101	MSTX.00.Level	Level is in IEEE Floating point format.
102-103	MSTX.01.Level	
104-105	MSTX.02.Level	
.	.	
138-139	MSTX.19.Level	
200-201	MSTX.00.Temp	Temperature is in IEEE Floating Point Format.
202-203	MSTX.01.Temp	
204-205	MSTX.02.Temp	
.	.	
238-239	MSTX.19.Temp	
300	MSTX.00.PntStatus	PntStatus is in Integer format.
301	MSTX.01.PntStatus	
302	MSTX.02.PntStatus	
.	.	
.319	.MSTX.19.PntStatus	

Table 4-2: Example Modbus register map

4.4 Common Software Blocks

This section describes Software Blocks included with the base unit of the 8310 TGI.

4.4.1 Clock (CLK)



The Clock point provides access to the System Clock. Standard time format is in the form of MM/DD/YY HH:MM:SS.

Parameters

The database parameters used by the CLK point are listed and described below:

Configuration Parameters	Function
TZ	Time Zone string

Dynamic Parameters	Function
SysTime	System Time in the form MM/DD/YY HH:MM:SS. Writing to this value will change the system time
SysTicks	Time in "ticks" format. Ticks are incremented every 10 msec, with the initial value of 0 equal to Jan. 1, 1970 at 00:00:00.
timezone	Time zone relative to GMT. The timezone is entered in seconds. Example: Eastern Time Zone = 18000; Pacific = 28800
daylight	Daylight Saving Flag

4.4.2 Communications (COM)



The Communications point reports the status and controls the operation of the communications interfaces. COM points are automatically created by the system at initialization.

Parameters

The database parameters used by the COM point are listed and described below:

Configuration Parameters	Function
Protocol	Protocol handler assigned to the ComPort. Valid values are: Disabled RTU Slave Modbus Slave TSU Slave The defaults are: COM 0: RTU Slave – 9600 Baud COM 1: Modbus Slave– 9600 Baud
Mode	The Mode parameter is used in conjunction with the Protocol. Different protocols will use the Mode in different ways, depending on the needs of the protocol.
ComPort	Communications Port number. Valid values are 0–3. You should never modify the ComPort parameter.

Configuration Parameters	Function
BaudRate	Baud Rate for communications to either the Host or Slave system. Valid values are: 1200, 2400, 2400, 9600, 19200. Changing the BaudRate parameter will immediately change the configuration of the ComPort. The default is 9600.
ComParams	Defines the number of data bits and the parity used by the com port. Examples include: 8O – 8 Data Bits Odd Parity 8E – 8 Data Bits, Even Parity 8N – 8 Data Bits, No Parity 7O – 7 Data Bits, Odd Parity 7E – 7 Data Bits, Even Parity 7N – 7 Data Bits, No Parity TI – TIWAY The default is '8N'.
TimeOut	Time in seconds that indicates a time-out of communications. If no Host or Slave communications is received for the length of time specified by the TimeOut, the CommStatus parameter will indicate Off Line and communications failure processing will take place.
ErrCheck	Error checking used by the protocol. Valid values are: LRC – Longitudinal Redundancy Check CRC – Cyclical Redundancy Check
RespDelay	Time in milliseconds for which the 8303 TGI will delay a response to the Host. The default is 50 msec.
SynchMax	The SynchMax is used by some slave protocols for autosynchronization of the BaudRate. The SynchMax is used to determine if the BaudRate is correct. If the SynchMax is zero, then no synchronization is attempted.
DirectPort	The DirectPort is used then the Protocol is set to Direct.

Dynamic Parameters	Function
CommStatus	Coded variable indicating the On-line/Offline status of the COM point.
State	Current state of the message being sent/received.
Command	Current command being processed.
Status	Status if the last message.
CommErrors	The number of communication errors.
NumTrans	The number of transactions.
Elapse	Time of the last Change of State.
PntChecksum	CRC-16 Checksum of point's static Configuration Parameters.

Application

The COM point controls the operation of Host and Slave communications. The Baud Rate, Communications Parameters and Protocol may be changed by assigning values to the appropriate parameter. Each Com port is independent of the other and completely flexible in its use.

For example, you may configure the system to communicate with a single host redundantly using the same protocol. Alternatively, the 8300 series Tank Gate Interface can communicate to different hosts using different protocols, allowing the 8300 series Tank Gate Interface to act as a bridge. Other options include assigning one COM point to communicate with a Slave device while communicating to a Host system on the other.

4.4.3 Floating Point Register (FPREG)



The Floating Register point provides four bytes of storage in IEEE floating point format. It is often used for inter-point communications where no other means is provided.

Parameters

The database parameters used by the FPREG point are listed and described below:

Configuration Parameters	Function
Tag	Point tag

Dynamic Parameters	Function
Value1 through Value50	Real (4 bytes) value
PntStatus	Integer HEX value indicating status of point. Values are: 0x0001: Gauge Not Responding. The first time the gauge does not respond, the 0x8000 bit is set. On the second try, the 0x01 bit is set. 0x0002: Data Invalid (General Data Error) 0x0004: Bad Level 0x0008: Temp OverRange 0x0010: Temp UnderRange 0x0020: A/D Error 0x0040: Filtering Level 0x0800: Filtering Temp
Elapse	Time of the last Change of State.
PntChecksum	CRC-16 Checksum for point's static Configuration Parameters.

4.4.4 Emulator (EMU)



The Emulator point allows the to emulate a Whessoe-Varec Model 6820 Tank Scanning Unit (TSU). This point provides access for level, temperature data, and gauge status information from any type of tank gauge interface supported by the 8203 Dual RS-485 Communications Interface Module.

Parameters

The database parameters used by the EMU point are listed and described below:

Configuration Parameters	Function
Tag	The point description can contain 30 bytes of data and can include any printable ASCII character. Descriptions can be used as information relevant to any aspect of the point, such as its use, location, operating information, etc. The default description is set to "EMU.00".
LevelUnits	Specifies the engineering units for the level data. F: feet, m: Millimeters M: Meters I: Inches P: ft-in-16ths The LevelUnits need to match the units specified during the gauge setup.

Configuration Parameters	Function
TempUnits	Specifies the engineering units for the temperature data. TempUnitsSpecifies the engineering units for the temperature data. F: Fahrenheit C: Celsius The TempUnits needs to match the units specified during the gauge setup.
DensityUnits	Specifies the engineering units for the density data. DensityUnitsSpecifies the engineering units for the density data. K: kg/m ³ A: API L=lbs/cu ft The DensityUnits needs to match the units specified during the gauge setup.
Offset	Specifies the offset to the first address.
PntRef1 – 20	Input point reference for the EMU point to monitor. The PntRef parameter is set to the Level parameter for the tank gauge point. The temperature will be read at the same time as the level. The EMU point interfaces tank gauge interface points: WV1900 – Whessoe–Varec Model 1900

Dynamic Parameters	Function
PntStatus	Byte value indicating status of point Values are: Dynamic ParametersFunction PntStatusByte value indicating status of point Values are: 0: No error 15: Invalid Type for PntRef 16 Invalid Number for PntRef 17 Invalid Param for PntRef 19: PntRef point does not exist 25: PntRef is not defined
PntChecksum	CRC–16 Checksum for point's static Configuration parameters.

Application

The Emulator point (EMU) provides a communication interface between older tank gauging system and point blocks within the 8203 Dual RS–485 Communications Interface Module . Currently, the 8203 Dual RS–485 Communications Interface Module can emulate a Whessoe Varec Model 6810 Tank Scanning Unit (TSU).

The EMU point associates a tank gauge point with an address to be used by TankView. EMU.0 provides point references for TankView System Addresses 1–50. EMU.1 is associated with System Addresses 51–100. A EMUGW gateway point is automatically created when the protocol for a COM point is set to TSU Slave.

4.4.5 EMU Gateway (EMUGW)



The EMU Gateway point is used to manage scanning functions for the EMU point. Statistics are maintained for the communications between the Series 8130 and the tank gauging software (TankView or System IV). Special firmware is required on the 8203 Dual RS-485 Communications Interface Module to support the emulation functions.

Parameters

The database parameters used by the EMUGW point are listed and described below:

Configuration Parameters	Function
Protocol	Protocol to emulate. Valid values are: TSU Slave
ID	Address to respond to
Mode	Operational Mode
BaudRate	Baud Rate used to communicate with TankView
ComParams	Defines the number of data bits and the parity used by the com port. Examples include: ID: Address to respond to Mode: Operational Mode BaudRate: Baud Rate used to communicate with TankView ComParams Defines the number of data bits and the parity used by the com port. Examples include: 8O – 8 Data Bits Odd Parity 8E – 8 Data Bits, Even Parity 8N – 8 Data Bits, No Parity 7O – 7 Data Bits, Odd Parity 7E – 7 Data Bits, Even Parity 7N – 7 Data Bits, No Parity The default is '8N'.
LevelConvert	Determines the units in which the level data will be displayed. F: feet, M: Millimeters. If no value is specified, no conversion will be performed.
TempConvert	Determines the units in which the temperature data will be displayed. F: Fahrenheit, C: Celsius. If no value is specified, no conversion will be performed.
DensityConvert	Determines the units in which the density data will be displayed. A: API, L: lbs/cu ft, K: kgs/m ³ . If no value is specified, no conversion will be performed.

Dynamic Parameters	Function
Message	Hex representation of the request sent by the host
Command	Current Command
Addr	Displays the tank number of the currently selected tank.

Dynamic Parameters	Function
LevelRef	The reference point for level and temperature data for the tank currently requested by TankView
Flags	Hex value representing the operational status
NumRequests	Number of requests from TankView or Entis
NumComErrors	Number of errors
Elaspe	Time of last request
PntChecksum	CRC-16 Checksum for point's static Configuration Parameters.

Application

The EMUGW point is automatically created when the TankView (TSU Slave) protocol is initiated. In order to use the TSU Slave protocol, set the Protocol parameter of the COM point to TSU Slave. At that time, an EMUGW and an EMU point will be created to provide a user interface for configuration and control of communications with TankView or System IV. The baud rate and data link parameters are set in the COM point as well. The default is 9600, 8 data bits, No parity.

The EMUGW point keeps track of the number of requests and number of errors associated with the EMU Slave protocol. The current tank number (ID) and the point associated with the tank number (LevelRef) are updated as requests from TankView are processed. The PntRefs correlate to the SYS ADR parameter in TankView or IDs in System IV.

4.4.6 Gateway Block (GWBLK)



The Gateway Block point is used for compatibility with Modbus Master devices. Rather, you configure a GWBLK to function as a look-up table. The GWBLK point lets you specify which point references will respond to data addresses in the request from a Host. The GWBLK point contains a cross-reference table for database parameters and data addresses.

Parameters

The database parameters used by the GWBLK point are listed and described below:

Configuration Parameters	Function
Tag	A Tag can contain 15 bytes of data and can include any printable ASCII character. Tags can be used to identify points indicating the use of the point such as "Modbus Slave" or "Register Value1." The default tag is set to "GWBLK.00".
Protocol	Protocol that the GWBLK point is used with. Valid values are: Modbus Slave
ComPort	Bit mask to enable address referencing. If a bit corresponding to the com port, then address referencing is enabled for the channel. The default is 0xFF (all COM ports).

Configuration Parameters	Function
DataMode	Integer HEX value that controls the data returned to a Modbus Host 0: Use parameter values 0x01: Convert to Integer 0x02: Return 0xFF if the data is invalid. 0x04: Convert to Integer using only the Scale If the DataMode is 0x01, the PntRef data will be converted to an integer using the Offset, Scale, ValueMin and ValueMax. If the DataMode is 0x04, the Scale parameter is used to convert to an integer.
RegSet	Register Set size
Offset	Input range Offset used for scaling the output to an integer value when DataMode=1.
Scale	Input range Scale used for scaling the output to an integer value when DataMode=1.
ValueMin	Output range Offset used for scaling the output to an integer value when DataMode=1.
ValueMax	Output range Scale used for scaling the output to an integer value when DataMode=1.
CommFailValue	Value to set all of the output registers to when there is a communications or other failure. The CommFailValue works in conjunction with the Filter values. If the PntStatus of the PntRef has bits set that match the Filter, the reference value is declared invalid and the output value will be set to the CommFailValue. This mode is overridden by DataMode = 0x02.
Addr1-10 PntRef1-10 Size1-10 Filter1-10	Addr1 is the Data Address and PntRef1 is the corresponding database parameter that will be used for a response. The default Size is 1. See the discussion below for more detail on the Size parameter. The Filter is used to determine if the data is valid. The PntStatus of the point specified by the PntRef is read and if there are bits set that match the Filter, the source data is considered invalid. The output registers will be set to the value determined by the CommFailValue.
Dynamic Parameters	Function
PntStatus	Byte value indicating status of point Values are: 0: No error
pntChecksum	CRC-16 Checksum of point's static Configuration Parameters

Application

The GWBLK point is a look-up table used by the Modbus Slave protocol handler. Up to sixteen address-point reference pairs may be used per GWBLK point. Multiple GWBLK points may be used if necessary. The Addr parameter specifies the data address. The corresponding PntRef parameter specifies the database parameter for the request. The Gateway Block point allows you to use the 8300 series Tank Gate Interface easily in retrofit applications. It is not necessary to re-configure an existing HMI or Host system. You can configure the 8300 series Tank Gate Interface to match the addresses used in the Host system.

When the Modbus Slave protocol handler receives a request, it searches the GWBLK points to determine if any of the Addr parameters match the request. If a match is found, the data referenced by the PntRef parameter will be used for the response.

There are three data modes: DataMode=0, which returns the data in the default format, and DataMode=1, which returns the data in an integer format. DataMode=1 will scale IEEE floating point data to an integer value, using the Offset, Scale, ValueMin and ValueMax parameters. If DataMode = 4, the data will be scaled to an integer by multiplying the data value times the Scale parameter.

The DataMode can also control if the data is changed to 0xFFFF if the data is invalid. The Filter parameter is compared to the PntStatus of the PntRef parameter. If bits in the PntStatus match bits in the Filter, the data is considered invalid and the a read from a modbus host will result in the data being set to 0xFFFF.

When Block Read or Write requests are received, then the way in which the Modbus Slave protocol handler responds is determined by the Size parameter.

Size Parameter

A range of addresses can be specified by setting the Size parameter. This sets the indexing mode to Number Indexing, which means that Block Read/Write requests from the Hosts are handled by stepping through the points number by number. For example, if Addr1 is 100, and PntRef1 is MSTX.00.RawValue, then a Block Read to address 100 with a length of 8 will return the values, MSTX.00.RawValue, MSTX.01.RawValue, ... MSTX.07.RawValue. Setting the Size to 1 does not limit the read to 1 parameter, rather it indicates that block operations will be processed by stepping through points by incrementing the number, starting with parameter specified by the PntRef.

4.4.7 Integer Register (IREG)



The Integer Register point provides two bytes of storage. It is often used for inter-point communications where no other means is provided.

Parameters

The database parameters used by the IREG point are listed and described below:

Configuration Parameters	Function
Tag	A Tag can contain 15 bytes of data and can include any printable ASCII character. Tags can be used to identify points indicating the use of the point.

Dynamic Parameters	Function
Value	Integer (2 bytes) value

4.4.8 Modbus Gateway (MODGW)



The Modbus Gateway provides dynamic and statistical information for the communications between the 8300 series Tank Gate Interface and the Modbus masters.

Parameters

The database parameters used by the MODGW point are listed and described below:

Configuration Parameters	Function
ID	Slave Address that the Modbus Slave protocol handler will respond to. The default is to match the Unit Address of the 8300 series Tank Gate Interface.
Mode	Operational Mode. The Mode is a hex value, with individual bits controlling various aspects of the operation of the Modbus Slave protocol handler. The bits have the following meanings: 0x01 – Set Param Indexing mode 0x02 – Integer Swap mode 0x04 – Swap CRC bytes 0x08 – ASCII mode 0x20 – Wonderware Mode 0x80 – Ignore any trailing nulls in the request The default is 0.
BaudRate	Baud Rate for communications to the Host system. Valid values are: 1200, 2400, 2400, 9600 and 19200. Changing the BaudRate parameter will immediately change the configuration of the ComPort.
ComParams	Defines the number of data bits and the parity used by the com port. Valid values include: 8N – 8 data bits, No parity 8O – 8 data bits, Odd parity 8E – 8 data bits, Even parity 7O – 7 data bits, Odd parity 7E – 7 data bits, Even parity The default is '8N'.
DetectTime	Modbus RTU Mode character timer (in 1/100s of a second).

Dynamic Parameters	Function
Message	Current request message, displayed in hex format.
Command	Current command. Values include: 1 – Read Output Status 2 – Read Input Status 3 – Read Output Registers 4 – Read Input Registers 5 – Force Single Coil 6 – Preset Single Register 15 – Force Multiple Coils 16 – Preset Multiple Registers
Addr	Data Address for current request.
Elapse	Time of the last request from the master
PntChecksum	CRC-16 Checksum of point's static Configuration Parameters

Application

The MODGW point provides status information for the communications with any Modbus masters used with the 8300 series Tank Gate Interface. On the 8300 series Tank Gate Interface Motherboard, the MODGW point is created automatically whenever the Modbus Slave protocol is defined for a COM point. The point number created will correspond to the ComPort such that MODGW.1 is created for COM 1. Use the Upload command from the Config Menu to retrieve the data from the MODGW point or any other points created automatically by the RTU.

The MODGW point provides information about the current command and data address requested by the Modbus master system. The MODGW provides assurance that requests are being received and processed.

4.4.9 Scaler Point (SCALER)



The Generic Scaling point allows you to perform math functions in the 8300 series Tank Gate Interface. The SCALER point monitors one or more database reference values and performs an equation in the form:

$$\text{Value} = Ax + By + Cz + K$$

Note A, B, C & K are user-entered constants.

Note x, y & z are inputs from other database points.

Parameters

The database parameters used by the SCALER point are listed and described below:

Configuration Parameters	Function
Tag	A Tag can contain 15 bytes of data and can include any printable ASCII character. Tags can be used to identify points indicating the use of the point such as "Eng Converter". The default tag is set to "SCALER.00".
PntRef1 PntRef2 PntRef3	The PntRef parameters determine the input source for the SCALER point to monitor. Up to three references may be specified. RefValue1 is the X term, PntRef2 is the Y term, and PntRef3 is the Z term. If a reference is not specified, then it is not used in the equation.
A	Constant that is multiplied with RefValue1
B	Constant that is multiplied with RefValue2
C	Constant that is multiplied with RefValue3
K	Constant K
Deadband	Change of State deadband
Report	Causes automatic notification to the Host (in response to a Change of State Request) when the Value changes State. Parameter value can be High, Low or No. Report=No disables notification. Points with Report = High will be sent before points with Report = Low. The default is No.
Maxtime	Specifies the maximum time (in secs) between automatic Change of State responses being sent to the Host. Report must be set to either Low or High for the Value parameter to be sent in response to a Change of State Request. A value of 0 disables this option. Non-zero values cause responses to be sent although the value may have not changed since the last message. The default is 60.

Dynamic Parameters	Function
Value	Output value for the SCALER point. Value = Ax + By + Cz + K. x corresponds the RefValue1, y is RefValue2, and z is RefValue3.
RefValue1 RefValue2 RefValue3	RefValue1 - 3 are the values of the PntRef1 - 3 parameter references. The references can be to any point that produces a floating point value.
Value1	Value parameter converted to Integer format

Dynamic Parameters	Function
PntStatus	Byte value indicating status of point Values are: 0: No error 15: Invalid Type for PntRef 16 Invalid Number for PntRef 17 Invalid Param for PntRef 19: PntRef point does not exist 25: PntRef is not defined
Elapse	Time the SCALER point last executed.
PntCheckSum	CRC-16 Checksum of point's static Configuration Parameters

Application

The SCALER point allows you to perform simple math functions such as conversion of units. The SCALER point takes the value from user-specified database references, multiplies each by a constant and adds the three product terms. A constant K may also be factored in. The SCALER point works in conjunction with parameters that are in floating point format.

4.4.10 System Information (SYS)



The System Information Point lists the hardware and software specifications of the system. Other information includes the hardware version and any connected devices.

Parameters

The database parameters used by the SYS point are listed and described below:

Configuration Parameters	Function
RTUTag	RTUTag can contain 15 bytes of data and can include any printable ASCII character.
DBFile	The database file name. DBFile is the name of the RCF database configuration file
DBVer	The database version.
PntEnable	Disable/Enable execution of points. Default is Enable.

Dynamic Parameters	Function
UnitAddr	The Unit Address (SW1) for the 8300 series Tank Gate Interface.
DBPnts	The number of database points defined.
DBSize	The size of the database in bytes.
DBChangeTime	The time of last database modification.
SysVer	The firmware version.
SysCheckSum	The system checksum.
HardVer	The PCB hardware version.
PSDVer	The programmable logic version.
PntCheckSum	CRC-16 Checksum for point's static Configuration Parameters.

5 Varec Mark/Space Software Blocks

This chapter describes the Software Blocks that are included in the 8310 Tank Gate Interface (Varec Mark/Space), excluding those common to all the 8300 TGI software versions. The Software Blocks are listed in alphabetical order by acronym.

Common Software Blocks are described in section 4.4 on page 31.

5.1 Gauging Systems Inc. Model 2000 Mark/Space Interface (GS2000)



The GS2000 point provides an interface to GSI 2000 Mark/Space Tank Gauge transmitters. This point provides both level and temperature data. Point and gauge status information is also available in this point block. This Software Block executes on the 8310 Tank Gate Interface.

5.1.1 Parameters

The database parameters used by the GS2000 point are listed and described below:

Configuration Parameters	Function
Tag	The point description can contain 30 bytes of data and can include any printable ASCII character. Descriptions can be used as information relevant to any aspect of the point, such as its use, location, operating information, etc. The default description is set to "GS200.00".
Description	The point description can contain 30 bytes of data and can include any printable ASCII character. Descriptions can be used as information relevant to any aspect of the point, such as its use, location, operating information, etc. The default description is set to "GS200.00".
FastScanMode	Places the GS2000 point in the Fast Scan mode. Values are Enable or Disable.
ID	Physical Address of the tank gauge transmitter (0-999).
Module	Not used.
SpeedMode	Allows user to set the speed mode. Selections include High, Low or Undefined.
DataMode	Data format of the transmitter encoder. Values are: 0: Fractional 1: Decimal 2: Metric 0-20 meter 3: Metric 0-30 meter
LevelDeadband	Specifies the amount of change in the Level that must occur for the Value to be updated each Change of State period. The default is 0.
LevelOffset	Specifies the amount of offset to add to the Level. The default is 0.
TempMode	Allows the user to enable or disable the temperature mode or specify the temperature format. Values are: F: Fahrenheit (Model 1900 Emulator) C: Celsius (Model 1900 Emulator) 3: Fahrenheit (Model 1800 Emulator) 4: Celsius (Model 1800 Emulator) 5: Fahrenheit (Model 1800 Emulator) 6: Celsius (Model 1800 Emulator) U: Undefined - Assumes transmitter does not support temperature.
TempDeadband	Specifies the amount of change in the Temp that must occur for the Value to be updated each Change of State period. The default is 0.25.
TempOffset	Specifies the amount of offset to add to the Temp. The default is 0.
Report	Causes automatic notification to the Host (in response to a Change of State Request) when the Value changes State. Parameter value can be High, Low or No. Report=No disables notification. Points with Report = High will be sent before points with Report = Low. The default is High.

Configuration Parameters	Function
Maxtime	Specifies the maximum time (in secs) between automatic Change of State responses being sent to the Host. Report must be set to either Low or High for the Value parameter to be sent in response to a Change of State Request. A value of 0 disables this option. Non-zero values cause responses to be sent even if the value has not changed since the last message. The default is 600.

Dynamic Parameters	Function
Level	Floating point value representing the tank level. The Level will be presented in decimal feet or meters, depending upon the LevelConvert parameter of the MSSCAN point.
Temp	Floating point value representing the tank temperature. The Temperature will be presented in Fahrenheit or Celsius, depending upon the TempConvert parameter of the MSSCAN point
Alarm	Gauge Alarms. Not used for the GS2000 point.
PntStatus	Integer HEX value indicating status of point. Values are: 0x0001: Gauge Not Responding. The first time the gauge does not respond, the 0x08 bit is set. On the second try, the 0x01 bit is set. 0x0002: Parity Error on last scan 0x0004: Data from the Gauge is Not Valid 0x0008: Timeout Error. The Motherboard monitors the Elapse parameter. If data is not being updated (due to the 8210 malfunctioning), the 0x08 bit will be set. 0x0010: Gauge did not respond on last scan (pre-fail) 0x0020: Invalid Level 0x0040: Large change in Level or Temperature 0x0800: Mark Line shorted to ground 0x0400: Space Line shorted to ground 0x0200: Blown Fuse 0x0100: No +48 VDC
GaugeStatus	Byte value indicating status of the gauge. Refer to the transmitter manual for details on the GaugeStatus
Elapse	Time of the last Change of State
Interval	This parameter displays the number of hours:minutes:seconds since the point was last updated.
Raw1	Raw data from gauge. Value reported as hexadecimal value.
Raw2	Raw data from gauge. Value reported as hexadecimal value.

Application

The GS2000 point provides an interface to GSI Model 2000 Tank Gauge Transmitters. Tank gauges are connected directly to a Tank Gate Interface.

At startup, a MSSCAN point is automatically created to manage the scanning task. The ID must match the unit address of the GSI Model 2000.

The SpeedMode must match the configuration of the transmitter. The DataMode must match the engineering units of the gauge. Conversion from Metric to English (or viceversa) can be performed by setting the LevelConvert and the TempConvert parameters in the MSSCAN point associated with the GS2000 point.

The Level can be offset by entering a value for the LevelOffset parameter. The LevelOffset is added to the Level after any conversion have be performed. Likewise, the TempOffset may be used to offset the Temp value.

The FastScanMode parameter places the point in the Fast Scan list. Fast Scan points are scanned more frequently than other points. The Interleave, FastScanMax, and FastScanTime parameters of the MSSCAN point determine how fast scanning is performed.

5.2 Varec Mark Space Servo Gauge (MSSTG)



The MSSTG point provides an interface to Whessoe Varec 6500 Tank Gauge transmitters as well as a Varec 6000 servo gauge emulating Mark Space communications. This point provides both level and temperature data. Point and gauge status information is also available in this point block.

5.2.1 ParametersW

The database parameters used by the MSSTG point are listed and described below:

Configuration Parameters	Function
Tag	A Tag can contain 15 bytes of data and can include any printable ASCII character. Tags can be used to identify points indicating the use of the point such as, Modbus Slave or Register Value1. The default tag is set to MSSTG.00.
Description	The point description can contain 30 bytes of data and can include any printable ASCII character. Descriptions can be used as information relevant to any aspect of the point, such as its use, location, operating information, etc. The default description is set to "MSSTG.00".
FastScanMode	Places the MSSTG point in the Fast Scan mode. Values are Enable or Disable. The default value is Disable.
ID	Physical Address of the tank gauge transmitter (0-999).
Module	Not used.
SpeedMode	Allows you to set the speed mode. Selections include High, Low or Undefined.
DataMode	Data format of the transmitter encoder. Values are: 0: Fractional 1: Decimal 2: Metric 0-20 meter 3: Metric 0-30 meter
LevelDeadband	Specifies the amount of change in the Level that must occur for the Value to be updated each Change of State period. The default is 0.
LevelOffset	Specifies the amount of offset to add to the Level. The default is 0.
TempMode	Allows you to enable or disable the temperature mode or specify the temperature format. Values are: F: Fahrenheit C: Celsius
TempDeadband	Specifies the amount of change in the temperature that must occur for the Value to be updated each Change of State period. The default is 0.25.
TempOffset	Specifies the amount of offset to add to the temperature. The default is 0.

Configuration Parameters	Function
Report	Causes automatic notification to the Host (in response to a Change of State Request) when the Value changes State. Parameter value can be High, Low or No. Report=No disables notification. Points with Report = High will be sent before points with Report = Low. The default is High.
Maxtime	Specifies the maximum time (in secs) between automatic Change of State responses being sent to the Host. Report must be set to either Low or High for the Value parameter to be sent in response to a Change of State Request. A value of 0 disables this option. Non-zero values cause responses to be sent even if the value has not changed since the last message. The default is 600.

Dynamic Parameters	Function
Command	Command to control the displacer of the Model 6500. Value values include: Raise: Raise the displacer Reset: Return the displacer to follow the level.
CmdStatus	The status of the Command.
Level	Floating point value representing the tank level. The Level will be presented in decimal feet or meters, depending upon the LevelConvert parameter of the MSSCAN point.
Temp	Allows you to enable or disable the temperature mode or specify the temperature format. Values are: F: Fahrenheit C: Celsius
Alarm	Gauge Alarms. Not used for the GS2000 point. Byte value indicating status of option alarm contacts. Values are: 0x01: Alarm 0 0x02: Alarm 1
PntStatus	Integer HEX value indicating status of point. Values are: 0x0001: Gauge Not Responding. The first time the gauge does not respond, the 0x10 bit is set. On the second try, the 0x01 bit is set. 0x0002: Parity Error on last scan 0x0004: Data from the gauge is Not Valid 0x0008: Timeout Error. The Motherboard monitors the Elapse parameter. If data is not being updated (due to the 8210 malfunctioning), the 0x08 bit will be set. 0x0010: Gauge did not respond on last scan (pre-fail) 0x0020: Invalid Level 0x0040: Large change in Level or Temperature 0x0400: Space line Shorted 0x0800: Mark line Shorted 0x0E00: Blown Fuse 0x0F00: No + 48 VDC 0x4000: Failure of the Model 8210. This bit is set if the Watchdog task on the Motherboard determines that the Model 8210 has stopped updating

Dynamic Parameters	Function
GaugeStatus	Byte value indicating status of the gauge. Refer to the transmitter manual for details on the GaugeStatus
Elapse	Time of the last Change of State.
Interval	This parameter displays the number of hours:minutes:seconds since the point was last updated.
PntChecksum	CRC-16 Checksum for point's static Configuration Parameters
Raw1	Raw data from gauge. Value reported as hexadecimal value.
Raw2	Raw data from gauge. Value reported as hexadecimal value.

5.2.2 Application

The MSSTG point provides an interface to Whessoe Varec Model 6500 Tank Gauge Transmitters. Model 6500 Tank gauge transmitters are connected directly to a TankGate. At startup, A MSSCAN point is automatically created to manage the scanning task. The ID must match the unit address of the Model 6500. The SpeedMode must match the configuration of the transmitter. The DataMode must match the engineering units of the gauge. Conversion from Metric to English (or viceversa) can be performed by setting the LevelConvert and the TempConvert parameters in the MSSCAN point associated with the MSSTG point. The Level can be offset by entering a value for the LevelOffset parameter. The LevelOffset is added to the Level after any conversion have been performed. Likewise, the TempOffset may be used to offset the Temp value. The FastScanMode parameter places the point in the Fast Scan list. Fast Scan points are scanned more frequently than other points. The Interleave, FastScanMax, and FastScanTime parameters of the MSSCAN point determine how fast scanning is performed.

5.3 Mark Space Scanner (MSSCAN)



The MSSCAN point is used in conjunction with MSTX, GS2000, and MSSTG gauge points. This point is created automatically to monitor and control the operation of the TankGate. It is not necessary to add a MSSCAN point. This point also provides dynamic and statistical data for the TankGate module and associated tank transmitters.

5.3.1 Parameters

The database parameters used by the MSSCAN point are listed and described below:

Configuration Parameters	Function
Module	8210 Comms Module address
Interleave	Number of Normal Scan points to scan between Fast Scan Cycles. Refer to the Fast Scan discussion below.
FastScanMax	Max number of Fast Scan points to scan each Fast Scan Cycle. Refer to the Fast Scan discussion below.
FastScanTime	Time between Fast Scan Cycles. If 00:00:00 (default), Fast Scan Cycles are determined using the Interleave and FastScanMax parameters. Refer to the Fast Scan discussion below.
Timeout	Value between 0–30000 indicating the number of milliseconds the scanner will wait for a response from a tank transmitter. Default is 150 (150 msec).
MaxRetry	Value between 1–10 indicating the number of times the scanner will attempt to poll a tank transmitter that has not responded. Default is 2.
ScanDelay	Value between 0–30000 indicating the number of milliseconds the scanner will delay between each poll. Default is 50. This value should not be changed.
HoldOff	Value indicating the number of times the scanner will skip attempting to poll a tank transmitter that has not responded. Default is 10.
LevelConvert	Determines the units in which the level data will be displayed. F: feet, M: Meters, m: Millimeters.
TempConvert	Determines the units in which the temperature data will be displayed. F: Fahrenheit, C: Celsius.

Dynamic Parameters	Function
ScanEnable	Allows the user to Enable or Disable scanning
ID	ID of gauge currently being scanned
Pnt	Point currently being executed
NumRequests	Number of gauge polls since last reset
NumComErrors	Number of gauge polls which resulted in an error.

Dynamic Parameters	Function
NumTimeouts	Number of unresponded requests issued before the scanner timed out.
NumScanList	Total number of MSSTG, GS2000 and MSTX points in the scan list
NumFastScan	Number of points in the Fast Scan List
PntStatus	Byte value indicating status of point Values are: 0: No error
PntChecksum	CRC-16 Checksum for point's static Configuration Parameters

5.3.2 Application

The MSSCAN point monitors the status of the protocol or communications module. The MSSCAN point is created automatically after a hard reset by the TankGate. Use ViewRTU's Upload command to retrieve the data from the MSSCAN point or any other points created automatically by the TankGate.

The NumRequests parameter gives the total number of requests attempted, while the NumTimeouts and NumComErrors are the number of time-outs and communications errors. The ID is the current gauge ID being scanned. The Pnt parameter is the Tag of the MSTX, MSSTG or GS2000 point associated with the point being scanned.

This point can set the type of engineering units for the level and temperature data (English or Metric). The value of Level and Temp parameters for the MSTX, MSSTG or GS2000 point depend upon the values of the LevelConvert and TempConvert parameters. The DataMode must match the configuration of the tank gauge transmitter. If the DataMode is incorrect, the Level and Temp will be decoded incorrectly. By setting the LevelConvert and TempConvert the Level and Temp can be changed from English to Metric or vice-versa. If the LevelConvert and TempConvert are not set, no conversion will be performed.

The user can also set the delay between each poll as well as how long the scanner will wait for a transmitter to respond. If a transmitter is not responding, it will not be polled as often as transmitters that are on-line. The HoldOff parameter determines how often the off-line transmitter will be polled. For example, if the HoldOff is 10, then a transmitter that is off-line will be polled only one tenth as often as a transmitter that is online.

Fast Scan

The MSTX, MSSTG and GS2000 points have a parameter called the FastScanMode. Setting FastScanMode to Enable places these points in the Fast Scan List. Points in the Fast Scan list are polled more frequently than points in the Normal Scan List. Scanning tank gauges alternates between points from the Fast Scan List and Normal Scan List. When a Fast Scan Cycle occurs, gauges are read from the Fast Scan List. When a Normal Scan Cycle occurs, gauges are read from the Normal Scan List.

The MSSCAN point provides the ability to control the operation of the Fast Scan List. The MSSCAN point has several parameters that involved:

Parameter	Description
Interleave	Number of points to scan during each Normal Scan Cycle
FastScanMax	Number of points to scan during each Fast Scan Cycle
FastScanTime	If defined, the FastScanTime is used to determine when Fast Scan Cycles are performed

Parameter	Description
NumFastScan	Number of points in the Fast Scan List

The number of gauges scanned during a Fast Scan Cycle is determined by the FastScanMax. If the value is 0, then all MSTX, MSSTG and GS2000 points with the FastScanMode set to Enable will be scanned. If the value is 1, then only a single gauge from the Fast Scan List will be read each time a Fast Scan Cycle is executed.

The Interleave parameter controls the number of gauges read during each Normal Scan Cycle.

Example – Default method, with 1 tank in the Fast Scan List

Interleave = 1, FastScanMax=0, FastScanTime=00:00:00, MSTX.00.FastScanMode = Enable (ID = 1).

(Fast Scan shown in shaded cells)															
1	1	2	1	3	1	4	1	5	1	6	1	7	1	8	...

Example – One tank in the Fast Scan List

Interleave = 3, FastScanMax=0, FastScanTime=00:00:00, MSTX.00.FastScanMode = Enable (ID = 1).

(ID = 1).															
1	2	3	1	4	5	6	1	7	8	9	1	10	11	12	...

Setting the Interleave to 3 results in 3 tanks being read each time a Normal Scan is performed.

Example – Six tanks in the Fast Scan List

Interleave = 3, FastScanMax=2, FastScanTime=00:00:00, MSTX.00.FastScanMode – MSTX.05.FastScanMode = Enable (Ids 1-6)

(Ids 1-6)															
1	2	3	1	2	4	5	6	3	4	7	8	9	5	6	...

Setting the Interleave to 3 results in 3 tanks being read each time a Normal Scan is performed. Setting the FastScanMax to a 2 results in 2 tanks being read each time a Fast Scan is performed.

5.4 Varec Mark Space Level Transmitter (MSTX)



The Varec Mark Space Level Transmitter (MSTX) point provides an interface to various Mark Space transmitters such as the Varec 1800 and 1900, as well as instruments that emulate Mark Space communications such as the 2900 FTT, 4000 ATT, 4100/4200 MFT and 4590 TSM. This point provides both level and temperature data. Point and gauge status information is also available in this point block. This point used to be designated VW1900.

5.4.1 Parameters

The database parameters used by the MSTX point are listed and described below:

Configuration Parameters	Function
Tag	A Tag can contain 15 bytes of data and can include any printable ASCII character. Tags can be used to identify points indicating the use of the point such as, Modbus Slave or Register Value1. The default tag is set to MSTX.00.
Description	The point description can contain 30 bytes of data and can include any printable ASCII character. Descriptions can be used as information relevant to any aspect of the point, such as its use, location, operating information, etc. The default description is set to "MSTX.00".
FastScanMode	Places the MSTX point in the Fast Scan mode. Values are Enable or Disable.
ID	Physical Address of the tank gauge transmitter (0-999).
Module	Not used.
SpeedMode	Allows you to set the speed mode. Selections include High, Low or Undefined.
DataMode	Data format of the transmitter encoder. Values are: 0: Fractional 1: Decimal 2: Metric 0-20 meter 3: Metric 0-30 meter
LevelDeadband	Specifies the amount of change in the Level that must occur for the Value to be updated each Change of State period. The default is 0.
LevelOffset	Specifies the amount of offset to add to the Level. The default is 0.
TempMode	Allows the user to enable or disable the temperature mode or specify the temperature format. Values are: F: Fahrenheit (Model 1900 Type) C: Celsius (Model 1900 Type) 3: Fahrenheit (Model 1800 Type) 4: Celsius (Model 1800 Type) 5: Fahrenheit (Model 1800 Type) 6: Celsius (Model 1800 Type) U: Undefined – Assumes the transmitter does not support temperature. Any other value will assume the transmitter does not support temperature (40 bit Mark/Space message).

Configuration Parameters	Function
TempDeadband	Specifies the amount of change in the Temp that must occur for the Value to be updated each Change of State period. The default is 0.25.
TempOffset	Specifies the amount of offset to add to the Temp. The default is 0.
Report	Causes automatic notification to the Host (in response to a Change of State Request) when the Value changes State. Parameter value can be High, Low or No. Report=No disables notification. Points with Report = High will be sent before points with Report = Low. The default is High.
Maxtime	Specifies the maximum time (in secs) between automatic Change of State responses being sent to the Host. Report must be set to either Low or High for the Value parameter to be sent in response to a Change of State Request. A value of 0 disables this option. Non-zero values cause responses to be sent even if the value has not changed since the last message. The default is 600.

Dynamic Parameters	Function
Level	Floating point value representing the tank level. The Level will be presented in decimal feet or meters, depending upon the LevelConvert parameter of the MSSCAN point.
Temp	Floating point value representing the tank temperature. The Temperature will be presented in Fahrenheit or Celsius, depending upon the TempConvert parameter of the MSSCAN point
Alarm	Byte value indicating status of option alarm contacts. Values are: 0x01: Alarm 0 0x02: Alarm 1
PntStatus	Integer HEX value indicating status of point. Values are: 0x0001: Gauge Not Responding. The first time the gauge does not respond, the 0x10 bit is set. On the second try, the 0x01 bit is set. 0x0002: Parity Error on last scan 0x0004: Data from the Gauge is Not Valid 0x0008: Timeout Error. The Motherboard monitors the Elapse parameter. If data is not being updated (due to the 8210 malfunctioning), the 0x08 bit will be set. 0x0010: Gauge did not respond on last scan (pre-fail) 0x0020: Invalid Level 0x0040: Large change in Level or Temperature 0x0800: Mark Line shorted to ground 0x0400: Space Line shorted to ground 0x0200: Blown Fuse 0x0100: No +48 VDC
GaugeStatus	Byte value indicating status of the gauge. Values are: 0x01: Alarm 0 0x02: Alarm 1 0x10: X400 Temp bit 0x20: X200 Temp bit 0x40: Temp Sign 0x80: X100 Temp bit

Dynamic Parameters	Function
Elapse	Time of the last Change of State.
Interval	This parameter displays the number of hours:minutes:seconds since the point was last updated.
PntChecksum	CRC-16 Checksum for point's static Configuration Parameters
Raw2	Raw data from gauge. Value reported as hexadecimal value.
Raw2	Raw data from gauge. Value reported as hexadecimal value.

5.4.2 Application

The MSTX point provides an interface to various Mark Space transmitters like the Varec 1800 and 1900, as well as instruments that emulate Mark Space communications like the 2900 FTT, 4000 ATT, 4100/4200 MFT and 4590 TSM. Model 1900 Tank gauge transmitters are connected directly to a TankGate. At startup, a MSSCAN point is automatically created to manage the scanning task. The ID must match the unit address of the Model 1900.

The SpeedMode must match the configuration of the transmitter. The DataMode must match the engineering units of the gauge. Conversion from Metric to English (or vice versa) can be performed by setting the LevelConvert and the TempConvert parameters in the MSSCAN point associated with the MSTX point.

The Level can be offset by entering a value for the LevelOffset parameter. The LevelOffset is added to the Level after any conversion have be performed. Likewise, the TempOffset may be used to offset the Temp value.

The FastScanMode parameter places the point in the Fast Scan list. Fast Scan points are scanned more frequently than other points. The Interleave, FastScanMax, and FastScanTime parameters of the MSSCAN point determine how fast scanning is performed.

6 Installation

Before attempting installation, review the Safety Precautions below. Installation and maintenance personnel should become familiar with any hazards present as well as any agency requirements before working with any equipment.

6.1 General Safety Guidelines

The user should follow safety guidelines provided by the Occupational Safety and Health Administration (OSHA) for additional protection. Information may be obtained from the following sources:

- National Electric Code (NEC)
- National Fire Protection Association (NFPA)
- Instrument Society of America (ISA)
- Factory Mutual Research Corporation (FM)
- Underwriters' Laboratories Incorporated (UL)
- Canadian Standards Association (CSA)

When in doubt about the safety of an area, the user should check with the local safety authorities. Always observe warning signs posted in the area and all labels on equipment.

6.2 Installation Safety Guidelines

- Never attempt to make voltage measurements within the Tank Gate Interface in the field.
- Maintenance should be performed only by authorized personnel.
- Always turn off the power before removing the case cover.
- Before installing/repairing any wiring to the Tank Gate Interface, make sure that the power is turned off at the main circuit breaker or switch. The power switch should be locked in the OFF position and labeled to prevent other personnel from turning the power on during installation.
- Before turning on power when installation is complete, make sure the cover of the Tank Gate Interface case is in place and tightly closed. NEVER REMOVE ANY COVERS WITHOUT FIRST TURNING OFF THE POWER.
- To prevent shock hazards, the housing of all units should be properly grounded in accordance with the National Electric Code. A grounding conductor should be wired to the grounding terminal provided on the Tank Gate Interface.
- In some applications, a substantial amount of heat is produced by other equipment inside or outside the enclosure. To assist in air circulation, place blower fans inside the enclosure.
- To prevent excessive heat, several steps can be taken. For most applications, normal convection cooling will keep the device components in the enclosure within the operating range. Proper spacing of components within the enclosure is usually sufficient for heat dissipation.
- Caution should be exercised when entering any area that is posted or otherwise assumed to contain hazardous gases. Always follow the guidelines provided by the Occupational Safety and Health Administration for your own protection.

Caution! Do not bring in unfiltered outside air. It may introduce harmful contaminants that could damage the Tank Gate Interface and components.

Caution! Never perform maintenance with power applied.

6.3 Installation

Standard systems are shipped with the motherboard and tank gauge interface module installed. The Tank Gate Interface installation procedure includes the installation of these individual components. Tank Gate Interface installation includes the following steps:

1. Mounting the Tank Gate Interface (section 6.3.1 on page 62)
2. Selecting the Unit Address (section 6.3.2 on page 62)
3. Wiring up Power (section 6.3.3 on page 62)
4. Grounding the Tank Gate Interface (section 6.3.4 on page 64)
5. Installing Communications (section 6.3.5 on page 64)

6.3.1 Mounting the Tank Gate Interface

Before mounting the Tank Gate Interface, make certain that any enclosure used can house the Tank Gate Interface. Refer to the dimensional drawing below (all dimensions are in inches). The recommended standard housing for the Tank Gate Interface is a NEMA TYPE 4 enclosure. This enclosure is suitable for both indoor and outdoor applications.

6.3.2 Select the Unit Address

Switch SW1 sets the Tank Gate Interface's one byte, binary address (0–15). Switch SW1–1 is the most significant bit (MSB) while switch SW1–4 is the least significant bit (LSB). When a switch is in the ON or CLOSED position, the resulting bit is a one.

Figure 6-1: Switch SW-1 setting for ID 1

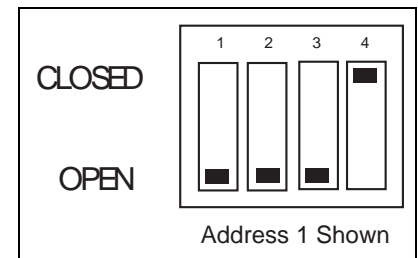

6.3.3 Wiring Up Power

The Tank Gate Interface operates from AC power.

Wiring 120 or 220 VAC Power

The Tank Gate Interface is powered by an isolation transformer with a 5 volt regulator.

- Remove cover if it is in place
- Connect the two power leads to terminals L and N of connector J2.
- Ensure that a ground connection is connected to the G terminal ground of connector J2. (see below)
- Install cover.

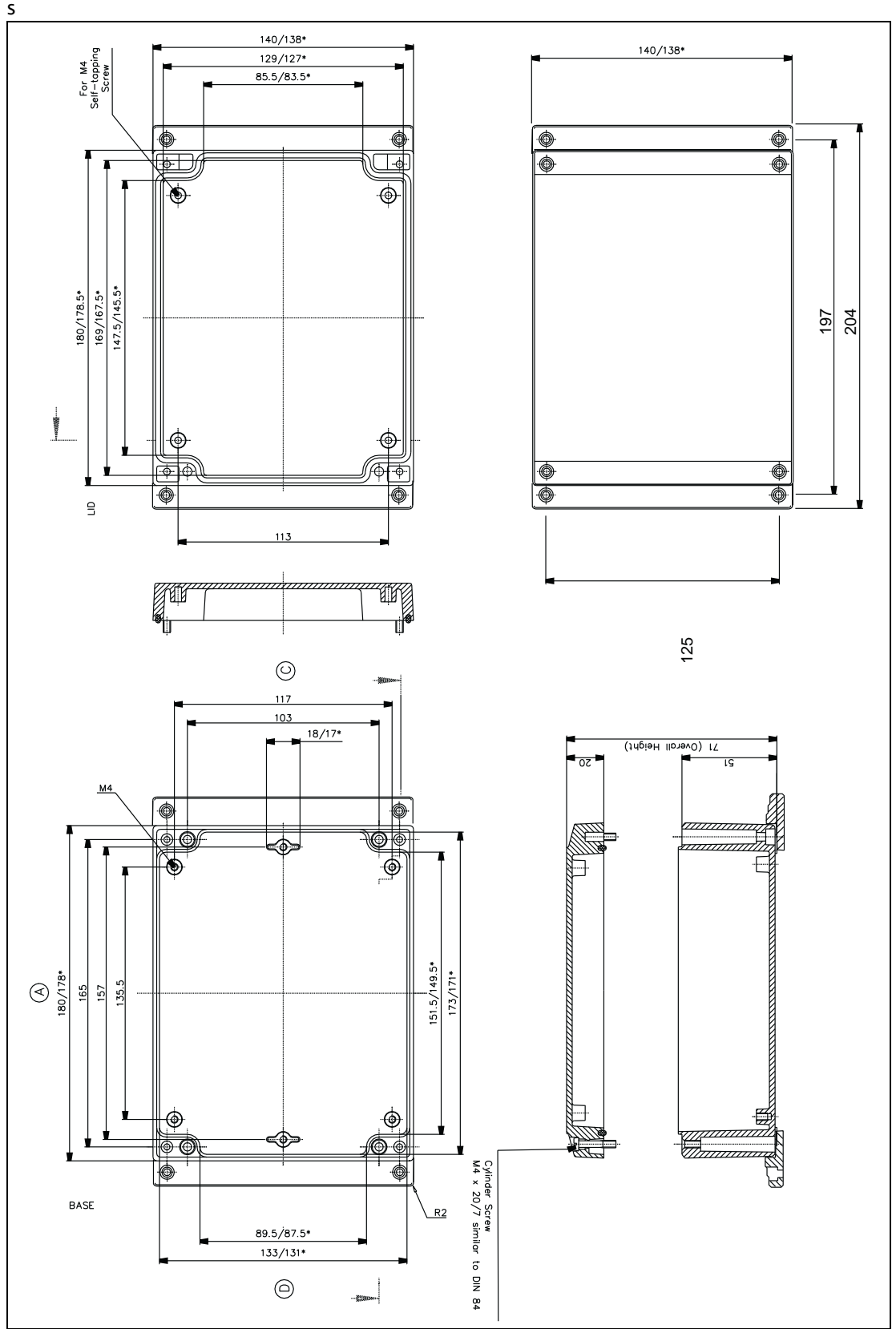

Figure 6-2: Tank Gate Interface Dimensions

6.3.4 Grounding

To allow use in harsh industrial environments, the Tank Gate Interface incorporates ANSI/IEEE surge protection. In solid-state control systems, grounding helps limit the effects of noise due to electromagnetic interference (EMI) and provides additional surge protection when high voltage switching circuits are connected to the unit. The grounding path for the Tank Gate Interface and its enclosure is provided by the equipment grounding connector. The resistance from the Tank Gate Interface ground to the grounding electrode must not exceed 1 ohm. Additional ground wires should be connected as required for each I/O module.

Caution! All applicable codes and ordinances must be observed when wiring the Tank Gate Interface.

6.3.5 Installing Communications

6.3.5.1 RS-232 Communications

- To install the RS-232 communication option, connect an RS-232 cable to connector J7 (COM0).

Note The 8311 TGI only supports communication on COM0.

6.3.5.2 Power-Up

Before the field cables are attached, perform an initial system verification.

6.3.5.3 Initial system verification

- Connect the power cable to power connector P1, then connect an RS-232 cable from a PC with ViewRTU to J7 (COM0).
- Power up the unit.

The CPU LED on the tank gauge interface module should toggle on and off. If the CPU indicator is not flashing, turn off system power and proceed with the Troubleshooting and Calibration chapter.

6.3.5.4 Establishing Host Communications

When the main system power is turned on, the Host communications status is set to On-line by default. The Tank Gate Interface then waits for a valid poll from the Host computer. If the communication cable is installed and the Host is running, a communications link is established. Verify this condition with a hand-held terminal or ViewRTU.

6.3.5.5 Verifying Host Communications

- Display the COM Point and verify that an On-line condition is indicated.

7 Using ViewRTU

7.1 Overview

This chapter describes the software used to configure the Tank Gate Interface. This chapter describes each of the menus found in the menu bar. Additionally, the chapter describes the system requirements and the installation procedure. Use this chapter in accordance with the Tank Gate Interface Software Blocks section.

ViewRTU software, a Microsoft Windows application, is designed to configure and view data points in the Tank Gate Interface. ViewRTU is a utility program that can be used for configuration, diagnostics, data acquisition and control. Since ViewRTU follows the Windows standard, the user that is familiar with Windows will be able to learn the program quickly. ViewRTU supports the Windows standard of selecting commands from a series of pull-down menus. If the user is not familiar with Windows-based programs, then refer to the Microsoft Windows manual for basic instruction.

7.2 System Requirements

The minimum requirements needed to run the ViewRTU application are listed below:

- 386/486/Pentium Personal Computer
- Microsoft Windows NT, 2000, or XP
- 96 MB RAM
- 2 MB free disk space
- 1 Com Port

7.3 Installing ViewRTU

To install the ViewRTU application, follow the steps listed below.

Installing ViewRTU

- Insert the CD into the CDROM or DVDROM drive.
- Select the drive that contains the disk from the Windows File Manager.
- Double click on the SETUP.EXE file. The setup program prompts the user for the drive and directory used to install the software.
- Select the drive and type in the directory name. Once the drive and directory are selected, the setup program copies all of the files to the chosen destination.
- When all of the files have been copied to the destination, the setup program automatically builds a program group with corresponding program items in the Windows Program Manager.

7.4 Executing ViewRTU



This section describes how to start up the ViewRTU program. The components of the window are also described in this section. To execute the ViewRTU program, follow the steps below:

Execute the ViewRTU program,

1. Select the ViewRTU program group from the Windows Program Manager.
2. Double-click on the icon to execute the ViewRTU application.

If more than one Tank Gate Interface definition file (DVR) exists, the following dialog box is displayed.

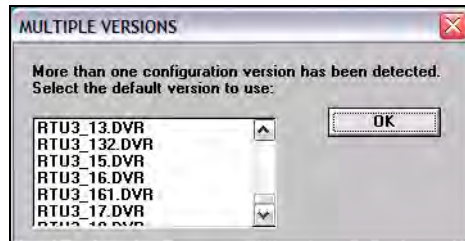

Figure 7-1: ViewRTU Version Selection dialog

Each version file contains setup information that matches the firmware in the Tank Gate Interface. This information allows a single version of ViewRTU to configure multiple versions of the Tank Gate Interface. For example, MSTG1_00.DVR is a definition file that is compatible with Tank Gate Interface firmware version 1.00. Select the version that matches the version of firmware in the Tank Gate Interface. Note that you can determine the firmware version by viewing the SysVer parameter of the SYS point.

3. Choose the desired version and select OK.

If only one Tank Gate Interface definition file (DVR) exists, the main window appears instead. The main window is seen below.

When the ViewRTU program is opened, a new file appears in the window. The components of this window are explained below.

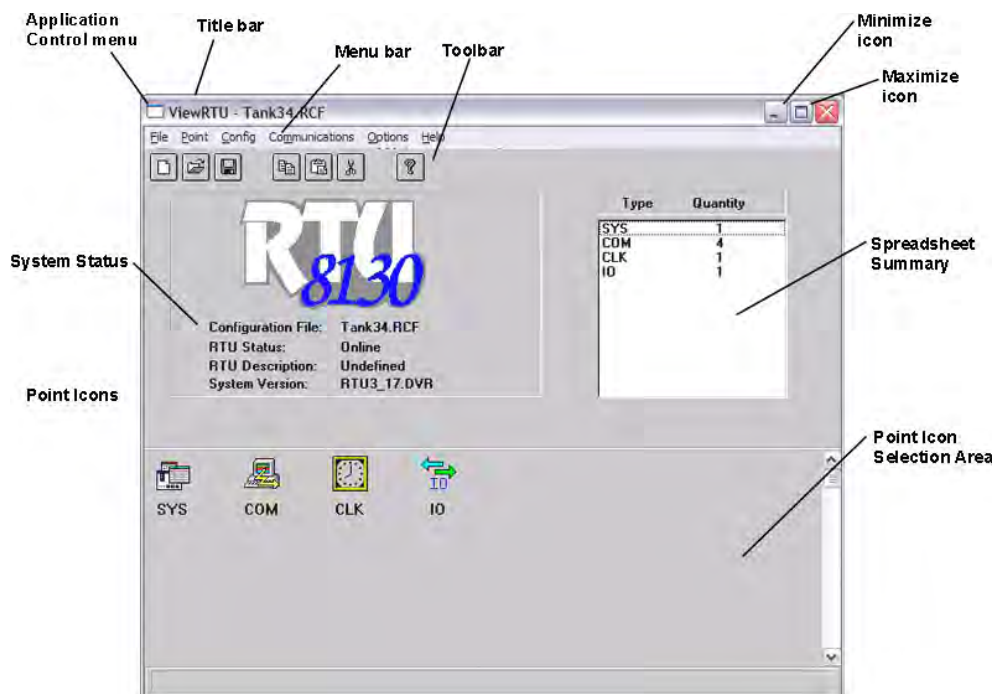

Figure 7-2: Main ViewRTU window with descriptions

7.4.1 ViewRTU window

This main window allows the user to perform the commands necessary to configure the Tank Gate Interface. The ViewRTU window contains the standard Windows components such as the Application Control menu, minimize/maximize icon buttons, title bar and menu bar.

The System Status area

Displays the system version as well as general information about the configuration file. The Tank Gate Interface file name is found in both the System Status area and the title bar.

The Tabular

Contains several push-button icons used to execute frequently used commands found in the menu bar. In the menu description below, each appears next to its associated menu option.

The Spreadsheet summary

Lists all the point types and corresponding number defined in the file. The Spreadsheet Mode can be used as a quick method for creating and editing the contents of each point by double-clicking on the desired point type. The parameters listed in the Spreadsheet summary directly correlate with each defined point.

Point Icon Selection Area

All the point icons are displayed in the Point Icon Selection Area. Point icons are visual representations of various software functions. When a new file is opened, several default point icons are displayed in the Point Icon Selection Area. These points are described in the Tank Gate Interface Software Blocks chapter.

7.5 The ViewRTU Menu Bar

This section describes all the menus found in the ViewRTU menu bar. The push-button icons found in the Toolbar are shown next to each associated menu option. This section primarily describes the functionality of each menu option. ViewRTU applications are presented in the Application section at the end of the chapter.

7.5.1 The File Menu

The File menu allows the user to create, open, and save configuration files. This menu also allows the user to save the current configuration to a different file name



Figure 7-3: The File menu

New

The user is able to create a new configuration file by clicking on the New push-button from the tool bar or by selecting New from the File menu. When selected, a dialog box appears displaying a list of configuration definition files. The user selects the desired file from this list.

Open

The user is able to select an existing configuration file by clicking on the Open push-button from the tool bar, or by selecting Open from the File menu. When selected, a dialog box appears displaying a list of configuration files. All configuration files are identified by the RCF extension. Once a file is selected, the point configuration data of the selected file is displayed. If the directory is empty, the user has the option of creating a new file by typing in the file name.

Save

The user is able to save the opened configuration file by clicking on the Save push-button from the tool bar or by selecting Save from the File menu. The user can save the file anytime the configuration has changed. If the file exists in the directory, the configuration is stored to the disk using the current file name. If the file has not been saved before or the name does not exist in the directory, the user is prompted to enter a configuration file name.

Save As

The Save As option is used to save the currently opened file under a different name. When selected, a dialog box appears prompting the user to enter a file name. If the selected file name already exists, the user has the option of overwriting the file. Otherwise, the user can create a separate file containing all the current configuration data of the present file. If the user chooses to create a separate file, the current file is automatically closed. Only one file may be open at a time.

Exit

The Exit option is used to close the ViewRTU application. If the current configuration file has not been saved, the user is prompted to save the file or cancel the option.

7.5.2 The Point Menu

Figure 7-4: The Point Menu

Add

The user is able to add a point to the current configuration. The user is able to add a point by clicking on the Add Point push-button from the tool bar or by selecting Add from the Point menu. The Select Point to Add dialog box appears:

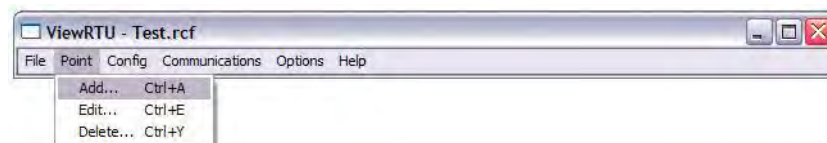
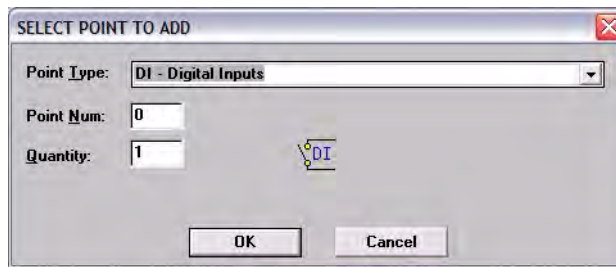

Figure 7-5: Dialog viewed when adding a new point

Select Point to Add dialog box

This dialog box displays a list of available point types, the point number, quantity and the corresponding point icon. The point icon is then added to the Point Icon Selection Area if it does not already exist. The Point Type lists the currently selected point. The user can select the desired point by selecting the point from the scroll list.

The Point Number defaults to “0” if the point type has just been defined. The maximum number of points entered depends on the selected point type. Once entered, the point quantity is displayed in the Summary Spreadsheet.

Multiple points of the selected type may be created simultaneously by entering the number in the Quantity edit box.

Edit



This option is used to modify the contents of a selected point. The user is able to edit an existing point by clicking on the Edit push-button from the toolbar or by selecting Edit Point from the Point menu. The Select Point to Edit dialog box appears:

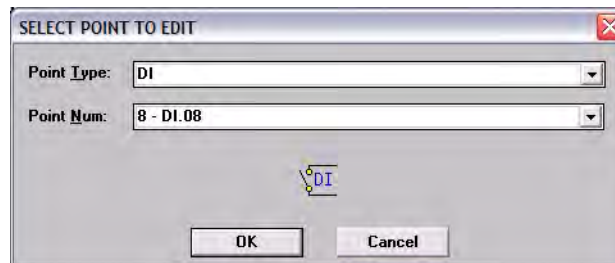

Figure 7-6: Edit Point selection dialog

Edit Point selection dialog

This dialog box displays a list of defined point types and corresponding point numbers. The point icon is also displayed for identification as well as the tag, if a tag has been assigned.

Once a point is selected, the Edit Point dialog box appears:

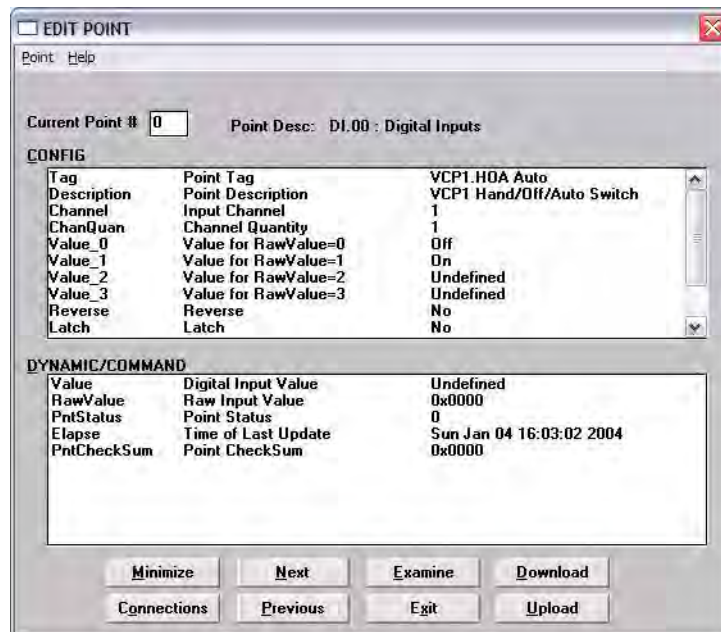

Figure 7-7: Edit Point dialog

Edit Point dialog

This dialog box contains all dynamic and configurable field information. The user is able to edit point data. Exiting this dialog box returns the user to the main window.

Note Several other methods can be used to display the Edit Point dialog box. These methods and other information are explained in greater detail in the Application section.

Delete



This option lets the user delete one point at a time. The user is able to delete an existing point by clicking on the delete push-button from the toolbar or by selecting Delete Point from the Point menu. The Select Point to Delete dialog appears:

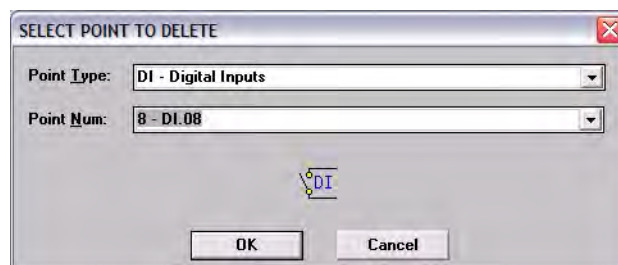

Figure 7-8: Point deletion dialog

Point deletion dialog

This dialog box displays a list of defined point types and corresponding point numbers. The point icon is also displayed for identification as well as the tag, if a tag has been assigned.

The user selects the point type and the corresponding number to be deleted.

7.5.3 The Config Menu

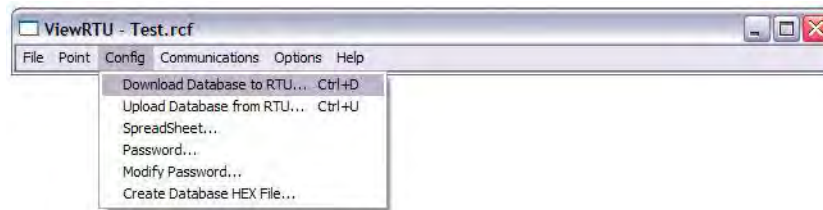

Figure 7-9: The Configuration Menu

Download Database to RTU

The Download Database to RTU option is used to download configuration data to the Tank Gate Interface. The following dialog box appears:

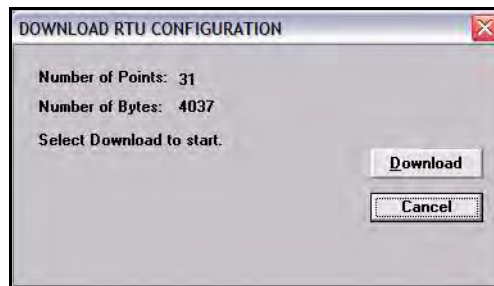

Figure 7-10: Dialog used to download Tank Gate Interface data

Click the Download push-button to download data to the Tank Gate Interface

Upload Database from Tank Gate Interface

The Upload option is used to upload configuration data from the Tank Gate Interface. The following dialog box appears:

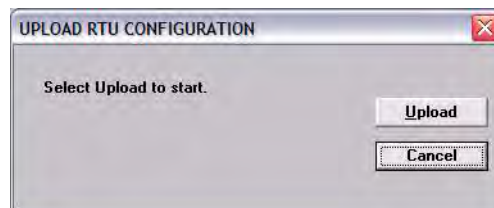

Figure 7-11: Dialog used to upload Tank Gate Interface data

Click the Upload push-button to download data from the Tank Gate Interface. Once the upload is complete, the main window changes to display the uploaded configuration.

Spreadsheet

The Spreadsheet option is used to configure, download, and upload point data points in spreadsheet mode.

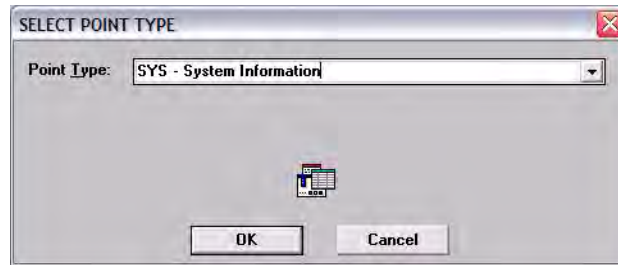

Figure 7-12: Spreadsheet Mode Edit window

Password

The user can use the Password option to gain access to a protected file.

Once a password has been assigned, the user must enter the password when attempting to edit the Tank Gate Interface configuration file. This password is only entered once in the duration of the ViewRTU program.

To enter the password

- Select Config and click on Password.
- Click on the edit box in the Password dialog. Type in the password.
- Click on OK.



Figure 7-13: Configuration Password dialog

Modify Password

The user can use the Modify Password function to protect all Tank Gauge Configuration files by issuing and changing a password.

Creating a Password

- Select Config and click on Password. The Change Password dialog appears.
- In the New Password edit box, enter the password. If no password currently exists, leave the Old Password field blank.
- In the Retype New Password edit box, confirm the entry by reentering the password.
- Click on OK.



Figure 7-14: Change Password dialog

Note Make sure that you write down the password and store it in a secure place.

Changing the Password

- Select Config and click on Modify Change Password. The Change Password dialog appears, as illustrated in 'creating a password'.
- In the Old Password edit box, enter the current password.
- In the New Password edit box, enter the new password.
- In the Retype New Password edit box, confirm the entry by reentering the new password.
- Click on OK.

Note Make sure that you write down the password and store it in a secure place.

7.5.4 The Communications Menu

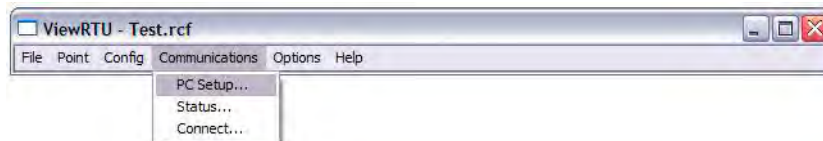

Figure 7-15: The Communications Menu

PC Setup

The PC Setup option allows the user to define the communications channel and data rate characteristics of the communications port. When selected, the following dialog box appears. This example dialog box contains the default settings for communications setup.

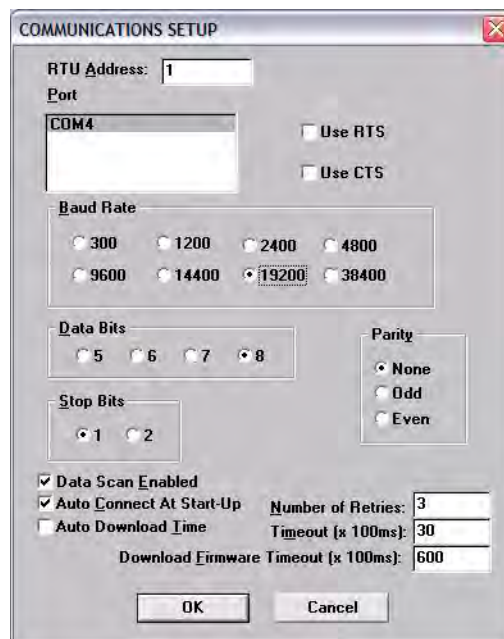

Figure 7-16: Port Communications Setup dialog

Port Communications Setup dialog

This dialog box allows the user to enter the specifications of the Tank Gate Interface's communication port. When OK is selected, the setup data is stored as the default setup next time ViewRTU is executed.

Status

The Status option is provided so the user is able to observe communications data. The following dialog box appears when this option is selected.

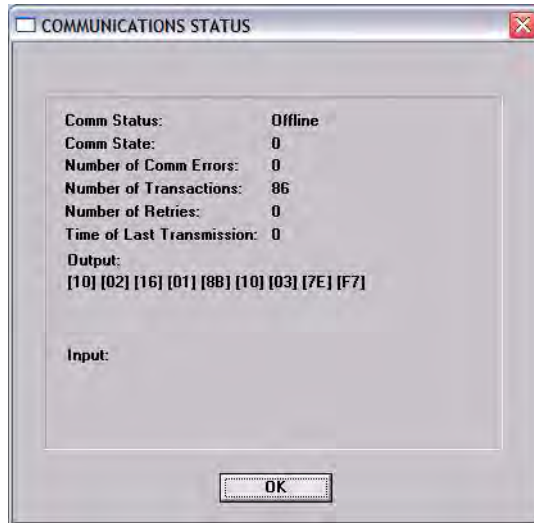

Figure 7-17: Communications Diagnostics dialog

Connect

The Connect option is used when the user needs to search for a specific Tank Gate Interface. The following dialog box appears when the option is selected.

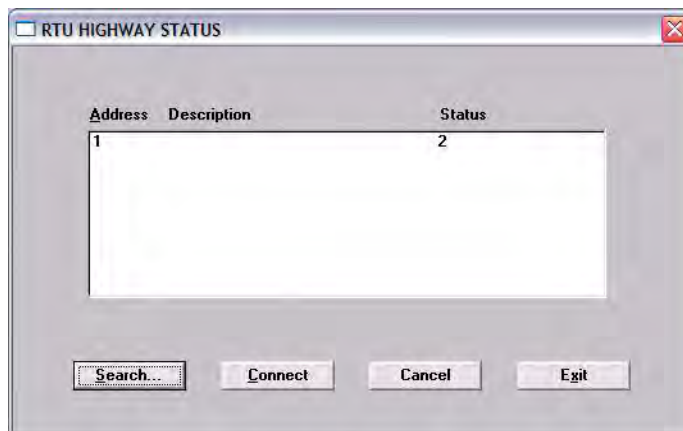

Figure 7-18: Tank Gate Interface search dialog

Tank Gate Interface search dialog

This dialog box lists the address, description and current status of each Tank Gate Interface. From this dialog box the user can select an Tank Gate Interface and establish communications with the selected Tank Gate Interface.

7.5.5 The Options Menu

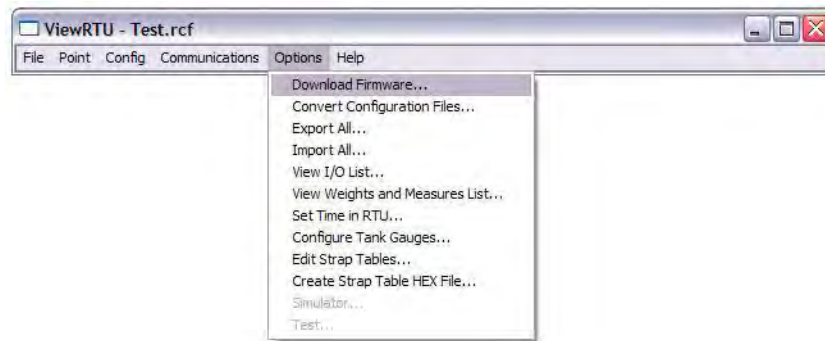

Figure 7-19: The Options Menu

Convert Configuration Files

The Convert Configuration Files option is used once the Download Firmware option has been executed. This option converts configuration files from one version to another. When selected, the following dialog box appears.

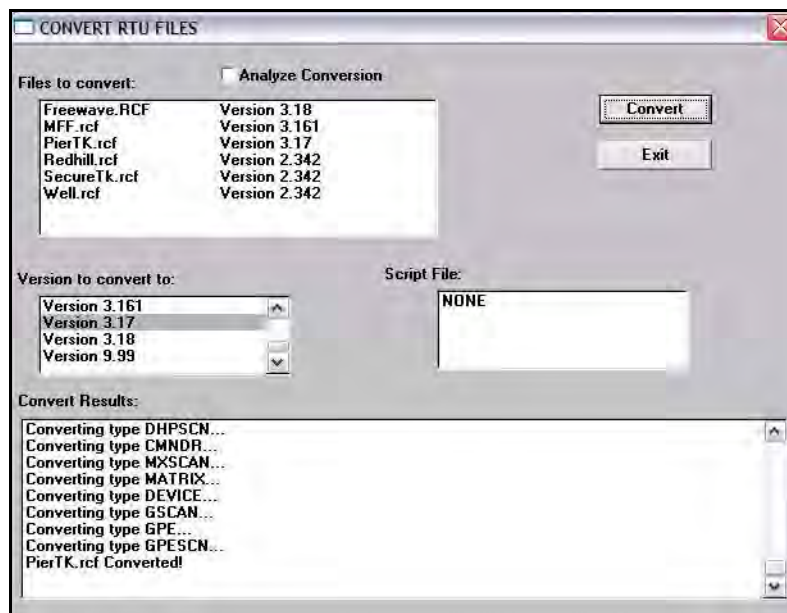

Figure 7-20: Convert ViewRTU versions dialog

Convert ViewRTU versions dialog

This dialog box allows the user to convert a file. The user has the option of first analyzing the effects of converting the file. A script file can also be selected to alter the behavior of the conversion. Script files are provided on the upgrade disk.

Export All

The Export All option allows the user to export all of the database in the Tank Gate Interface. Each point type is exported to a file in the CSV file format. For example, the Analog Input points are all exported to the file 'AI.CSV'. This means that the user can not specify each file name as the data is exported. The user does have the ability to specify the directory to export the data to. The user must create and then select the subdirectory for the export operation. We suggest

that you organize the directories with names corresponding to the Tank Gate Interface address. If you have two Tank Gate Interface's, use the Windows File Manager program to create subdirectories \VIEWRTU\RTU1 and \VIEWRTU\RTU2. All of the files for Tank Gate Interface #1 should be written to \VIEWRTU\RTU1; Tank Gate Interface #2's data would go to \VIEWRTU\RTU2 and so on.

The exported data can be edited using a spreadsheet program such as Microsoft Excel, or a database program like Microsoft Access. Many programs can read and write data in the CSV file format. You can make backups of your RCF file by exporting the data in the CSV file format.

The exported data can be read back with the Import All option. The Spreadsheet Mode also has an option to import CSV file data.

Import All

The Import All option allows the user to import the entire Tank Gate Interface database. Each point type must have been exported previously in order to import data. This can be accomplished using the Export All option, or by point type using the Spreadsheet Mode. The data is read from files in the CSV file format. For example, all of the Analog Input points are imported from the file 'AI.CSV'. The user must select the subdirectory to import the data from.

The CSV file data can also be imported using the Spreadsheet mode.

View I/O List

The View I/O List option allows the user to create a list of the I/O points connected to the Tank Gate Interface. The list is limited by listing points that have the Chan or Module parameters. These parameters are always used in cases where I/O is involved. The list is created by writing to the file 'POINTLST.TXT' and launching the Notepad program. The user can print this file using Notepad, or exit and return to ViewRTU.

Set Time in RTU

The Set Time in RTU option sets the time in the CLK point to the same time as the PC running ViewRTU.

7.5.6 The Help Menu

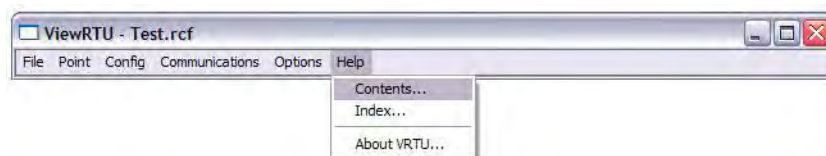

Figure 7-21: The Help Menu

Contents

The Contents option opens the table of contents of the ViewRTU on-line help.

Index

The Index option opens the index for the ViewRTU on-line system. This index lists all the help screens contained in the help system.

About VRTU

The About RTU... option displays a dialog box describing the copyright information and the application version number.

7.6 Using ViewRTU

By using ViewRTU, the user is able to define or modify sub-programs called Software Blocks. Software blocks are used to configure the Tank Gate Interface.

Note Refer to the Tank Gate Interface Software Blocks chapter for specific examples. The chapter provides a description of the parameters for each point as well as examples of the connections to other points.

Tank Gate Interface software blocks are functions that the user can configure to perform various tasks. Software Blocks are available to scan data from a slave device, control a pump, serve data to other Host systems or perform calculations. Each function type contains both the code and data necessary to perform the function. Software Blocks are identified by their type (example: AI, DI, LJ2000 and PUMP). Points are individual instances of software blocks. Each point must be added and then configured. Adding a point makes the point available for configuration. All defined points appear in both the Point Icon Selection area and the Spreadsheet Summary in the main window.

Configuring the point involves entering configuration parameters. In some cases, connections to other points are required in order to perform a task. Creating connections involves setting references to allow data to be transferred between points.

7.6.1 Overview

An outline of the section is listed below:

Configuring Single Points

This section describes the method used to configure individual points including:

- Adding a Point
- This section describes how to define a point from the Main window.
- Entering Point Data
- This section describes how to enter the point's parameters. Parameters are entered from the Edit Point Window.
- Modifying Strap Tables
- This section describes how to modify strap tables in ViewRTU.

Configuring Multiple Points

This section describes the spreadsheet mode. The principles involved in point configuration are the same, but the methods are slightly different.

- Adding Multiple Points
- This section describes how to define a point from either the Main window or the Spreadsheet Mode window.
- Entering Point Data
- This section describes how to enter a point's parameters. Parameters are entered from the Spreadsheet Mode window.

Creating and Editing Connections

This section describes how to create connections between various points. Points may be used to retrieve and/or deliver data from other points.

7.6.2 Configuring Single Points

Configuring the point involves entering configuration parameters. In some cases, connections between points must also be required in order to perform a function. All of these steps can be implemented from the Point Connections window. To display the Point Connections window, follow one of the methods listed below:

Adding a Point



The user is able to add a point or point type by clicking on the Add Point push-button from the toolbar or by selecting Add from the Point menu. Once the point is added, the user is then able to configure the point. Defined point types appear in the Point Icon Selection Area and in the Spreadsheet Summary of the main window.

Entering Point Data

This section describes how to configure the parameters of any point. Each point has its own Edit Point window that requires some degree of configuration. Both the configuration and dynamic attributes of the point are found in the Edit Point Window. From this window, the user is able to view and edit database parameters.

Several methods can be used to display this window depending on the user's current location in the program:

- If in the Main window, select Edit from the Point menu. Select the desired point type and corresponding point number.
- If in the main window, double-right click on the point icon.
- If in the Point Connections window, double-left click on the focus point icon.
- If in the Point Connections window, double-right click on a point icon other than the focus point icon.

The following example window appears.

CONFIG		
Tag	Point Tag	VCP1.HOA Auto
Description	Point Description	VCP1 Hand/Off/Auto Switch
Channel	Input Channel	1
ChanQuan	Channel Quantity	1
Value_0	Value for RawValue=0	Off
Value_1	Value for RawValue=1	On
Value_2	Value for RawValue=2	Undefined
Value_3	Value for RawValue=3	Undefined
Reverse	Reverse	No
Latch	Latch	No

DYNAMIC/COMMAND		
Value	Digital Input Value	Undefined
RawValue	Raw Input Value	0x0000
PntStatus	Point Status	0
Elapse	Time of Last Update	Sun Jan 04 16:03:02 2004
PntChecksum	Point CheckSum	0x0000

Figure 7-22: Edit (Digital) Point dialog

Edit (Digital) Point dialog

This window is used to view and modify the Dynamic and Configuration parameters of the selected point. The Edit Point window is identified by the Point Description and associated current Point Number listed at the top of the window.

This window contains two list boxes and a series of push-buttons. The top list box contains the configuration parameters of the point, while the bottom list box contains Dynamic and Command parameters.

The first column contains the name of the parameter and the second column contains descriptions of the parameters. The third column of the Configuration parameters section contains the default data. The user can change a value by double-clicking an entry and entering the new variable. If a Tank Gate Interface is connected and on-line, the third column of the Dynamic parameters will update in real-time.

Edit Point Window Push-buttons

The user is able to perform a series of functions from selecting the push-buttons found in the bottom of the Edit Point window. Each push-button is described below.

Minimize

The Minimize push-button creates a “mini window” of selected parameters. This push-button enables the user to observe relationships between dynamic parameters and how the changes affect the point.

Clicking the Minimize shrinks the window so that only one or more selected list box parameters are displayed. The user may have multiple minimize windows opened simultaneously. This capability is useful for testing and debugging.

Minimizing the Edit Point Window

- Highlight by single-clicking the left mouse button on one or more parameters.
- Click on the Minimize push-button. A following example window appears:



Figure 7-23: Edit Point dialog minimized

Note Parameters can be edited in the minimized mode by double-clicking the right mouse button on the desired selection.



- To maximize the window, click on the maximize icon or click on the Application Control menu of the window and select the Maximize menu option.

Connections

The Connections push-button allows the user to switch back to the Point Connections dialog box.

Next

The Next push-button allows the user to step through the list of points. The user is able to view the Edit Point window of the following point number. Selecting Next at the end of the point number list wraps to the beginning.

Previous

The Previous push-button allows the user to step through multiple points of a point type. The user is able to view the data in the Edit Point window of the previous point. Selecting Previous at the first point number wraps to the last point number of the list.

Examine

The Examine push-button is used to go to the Point Connections window of the reference point in the list box.

Opening a point connection window

- Highlight the desired reference data parameter from the Edit Point window.
- Click on the Examine push-button.

The user is taken to that reference point's Point Connections window.

Exit

The Exit push-button exits the current point configuration and returns the user to the main menu.

Download

The Download push-button allows the user to download the entire point data to the Tank Gate Interface.

Upload

The Upload push-button allows the user to upload the entire point data from the Tank Gate Interface.

7.6.3 To modify a Value

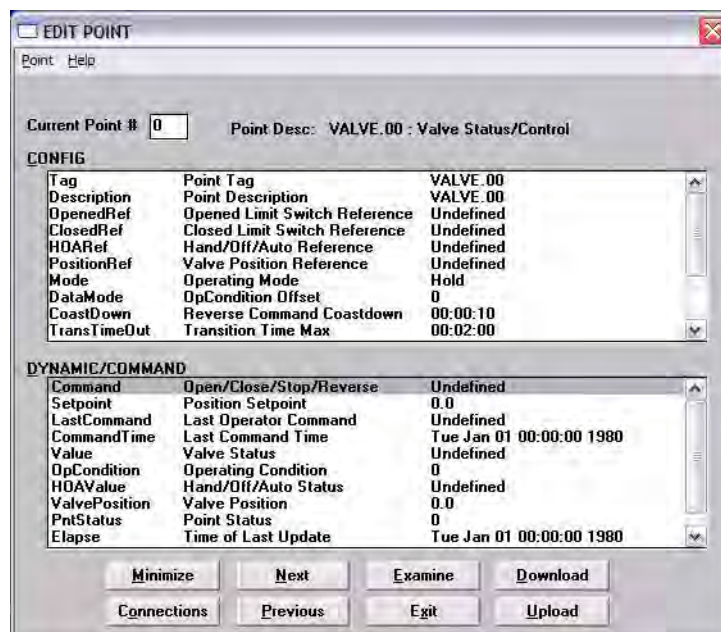

Figure 7-24: Edit Point dialog (adding a value)

To modify a value

- Double-click the desired parameter to enter a new value. The following example Modify Point dialog box appears.

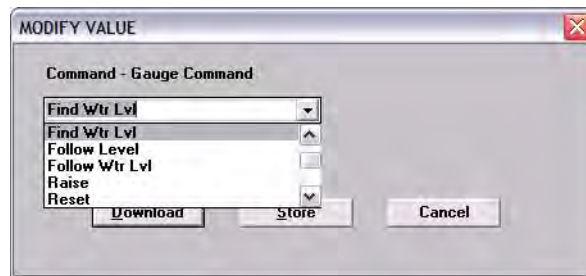

Figure 7-25: Edit point parameter value dialog

Edit point parameter value dialog

From this dialog box, the user is able to enter a value for the selected parameter. The dialog box varies according to the selected parameter. In some dialog boxes the user is able to enter the name or data directly in the edit box. Other dialogs contain a scroll list from which the user selects a value. The new value can then be downloaded to the Tank Gate Interface or stored locally if the Tank Gate Interface is off-line.

To modify a Reference

There are two ways to modify a reference. One method is performed from the Edit Point window, and the other method is performed from the Point Connections window. For convenience, both methods are listed below:

To modify a Reference

- In the Edit Point Window Double-click the desired reference parameter to enter a new value. The following dialog box appears.
- In the Point Connections Window drag and drop the point icon onto the PntRef. The following dialog box appears.

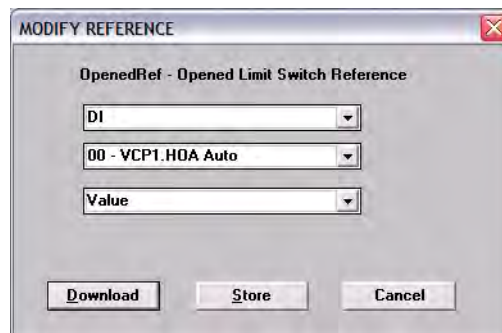

Figure 7-26: Edit point parameter reference dialog

Edit point parameter reference dialog

This dialog box is used to select a new point reference, corresponding point reference number, and/or parameter. If displayed from the Edit Point window, the selection lists the default value. If displayed from the Point Connections window, the most consistent value is selected as the default.

Only valid references appear in the list boxes contained in this dialog box. The new reference can then be downloaded to the Tank Gate Interface or stored locally if the Tank Gate Interface is off-line.

7.6.4 Configuring Multiple Points

The spreadsheet mode is one of the methods used to configure points. This method is the most beneficial when editing and viewing multiple points of the same type. Spreadsheets of each defined point are found in the Spreadsheet Summary section in the main window.

There are some differences between the regular and spreadsheet methods. First, the user is not able to view the Point Connections window in Spreadsheet Mode. This mode is used mainly for viewing and entering point data. Second, the spreadsheet focuses on points of a single type; it does not offer a “big picture” view of multiple point types.

Adding Multiple Points



The user is able to add a point by using the same method used to add single points. The user can click on the Add Point icon or push-button from the toolbar or by selecting Add from the Point menu in the Main window. Once the point is added, the user is then able to define the point. Defined points appear in the Point Icon Selection Area and in the Spreadsheet Summary of the Main window.

Note The user can add a point by selecting Add from the Point menu in the Spreadsheet Mode window. This menu is described later in the section.

Adding Multiple Points

- Double-click on the desired point type in the Spreadsheet Summary. The following example Spreadsheet Mode window appears.

SPREADSHEET MODE							
Point Edit Options							
D	U		Tag	Mode	LevelRef	TempRef	WaterRef
D	U	0	TANK.00		0 NMS53.00.Level	Al.00.Value	Al.01.Value
D	U	1	TANK.01		0 NMS53.01.Level	Al.02.Value	Al.09.Value
D	U	2	TANK.02		0 NMS53.02.Level	Al.03.Value	Al.10.Value
D	U	3	TANK.03		0 NMS53.03.Level	Al.04.Value	Al.11.Value
D	U	4	TANK.04		0 NMS53.04.Level	Al.05.Value	Al.12.Value
D	U	5	TANK.05		0 NMS53.05.Level	Al.06.Value	Al.13.Value
D	U	6	TANK.06		0 NMS53.06.Level	Al.07.Value	Al.14.Value
D	U	7	TANK.07		0 NMS53.07.Level	Al.08.Value	Al.15.Value

Figure 7-27: Spreadsheet Mode Window

Note Refer to the following Entering Point Data section for a description of the Spreadsheet Mode window.

Entering Point Data

This section explains the window used to configure multiple points of a single point type. When the user double-clicks on a point type, the following example dialog box appears:

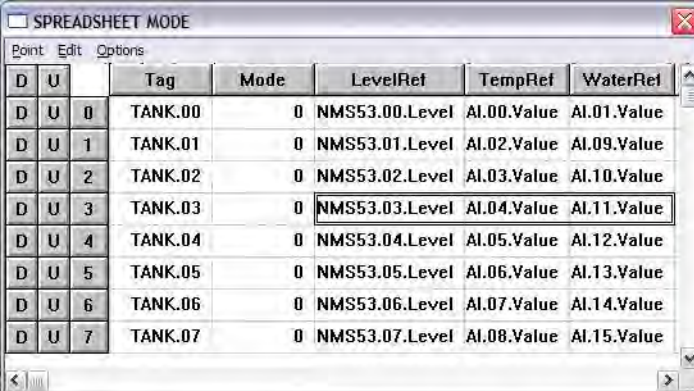

The screenshot shows a window titled "SPREADSHEET MODE" with a menu bar containing "Point", "Edit", and "Options". Below the menu bar is a table with the following data:

D	U		Tag	Mode	LevelRef	TempRef	WaterRef
D	U	0	TANK.00	0	NMS53.00.Level	AI.00.Value	AI.01.Value
D	U	1	TANK.01	0	NMS53.01.Level	AI.02.Value	AI.09.Value
D	U	2	TANK.02	0	NMS53.02.Level	AI.03.Value	AI.10.Value
D	U	3	TANK.03	0	NMS53.03.Level	AI.04.Value	AI.11.Value
D	U	4	TANK.04	0	NMS53.04.Level	AI.05.Value	AI.12.Value
D	U	5	TANK.05	0	NMS53.05.Level	AI.06.Value	AI.13.Value
D	U	6	TANK.06	0	NMS53.06.Level	AI.07.Value	AI.14.Value
D	U	7	TANK.07	0	NMS53.07.Level	AI.08.Value	AI.15.Value

Figure 7-28: Spreadsheet Mode: Entering point parameter data

Spreadsheet Mode

This window displays a list of all the point numbers of a selected point type. The user is able to add, configure, and edit points. The user is able to select and enter the parameters for each point or group of points. The user can also export/import files and control the selection of displayed parameters.

Compare this window to the Edit Point window (see Figure 7-7 on page 70). The two windows contain the same parameters. In the spreadsheet mode, the user is able to view and modify all the points of the selected type. In the Edit Point window, the user steps through a window for each point number using the Next and Previous push-buttons.

The left two columns, D and U are used to download and upload, respectively, the information found in the corresponding row(s). The third column lists the point numbers. The Spreadsheet Mode menu bar contains menus used to perform various functions to one or more points. Each of the Spreadsheet Mode menus is described below.

The Point Menu

This menu contains the same menu options found in the main window's menu bar. Refer to The Point Menu section for a description of the menu options.

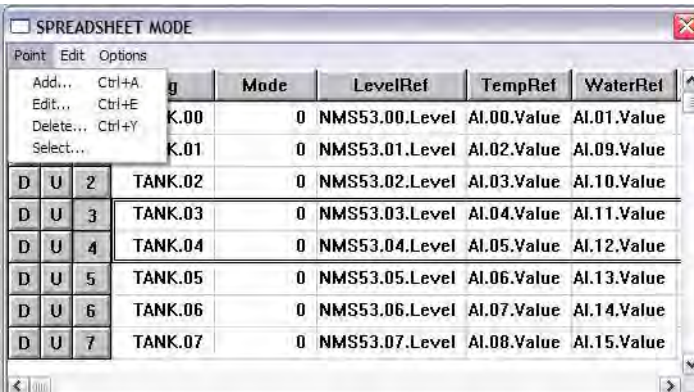

The screenshot shows the same "SPREADSHEET MODE" window as in Figure 7-28, but with the "Point" menu open. The menu options are:

- Add... Ctrl+A
- Edit... Ctrl+E
- Delete... Ctrl+Y
- Select...

The table data is the same as in Figure 7-28.

Figure 7-29: Spreadsheet Mode: The Point Menu

This option is useful for creating, deleting and editing points without having to exit out of the Spreadsheet mode.

The Edit Menu

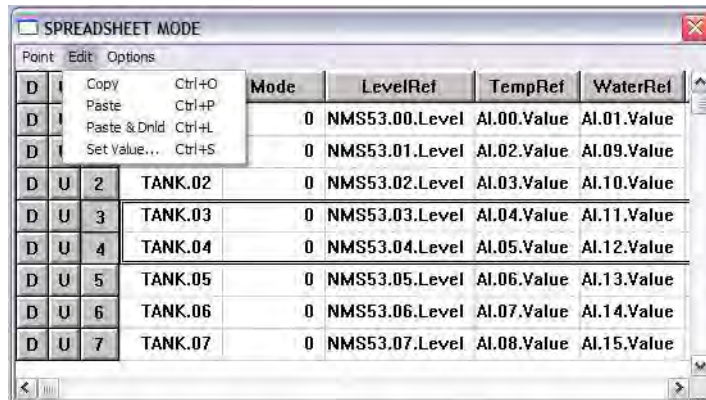

Figure 7-30: Spreadsheet Mode: The Edit Menu

Copy

The Copy option allows the user to copy data from a one or more selected cells.

1. Select one or more cells to copy. To select one or more rows, click on the number(s). To select one or more columns, click on the parameter(s).
2. Select the Copy option from the Edit menu. The selected cells outline changes from black to red.

Note To undo the Copy option, press the Esc key. Pressing the Esc key removes the selection outline from the selected cells.

Paste

The Paste option allows the user to paste the copied group of cells (red outline) to the currently selected group of cells (black outline).

1. Select the cells on which the copied cells will be pasted.
2. Select the Paste option from the Edit menu.

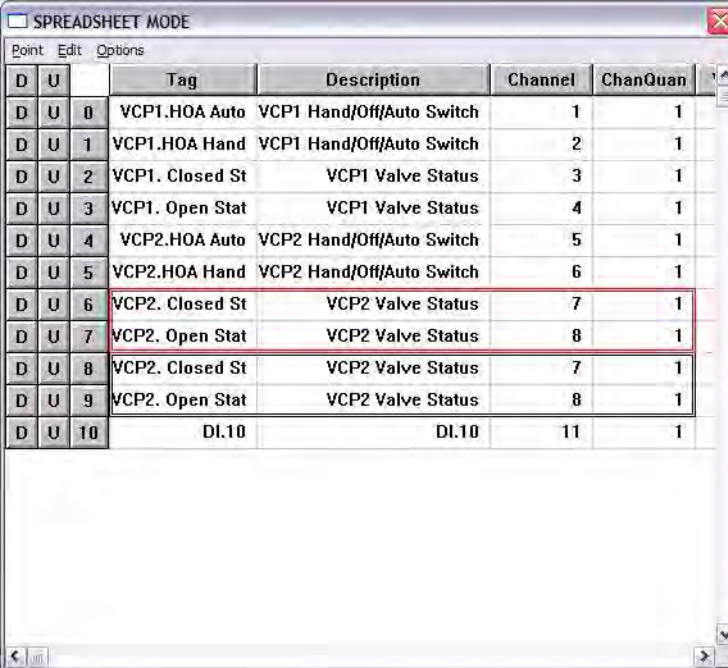

D	U	Tag	Description	Channel	ChanQuan	
D	U	0	VCP1.HOA Auto VCP1 Hand/Off/Auto Switch	1	1	
D	U	1	VCP1.HOA Hand VCP1 Hand/Off/Auto Switch	2	1	
D	U	2	VCP1. Closed St VCP1 Valve Status	3	1	
D	U	3	VCP1. Open Stat VCP1 Valve Status	4	1	
D	U	4	VCP2.HOA Auto VCP2 Hand/Off/Auto Switch	5	1	
D	U	5	VCP2.HOA Hand VCP2 Hand/Off/Auto Switch	6	1	
D	U	6	VCP2. Closed St VCP2 Valve Status	7	1	
D	U	7	VCP2. Open Stat VCP2 Valve Status	8	1	
D	U	8	VCP2. Closed St VCP2 Valve Status	7	1	
D	U	9	VCP2. Open Stat VCP2 Valve Status	8	1	
D	U	10	DI.10	DI.10	11	1

Figure 7-31: Spreadsheet Mode: Copying and Pasting point parameter data rows.

Note If the number of rows and columns in both selections do not match, the extra copied cells are truncated. Incompatible cells containing different data types are not copied; instead a warning is displayed.

Paste & Dnld

The Paste & Dnld option is very similar to the Paste menu selection. The only difference is that the Paste & Dnld selection downloads the updated data parameters.

Set Value

The Set Value option allows the user to enter or select a value for a parameter.

1. Click on the desired cell or column.
2. Select Set Value from the Edit menu. The Modify Value dialog box appears:

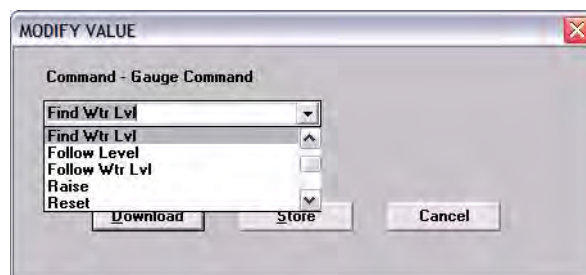

Figure 7-32: Spreadsheet Mode: Editing point parameter values

3. Enter or select a value from the scroll list.

Set Value (with Auto Increment)

This option can also be used for numeric parameters such as channels to auto increment the value. Follow the procedure below:

1. Click on each desired cell or column.
2. Select Set Value from the Edit menu. The following dialog box appears:

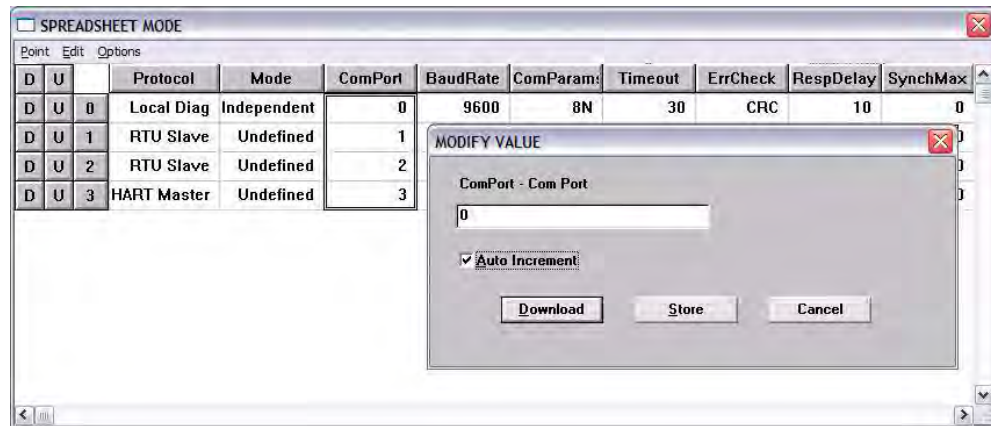

Figure 7-33: Spreadsheet Mode: Editing point parameter values using auto increment

Each value in the column is incremented by one for the range of rows selected. All cells that are selected and match the data type of the value are set to the value.

The Options Menu

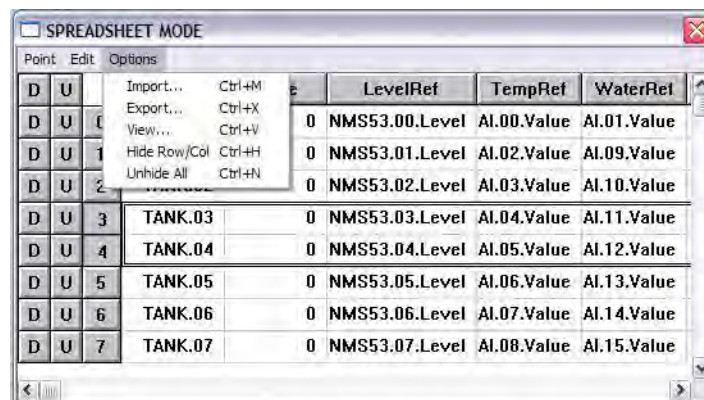

Figure 7-34: Spreadsheet Mode: The Options Menu

Import

The Import option allows the user to import a point or group of points that match the current point type. The imported file is named according to the point type with the 'CSV' file extension.

Export

The Export option allows the user to export a selected point or all the points that match the current point type to the default directory. The export file is saved in a file named according to the point type with the 'CSV' file extension.

Note The user is able to change the source directory in the INI file.

View

The View option allows the user to display selected parameter types. Selecting this option displays the following View Point Parameters dialog box.

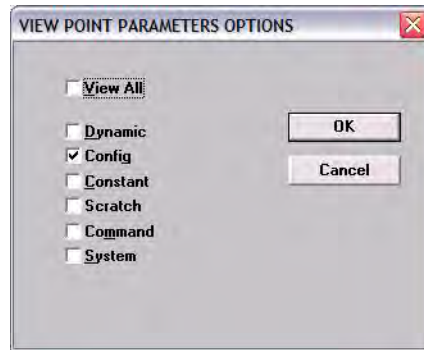

Figure 7-35: Spreadsheet Mode: Viewing selected parameter types dialog

The user is able to select any combination of parameter types. The user is able to select any combination of classifications. The classifications are described briefly below.

Parameter Type	Description
Dynamic	Real-time data such as status
Config	General specifications such as tag and description
Constant	Data that does not change and/or can not be changed
Scratch	Temporary data that is typically hidden from the user
Command	Output command data
System	System data (should not be changed by the user)

Note The default View setting is the Config parameter type.

Hide Row/Col

The Hide Row/Col option allows the user to hide selected rows or columns.

Note The Copy and Paste operations do not affect hidden rows and columns.

1. Select one or more rows or columns.
2. Select the Hide Row/Col option from the Options menu.

The selected rows or columns are indicated by a '+' in the row or column buttons heading. The following dialog box illustrates this feature.

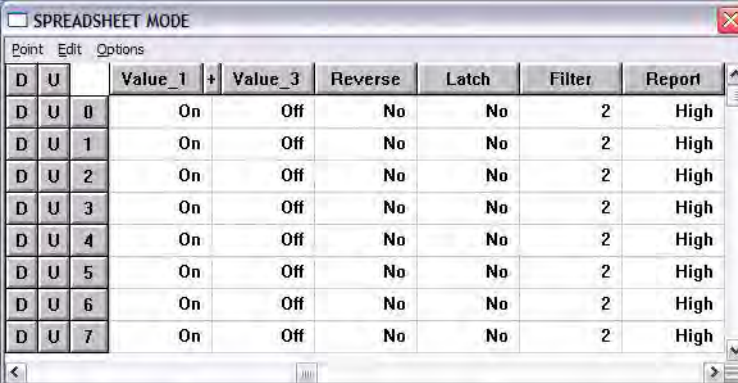

D	U	Value_1	Value_3	Reverse	Latch	Filter	Report
0		On	Off	No	No	2	High
1		On	Off	No	No	2	High
2		On	Off	No	No	2	High
3		On	Off	No	No	2	High
4		On	Off	No	No	2	High
5		On	Off	No	No	2	High
6		On	Off	No	No	2	High
7		On	Off	No	No	2	High

Figure 7-36: Spreadsheet Mode: Hiding columns

The user can unhide a row or column by clicking on the associated '+'. To unhide all the rows/columns, the user can select the Unhide All option from the Options menu.

Unhide All

The Unhide All option allows the user to reveal all of the rows or columns that are currently hidden.

7.6.5 Creating and Editing Connections

Several methods can be used to display this window depending on the user's current location in the program. These methods are listed below:

- If in the Main window, double-left click on the point icon.
- If in the Edit Point window, click on the Connections push-button.
- If in the Point Connections window, double-left click on a point icon other than the focus point to view the Point Connections window for the selected point.

Note If multiple points exist, a selection window is displayed showing all the available points.

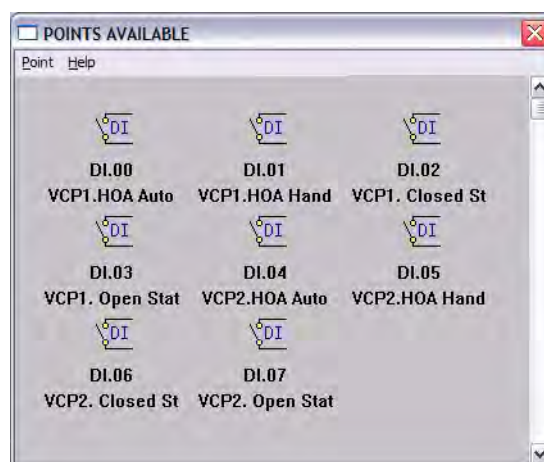

Figure 7-37: Edit Point selection window

Displaying the Point Connections window.

- Double-click on one of the icons to display the Point Connections window. The following example Point Connections window appears.

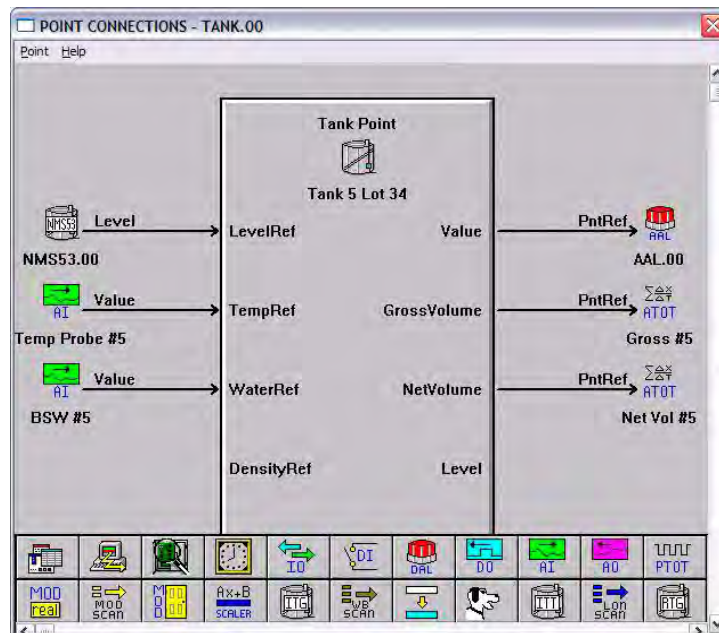

Figure 7-38: Point Connections Window

Point Connections Window

This graphic display visually illustrates the reference connections of the focus point. From this display, the user is able to select reference points, create connections between these points, and enter configuration parameters.

The point icons located in the Icon Bar utilize the drag-and-drop features of Windows. The user is able to connect the output data of one point to the input of another point.

The connections are made through point references and links. Not all points have references, but any parameter of a point can be referenced. Some references are incompatible with some types of data. The program can determine if a reference is valid, but it cannot determine if the reference is meaningful.

The Input Data parameters, which are located on the left side of the software block, are references. The Output Data parameters, which are located on the right side, are most commonly referenced by other points.

To create a Connection:

1. Select the desired point icon from the Icon Bar and drag it onto the desired data parameter.
 - If the point dropped does not exist, then the user needs to define the point as described in the previous section. The same configuration process is used to define the point.
 - If multiple points exist, the user is prompted to select the point number.
 - If the point dropped already contains a reference to another input reference, a dialog box will appear inquiring whether or not to overwrite the existing reference.
2. The point icon will appear to the right or left of the selected arrow as seen Figure 7-38.

Note Double-left clicking on a focus point icon allows the user to view the point's Edit Point window.

Note Double-left clicking on the input source or the output destination icon allows the user to step through each corresponding Point Connections window, if applicable.

Note Double-right clicking on the input source or the output destination icon allows the user to view the point's Edit Point window.

8 Troubleshooting

8.1 Overview

This chapter describes the procedures used to isolate hardware faults. Three push-buttons and eight status Led provide verification of Tank Gate Interface proper operation. If the Tank Gate Interface is not functioning normally, the user is able to troubleshoot the device by performing one or more procedures using the three push-buttons. These push-buttons and indicators are also described in the Motherboard & I/O ExpansVarec Mark/Spaceion Module Configuration chapter.

Caution! Not all troubleshooting instructions are valid for all Communications Modules.

8.2 Troubleshooting the Tank Gate Interface

8.2.1 LED Displays under normal conditions

Operations are normal if the Run, I/O and On-line indicators are flashing. the table below represents the normal conditions for the Run, Output and On-line indicators.

Figure 8-1: LED Indicators

Indicator	Condition
Run	Flashes once every second.
Com	Toggles when the system is receiving data. Idle when not receiving data.
TXD	Every P011 causes the TXD LED to toggle
RXD	Lights when a response is received

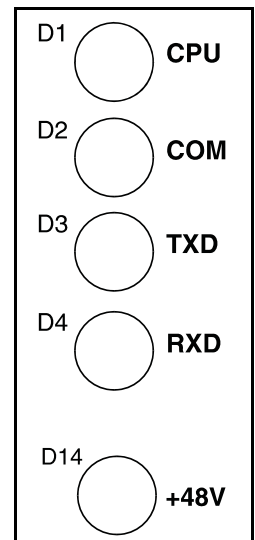

Run indicator

The RUN Indicator provides the single most important feedback of proper system operation. When the system functions properly, the RUN Indicator is constantly flashing at a 0.5Hz rate. If this indicator ever goes to a steady state condition, either on or off, some malfunction has occurred. In addition, relative processor loading can be determined by observing the RUN Indicator duty cycle. Under normal conditions, this indicator flashes once every second.

Communications indicator

The Communications indicator provides communication line status. When it is toggling, the system is exchanging data. As the system receives a valid message from the Host, this indicator toggles. If the indicator is idle, the system is off-line.

TXD/RXD LEDs

When these LEDs are flashing, the system is exchanging data between the Tank Gate Interface and any tank gauge.

8.2.2 LED Displays under Abnormal Conditions

The table below lists the abnormal conditions of the four indicator lights. From this table the user should be able to pinpoint the cause and derive a solution to the problem.

Indicator	Condition	Cause	Solution
Run	Does not flash (even after hard reset)	Bad database Bad main circuit board	Perform Hard Reset then reload database Replace main circuit board
	Steady ON/OFF	system failure	
Communication	Steady state	DIP switch setting	Check unit ID DIP switch setting: set ID number and reset system
		COM point	Check COM point with diagnostics terminal or ViewRTU
		COM parameters	Verify time-out, baud, and protocol parameters have the correct values set
		bad communications	Check for bad communication line, modem board or main circuit board
		wrong jumper settings	Check SW1 & SW2 for proper settings

8.2.3 Using the Tank Gate Interface Push-buttons

Reinitializing System Hardware

To reinitialize the system hardware

- Press the RESET Switch.

This action causes it to go to a known starting state. This switch may be pressed at any time; however, the following will also occur:

- Reinitialize System Hardware
- Clear Working Memory
- Reinitialize Data Base
- Reset All Timers
- Disable Outputs
- Enable Communications
- Present Sign-on Message to Diagnostic Terminal

8.2.4 Performing a Hard Reset

A 'Hard Reset' clears the Tank Gate Interface's database. The following procedure describes the steps necessary to perform a Hard Reset:

1. Set the ID DIP switch to 15 (all switches Closed/On). This action initiates the Hard Reset Procedure.

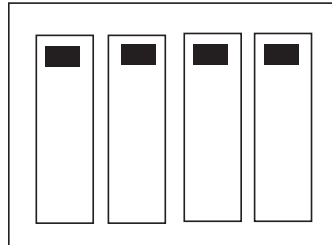

ID = 15

Figure 8-1: Set the ID DIP switch to 15

2. Press the Reset button

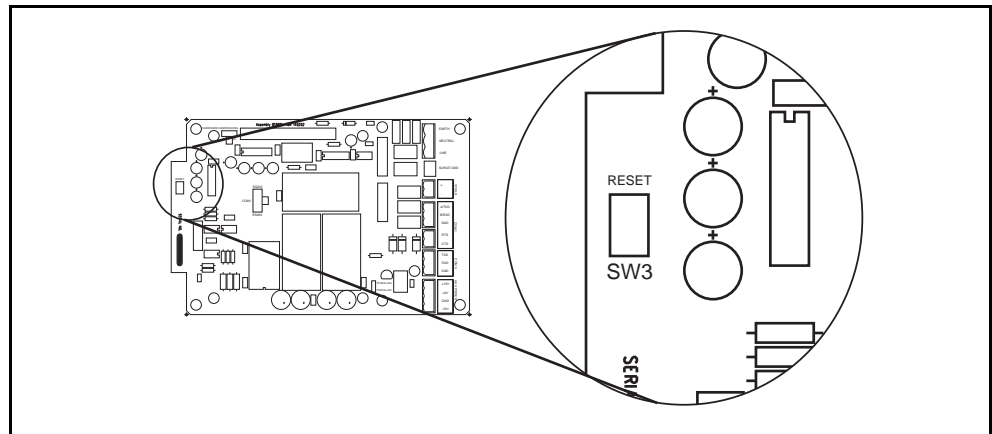
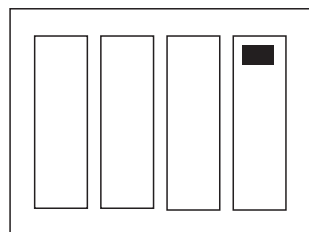

Figure 8-2: Switches SW3 on the Tank Gate Interface motherboard

3. The Tank Gate Interface will perform its memory test. When it has completed the memory test, all LEDs will be on.
4. Set the ID DIP Switch to the desired address (1-14). At this point, there is no further action required by the user.



ID = 1

Figure 8-3: Set the ID DIP switch to the desired addresses

5. The LEDs will light (and remain steady) to indicate the address. For example, if the ID DIP Switch is set to 1, LED D1 will be on. If the ID DIP Switch is set to 3, LEDs D1 and D2 will be on.

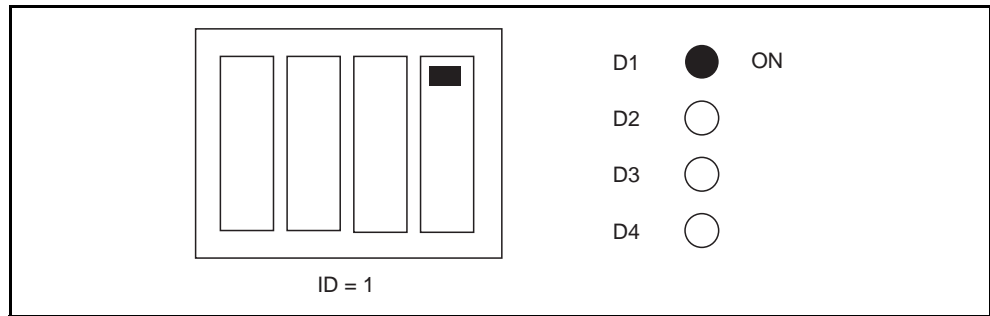

Figure 8-4: Address indication from the LEDs

6. After 10 seconds, the address of the Tank Gate Interface will be set to the ID DIP Switch setting. The LEDs will flash for 5 seconds to indicate that the address is about to be set.

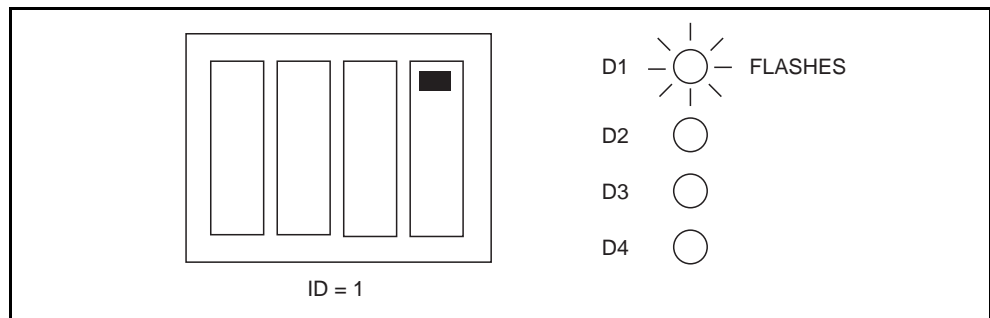

Figure 8-5: Set the ID addresses

7. After the address is set, the Tank Gate Interface will begin normal operation with a blank database:
 - CPU LED: Flashing once per second
 - COM LED: Toggles when communicating to PC
 - TXD: Off when there is no database. When tank gauges are being scanned, the TXD LED will flash
 - RXD: Off when there is no database. When tank gauges are being scanned, the RXD LED will flash when a response is received.

8.3 Maintenance

Field maintenance of the Tank Gate Interface is simplified by several built-in features. The modular design of the computer control system, in conjunction with quick-disconnect connectors, allows for on-site replacement of questionable components.

The following standard procedure can be used for repairing the Tank Gate Interface:

Replacing a defective component or module

- Turn off main power.
- Open the enclosure door. Remove the case cover of the Tank Gate Interface.
- Replace the defective component or module using the instruction supplied with the spare part.

- Replace and tighten the case cover.
- Turn on power and test with PC and ViewRTU.
- Close the enclosure door.

A Appendix - Order Codes

10	Interface Module		
	032	Dual RS-485 MODBUS™ Communications Interface Module	
	036	Dual RS-485 GSI ASCII Communications Interface Module	
	101	Varec Mark/Space Micro 4-wire (Varec 1800, 1900, 6500) Interface Module	
	111	Current Loop (Whessoe Bus) Interface Module	
	112	Current Loop (GPE) Interface Module	
	120	SAAB (TRL/2) Interface Module	
	140	Enraf (811, 802/812, 854, 873) Interface Module	
	150	L&J Tankway (MCG 1000, MCG 1500, MCG 2000) Interface Module	
	161	Prime Measurement (3500 ATG) Interface Module	
	171	Dual RS-232 Veeder Root (TLS 350) Interface Module	
20	Enclosure		
	A	No Enclosure (Note 1)	
	B	16x16x6 inch NEMA 4 enclosure	
30	Power Supply		
	0	No DC Power Supply (Note 1, 2)	
	1	120VAC input, 48VDC, 1 Amp Power Supply (Note 3)	
	2	240VAC input, 48VDC, 1 Amp Power Supply (Note 3)	
	3	120VAC input, 24VDC, 1 Amp Power Supply (Note 3, 4)	
	4	240VAC input, 24VDC, 1 Amp Power Supply (Note 3, 4)	
N83-			Complete product designation

Note 1: If 'No Enclosure' is selected, then 'No DC Power Supply' must be selected.

Note 2: Not available for Mark/Space or Current Loop Interface Modules unless 'No Enclosure' option selected

Note 3: Not available for SAAB, Enraf, L&J Tankway, Prime Measurement, or Veeder Root (TLS 350) Interface Modules

Note 4: Only available with Dual RS 485 Interface Modules with enclosure

