

This user guide is for controllers with the software version 1.1.0, 1.1.1 or 1.1.2.

Room controller HLS 44

HLS 44 is a versatile room controller for individual room temperature and VAV control applications. The controller can be connected to any system that supports Modbus RTU protocol via the RS-485 connection. The bus is galvanically isolated from the controller's other electronics. The controller has a display and touch buttons for commissioning the controller and adjusting the user parameters, temperature set point, for example.

The controller can control 0...10 V controlled actuators and thermal actuators.

The output Y1 is reserved for variable air volume (VAV) control.

The Y2 output controls the fan speed:

1. EC motor: directly with the 0...10 V signal
2. 3-speed fan: using the FCRY 3 relay module

The controller has day and night operating modes. The modes can be controlled by external card switch, PIR occupancy detector, over Modbus and from menu. The day mode can be activated temporarily for a specific time by touching the "man in house" button.

A demand based and energy saving ventilation can be implemented with a separate carbon dioxide measurement connected to the U1 input.



TECHNICAL DATA

Supply	24 Vac/dc (20...28 V), < 1 VA NOTE: Only the 0...10 V outputs work when using DC supply voltage.
Set point	Day mode: 18...26 °C, ±3 °C, factory setting 21 °C Night mode: Frost protection 8...50 °C, factory setting 17 °C
Accuracy (measuring inaccuracy)	±0.5 °C
Dead zone (Dz)	Day mode: 0.2...3 °C, factory setting 0.2 °C Night mode: 0...10 °C, factory setting 6 °C
Proportional band (Xp)	1...32 °C, factory setting 1 °C
Integration time (Tn)	50...50000 s, factory setting 300 s
Inputs	Internal temperature sensor 1 x ext. NTC10 or potential-free contact input (door or window contact or condensation switch) 1 x DI, potential-free contact input (day/night mode control) 1 x 0...10 V (CO ₂ measurement, external 0...10 V set point or 0...10 V temperature transmitter)
Outputs	4 x 0...10 Vdc (Heating/cooling actuators, VAV or Fan speed control) 2 x 24 Vac Triac outputs, < 1 A/output (thermal actuators)
Communication	RS-485 Modbus RTU, 9600/19200/38400/56000 bps, 8 data bits, parity none/odd/even, 1 stop bit (up to 247 devices per segment)
Display	LCD
Buttons	4 touch buttons
Wiring terminals	1.5 mm ²
Operating conditions	Humidity: 0...85 % rH non-condensing Temperature: 0...50 °C
Standards	2004/108/EY(EMC) EN61000-6-3: 2001 (Emission) EN61000-6-2: 2001 (Immunity)
Mounting	Wall surface or on the standard flush mounting box
Housing	IP20, ABS plastic
Dimensions (w x h x d)	87 x 86 x 32 mm

NOTE: The controller is available also with various button configurations.

WIRING



Device connection and commissioning can only be carried out by qualified professionals. Always make the connections while the power is switched off.

NOTE: The supply voltage potential must be the same in the controller and in the connected 24 Vac actuators.

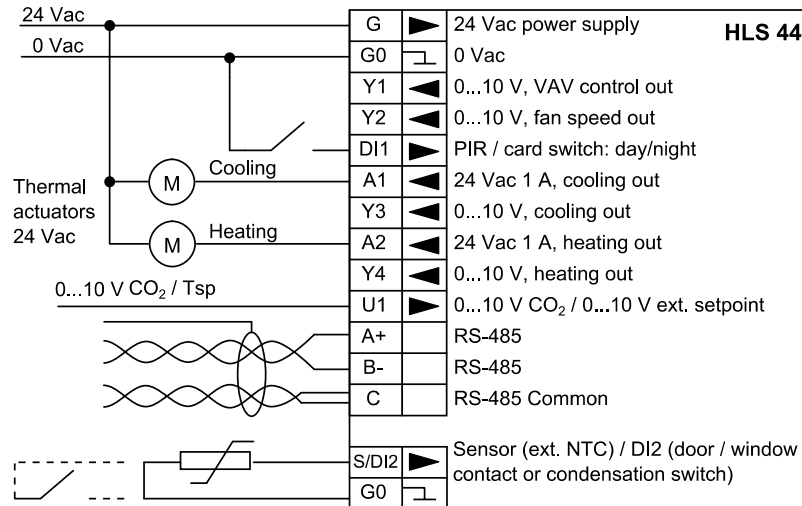

The maximum triac output current is 1 A. It is recommended to connect maximum of 4 thermal actuators to the same controller output. The total current consumption must not exceed 1 A.

The triac outputs are protected with fuses that can only be changed by the manufacturer.

NOTE: Unused inputs and outputs can also be used for transferring other measuring and control information over the Modbus.

OPERATING AFTER A POWER FAILURE

- The controller settings remain over the power failure.
- Overdrives made over the Modbus are cleared during the power failure.

USER MODE

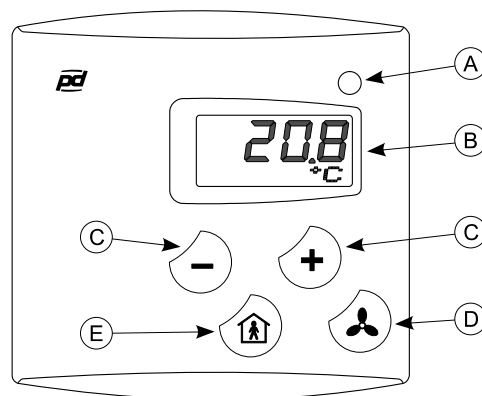

- A. Indicator light
 - red = heating
 - green = cooling
- B. Display
 - temperature or set point
 - fan speed
- C. Set point change buttons

The set point changes in larger steps when the buttons are quickly pressed several times in a row.
- D. Fan speed control button
 - 0 = STOP
 - 1 = Speed 1
 - 2 = Speed 2
 - 3 = Speed 3
 - A = AUTO
- E. "Man in house" button

COMMISSIONING

NOTE: All the settings and parameters must be checked during the commissioning. This way you can ensure the correct function in the selected application.

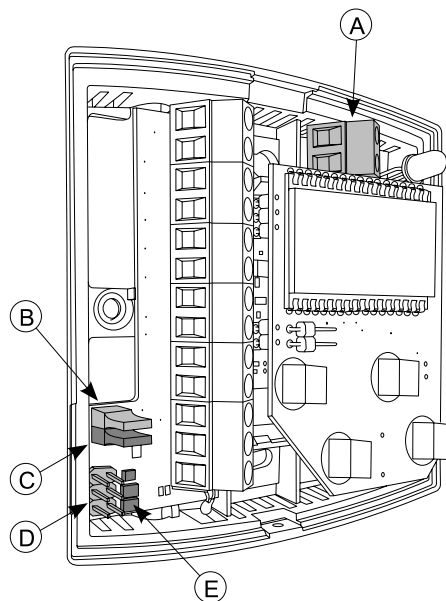

- A. Terminals for external sensor or DI contact
- B. Bus termination (120 Ω)
 - closed = terminated
 - open = no termination
- C. Configuration mode selector
 - closed = configuration mode
 - open = user mode (factory setting)
- D. Terminal for HLS 44-SER commissioning tool
- E. Indicator lights
 - green PWR = supply voltage OK
 - yellow TX = transmission from controller
 - yellow RX = bus activity

Every controller must have an unique bus address (1...247). All controllers inside the same segment can be controlled by sending a common command to address zero (broadcast). The function can be used for testing during commissioning or common control of the day/night mode changes.

The controller settings can be supplied with controller buttons or by using the HLS 44-SER commissioning tool. The commissioning tool settings can be loaded to the controller or the controller settings can be loaded to the configuration tool and then to other controller.

Configuration through the menu:

1. Remove the cover.
2. Set configuration mode selector to closed position.
3. Make the settings required by the process.
4. Set the configuration mode selector to open position.
The controller returns to the user mode.

For configuration with the HLS 44-SER commissioning tool, see the commissioning tool instructions.

HLS 44-SER

There is four pre-programmed editable parameter profiles, one fixed configuration (=factory settings) and five memory slots for user defined parameter profiles in the commissioning tool. The pre-programmed profiles 1...3 work with both HLS 44 and HLS 44-V controllers and the profile 4 works only in the HLS 44-V controller.

The pre-programmed parameter profiles are:

1. Heating with radiator and cooling with beam
2. Heating and cooling with fan coil unit
3. Heating with radiator, cooling with VAV and beam, demand based ventilation (CO₂)
4. Heating by radiator, cooling with beam, on/off boosting damper control and light control

MENU

Menu is activated by setting the configuration mode selector to the closed position. You can proceed in the menu by touching the and buttons. The values can be changed with the and buttons. The value is accepted with the button. The following menu structure contains the factory settings.

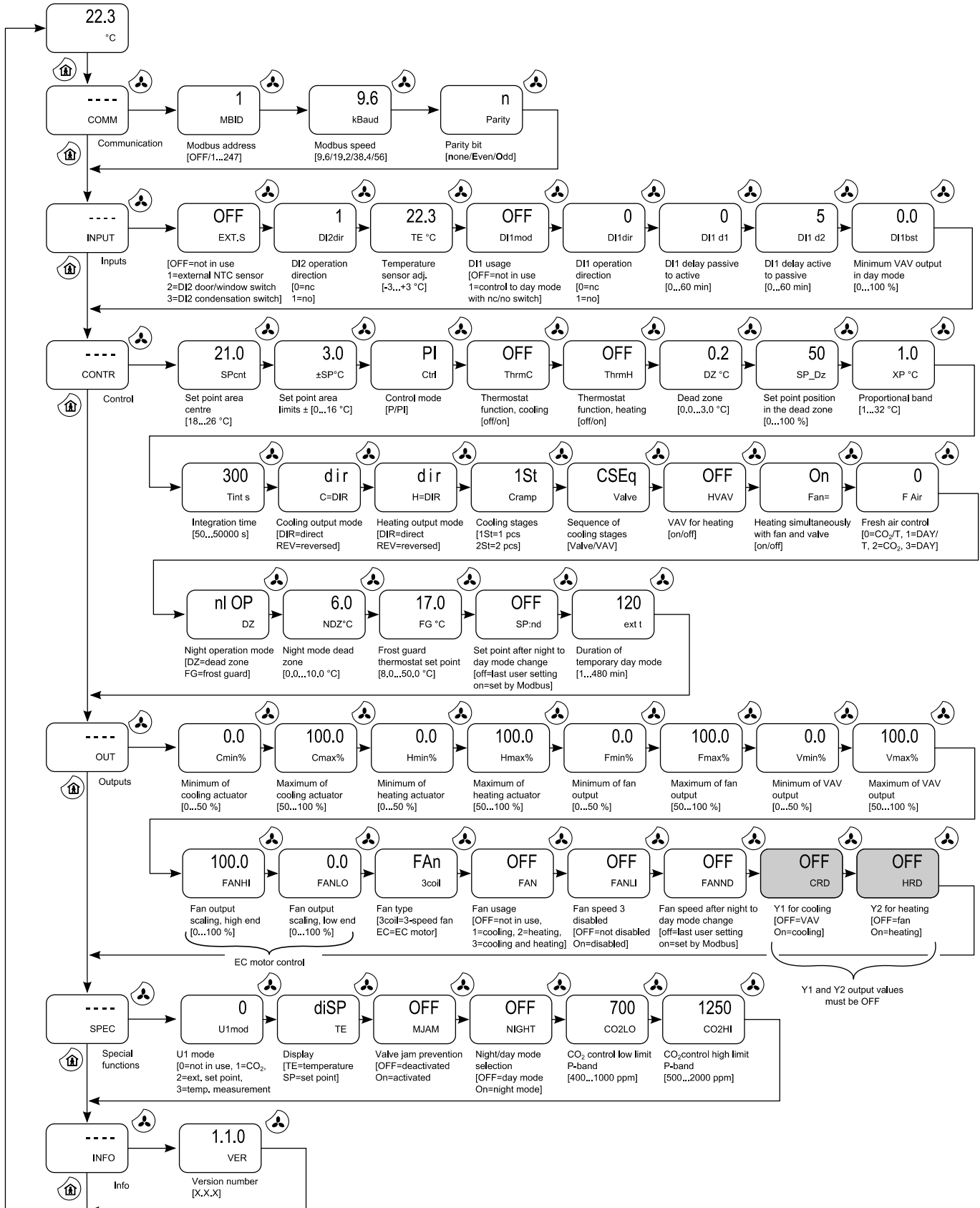

CONTROL METHODS

Heating and 1-stage cooling

Parameter	Description	choose
Cramp	Cooling stages	1St
FAN	Fan usage	3

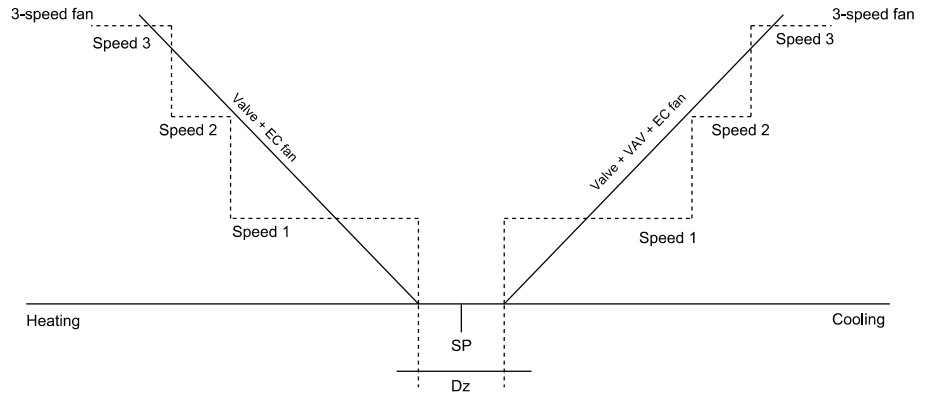

Heating and 2-stage cooling

Parameter	Description	choose
Cramp	Cooling stages	2St
CSEq	Sequence of cooling stages	Valve
FAN	Fan usage	3

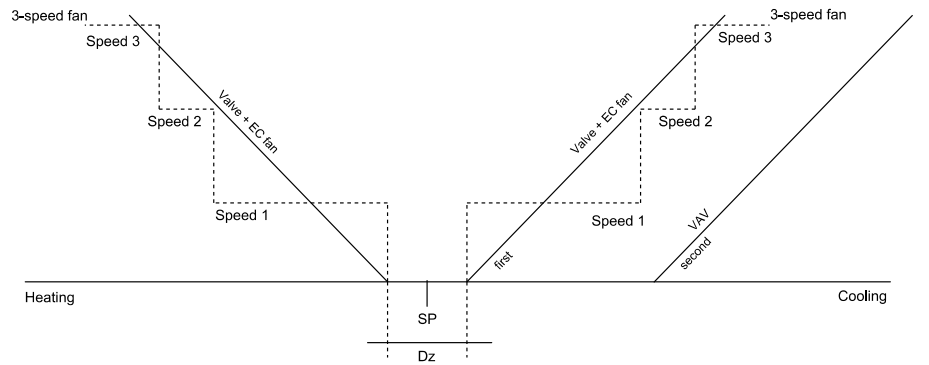

Heating and 1-stage cooling, valve opens before the fan speed increases

Parameter	Description	choose
Cramp	Cooling stages	1St
Fan=	Fan stage simultaneously with the valve stage	OFF
FAN	Fan usage	3
FANLO	Fan output scaling, low end *)	e.g. 20%

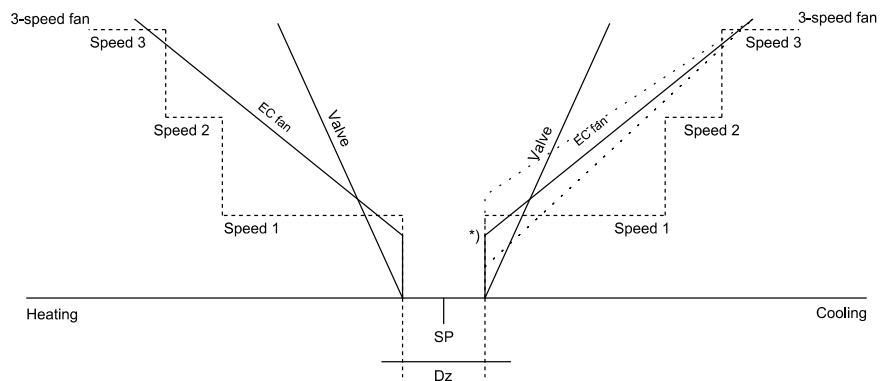

VAV heating and cooling

Parameter	Description	choose
HVAV	VAV heating NOTE: The heating stage order is always the following: 1. Valve 2. VAV	On
Cramp	Cooling stages	2St
CSEq	Sequence of cooling stages	Valve
Vmin%	Minimum of VAV output *)	e.g. 20%
FAN	Fan usage	OFF

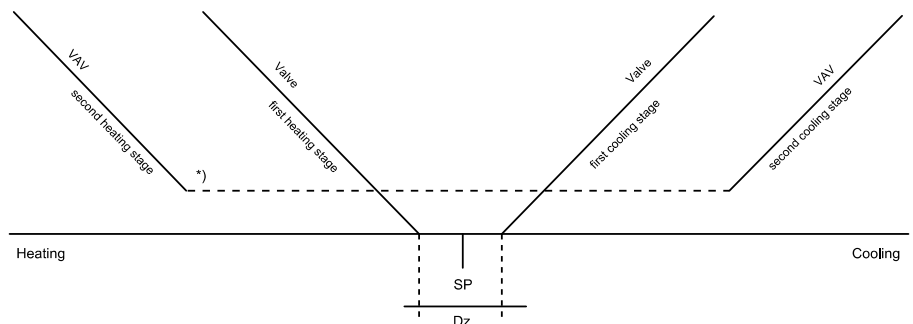

PROFILE 1: HEATING WITH RADIATOR AND COOLING WITH BEAM

Principle diagram:

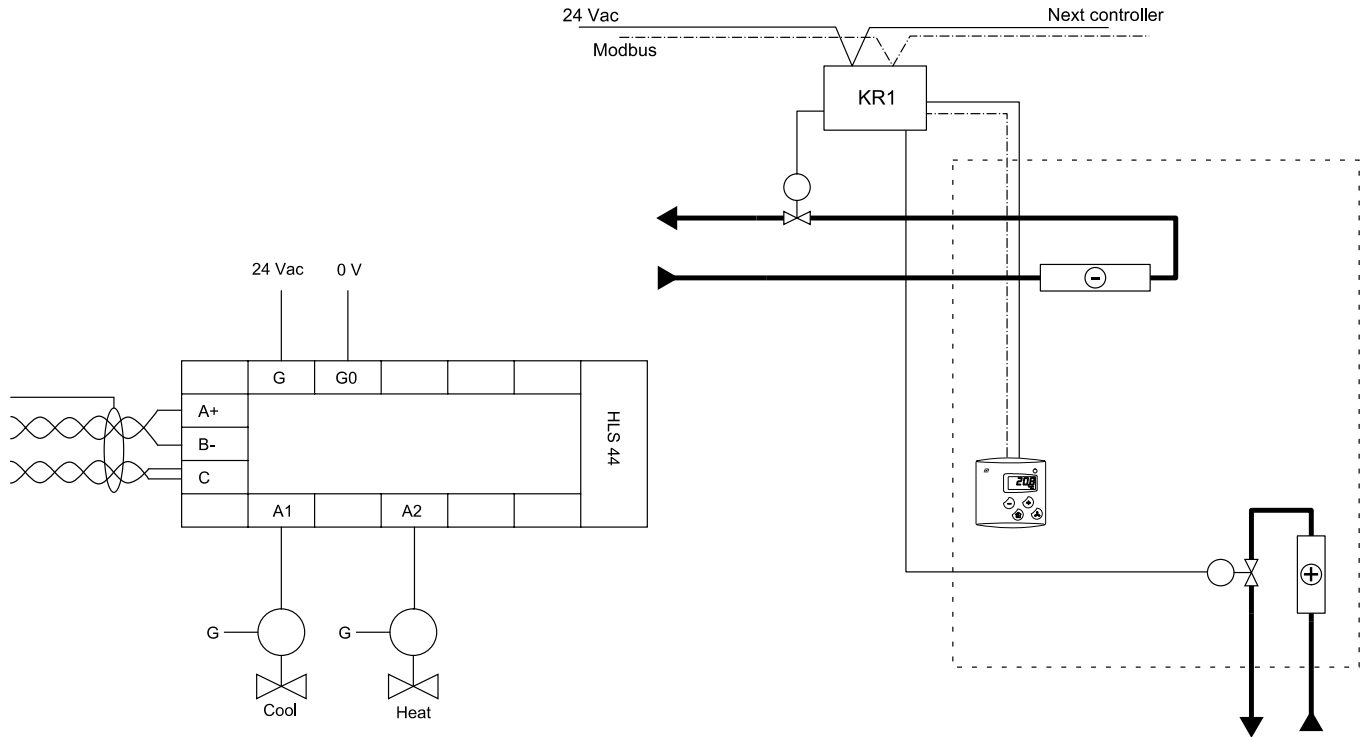

Input	D11	U1	S/D12

Output	Y1	Y2	A1	A2	Y3	Y4
Thermal actuator			x	x		

Note the following parameters:

Parameter	Modbus register	Description	factory setting	Min	Max	
Cramp	17	Cooling stages	1St	1St	2St	1St = 1 stage, 2St = 2 stages
MJAM	22	Valve jam prevention	OFF	ON	OFF	Valves can jam when they are kept on the same position for a long time. The valve jam prevention function can be activated in these kind of situations. When the MJAM parameter is in "ON" position, valves are opened and closed for 5 minutes once a day.

PROFILE 2: HEATING AND COOLING WITH FAN COIL UNIT

Principle diagram:

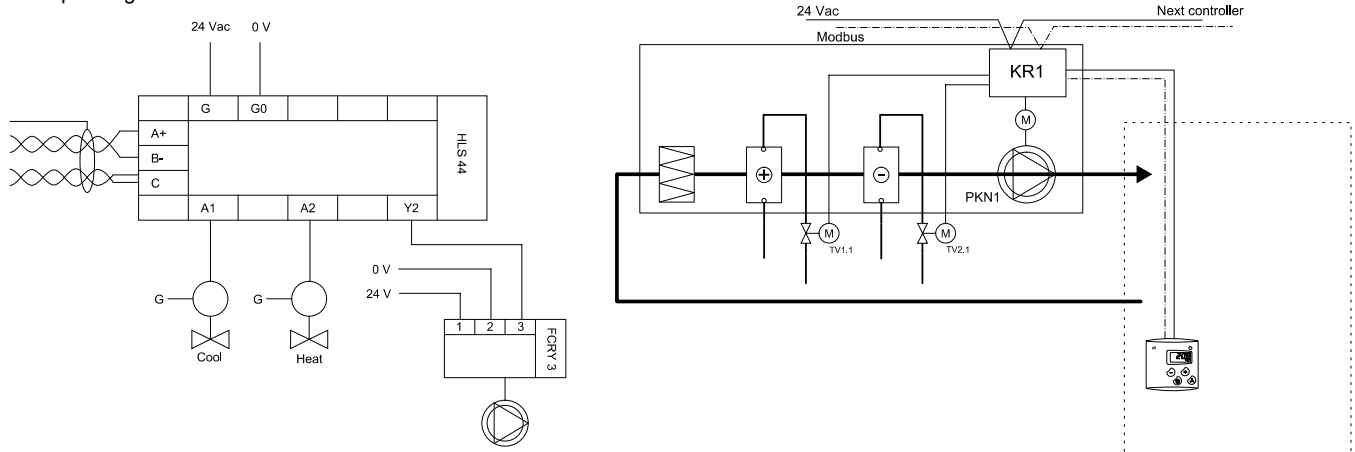

Input	DI1	U1	S/DI2

Output	Y1	Y2	A1	A2	Y3	Y4
Thermal actuator			x	x		
FCRY 3 relay or EC fan		x				

Note the following parameters:

Parameter	Modbus register	Description	factory setting	Min	Max	
EXT.S	40009	External temperature sensor / DI2 contact input	OFF	OFF	3	OFF=not in use, 1= external NTC sensor, 2=DI2 door/window contact (prevents both heating and cooling), 3=DI2 condensation switch (prevents cooling)
Cramp	17	Cooling stages	1St	1St	2St	1St = 1 stage, 2St = 2 stages
CSEq	18	Sequence of cooling stages	Valve	Valve	VAV	Valve = valve first, VAV = VAV first
Fan=	19	Fan stage simultaneously with the valve stage	On	Off	On	On = valve and fan stages are working simultaneously, Off = first valve stage, then fan stage
Fmax%	40033	Maximum fan output	100.0	50.0	100.0	To avoid noise coming from fan, the maximum fan speed output (EN fan) can be limited.
FANHI	40036	Fan output scaling, high end	100	0	100	The high end of the scaled EC fan control signal (0...10 V)
FANLO	40037	Fan output scaling, low end	0	0	100	The low end of the scaled EC fan control signal (0...10 V)
FAn	23	Fan type	3coil	3coil	EC	3coil = 3-speed fan, EC = EC fan
FAN	40038	Fan usage	OFF	OFF	3	OFF=OFF, 1= cooling, 2= heating, 3= both cooling and heating
FANLI	24	Fan speed 3 disabled	ON	OFF	ON	When FANLI=ON, the fan speed 3 in the automatic mode is disabled (e.g. due the noise). However, the user can manually engage the speed 3. When FANLI=ON, the fan speed 3 is allowed in the automatic mode.

Fan control

- The fan can be 3-speed or 0...10 V -controlled (EC motor). In the manual mode, the EC motor works so that the switch position is 0 = 0 %, 1 = 33 %, 2 = 66 % and 3 = 100 % of the scaled control signal.
- With the FCRY 3 relay module connected to the Y2 output you can control the speed of fan coil or 3-speed fan. For example, when the FAN parameter is '2' and Fan= parameter is 'ON', the fan works like following:
 - Temperature reaches the set point (DZ lower end), the valve closes and after 5 minutes the fan stops.
 - Temperature goes below the DZ lower limit, the valve starts to open and the fan is controlled to the speed 1 (Y2 = 3 V)
 - The temperature still decreases, valve opens over 70 %. The fan is directed to the speed 2 (Y2 = 6 V)
 - The temperature still decreases, valve opens over 90 %. The fan is directed to the speed 3 (Y2 = 10 V)

Accordingly in cooling situation, when the FAN parameter is "1", the controller functions according to the cooling demand (temperature increases).

See page 5, Heating and 1-stage cooling

Valve opening before increasing the fan speed

- When the Fan= parameter is 'ON', the EC fan that is connected to the Y2 output works simultaneously with the heating and/or cooling valve. The fan starts when the valve starts to open and when the valve is fully open the fan works also in full speed. The fan speed is controlled linearly between the low and high limits.

The fan works for 5 minutes after the valve is fully closed using the speed defined by FANLO parameter.

See page 5, Heating and 1-stage cooling

- When the Fan= parameter is 'OFF', the 3-speed fan works at speed 1 and the valve is driven fully open. The fan is then controlled to the speed 2 (66 %) or 3 (100 %) if needed.

See page 5, Heating and 1-stage cooling, valve opens before the fan speed increases

PROFILE 3: HEATING WITH RADIATOR, COOLING WITH VAV AND BEAM, DEMAND BASED VENTILATION (CO₂)

Principle diagram:

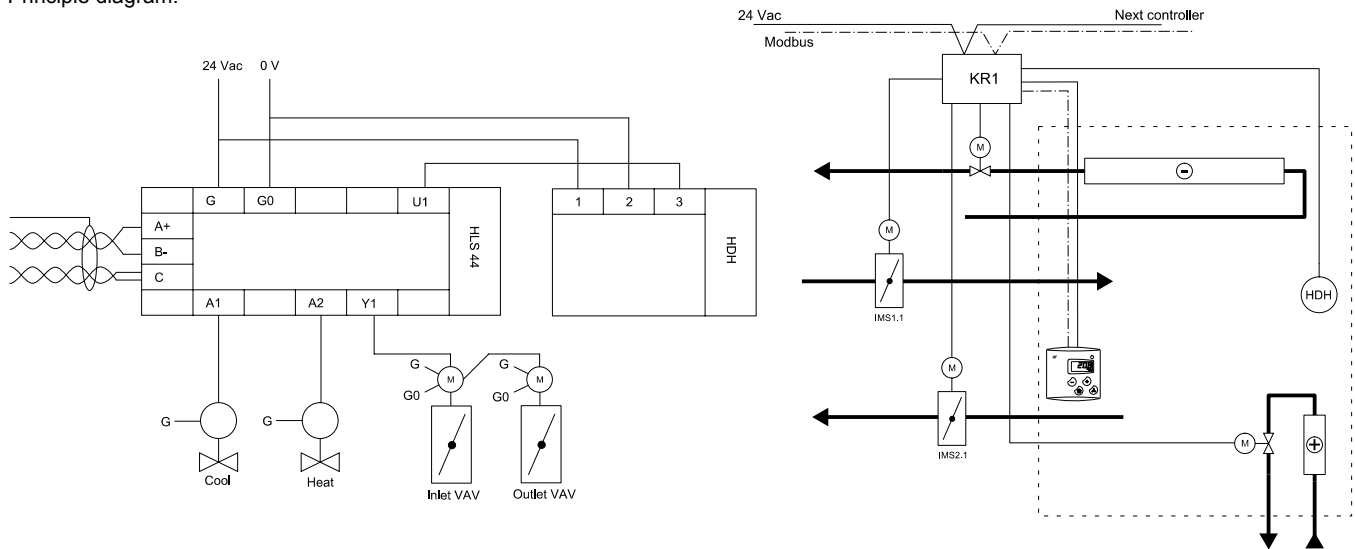

Input	DI1	U1	S/DI2
HDH CO ₂ transmitter		x	
(PIR occupancy)			(x)

Output	Y1	Y2	A1	A2	Y3	Y4
Thermal actuator			x	x		
VAV	x					

Note the following parameters:

Parameter	Modbus register	Description	factory setting	Min	Max	
Cramp	17	Cooling stages	1St	1St	2St	1St = 1 stage, 2St = 2 stages
CSEq	18	Sequence of cooling stages	Valve	Valve	VAV	Valve = valve first, VAV = VAV first
MJAM	22	Valve jam prevention	OFF	ON	OFF	Valves can jam when they are kept on the same position for a long time. The valve jam prevention function can be activated in these kinds of situations. When the MJAM parameter is in "ON" position, valves are opened and closed for 5 minutes once a day.
Vmin%	40034	Minimum of VAV output	0.0	0.0	50.0	Minimum of VAV output The minimum level of fresh air level can be set to ensure the adequate ventilation, for example to remove moisture in situations where the ventilated space is not occupied.

If you use CO₂ measurement or occupancy detectors, note the following parameters:

Parameter	Modbus register	Description	factory setting	Min	Max	
U1mod	40027	U1 mode	0	0	3	0= not in use, 1=CO ₂ measurement, 2= external set point, 3= temp. measurement with 0...10 V transmitter (NOTE: External sensor is not available if the 0...10 V transmitter is selected)
CO2LO	40039	Low limit P-band for CO ₂ control	700	400	1000	Low limit P-band for CO ₂ control
CO2HI	40040	High limit P-band for CO ₂ control	1250	500	2000	High limit P-band for CO ₂ control
F Air	40018	Fresh air control	0	0	3	0=CO ₂ / T, 1=DAY/T, 2=CO ₂ 3=DAY
DI1bst	40026	Minimum VAV output in day mode	0 %	0 %	100 %	Minimum VAV output when the controller is in the day mode

Improving the fresh air usage according to the carbon dioxide level

A CO₂ concentration (and temperature) controlled ventilation can be implemented by connecting a CO₂ transmitter to the U1 input. The control area can be defined by setting the low limit (CO2LO; factory setting 700 ppm) and high limit (CO2HI; factory setting 1250 ppm).

CO₂ concentration based fresh air usage improvement requires following:

- F Air parameter is "0" or "2"
- U1mod parameter is "1" (CO₂ measurement)
- CO₂ transmitter is connected to the U1 input

NOTE: When the F Air parameter is "0", the Y1 output is defined as maximum selection according to the CO₂ concentration or temperature.

Improving fresh air usage according to the day mode

As an alternative, the fresh air supply can be improved according to the day mode. Day mode based fresh air usage improvement requires following:

- F Air parameter is "1" or "3"
- Day mode control: PIR, card switch, Modbus or "man in house" button
- The DI1bst parameter (minimum VAV output when the controller is in the day mode) has a non-zero value (for example 80 %)

NOTE: When the F Air parameter is "1", the Y1 output is defined as maximum selection according to the previously mentioned controls or temperature.

THERMOSTAT FUNCTION

By choosing the thermostat mode, the actuators can be controlled by a thermostat type control. Thermostat mode can be activated either for cooling or heating side or for both.

- When using the thermostat mode in the heating side, the heating valve opens fully when the temperature falls below the DZ lower limit. The heating valve closes when the temperature reaches the set point (SP).
- When using the thermostat mode in the cooling side, the cooling valve opens fully when the temperature rises over the DZ higher limit. The cooling valve closes when the temperature reaches the set point (SP).

In the night mode the controller works according to the chosen function, either in thermostat mode or in frost guard mode.

The thermostat mode affects to the outputs A1, A2, Y3 and Y4.

ON/OFF actuator functions:

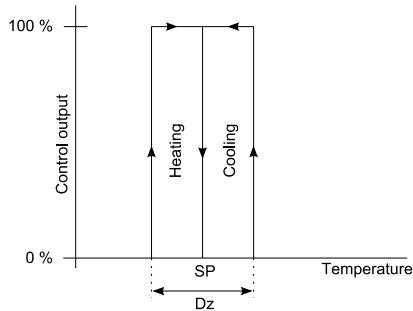

Input	DI1	U1	S/DI2

Output	Y1	Y2	A1	A2	Y3	Y4
Thermal actuator			x	x		
VAV	(x)					
FAN		(x)				

Note the following parameters:

Parameter	Modbus register	Description	factory setting	Min	Max	
EXT.S	40009	External temperature sensor / DI2 contact input	OFF	OFF	3	OFF=not in use, 1= external NTC sensor, 2=DI2 door/window contact (prevents both heating and cooling), 3=DI2 condensation switch (prevents cooling)
SPcnt	40011	Centre of user set point area	21.0	18.0	26.0	Centre of user set point area
±SP °C	40012	Use set point area limits	±3.0	±0	±16	The user can adjust the set point within these limits.
DZ °C	40014	Dead zone	0.2	0.0	3.0	Used as a hysteresis in the thermostat mode.
nl OP	20	Night operation mode	DZ	DZ	FG	DZ = dead zone, FG = frost guard mode
FAN	40038	Fan usage	OFF	OFF	3	OFF=OFF, 1= cooling, 2= heating, 3= both cooling and heating
Fmin%	40032	Minimum fan output	0.0	0.0	50.0	
Fmax%	40033	Maximum fan output	100.0	50.0	100.0	
Vmin%	40034	Minimum of VAV output	0.0	0.0	50.0	
Vmax%	40035	Maximum of VAV output	100.0	50.0	100.0	
ThrmC	29	Thermostat function, cooling	OFF	OFF	On	OFF = P/PI controller, On = thermostat mode
ThrmH	30	Thermostat function, heating	OFF	OFF	On	OFF = P/PI controller, On = thermostat mode

ELECTRIC HEATER CONTROL

The controller can control an electric heater by using a solid state relay PR 50/440 between the A2 output and the heater. The relay must be equipped with a PR 50Vac auxiliary card.

IMPORTANT: The controller is not equipped with a heater overheating protector. The overheating protection must be included in the heater itself. The overheating alarm signal can be read by DI input, but the signal does not deactivate the heater control.

The overheating alarm signal can be connected to the DI1 or DI2 input, and the signal can then be read via the Modbus. DI input must be set to "not in use" position (DI1mod = 0 or EXT.S = OFF).

Input	DI1	U1	S/DI2
Overheating alarm	(x)		(x)

Output	Y1	Y2	A1	A2	Y3	Y4
Thermal actuator			x			
24 Vac controlled solid state relay				x		

Note the following parameters:

Parameter	Modbus register	Description	factory setting	Min	Max	
EXT.S	40009	External temperature sensor / DI2 contact input	OFF	OFF	3	OFF=not in use, 1= external NTC sensor, 2=DI2 door/window contact (prevents both heating and cooling), 3=DI2 condensation switch (prevents cooling)
DI2dir	28	DI2 operation direction (nc/no)	1	0	1	0 = nc, 1 = no
DI1mod	40021	DI1 mode	0	0	1	0= not in use, 1= control to day mode with a nc/no switch connected to the DI1 input
DI1dir	40022	DI1 operation direction (nc/no)	0	0	1	in the night mode: 0 = nc, 1 = no

USAGE AND FUNCTIONS OF THE DI1 DIGITAL INPUT

DI1 input can be used to control the controller to the day/night mode by using a home/away switch, card reader or motion detector.

The DI1 input can be used to read other device statuses via the Modbus if the input is not needed for the room control.

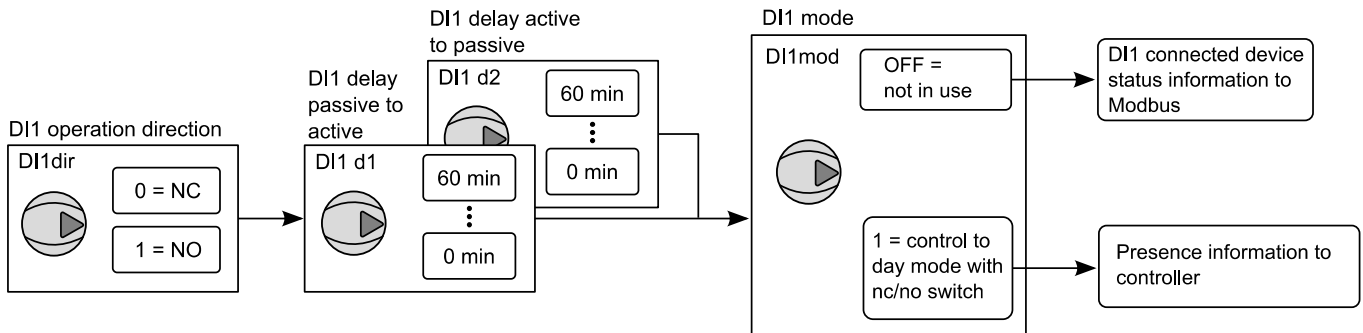

Parameter	Modbus register	Description	factory setting	Min	Max	
DI1mod	40021	DI1 mode	0	0	1	0= not in use, 1= control to day mode with a nc/no switch connected to the DI1 input
DI1dir	40022	DI1 operation direction (nc/no)	0	0	1	in the night mode: 0 = nc, 1 = no
DI1 d1	40023	DI1 delay passive to active	0	0	60	The delay in minutes, when moving from night mode to day mode
DI1 d2	40024	DI1 delay active to passive	5	0	60	The delay in minutes, when moving from day mode to night mode

USAGE AND FUNCTIONS OF THE DI2 DIGITAL INPUT

DI2 input can be used to control the controller by using a door/window contact or dew point guard with relay output.

In the door/window contact case the controller prevents cooling and heating when the door or window is open. This way the energy loss and cooling beam condensation problems can be avoided.

In the condensation switch case, the cooling is prevented when the contact activates.

The DI2 input can be used to read other device statuses via the Modbus if the input is not needed for the room control.

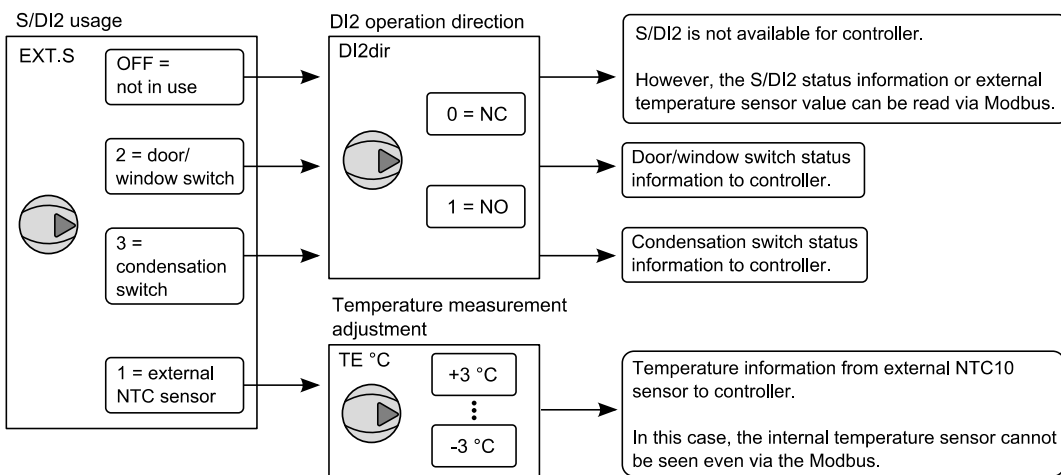

Note the following parameters:

Parameter	Modbus register	Description	factory setting	Min	Max	
EXT.S	40009	External temperature sensor / DI2 contact input	OFF	OFF	3	OFF=not in use, 1= external NTC sensor, 2=DI2 door/window contact (prevents both heating and cooling), 3=DI2 condensation switch (prevents cooling)
DI2dir	28	DI2 operation direction (nc/no)	1	0	1	0 = nc, 1 = no
TE °C	40010	Temperature sensor adjustment	0.0	-3.0	+3.0	The temperature measurement can be adjusted if needed NOTE: Eliminate all error factors that can affect to the temperature measurement before changing this parameter. The parameter cannot be reset to the factory value.

CONTROL TO THE DAY AND NIGHT MODES

- NIGHT parameter is "OFF": The controller is in fixed day mode.
- NIGHT parameter is "On": The controller moves to day mode when the first control requests the day mode. The controller moves to the night mode when the last control requests the night mode.

Example:

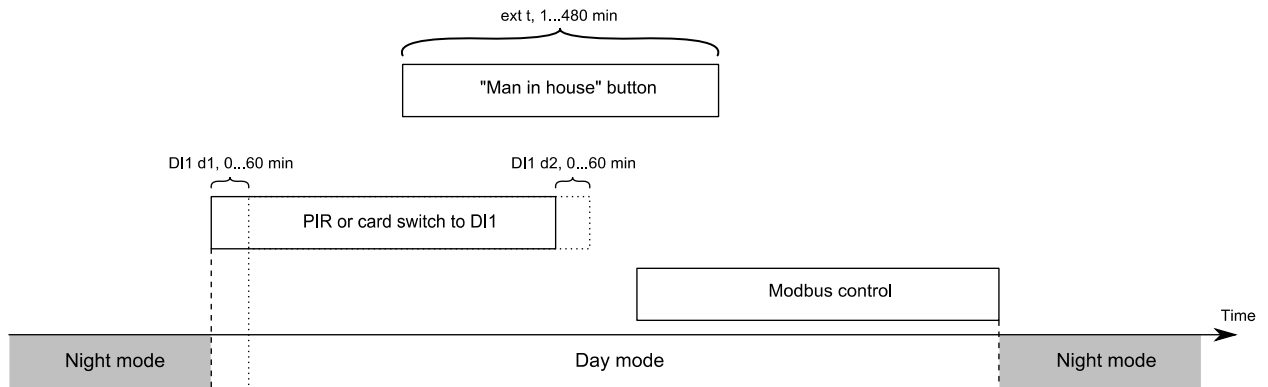

When the controller moves to the day mode, following happens:

1. The fresh air usage is improved (DI1bst parameter defines the improvement amount, 0...100 %). Fresh air usage improvement can be prevented by setting the DI1bst parameter value to 0 %.
2. The temperature set point defined by the SP:nd parameter becomes effective.
3. The day mode dead zone becomes effective and the controller moves from possible frost guard mode to controlling mode.

Note the following parameters:

Parameter	Modbus register	Description	factory setting	Min	Max	
EXT.S	40009	External temperature sensor / DI2 contact input	OFF	OFF	3	OFF=not in use, 1= external NTC sensor, 2=DI2 door/window contact (prevents both heating and cooling), 3=DI2 condensation switch (prevents cooling)
DI2dir	28	DI2 operation direction (nc/no)	1	0	1	0 = nc, 1 = no
DI1mod	40021	DI1 mode	0	0	1	0= not in use, 1= control to day mode with a nc/no switch connected to the DI1 input
DI1dir	40022	DI1 operation direction (nc/no)	0	0	1	in the night mode: 0 = nc, 1 = no
DI1 d1	40023	DI1 delay passive to active	0	0	60	The delay in minutes, when moving from night mode to day mode
DI1 d2	40024	DI1 delay active to passive	5	0	60	The delay in minutes, when moving from day mode to night mode
ext t	40025	Duration of temporary day mode, minutes	120	1	480	
DI1bst	40026	Minimum VAV output in day mode	0 %	0 %	100 %	Minimum VAV output when the controller is in the day mode
SP:nd	21	The effective set point after night mode to day mode change	OFF	OFF	On	OFF = The last value set by the user On = The value from Modbus
NIGHT	14	Night/day mode selection	OFF	OFF	On	OFF = the controller is in fixed day mode, On = the controller is in the night mode if not separately controlled to the day mode.

USING THE EXPANDED DEAD ZONE IN THE NIGHT MODE

With the expanded dead zone you can save energy by allowing lower temperature and ventilation. It is also possible to set the night dead zone to a smaller value than the day dead zone.

When the nI OP parameter is "DZ", the controller works just like in the day mode but uses the night dead zone. The night dead zone is defined with the NDZ°C parameter.

Day mode:

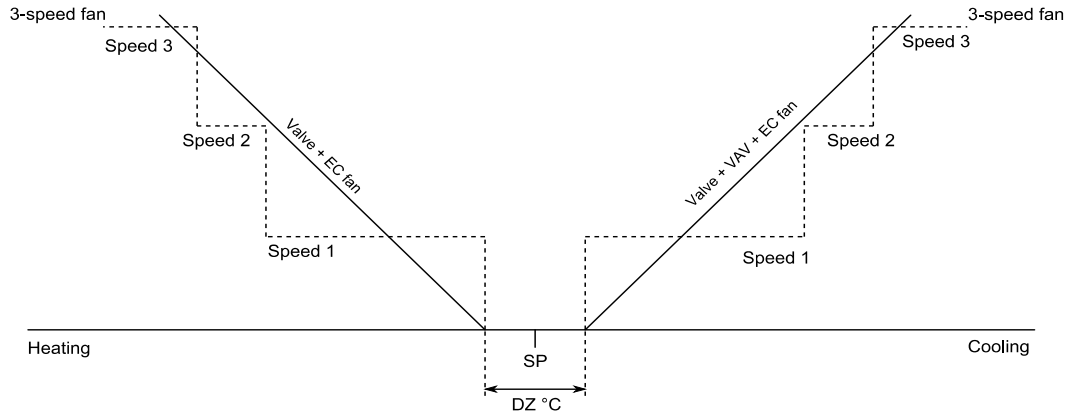

Night mode:

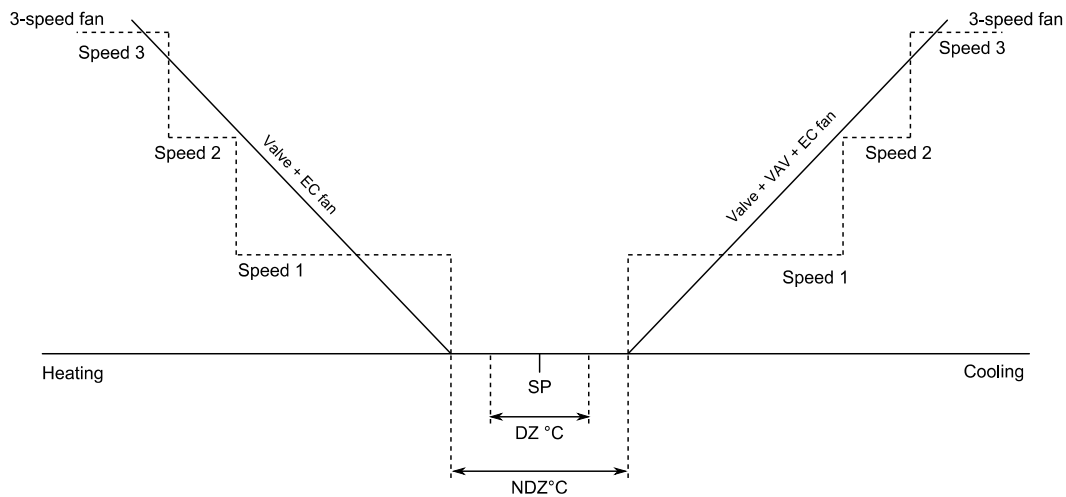

Note the following parameters:

Parameter	Modbus register	Description	factory setting	Min	Max	
EXT.S	40009	External temperature sensor / DI2 contact input	OFF	OFF	3	OFF=not in use, 1= external NTC sensor, 2=DI2 door/window contact (prevents both heating and cooling), 3=DI2 condensation switch (prevents cooling)
nI OP	20	Night operation mode	DZ	DZ	FG	DZ = dead zone, FG = frost guard mode
NDZ°C	40019	Night mode dead zone	6.0	0.0	10.0	

ASYMMETRIC DEAD ZONE

The dead zone centre relation to the temperature set point can be adjusted with the SP_Dz parameter (0...100 %) according to the following figure.

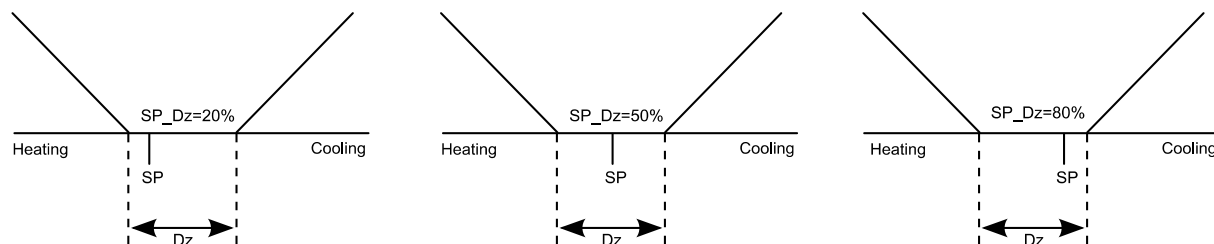

FUNCTIONING AS A FROST GUARD IN THE NIGHT MODE

When the temperature drops below the frost guard set point (FG °C parameter), the heating valve opens and the fan starts (the FAN parameter must be "2" or "3") at speed 1. The EC motor control signal is 33 %.

When the temperature rises 2 °C over the set point (FG °C parameter), the heating valve closes and the fan stops. The procedure repeats until the controller moves to day mode.

Day:

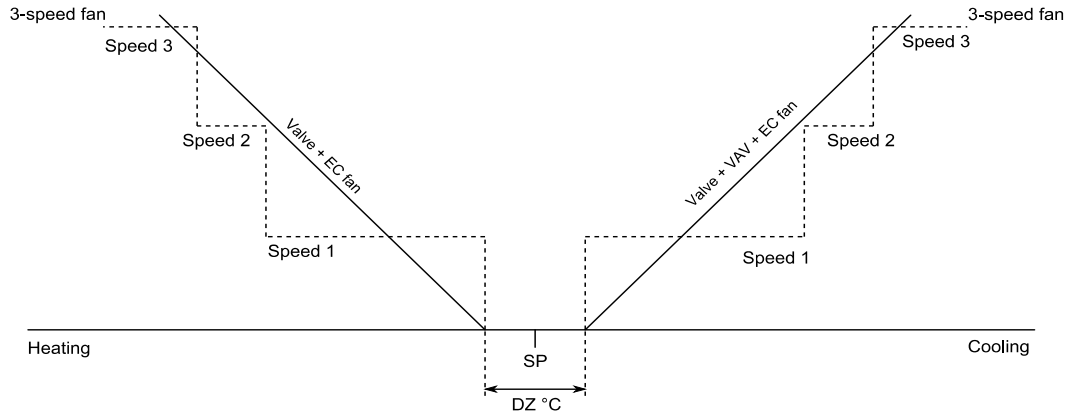

Night:

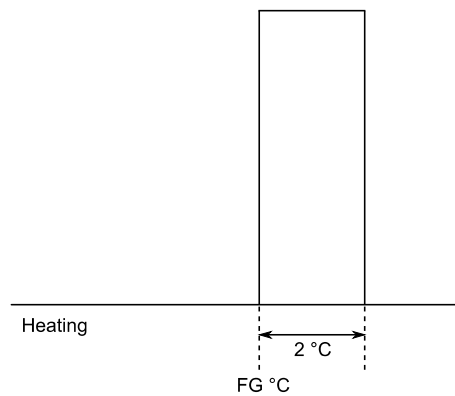

Note the following parameters:

Parameter	Modbus register	Description	factory setting	Min	Max	
EXT.S	40009	External temperature sensor / DI2 contact input	OFF	OFF	3	OFF=not in use, 1= external NTC sensor, 2=DI2 door/window contact (prevents both heating and cooling), 3=DI2 condensation switch (prevents cooling)
nl OP	20	Night operation mode	DZ	DZ	FG	DZ = dead zone, FG = frost guard mode
FG °C	40020	Frost guard thermostat set point	17.0	8.0	50.0	

TEMPERATURE SET POINT

The temperature set point can be one of the following:

1. Set with the controller buttons (parameters SPcnt and \pm SP °C).
2. Set by external 0...10 V signal (U1mod parameter must be "2").
The external set point 0...10 V signal range is the same as the set point area defined in the menu (parameters SPcnt and \pm SP °C).
3. Set via the Modbus.
4. The frost guard set point (FG °C parameter) in the night mode, if the frost guard mode is selected to the night mode (nl OP parameter is "FG").

The change from night mode to day mode affects also to the temperature set point. With the Sp:nd parameter you can select the set point either to be the latest user given value or to be read via Modbus. The user given value can be the 0...10 V signal connected to the U1 input or the value set by the controller buttons.

Parameter	Modbus register	Description	factory setting	Min	Max	
SPcnt	40011	Centre of user set point area	21.0	18.0	26.0	Centre of user set point area
\pm SP °C	40012	User set point area limits \pm °C	\pm 3.0	\pm 0	\pm 16	The user can adjust the set point within these limits.
SP_Dz	40015	Set point position in dead zone	50	0	100	
FG °C	40020	Frost guard thermostat set point	17.0	8.0	50.0	
SP:nd	21	The effective set point after night mode to day mode change	OFF	OFF	On	OFF = The last value set by the user On = The value from Modbus
U1mod	40027	U1 mode	0	0	3	0= not in use, 1=CO ₂ measurement, 2= external set point, 3= temp. measurement with 0...10 V transmitter (NOTE: External sensor is not available if the 0...10 V transmitter is selected)

SENSOR SELECTION

The temperature information can be imported to the controller by using following methods:

1. Controller inner temperature measurement (EXT.S parameter is "0", "2" or "3")
2. External temperature measurement with NTC10 sensor (EXT.S parameter is "1")
3. External 0...10 V temperature measurement (U1mod parameter is "3")

NOTE: The external 0...10 V temperature transmitter range must be 0...+50 °C.

The set point can be read from one controller and then fed to other controllers in cases where multiple controllers are located in the same space.

Note the following parameters:

Parameter	Modbus register	Description	factory setting	Min	Max	
EXT.S	40009	External temperature sensor / DI2 contact input	OFF	OFF	3	OFF=not in use, 1= external NTC sensor, 2=DI2 door/window contact (prevents both heating and cooling), 3=DI2 condensation switch (prevents cooling)
TE °C	40010	Temperature sensor adjustment	0.0	-3.0	3.0	The temperature measurement can be adjusted if needed NOTE: Eliminate all error factors that can affect to the temperature measurement before changing this parameter. The parameter cannot be reset to the factory value.
U1mod	40027	U1 mode	0	0	3	0= not in use, 1=CO ₂ measurement, 2= external set point, 3= temp. measurement with 0...10 V transmitter (NOTE: External sensor is not available if the 0...10 V transmitter is selected)

OUTPUT LIMITATIONS

It is possible to limit minimum and maximum values of each output separately. The controller does not drive the output outside the given limits. For example, setting the heating output minimum limit is one way to prevent discomfort of chilled air that flows down the window. The limits can be over driven only by controlling the outputs directly via the Modbus (Modbus overdrive).

Input	DI1	U1	S/DI2	Output	Y1	Y2	A1	A2	Y3	Y4
					x	x	x	x	x	x

Note the following parameters:

Parameters	Modbus register	Description	factory setting	Min	Max	
Cmin%	40028	Minimum of cooling actuator	0.0	0.0	50.0	
Cmax%	40029	Maximum of cooling actuator	100.0	50.0	100.0	
Hmin%	40030	Minimum of heating actuator	0.0	0.0	50.0	
Hmax%	40031	Maximum of heating actuator	100.0	50.0	100.0	
Fmin%	40032	Minimum fan output	0.0	0.0	50.0	
Fmax%	40033	Maximum fan output	100.0	50.0	100.0	
Vmin%	40034	Minimum of VAV output	0.0	0.0	50.0	
Vmax%	40035	Maximum of VAV output	100.0	50.0	100.0	

OUTPUT OVERDRIVES

All outputs can be over driven separately by the Modbus.

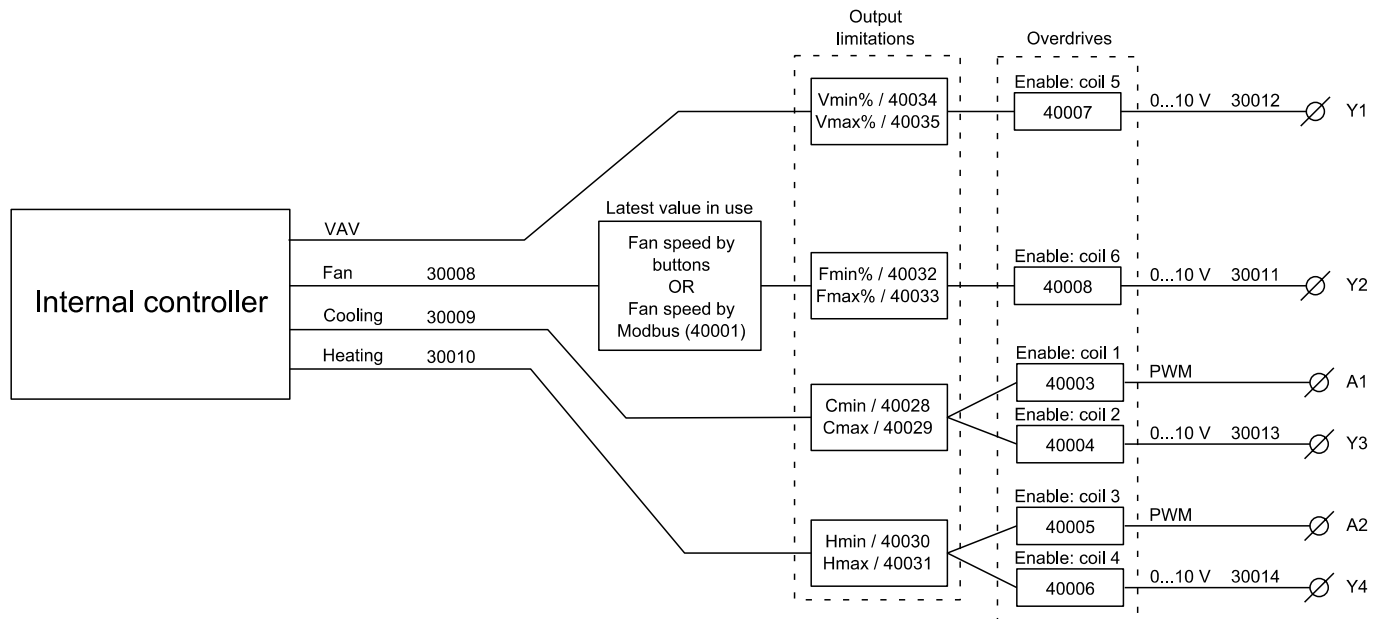

Coils

Register	Parameter description	Data Type	Value	Range	Default
1	Cooling PWM overdrive enable (A1)	Bit	Off=0, On=1	Off - On	0
2	Cooling 0-10V overdrive enable (Y3)	Bit	Off=0, On=1	Off - On	0
3	Heating PWM overdrive enable (A2)	Bit	Off=0, On=1	Off - On	0
4	Heating 0-10V overdrive enable (Y4)	Bit	Off=0, On=1	Off - On	0
5	VAV overdrive enable (Y1)	Bit	Off=0, On=1	Off - On	0
6	FAN overdrive enable (Y2)	Bit	Off=0, On=1	Off - On	0

Input registers

Register	Parameter description	Data Type	Value	Range	Default
30008	Current Cooling (controller)	Signed 16	0...1000	0 ...10.00 V	
30009	Current Heating (controller)	Signed 16	0...1000	0 ...10.00 V	
30010	Current FAN Speed (controller)	Signed 16	0...4	0 - 1 - 2 - 3 - 4	
30011	FAN speed (connector)	Signed 16	0...1000	0 ...10.00 V	
30012	VAV control (connector)	Signed 16	0...1000	0 ...10.00 V	
30013	Cooling control (connector)	Signed 16	0...1000	0 ...10.00 V	
30014	Heating control (connector)	Signed 16	0...1000	0 ...10.00 V	

Holding registers

Register	Parameter description	Data Type	Value	Range	Default
40001	FAN speed by Modbus	Signed 16	0...4	0 - 1 - 2 - 3 - 4	0
40003	Overdrive Cooling PWM by Modbus (A1)	Signed 16	0 ... 1000	0,00 ... 100,0 %	0
40004	Overdrive Cooling 0...10 V by Modbus (Y3)	Signed 16	0...1000	0 ...10.00 V	0
40005	Overdrive Heating PWM by Modbus (A2)	Signed 16	0 ... 1000	0,00 ... 100,0 %	0
40006	Overdrive Heating 0...10 V by Modbus (Y4)	Signed 16	0...1000	0 ...10.00 V	0
40007	Overdrive VAV by Modbus (Y1)	Signed 16	0...1000	0 ...10.00 V	0
40008	Overdrive FAN by Modbus (Y2)	Signed 16	0...1000	0 ...10.00 V	0
40028	Minimum of cooling actuator	Signed 16	0 ... 500	0,0 ... 50,0 %	0
40029	Maximum of cooling actuator	Signed 16	500 ... 1000	50,0 ... 100,0 %	1000
40030	Minimum of heating actuator	Signed 16	0 ... 500	0,0 ... 50,0 %	0
40031	Maximum of heating actuator	Signed 16	500 ... 1000	50,0 ... 100,0 %	1000
40032	Minimum of fan output	Signed 16	0 ... 500	0,0 ... 50,0 %	0
40033	Maximum of fan output	Signed 16	500 ... 1000	50,0 ... 100,0 %	1000
40034	Minimum of VAV output	Signed 16	0 ... 500	0,0 ... 50,0 %	0
40035	Maximum of VAV output	Signed 16	500 ... 1000	50,0 ... 100,0 %	1000

SERVICE ALARM

If the temperature does not reach the dead zone in 120 hours, the Modbus register SERVICE ALARM bit changes to "ON" position. The alarm is for information purposes only and does not affect to the controller functions. The alarm can be reset via the Modbus.

NETWORK DESCRIPTION

Up to 247 controllers can be connected to a single network segment. The following diagram illustrates a typical installation where the room controllers are connected on the floor level to a gateway server.

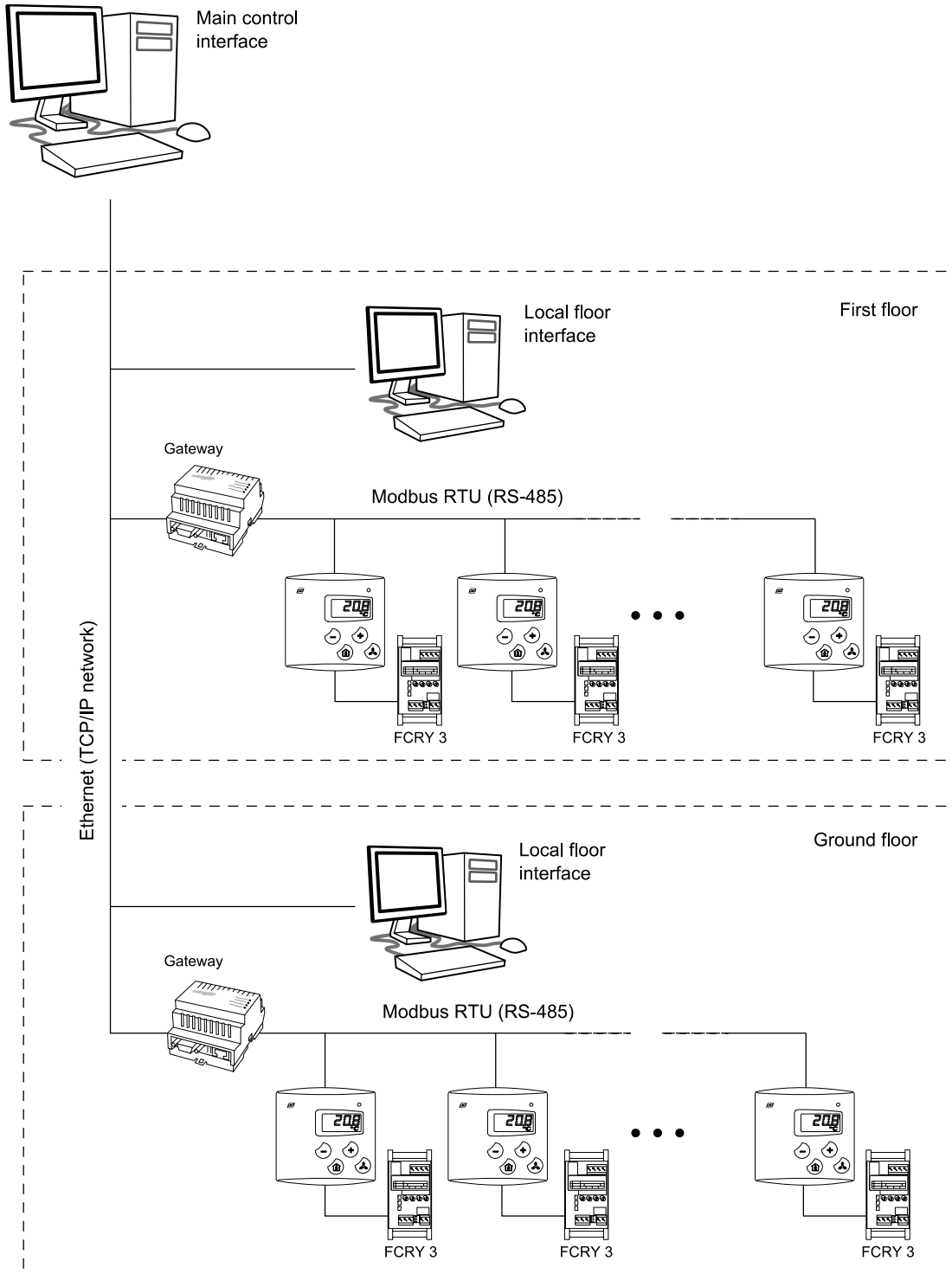

MODBUS REGISTERS AND FUNCTION CODES

The device supports the following Modbus registers and function codes. The parameter memory durability allows at least 1 million writing cycles.

Supported MODBUS functions:

0x01	Read Coils
0x02	Read Discrete Inputs
0x03	Read Holding Registers
0x04	Read Input Registers
0x05	Write Single Coil
0x06	Write Single Register
0x0F	Write Multiple Coils
0x10	Write Multiple Registers
0x17	Read/Write Multiple Registers

NOTE: If you try to write a parameter value that is beyond the parameter value range, the value will be replaced by the nearest acceptable value. For example, if you write 270 to the register 40011, the value will be replaced by 260.

Register	Parameter description	Data Type	Value	Range	Default
COILS					
1	Cooling PWM overdrive enable (A1)	Bit	Off=0, On=1	Off - On	0
2	Cooling 0-10V overdrive enable (Y3)	Bit	Off=0, On=1	Off - On	0
3	Heating PWM overdrive enable (A2)	Bit	Off=0, On=1	Off - On	0
4	Heating 0-10V overdrive enable (Y4)	Bit	Off=0, On=1	Off - On	0
5	VAV overdrive enable (Y1)	Bit	Off=0, On=1	Off - On	0
6	FAN overdrive enable (Y2)	Bit	Off=0, On=1	Off - On	0
7	On/Off damper overdrive enable (B1)	Bit	Off=0, On=1	Off - On	0
8	Light control overdrive enable (B2)	Bit	Off=0, On=1	Off - On	0
9	Overdrive On/off damper by Modbus (B1)	Bit	Off=0, On=1	Off - On	0
10	Overdrive Light control by Modbus (B2)	Bit	Off=0, On=1	Off - On	0
11	SERVICE ALARM RESET	Bit	Off=0, On=1	Off - On	0
12	Cooling disabled	Bit	Off=0, On=1	Off - On	0
13	Heating disabled	Bit	Off=0, On=1	Off - On	0
14	NIGHT MODE	Bit	Off=0, On=1	Off - On	0
15	Cooling output mode (0:DIR, 1:REV)	Bit	Off=0, On=1	Off - On	0
16	Heating output mode (0:DIR, 1:REV)	Bit	Off=0, On=1	Off - On	0
17	Number of cooling stages (0:1 stage, 1:2 stages)	Bit	Off=0, On=1	Off - On	0
18	Sequence of cooling stages (0:Valve first , 1:VAV first)	Bit	Off=0, On=1	Off - On	0
19	Fan stage simultaneously with valve stage	Bit	Off=0, On=1	Off - On	1
20	Night operation mode (0:Dead zone, 1:Frost guard)	Bit	Off=0, On=1	Off - On	0
21	Effective set point after night mode to day mode change (0:User, 1:Modbus)	Bit	Off=0, On=1	Off - On	0
22	Valve jam prevention	Bit	Off=0, On=1	Off - On	0
23	Fan type (0: 3-speed, 1:EC)	Bit	Off=0, On=1	Off - On	0
24	Fan speed 3 disabled	Bit	Off=0, On=1	Off - On	0
25	Effective fan speed after night mode to day mode change (0:User, 1:Modbus)	Bit	Off=0, On=1	Off - On	0
26	VAV for heating	Bit	Off=0, On=1	Off - On	0
27	Display (0:temperature, 1:Set point)	Bit	Off=0, On=1	Off - On	0
28	DI2 operation direction (0:NC, 1:NO)	Bit	Off=0, On=1	Off - On	1
29	Thermostat function, cooling (0: P/PI, 1:thermostat)	Bit	Off=0, On=1	Off - On	0
30	Thermostat function, heating (0: P/PI, 1:thermostat)	Bit	Off=0, On=1	Off - On	0

Register	Parameter description	Data Type	Value	Range	Default
31	Y1 for cooling (off = VAV)	Bit	Off=0, On=1	Off - On	0
32	Y2 for heating (off = FAN)	Bit	Off=0, On=1	Off - On	0
DISCRETE INPUTS					
10001	Occupied by PIR	Bit	Off=0, On=1	Off - On	
10002	Occupied by "man in a house"	Bit	Off=0, On=1	Off - On	
10003	DAY EXTENSION	Bit	Off=0, On=1	Off - On	
10004	DI1 Input state	Bit	Off=0, On=1	Off - On	
10005	DI2 Input state	Bit	Off=0, On=1	Off - On	
10006	CO ₂ overdrives	Bit	Off=0, On=1	Off - On	
INPUT REGISTERS					
30001	DISCRETE INPUTS (16 - 1)	Unsigned 16	16 bits	16 bits	
30002	COILS (16 - 1)	Unsigned 16	16 bits	16 bits	
30003	COILS (32 - 17)	Unsigned 16	16 bits	16 bits	
30004	Temperature	Signed 16	-600...600	-60.0...60.0 °C	
30005	External Temperature	Signed 16	-600...600	-60.0...60.0 °C	
30006	CO ₂	Signed 16	0...2000	0...2000 ppm	
30007	Effective Set point	Signed 16	50...500	5.0...50.0 °C	
30008	Current Cooling (controller)	Signed 16	0...1000	0 ...10.00 V	
30009	Current Heating (controller)	Signed 16	0...1000	0 ...10.00 V	
30010	Current FAN Speed (controller)	Signed 16	0...4	0 - 1 - 2 - 3 - 4	
30011	FAN speed (connector)	Signed 16	0...1000	0 ...10.00 V	
30012	VAV control (connector)	Signed 16	0...1000	0 ...10.00 V	
30013	Cooling control (connector)	Signed 16	0...1000	0 ...10.00 V	
30014	Heating control (connector)	Signed 16	0...1000	0 ...10.00 V	
30015	U1 Input" Value	Signed 16	0...1000	0 ...10.00 V	
30016	EXT NTC Value (connector)	Signed 16	-600...600	-60.0...60.0 °C	
30017	VAV/Boosting control (0:CO ₂ , 1:T, 2:PIR)	Signed 16	0 ... 2	0 - 1 - 2	
30018	Set point by user	Signed 16	±SP °C	±SP °C	
30019	Fan control by user	Signed 16	0 ... 4	0 - 1 - 2 - 3 - 4	
30020	User set point deviation	Signed 16	±SP	±SP	
HOLDING REGISTERS					
40001	FAN Speed by Modbus	Signed 16	0 ... 4	0 - 1 - 2 - 3 - 4	0
40002	Set point by Modbus	Signed 16	80 ... 500	8,0 ... 50,0 °C	210
40003	Overdrive Cooling PWM by Modbus (A1)	Signed 16	0 ... 1000	0,00 ... 100,0 %	0
40004	Overdrive Cooling 0...10 V by Modbus (Y3)	Signed 16	0...1000	0 ...10.00 V	0
40005	Overdrive Heating PWM by Modbus (A2)	Signed 16	0 ... 1000	0,00 ... 100,0 %	0
40006	Overdrive Heating 0...10 V by Modbus (Y4)	Signed 16	0...1000	0 ...10.00 V	0
40007	Overdrive VAV by Modbus (Y1)	Signed 16	0...1000	0 ...10.00 V	0
40008	Overdrive FAN by Modbus (Y2)	Signed 16	0...1000	0 ...10.00 V	0
40009	External temperature sensor / DI2 input (0:Not used, 1:ext T, 2:door/window, 3:condensation switch)	Signed 16	0 ... 3	0 - 1 - 2 - 3	0
40010	Temperature sensor adjustment	Signed 16	-30 ... 30	-3,0 ... 3,0 °C	0

Register	Parameter description	Data Type	Value	Range	Default
40011	Centre of user set point area	Signed 16	180 ... 260	18,0 ... 26,0 °C	210
40012	User set point area limits	Signed 16	0 ... 160	0,0 ... 16,0 °C	30
40013	Control mode	Signed 16	0 ... 1	P - PI	1
40014	Dead zone	Signed 16	0 ... 30	0,0 ... 3,0 °C	2
40015	Set point position in dead zone	Signed 16	0 ... 100	0 ... 100 %	50
40016	Proportional band	Signed 16	10 ... 320	1,0 ... 32,0 °C	10
40017	Integral time	Signed 16	50 ... 5000	50 ... 5000 s	300
40018	Fresh air control (0:CO ₂ /T, 1:DAY/T, 2: CO ₂ , 3:DAY)	Signed 16	0 ... 3	0 - 1 - 2 - 3	0
40019	Night mode dead zone	Signed 16	0 ... 100	0,0 ... 10,0 °C	60
40020	Frost guard thermostat set point	Signed 16	80 ... 500	8,0 ... 50,0 °C	170
40021	DI1 mode (0:not used, 1:day/night change by ext. contact)	Signed 16	0 ... 1	0 - 1	0
40022	DI1 operation direction (0:NC, 1:NO)	Signed 16	0 ... 1	0 - 1	0
40023	DI1 delay passive to active	Signed 16	0 ... 60	0 ... 60 min	0
40024	DI1 delay active to passive	Signed 16	0 ... 60	0 ... 60 min	5
40025	Duration of temporary day mode	Signed 16	1 ... 480	1 ... 480 min	120
40026	Minimum VAV output in day mode	Signed 16	0 ... 1000	0,0 ... 100,0 %	0
40027	U1 mode (0:not used, 1:CO ₂ , 2:T set point, 3:T meas)	Signed 16	0 ... 3	0 - 1 - 2 - 3	0
40028	Minimum of cooling actuator	Signed 16	0 ... 500	0,0 ... 50,0 %	0
40029	Maximum of cooling actuator	Signed 16	500 ... 1000	50,0 ... 100,0 %	1000
40030	Minimum of heating actuator	Signed 16	0 ... 500	0,0 ... 50,0 %	0
40031	Maximum of heating actuator	Signed 16	500 ... 1000	50,0 ... 100,0 %	1000
40032	Minimum of fan output	Signed 16	0 ... 500	0,0 ... 50,0 %	0
40033	Maximum of fan output	Signed 16	500 ... 1000	50,0 ... 100,0 %	1000
40034	Minimum of VAV output	Signed 16	0 ... 500	0,0 ... 50,0 %	0
40035	Maximum of VAV output	Signed 16	500 ... 1000	50,0 ... 100,0 %	1000
40036	Fan output scaling, high end	Signed 16	0 ... 1000	0,00 ... 100,0 %	1000
40037	Fan output scaling, low end	Signed 16	0 ... 1000	0,00 ... 100,0 %	0
40038	Fan usage (0:Off, 1:cooling, 2:heating, 3:cooling and heating)	Signed 16	0 ... 3	0 - 1 - 2 - 3	0
40039	Low limit P-band for CO ₂ control	Signed 16	400 ... 1000	400 ... 1000ppm	700
40040	High limit P-band for CO ₂ control	Signed 16	500 ... 2000	500 ... 2000ppm	1250