

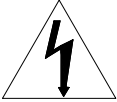

Installation and Operation Manual
for
Intelligence Dome Camera
V1.1

Please read the operation manual carefully
before installing and using this unit

SAFETY PRECAUTIONS

	CAUTION RISK OF ELECTRIC SHOCK .DO NOT OPEN!	
CAUTION: TO REDUCE THE RISK OF ELECTRICAL SHOCK DO NOT OPEN COVERS.NO USER SERVICEABLE PARTS INSIDE REFER SERVICING TO QUALIFIED SERVICE PERSONNEL		



The lightning flash with a arrowhead symbol , in an equilateral triangle , is intended to alert the user. There is uninsulated “dangerous voltage” presence near by the product’ s enclosure which may be risk of to persons .



The exclamation point within an equilateral triangle is intended to alert the user to reference of the important operating and maintenance (servicing) instructions .

THE PRODUCT CODE MARKED ON THE BOTTOM COVER .PLEASE FILL THE CODE IN THE FOLLOWING BLANK . PLEASE SAVING THIS SPECIFICATION CAREFULLY, SO THAT CHECKING.

MODEL : _____
PRODUCT CODE : _____

INDEX

1. <u>Important Safeguards</u> -----	1
2. <u>Description of Functions</u> -----	3
2.1 <u>Integrated Multi-Protocol Decoder</u> -----	3
2.2 <u>Integrated Speed-Variable PAN/TILT</u> -----	3
2.3 <u>High Intelligent Degree</u> -----	4
2.4 <u>Functions of the Camera</u> -----	5
3. <u>Setup of the Menu of the Dome Camera</u> -----	6
3.1 <u>Basic Operation of the Menu</u> -----	6
3.2 <u>Setup of the Menu</u> -----	6
3.3 <u>Appendix to the Menu</u> -----	10
4. <u>Setup of the Dome Camera</u> -----	12
4.1 <u>Connection of the System</u> -----	12
4.2 <u>Setup of Coding Switch of Dome Camera</u> -----	14
4.3 <u>Setup of the Protocol and the Default Baud Rate</u> -----	16
4.4 <u>Setup of the Baud Rate of Communication</u> -----	16
5. <u>The Installation of the System</u> -----	17
5.1 <u>Dimension of the Product</u> -----	17
5.2 <u>The Style of Installation</u> -----	17
5.3 <u>The step of high speed dome installs</u> -----	18
5.4 <u>The step of Middle/low speed dome installs</u> -----	21
6. <u>Technical data table</u> -----	25
7. <u>Troubleshooting</u> -----	28
<u>Appendix</u>	
I : <u>Lighting Proof and Surge Signal Proof</u> -----	29
II : <u>The Cleaning of Clear Down Cover</u> -----	30
III : <u>RS485 Bus Basic Knowledge</u> -----	31
IV : <u>Wire Diameter and Transmission Distance Comparison Chart</u> -----	34
V : <u>Wire Gauge Conversion Chart</u> -----	35

1. Points for Attention

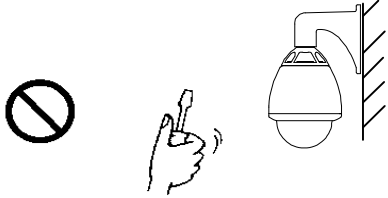
1. All the safety and operating instructions should be read before the units is operated.
2. This unit should be operated only from the type of power source indicated on the marking label. If you are not sure of the type of power supply you plan to use, consult your appliance dealer or local power company. For units intended to operate from battery power or other sources, refer to operating instructions.

3. During the course of transportation, storage and installation, the product should be avoided from incorrect operations such as heavy pressing, strong vibration etc., which can cause damage of product as there are sophisticated optical and electronic devices inside the machine.
4. Do not attempt to disassemble the camera. In order to prevent electric shock, do not remove screws or covers. There are no user-serviceable parts inside.
5. Always follow all electrical standards for safety when it is in operation. Adopt the particular power supply which is provided with the unit. RS-485 and video signal should keep enough distance with high voltage equipments and cables when they are in transmission. Precautions for anti-lightning and anti-surgings should be taken if necessary.

6. The product should be indoor installed and operated to avoid rain and moisture. Do not use it in wet places. If outdoor installation is needed, the closed protect cover should be used and it is absolutely prohibited to use it in open air independently.



7. Do not operate it in case temperature, humidity and power supply are beyond the limited stipulations.

8. Do not let the camera aim at the sun or the object with extreme light whatsoever it is switched on or not. Do not let the camera aim at or monitor bright and standstill object for a long time.

9. Do not use aggressive detergent to clean the main body of the camera. Wipe dirt with dry cloth. If needed, mild detergent can be used suitably.

10. Operate the intelligent speed dome camera with great care to avoid shock or vibration. If operate incorrectly, the Speed Dome could be damaged.



11. Do not place this unit on an unstable stand, tripod, bracket, or mount. The unit may fall, causing serious injury to a person and serious damage to the unit. Use only with a stand, tripod, bracket, or mount recommended by the manufacturer or sold with the product. Any mounting of the unit should follow the manufacturer's instructions and should use mounting accessory recommended by manufacturer.

12. If necessary, use a commercial lens cleaning paper to clear the lens windows. Gently wipe the lens window until clean.

2. Description of Functions

The intelligent dome camera is a hi-tech CCTV product which incorporates high-clarity color camera, panoramic speed-variable PAN/TILT, multifunctional decoder, universal character generator, CPU processor, memory chip into a whole. It can largely reduce connection and installation processes of components in the system, rise up reliability of the system and facilitate installation and maintenance. Therefore it has advantages of beautiful appearance, compact structure and easy operation.

1. Integrated Multi-Protocol Decoder









- a. With integrated decoder and multi-protocol, it can integrate 16 kinds of communication protocols in maximum. As its baud rate of communication can be adjusted, it is compatible with many normal systems by easy setup inside the dome camera, so it has stronger versatility.
- b. RS485 serial control: addresses of camera 1-1023.

2. Integrated Speed-Variable PAN/TILT

- a. Turning 360° horizontally and continuously with unlimited positions and an adjustable speed from 0.2 - 300°/s; Middle-speed 0 - 30° /s, low speed 0.2 ~ 15° /s , turning 0 - 90° vertically with a speed up to 120 °/s, Middle/low speed hand control speed: 0 ~ 15°/s.
- b. Running stably at low speed with super lower noise. Pictures have no shaking.
- c. High speed dome automatic 180° flip and panoramic monitoring without blind point, the location precision up to $\pm 0.1^\circ$, Middle/low speed the location precision up to $\pm 0.2^\circ$

3. High Intelligent Degree

- a. Dome general functions
 - a. As much as 128 preset positions can be preset with powerless memory
 - b. The camera can scan horizontally between two points and scan speed can be modified. The positions of linear scan are optional and the dome camera can scan the range larger or smaller than 180° between any two points with adjustable speed.
 - c. Six sets of programmable tour locus with 16 position each set. The running speed and the detention time are adjustable respectively;
 - d. The Integrated Multi-Protocol Multiple communication protocols are integrated inside the dome camera with selectable baud rate from 2400 bps to 19200 bps.
- b. High speed dome special functions
 - a. The dome camera can simulate the PTZ route operated by you in 40 seconds by the self-learning function of the locus with powerless memory;.
 - b. Character Overlapping. The humane structure of the menu makes all setups and programming of the dome camera more convenient and easy.
 - c. Proportional pan function. The speed dome will depend on the amount of zoom. At telephoto zoom settings, the pan and tilt speeds will be slower for a given amount of joystick deflection than at wide zoom settings. This keeps the image from moving too fast on the monitor when there is a large amount of zoom. This slowing does not happen when going to a preset, but does occur in turbo mode when high zoom is selected. The minimum pan and tilt speeds are 0.1 degree per second at full zoom.

- 4. Functions of the Camera (icons can be displayed on the screen when the option DISPLAY of the camera is ON, Only for 18x Camera)**
- a. Description of the Focus Control Mode: the user can adjust the focus of the camera manually. When the camera is on near focus, the icon  appears on the screen; when on the nearest state, the icon  appears while on the far focus, the icon  appears.
 - b. Description of Backlight Compensation: when the object to be shot is dark and looks dim, the user can open the backlight compensation according to actual need and the icon  appears on the screen.
 - c. Description of White Balance: when the image has color distort on the screen, the user can set different modes by orders. There are 6 modes for options: ① Indoor Mode  ② Outdoor Mode  ③ Touch Mode  ④ Automatic Trace of White Balance ATW ⑤ Manual WB-MAN ⑥ Automatic Mode.
 - d. Description of ZOOM Control: user can “pull near” or “push far” the lens according to actual conditions, and the symbol  appears on the screen in which the front part means optical multiplication while the rear part means digital multiplication.
 - e. Description of Electronic Shutter: it is fixed on 1/50 sec after initialization when the camera is switched on, and the digital 50 appears on the screen.
 - f. Setup of Image Effect: the camera works on OFF state under normal condition and no image effect symbol appears on the screen. When “B&W” appears on the screen, it means the camera is on black and white state.
 - g. AE Mode: setup of Manual/Automatic.
 - h. Minimum illumination: It is used only when the external brightness is extremely low. Normally the camera works on the automatic state. In case the external brightness is lower than 1Lux, the camera can be switch to the Zero illumination state automatically and icon  appears on the screen. You can also set the Zero illumination state manually.

3. Setup of the Menu of the Dome Camera

1. Basic Operation of the Menu

- 1.1 Call preset 64 or call preset 1 twice within 4 seconds to enter the main menu by the control keyboard or by the matrix.
- 1.2 When the menu is displayed on the screen, operate "TILT UP", "TILT DOWN" to move the cursor to the option to be set, operate "PAN LEFT", "PAN RIGHT" to modify the content or the order to enter this option.
- 1.3 Keep the joystick in one direction for over 1 second to speed up operation.
- 1.4 All setups on the menu couldn't be lost even power failure happens.
- 1.5 Special utilizations can be seen on the descriptions of functions of the menu in detail.

2. Setup of the Menu

2.1 MAIN MENU

2.1.1 DISPLAY SETUP: to enter the submenu of display of the screen by which ID display, title display of preset point and display of camera screen can be set.

2.1.2 CAMERA SETUP: to enter the submenu of setup of normal data of camera.

2.1.3 CONTROL SETUP: to enter the submenu of setup of control data over the dome camera.

2.1.4 CAMERA MASK SET: to enter the submenu of setup of mask function of camera.

2.1.5 PROGRAM: to enter the setup of enhanced function of dome camera.

2.1.6 PAL CAMERA: PAL/NTSC switching to suit the camera.

MAIN MENU
1.DISPLAY SETUP
2.CAMERA SETUP
3.CONTROL SETUP
4.CAMERA MASK SET
5.PROGRAM
6.PAL CAMERA
7.CAM DEFAULT SET
8.DOME RESET
9.EXIT

- 2.1.7 CAM DEFAULT SET: to reset default setup of camera.
- 2.1.8 DOME RESET: to reset the dome camera.
- 2.1.9 EXIT: to quit the main menu.

2.2 DISPLAY SETUP

2.2.1 ID DISPLAY: when it is set at ON, address of dome camera appears on the screen such as "CAM 001". The default setting is ON.

DISPLAY SETUP	
1.ID DISPLAY	ON
2.ID POS	TOP-L
3.TITLE DIS	ON
4.TITLE POS	01 LINE
5.CAM DISPLAY	ON
6.RETURN	

2.2.2 ID POS: to set the display position of address on one of following corners: TOP-L, TOP-R, BOTT-R and BOTT-L.

2.2.3 TITLE DIS: when it is set at ON, the title of preset point appears on the left of screen such as "NO.001 ABCDEFGH" when the preset point is called. The modification of title of preset point is set on PROGRAM option.

2.2.4 TITLE POS: to set the display position of title of preset point from Line 1 to Line 10. Line 1 is at the top of screen.

2.2.5 CAM DISPLAY: when it is set at ON, the camera screen will be opened.

RETURN: to return to MAIN MENU.

2.3 CAMERA SETUP

2.3.1 SLOW SHUTTER: frame accumulation with two options Manual/Automatic. When camera screen is opened under automatic state, ASS displays on screen.

CAMERA SETUP	
1.SLOWSHUTTER	AUTO
2.BACK LIGHT	OFF
3.ICR SHOT	AUTO
4.IRIS	AUTO
5.D-ZOOM	ON
6.FOCUS	AUTO
7.WB SET	ATW
8.MENU OF CAM	
9.RETURN	

2.3.2 BACK LIGHT: backlight compensation ON/OFF.

2.3.3 ICR SHOT: low shooting, ON/AUTO

2.3.4 IRIS: setup of automatic iris AUTO/MANU.

2.3.5 D-ZOOM: setup of digital zooming ON/OFF.

2.3.6 FOCUS: setup of automatic focusing AUTO/ MANU.

2.3.7 WB SET: setup of white balance. ATW / INDOOR / OUTDOOR / ONEPUSH / AUTO / MANU

2.3.8 MENU OF CAM: blank

2.3.9 RETURN: return to MAIN MENU

2.4 CONTROL SETUP

2.4.1 AUTO FLIP: 180° automatic flip of dome camera ON/OFF.

2.4.2 ALARM: ALARM ON/OFF switch

2.4.3 PRESET PIC: NOP

2.4.4 HOME OPTION: enter the submenu of automatic home function.

2.4.4.1 AUTO HOME: when it is set at ON, home function is available, namely, the dome camera will return HOME if user has no action in a period of time. The dome camera shall not return HOME if it is on tour state. If no HOME is needed when the dome camera is stopped, set the option at OFF.

2.4.4.2 HOME POS:HOME means return home. For example to set one scene as HOME, call the scene first and set it as preset point, then call out the menu to enter into this submenu, change figures after HOME POS into 5. If automatic HOME function is needed, do not forget to set AUTO HOME at ON. This option display 1—50/RESTORE/PATROL1; 1—50 means preset position from 1 to 50; RESTORE means return back to before state (manual control); PATROL1 means run the first patrol.

2.4.4.3 DWELL TIME:to set the time of automatic HOME, which means the camera shall return HOME if it is not controlled in a period of time which can be from 1 to 99 minutes.

2.4.4.4 RETURN: return to the menu one level higher.

2.4.5 RETURN: return to MAIN MENU.

CONTROL SETUP	
1.AUTO FLIP	ON
2.ALARM	ON
3.PRESET PIC	MOVE
4.HOME OPTION	
5.RETURN	

HOME OPTION	
1.AUTO HOME	ON
2.HOME POS	01
3.DWELL TIME	05 MIN
4.RETURN	

2.5 CAMERA MASK SET

- 2.5.1 MASK PRIVACY: ON/OFF
- 2.5.2 MASK SHADE: BLACK/GRAY/WHITE
- 2.5.3 MASK REGION: 6 or 2 privacy zone masking.(only for part of camera)
- 2.5.4 RETURN: return to Main Menu

CAMERA MASK SET	
1.MASK PRIVACY	OFF
2.MASK SHADE	BLACK
3.MASK REGION	01
4.RETURN	

2.6 PROGRAM Options

- 2.6.1 AUTO PAN START POS: To set start position of auto scan between two points. To move the dome camera by joystick after entering and to return by CLOSE button.
- 2.6.2 AUTO PAN END POS: To set end position of auto scan between two points. To move the holder by joystick after entering and to return by CLOSE button.
- 2.6.3 RUN AUTO PAN: Auto scan function between two points. First of all, you must set the start position and the end position of auto scan. If the start position is just the end position, it means 360° scan. The speed of auto scan has six grades: FAST / NORMAL / SLOW / -FAST / -NORMAL / -SLOW in which the first three grades are scan less than 180° while the later three grades larger than 180°. Adjust speed by PAN LEFT/PAN RIGHT, and operate and exit by OPEN button. The start position and the end position of auto scan are set by options 1 and 2 in this submenu.
- 2.6.4 SET TITLE: to edit titles of preset position. Only previous 63 preset points have their titles. Select no. of preset position by PAN LEFT/PAN RIGHT, enter into edit by OPEN button and exit

PROGRAM	
1.AUTO PAN START POS	
2.AUTO PAN END POS	
3.RUN AUTO PAN	SLOW
4.SET TITLE	01
5.SET PATROL	01
6.RUN PATROL	01
7.RECORD PATTERN	
8.RUN PATTERN	
9.RETURN	

edit by CLOSE button. Operations under edit state can be seen later.

- 2.6.5 SET PATROL: to edit data for multi-points patrol. Select no. of patrol by PAN LEFT/PAN RIGHT, enter into edit by OPEN button and exit edit by CLOSE button. Operations under edit state can be seen later.
- 2.6.6 RUN PATROL: to run multi-points patrol function. Select no. of patrol by PAN LEFT/PAN RIGHT, run and exit by OPEN button.
- 2.6.7 RECORD PATTERN: This pattern can consist of any standard pan and tilt or lens command. Preset, flip, digital zoom, proportional pan, and turbo are not allowed in a pattern. The pattern length is 40 seconds in maximum. To return when 40 seconds expire or by push CLOSE button.
- 2.6.8 RUN PATTERN: to self-learn loci of tour. To exit the menu after running or to stop running by joystick.
- 2.6.9 RETURN: return to Main Menu.

3. Appendix to the Menu

3.1 Operation of Edit State of Multi-Points Patrol.

When entering into edit state the screen displays as follows:

NO	POS	SP	TM	POS	SP	TM
01	001	01	01	002	01	01
03	003	01	01	004	01	01
05	---	---	---	---	---	---
07	---	---	---	---	---	---
09	---	---	---	---	---	---
11	---	---	---	---	---	---
13	---	---	---	---	---	---
15	---	---	---	---	---	---
SEQ:01		CLOSE:EXIT				

NO – Serial No. of patrol position

POS – No. of preset position

SP – leaving speed

TM – dwelling time

After entering into edit area, screen shows as follows:

Edit Area, data of 2 patrol position appears on one line.

SEQ:01– It means the set No.1 patrol

CLOSE: EXIT– Push CLOSE to exit edit state

Both top and bottom lines display prompt and information of each patrol is displayed on the middle of the screen. **Data of 2 Patrol points appears on one line.** Move cursor by PAN LEFT/RIGHT and modify data by TILT UP/DOWN. Press buttons for one second to speed up operation. Press CLOSE button to exit edit state and store modifications. The program will search the position of the first “---” of POS, store data before it and regard data after it as invalid. In above figure, the program stores previous four points with settable range from 1 to 63 and from 65 to 128. When “---” of POS appears, the tour range is ended. The settable range of SP is from 0 to 8 (0 and 1 are the same with fastest speed while 8 has the lowest speed). The settable range of TM is from 0 to 99 seconds.

3.2 Operation of Title of Preset Point in Edit State.

When entering into edit state the screen displays as follows: In the figure we find the preset point is No.1 with title of “NO TITLE”. Move cursor by PAN LEFT/RIGHT and modify data by TILT UP/DOWN. Press buttons for one second to speed up operation.

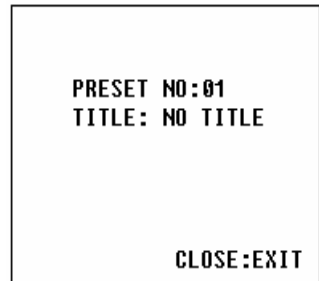

Press CLOSE button to exit edit state and store modifications. The title of preset point has 8 characters in maximum such as 0-9, A-Z, +, - and space. Note: the first character should be 0-9 or A-Z, otherwise it means to delete the title of the preset point, and when preset point is adjusted, only “NO.XXX” appears without title to be displayed.

4. Setup of the Dome Camera

1. Connection of the System

1) The Systematic Drawing of the Dome Camera

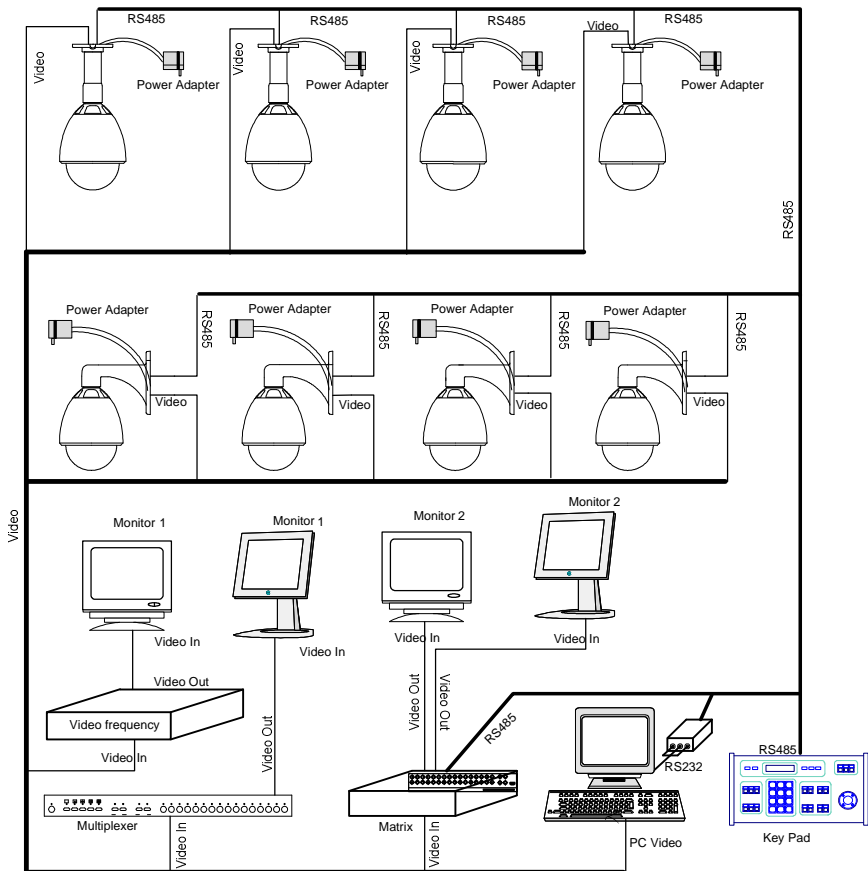

Figure 1

2) Address / Protocol Coding Switch Drawing

a. High speed dome

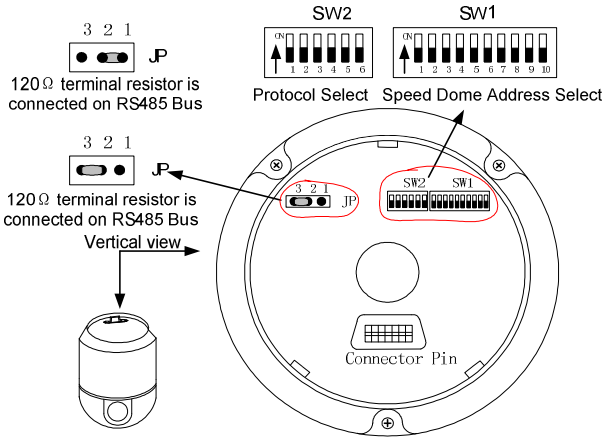

Figure 2

b. Middle speed and low speed dome

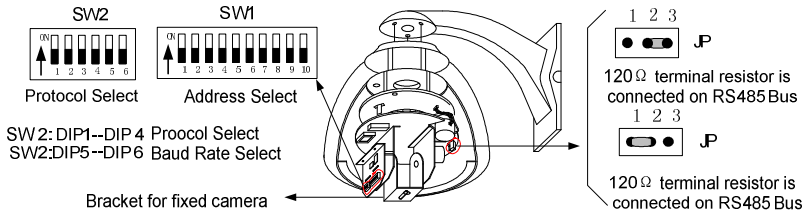

Figure 3

As shown in Figure 2,3, SW1 is used to set address of the dome camera from 1 – 1023. The coding switches from DIP-10 to DIP-1 are equivalent to a 10-bit binary digital. DIP-10 is MSB while DIP-1 is LSB. The state “ON” of each bit means 1 while “OFF” means 0. Following table shows states of coding switches of some addresses.

Dome Address	States of Coding Switches									
	DIP-1	DIP-2	DIP-3	DIP-4	DIP-5	DIP-6	DIP-7	DIP-8	DIP-9	DIP-10
1	ON	OFF	OFF	OFF	OFF	OFF	OFF	OFF	OFF	OFF
2	OFF	ON	OFF	OFF	OFF	OFF	OFF	OFF	OFF	OFF
3	ON	ON	OFF	OFF	OFF	OFF	OFF	OFF	OFF	OFF
4	OFF	OFF	ON	OFF	OFF	OFF	OFF	OFF	OFF	OFF

5	ON	OFF	ON	OFF	OFF	OFF	OFF	OFF	OFF	OFF
6	OFF	ON	ON	OFF	OFF	OFF	OFF		OFF	OFF
7	ON	ON	ON	OFF	OFF	OFF	OFF	OFF	OFF	OFF
8	OFF	OFF	OFF	ON	OFF	OFF	OFF	OFF	OFF	OFF
9	ON	OFF	OFF	ON	OFF	OFF	OFF	OFF	OFF	OFF
10	OFF	ON	OFF	ON	OFF	OFF	OFF	OFF	OFF	OFF
11	ON	ON	OFF	ON	OFF	OFF	OFF	OFF	OFF	OFF
12	OFF	OFF	ON	ON	OFF	OFF	OFF	OFF	OFF	OFF
13	ON	OFF	ON	ON	OFF	OFF	OFF	OFF	OFF	OFF
14	OFF	ON	ON	ON	OFF	OFF	OFF	OFF	OFF	OFF
15	ON	ON	ON	ON	OFF	OFF	OFF	OFF	OFF	OFF
16	OFF	OFF	OFF	OFF	ON	OFF	OFF	OFF	OFF	OFF
17	ON	OFF	OFF	OFF	ON	OFF	OFF	OFF	OFF	OFF
18	OFF	ON	OFF	OFF	ON	OFF	OFF	OFF	OFF	OFF
...
1023	ON	ON	ON	ON	ON	ON	ON	ON	ON	ON

Table 1

For Example:

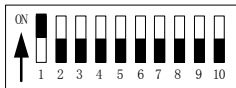

Speed Dome Address=1

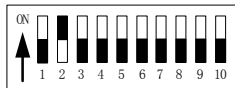

Speed Dome Address=2

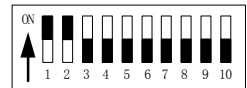

Speed Dome Address=3

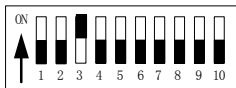

Speed Dome Address=4

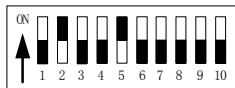

Speed Dome Address=18

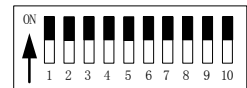

Speed Dome Address=1023

2. **Setup of the Protocol and the Default Baud Rate.** As shown in Figure 2, SW2 is used to set the protocol of communication and the baud rate used by the dome camera. DIP-4 to DIP-1 of SW2 is used to select protocols and 16 different protocols can be selected in maximum. Following table shows states of coding switches of protocols selected by the dome camera.

Protocols	DIP status				Normal Baud Rate	
	DIP-1	DIP-2	DIP-3	DIP-4	DIP-5	DIP-6
SAMSUNG	ON	OFF	OFF	OFF	OFF	ON
B01	ON	OFF	OFF	OFF	OFF	ON
NEON	ON	OFF	OFF	OFF	OFF	ON
Santachi	OFF	ON	OFF	OFF	OFF	ON
PELCO-D	ON	ON	OFF	OFF	OFF	OFF
PELCO-P/4800	OFF	OFF	ON	OFF	ON	OFF
PELCO-P/9600					OFF	ON
PANASONIC	ON	OFF	ON	OFF	OFF	ON
Longcomity	OFF	ON	ON	OFF	OFF	ON
HUNDA600	ON	ON	ON	OFF	OFF	ON
LILIN	OFF	OFF	OFF	ON	OFF	ON
VICON	ON	OFF	OFF	ON	ON	OFF
MOLYNX	OFF	ON	OFF	ON	OFF	ON
KALATEL	ON	ON	OFF	ON	ON	OFF
VCL	OFF	OFF	ON	ON	OFF	ON
Reserved	ON	OFF	ON	ON	OFF	ON
ALEC	OFF	ON	ON	ON	OFF	ON
Ultrak	ON	ON	ON	ON	OFF	ON

Table 2

Some protocols and the states of the coding switches of normal baud rate of these protocols are shown as follows:

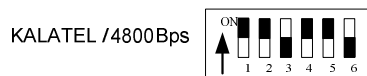
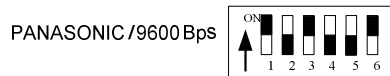
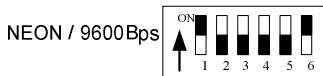

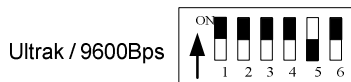

3. Setup of the Baud Rate of Communication. As shown in Figure 2,3 SW2 is used to set the protocol of communication and the baud rate used by the dome camera. DIP-6 and DIP-5 of SW2 are used to select the baud rate of communication and 4 different baud rates can be selected in maximum. If the controller adopts non-standard baud rate, you can adjust it to be identical with that of the main machine as per the following table.

Baud Rate of Communication	Setup of Baud Rate					
	DIP-1	DIP-2	DIP-3	DIP-4	DIP-5	DIP-6
2400 bps					OFF	OFF
4800 bps					ON	OFF
9600 bps					OFF	ON
19200 bps					ON	ON

Table 3

4. Selection of the Terminal Resistor of the Dome Camera..As shown in Figure 2、 3, JP1 is the select switch of the 120 Ω terminal resistor on the bus RS485, on which only one terminal resistor of the dome camera at the farthest end can be connected, while the terminal resistors of other devices should be opened.

5. The Installation of the System

1. Dimension of the Product

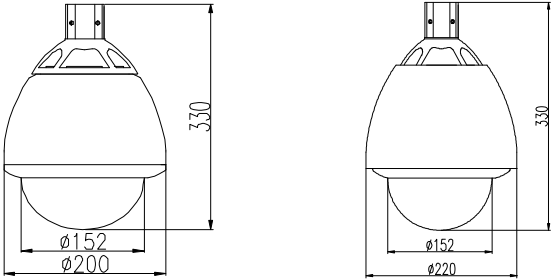

Figure 4

2. The Style of Installation

a) Wall Installation

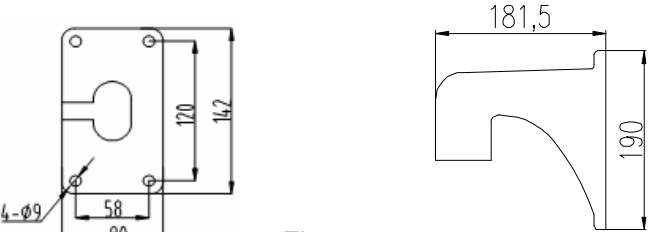

Figure5

b) In-Ceiling Installation

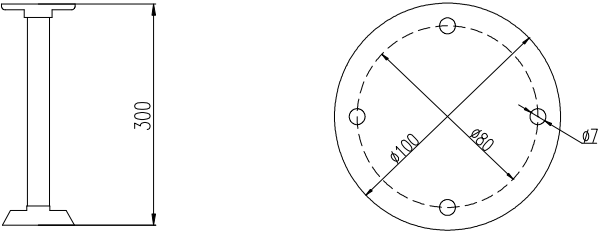

Figure6

c) Product disposition overall size

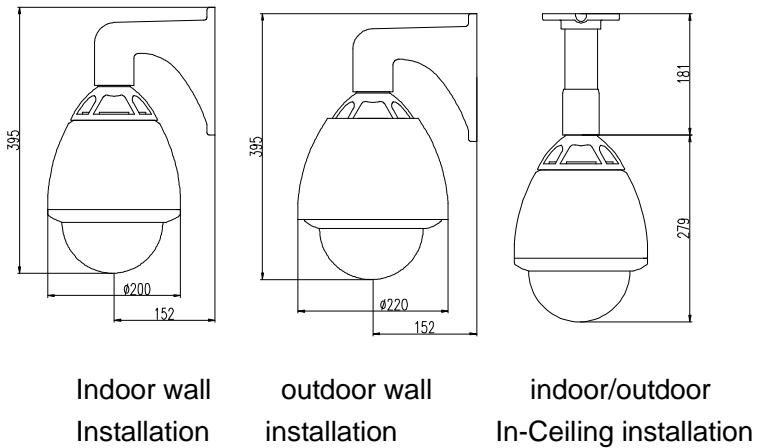

Figure 7

3. The step of high speed dome installs (taking wall-installing style as example)

- 1) Unpacking the carton and carefully take out the dome camera and its attachments.
- 2) Take out system control wires from the bracket (see Figure 8).
- 3) Fix the bracket on the wall with the M6 (see Figure 9).

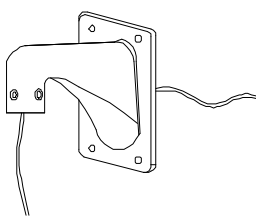

Figure8

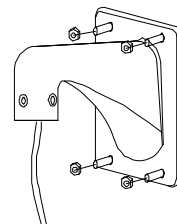

Figure9

- 4) Screw off the 4 tight screws which coats the ball twists with the M4 in six feet screwdriver(see Figure 10)

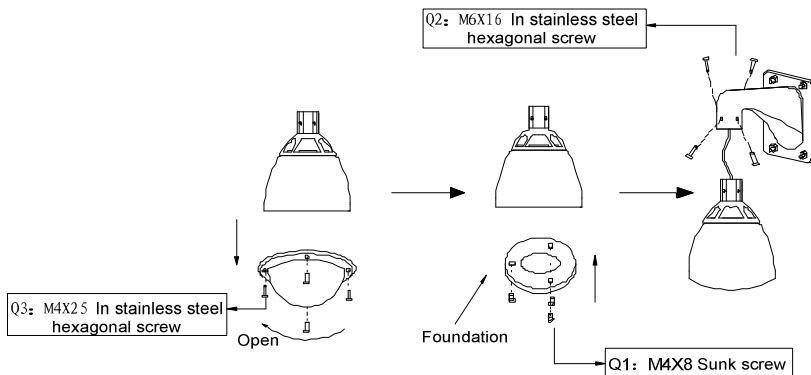

Figure 10

Figure 11

Figure 12

- 5) Fix the pedestal in the aluminum alloy ball (Figure 11). Install the ball on the bracket (Figure 12).
- 6) Trip wire to give alarm marking (Figure 13), System pilot wire marking(Figure 14)

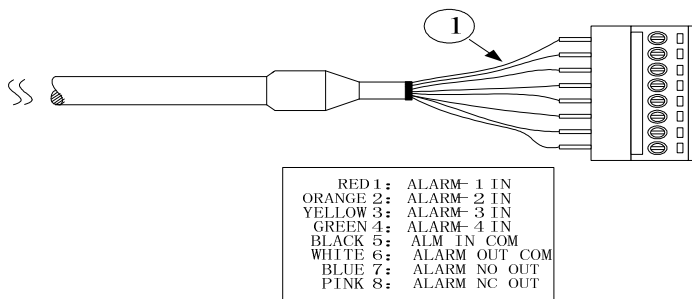

Figure 13

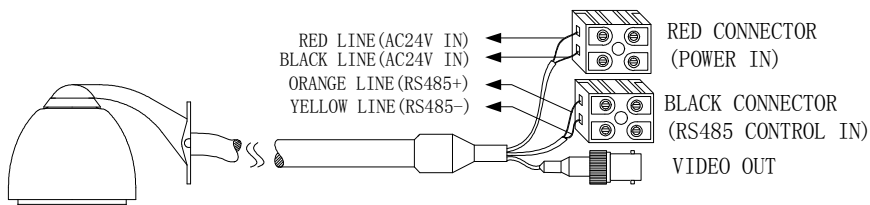

Figure 14

- 7) Insert attachment plug in aluminum alloy into socket D2 (Figure 15) . According the fig of D3 to connection. As show of fig47 when dome identify the alarm signal, that will set according the program immediately, then startup camera, switching the image of alarm field to main monitor. Surveillance the alarm preset, then record it in time. Fig16 is connection of alarm control
- 8) **⚠️ Input of alarm: Input signal of switch type, any other input signal will damage dome. When multi-channel with alarm signal, dome will respond one by one, the removed time is two sec.**
- ⚠️ Once the dome have alarm input, dome will not respond “scanning”、 “patrol”、 “remember tracking” etc function.**

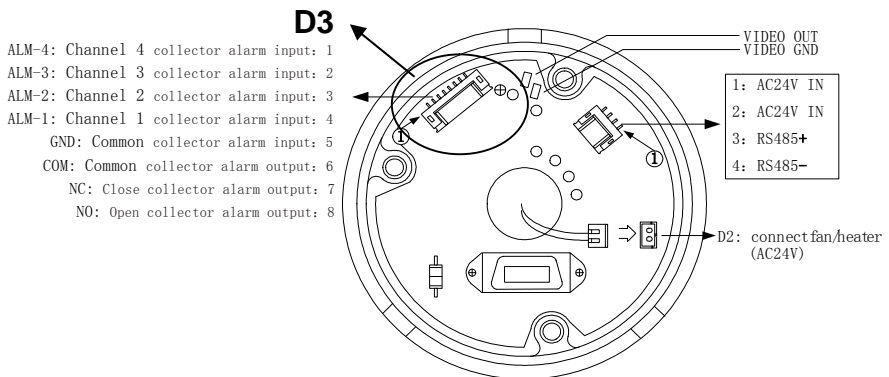

Figure 15

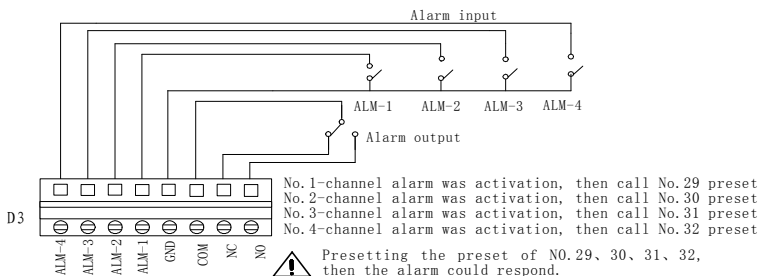

Figure 16

- 9) Based on the coding switches shown as Figure 2, set up the protocol used by the camera and the baud rate as per the state according to Table 2. Check the address of the camera to see if it is matched with that you need. If not, set the address of the dome camera at corresponding position as per Table 1.
- 10) **Rotate the vitreous cover on dome counterclockwise and take it out. Note: if Fixed the Speed Dome Camera in the aluminum alloy ball, you must take out the vitreous cover on dome. Otherwise, it will effect picture quality.** (see Figure 17)
- 11) Aiming the “MARK” on the ball at the notch on the pedestal, push the ball upward to the end and rotate clockwise until it is clicked, then mount the vitreous cover by rotating it clockwise (as shown on Figure 18), and mount the cover plate of the bracket at last (see Figure 19).

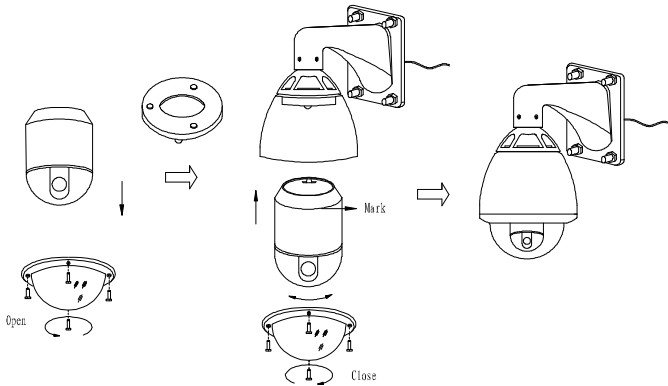

Figure17

Figure18

Figure19

4. **The step of Middle/low speed dome installs** (taking wall-installing style as example)

- 1) Unpacking the carton and carefully take out the dome camera and its attachments.
- 2) Rotate the vitreous cover counterclockwise and take it out. (Figure 20)

The attention if the ball machine agreement and the address do not use the adjustment, Then may cancel 2), 3), 4), 5), 6),

- 7) a step of operation.
- 3) 4 bolts black coats which the inside lining squeeze out, take down the inside lining black cover(Figure 21)
 - 4) Based on the coding switches shown as Figure 2, set up the protocol used by the camera and the baud rate as per the state according to Table 2. Check the address of the camera to see if it is matched with that you need. If not, set the address of the dome camera at corresponding position as per Table 1

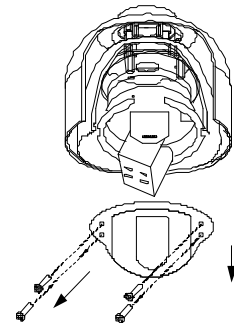
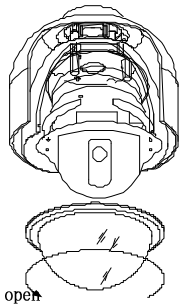

Takes down the inside lining black cover

Figure 20

Figure 21

- 5) Installs the inside lining black cover(Figure 22)
- 6) Installs the transparent vitreous cover (Figure 23)

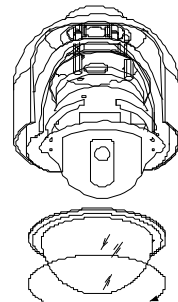
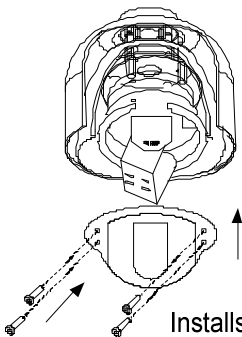

Installs the inside lining black cover

Close

Figure 22

Figure 23

- 7) Take out the cover of the wall-installed bracket(Figure 24)
- 8) Take out system control wires from the bracket(Figure 25)

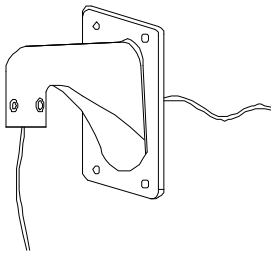

Figure 24

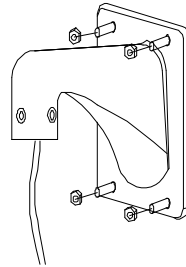

Figure 25

- 9) Fixes the support on the wall (Figure 26)
- 10) Fixes the dome to the support above

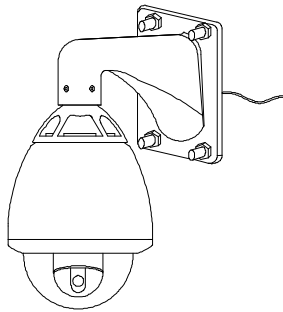

Figure 26

- 11) System pilot wire after (Figure 27) marking meets, after the electricity then controlled the ball machine for the system on.

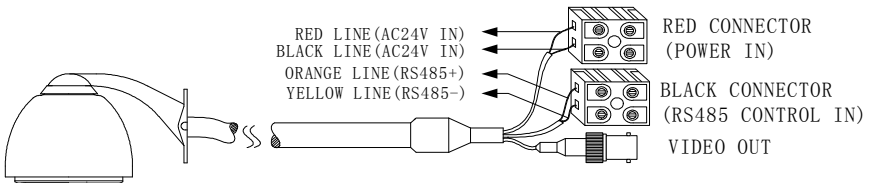

Figure 27

5. The step of outside dome installs:

- 1) Unpacking the carton and carefully take out the dome camera and its attachments.
- 2) takes out the support, fixes the support in the wall goes against

(Figure 28)

- 3) Take out system control wires from the bracket(Figure 29)
- 4) Fixes the ball cover to the support above(Figure 30)
- 5) System pilot wire after (Figure 15) marking meets, after the electricity then controlled the ball machine for the system on.

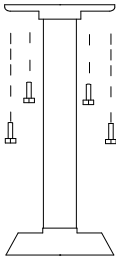

Figure 28

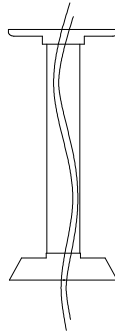

Figure 29

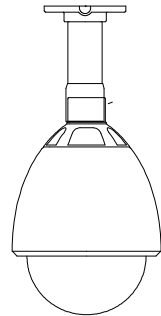

Figure 30

6. To Ensure a Smooth and Successful Installation, You Should:

- 1) Have electrical work to comply with latest national electrical code, national fire code, and all applicable local codes and ordinances.
- 2) Coordinate with other trades to avoid interference.
- 3) Verify existing conditions on the site and coordinate with owner side to ensure necessary utilities available.
- 4) Copy all related plans, specifications, shop drawings and attachments to schedule and coordinate related work.
- 5) Thoroughly review the project to ensure that all jobs should meet or exceed the above requirements. Contact with the CCTV Project Coordinator to draw attention in case alleged discrepancies occur.

6. Technical data table

1. High speed balls cameras technology

Power supply	AC24V 50/60Hz
Power consumption	Indoor dome: 15W Outdoor dome: 35W
Sync system	Internal/External selectable
Preset	128 presets
Auto tour	6
Pattern	40s
Alarm	4 channels input & 1 channel output
Privacy masking	6 (some model only)
Zoom-rotation Interaction	Control speed auto adjust according to the focus length
Auto flip	Rotate 180 when camera tilts to the vertical position
Auto pan scan	360°Programmable
Pan speed	0° -- 300°/s
Pan rotation range	360°continues
Title range	Tilt 90°
Tilt speed	0° -- 120°/s
Control mode	RS485
Baud Rate	2400/4800/9600/19200 bps
Fan & heater	Fan & heater auto-start (only outdoor dome)
Environment temp	Indoor dome: 0°C — +40°C Outdoor dome: -35°C -- +55°C

Table 4

2. Middle/low speed dome cameras technology

Power supply	AC24V 50/60Hz 1.70A
Power consumption	35W (including of the fan and heater)

Synchronization	Internal
Preset position	64
Cruising track	6
Pan scanning	360°programmably
Pan speed	Maximum 80°/s
Pan range	360°continuously
Tilt range	0-- 90°
Tilt speed	Maximum 12°/s
Communication	RS485
Baud rate	2400/4800/9600/19200 bps
Relative humidity	10-75% (without agglomeration)
Work temperature	Indoor: 0°C — +40°C Outdoor: -35°C -- +55°C

Table 5

3. Camera Optional data table

Mode		16x	18x	22x	23x	27x
		Color	Day/Night switch	Color	Day/Night switch	Day/Night switch
Sync mode		Internal	Internal/External			
Image Inductor		1/4"Color CCD				
Scanning system		2:1 interlacing				
Resolution		>470TVL	≥480TVL			
Effective Pixels	PAN	470,000 pixels	752×582(440K)		758×592(450K)	795×596(470K)
	NTSC	440,000 pixels	768×494(380K)		758×504(380K)	811×508(410K)
Sensitivity		1Lux(F1.6)	1Lux / 0.01Lux	0.2LuxF1.6 1/3s)	1Lux / 0.01Lux	1Lux / 0.01Lux

Iris	Auto/ Manual				
Focus	Auto/ Manual				
Zoom Rate	16x optical	18x optical	22x optical	23x optical	27x optical
	f=3.9 to 63 mm	f=4.1 to 73.8 mm	f=4 to 88 mm	f=3.6 to 82.8 mm	f=3.6 to 98 mm
Angel of view	Wide: 47°	Wide: 48°	Wide: 47°	Wide: 54°	
	TELE: 3°	TELE:2.7°	TELE:2.2°	TELE:2.5°	
B.L compensation	Auto/ Manual				
White balance	Auto/ Manual				
Gain Control	Auto/ Manual				
S/N	>46dB	≥50dB			
Video output	1.0±0.2Vp-p				

Table 6

4. Middle/low speed dome Special function control.Some special protocol such as “Santachi”, “PELCO-D” and “PELCO-P” without the command of control some especial functions, in order to use the special functions of dome, so we changed the command of calling/setting NO.51 preset to NO.64 preset to control them.

N	Object of control	Keyboard control	
		Call the N position	Preset the N position
51	Auto scan	Auto scan (low speed)	Auto cruise
52		Auto scan (middle speed)	Set the start point of scan
53		Auto scan (high speed)	Set the end point of scan
54	Camera power	Power on	Power off
55	Backlight *	On	Off
56	ICR shor	On	Off
57	OSD (Some cameras	On	Off

	have it's own menu, to open/close the menu by the command "turn on the OSD", and use the command "turn off the OSD" to open/close the OSD)		
58	Digital Zoom	On	Off
59	FOCUS	Auto	Manual
60	IRIS	Auto	Manual
61	White Balance Mode	Auto	Manual
62		Indoor	Outdoor
63		ATW	One Push WB
64		Frame pile function switch able	

Table 7

7. Troubleshooting

Problems	Possible Causes	Remedies
No action when power is switched on	Power supply fault	Replace
	Bad connection of the power	Correct
	Transformer damaged	Replace
Abnormal self-check. Images with motor noise	Mechanical failure	Repair
	Camera inclined	Reinstall
	Power supply not enough	Replace
Normal self-check but no images	Video signal fault	Reinstall
	Bad connection of the video	Press to connect well
	Camera damaged	Replace
Normal self-check but out of control	RS485 bus bad connection	Check the RS485 connection
	Dome ID setup is wrong	Reselect

	Protocol setup is wrong	Reset and Switch ON again
Vague image	Bad connection of the video	Press to connect well
	Power supply not enough	Replace
Dome camera out of control	Self check error	Switch ON again
	Bad connection of control	Press to connect well
	Bad control of matrix	Switch ON again

Table 8

Appendix I : Lightning Proof and Surge Signal Proof

The product adopts TVS lightning proof technology to prevent from damage by lightning strike below 1500 W and impulse signals such as surge; but it is also necessary to abide by the following precautions to ensure electrical safety based on practical circumstances:

- Keep the communication cables at least 50 meters away from high voltage equipment or cables.
- Make outdoor cable laying-out under eaves as possible as you can.
- In open area shield cables in steel tube and conduct a single point ground to the tube. Trolley wire is forbidden in such circumstances.
- In strong thunderstorm or high faradic zone (such as high voltage transformer substation), extra strong lightning proof equipment must be installed.
- Take the building lightning proof requirements into account to design the lightning proof and grounding of outdoor equipment and cable laying-out in accordance with the national and industrial standards.
- The system must be grounded with equal potentials. The earth ground connection must satisfy the anti-interference and electrical safety requirements and must not short circuited with high voltage

electricity net. When the system is grounded separately, the resistance of down conductor should be $\leq 4 \Omega$ and the sectional area of down conductor should be $\leq 25 \text{ mm}^2$ (refer to Picture 59)

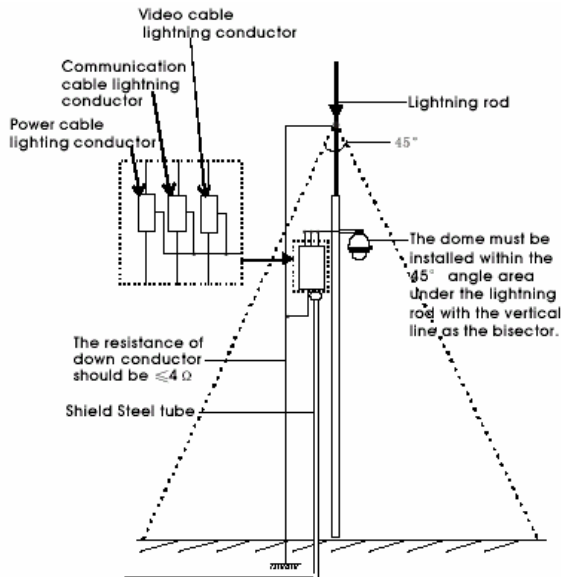

Figure 31

Appendix II : The Cleaning of Clear Down Cover

To obtain constant clear videos, user should clean the down cover periodically.

- Be cautious when cleaning. Hold the down cover ring only to avoid direct touch to the acrylic down cover. The acid sweat mark of fingerprint will corrode the coating of down cover and scratch on down cover will cause vague images.
- Use soft dry cloth or the substitute to clean the inner and outer surfaces.
- For hard contamination, use neutral detergent. Any cleanser for high grade furniture is applicable.

Appendix III: RS485 Bus Basic Knowledge

1. Characteristics of RS485 Bus

As specified by RS485 standards, RS485 Bus is of half-duplexed data transmission cables with characteristic impedance as $120\ \Omega$. The maximum load capacity is 32 unit loads (including main controller and controlled equipment).

2. Transmission distances of RS485 Bus

When user selects the 0.56mm (24AWG) twisted pair wires as data transmission cable, the maximum theoretical transmitting distances are as follows:

Baud Rate	Maximum Transmitting Distance
2400 Bps	1800m
4800 Bps	1200m
9600Bps	800m

Table 7

If user selects thinner cables, or installs the dome in an environment with strong electromagnetic interference, or connects lots of equipment to the RS485 Bus, the maximum transmitting distance will be decreased. To increase the maximum transmitting distance, do the contrary.

3. Connection and termination resistor

The RS485 standards require a daisy-chain connection between the equipment. There must be termination resistors with $120\ \Omega$ impedance at both ends of the connection (refer to Picture 32). Please refer to Picture 33 for simple connection. "D" should not exceed 7m.

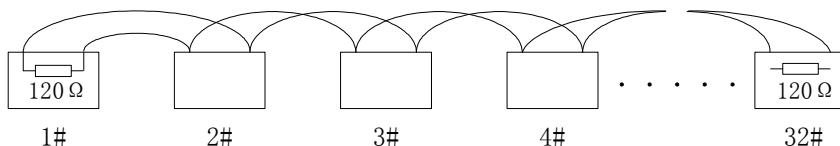

Figure 32

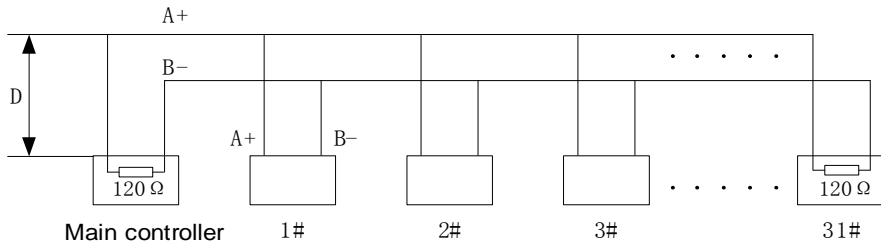

Figure 33

The connection of $120\ \Omega$ termination resistor: The termination resistor is ready on the Protocol PCB. There are two kinds of connection. Refer to the Protocol PCB jumper setting form (refer to Picture 2,3).

- 1) In the Picture it is the factory default connection. The jumper is seated on Pin2&Pin3 and the termination resistor is not connected.
- 2) when connecting the $120\ \Omega$ termination resistor, user should plug the jumper on Pin1&Pin2. and the termination resistor is connected.

4. Problems in practical connection

In some circumstances user adopts a star configuration in practical connection. The termination resistors must be connected to the two equipment that are farthest away from each other, such as equipment 1# and 15# in Picture 34. As the star configuration is not in conformity with the requirements of RS485 standards, problems such as signal reflections, lower anti-interference performance arise when the cables are long in the connection. The reliability of control signals is decreased with the phenomena that the dome does not respond to or just responds at intervals to the controller, or does continuous operation without stop (refer to Picture 34).

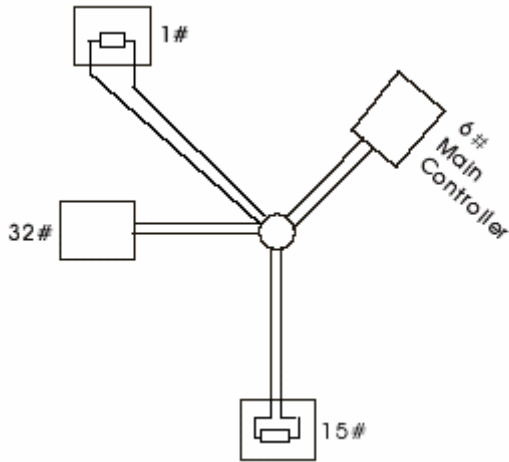

Figure 34

In such circumstances the factory recommends the usage of DR-HB16 RS485 distributor. The distributor can change the star configuration connection to the mode of connection stipulated in the RS485 standards. The new connection achieves reliable data transmission (refer to Picture 35).

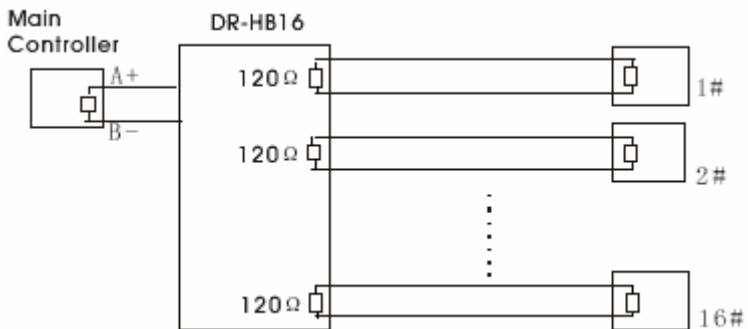

Figure 35

Appendix IV:

Wire Diameter and Transmission Distance Comparison Chart

Transmission Distance feet(m) Power [VA]	Wire diameter (mm)			
	0.8000	1.000	1.250	2.000
10	283 (86)	451 (137)	716 (218)	1811 (551)
20	141 (42)	225 (68)	358 (109)	905 (275)
30	94 (28)	150 (45)	238 (72)	603 (183)
40	70 (21)	112 (34)	179 (54)	452 (137)
50	56 (17)	90 (27)	143 (43)	362 (110)
60	47 (14)	75 (22)	119 (36)	301 (91)
70	40 (12)	64 (19)	102 (31)	258 (78)
80	35 (10)	56 (17)	89 (27)	226 (68)
90	31 (9)	50 (15)	79 (24)	201 (61)
100	28 (8)	45 (13)	71 (21)	181 (55)
110	25 (7)	41 (12)	65 (19)	164 (49)
120	23 (7)	37 (11)	59 (17)	150 (45)
130	21 (6)	34 (10)	55 (16)	139 (42)
140	20 (6)	32 (9)	51 (15)	129 (39)
150	18 (5)	30 (9)	47 (14)	120 (36)
160	17 (5)	28 (8)	44 (13)	113 (34)
170	16 (4)	26 (7)	42 (12)	106 (32)
180	15 (4)	25 (7)	39 (11)	100 (30)
190	14 (4)	23 (7)	37 (11)	95 (28)
200	14 (4)	22 (6)	35 (10)	90 (27)

Table 8

Appendix V : Wire Gauge Conversion Chart

Bare wire diameter metric size (mm)	AWG (Approximate)	SWG (Approximate)	Bare wire cross sectional area (mm ²)
0.050	43	47	0.00196
0.060	42	46	0.00283
0.070	41	45	0.00385
0.080	40	44	0.00503
0.090	39	43	0.00636
0.100	38	42	0.00785
0.110	37	41	0.00950
0.130	36	39	0.01327
0.140	35		0.01539
0.160	34	37	0.02011
0.180	33		0.02545
0.200	32	35	0.03142
0.230	31		0.04115
0.250	30	33	0.04909
0.290	29	31	0.06605
0.330	28	30	0.08553
0.350	27	29	0.09621
0.400	26	28	0.1237
0.450	25		0.1602
0.560	24	24	0.2463
0.600	23	23	0.2827
0.710	22	22	0.3958
0.750	21		0.4417
0.800	20	21	0.5027

0.900	19	20	0.6362
1.000	18	19	0.7854
1.250	16	18	1.2266
1.500	15		1.7665
2.000	12	14	3.1420
2.500			4.9080
3.000			7.0683

Table 9

CCTV SYSTEM