

PYLE® GEAR

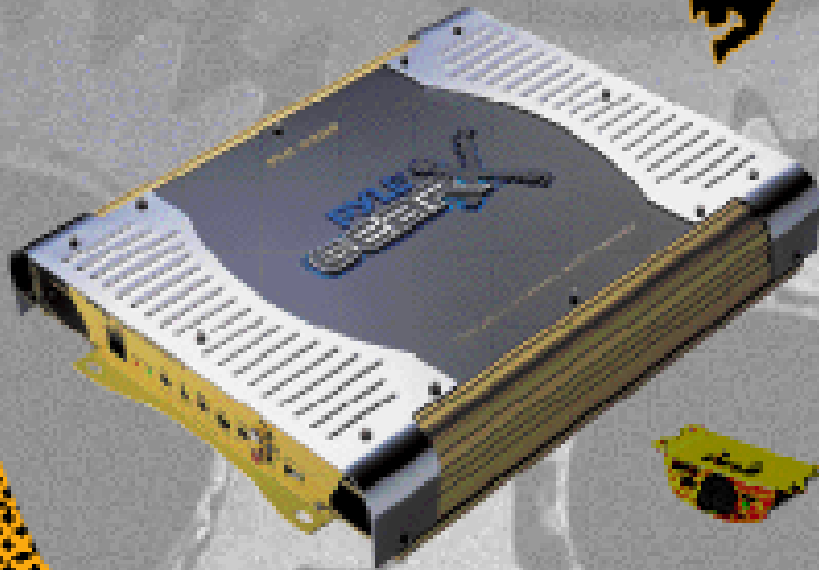

PLA-219 PLA-2150
PLA-2250 PLA-2350
PLA-2450 PLA-2550
PLA-2650 PLA-2750
PLA-2850

Two Channel High
Performance Power Amplifier

PLA-419 PLA-4150
PLA-4250 PLA-4350

Four Channel High
Performance Power Amplifier

PLA-4300D
Class-D Mono Block Power Amplifier

USER'S MANUAL



congratulations...

on your purchase of a Pyle Gear X Series amplifier. This amplifier extends the Pyramid tradition into a totally new series of amps, designed from the ground up to deliver the power, performance and flexibility the modern car audio enthusiast demands.

When you check the list of features offered by the PLA-219, PLA-419, PLA-2150, PLA-2250, PLA-2350, PLA-2450, PLA-2550, PLA-2650, PLA-2750, PLA-2850, PLA-4150, PLA-4250, PLA-4350, PLA-4300D you'll know you made the right choice with a Pyle Power amplifier.



table of contents

general features	2-6	2/4 channel input connections	
features and specifications		PLA-419	24-25
PLA-219	7-8	high level input connections	
PLA-419	9-10	PLA-4150/PLA-4250/PLA-4350	27
PLA-2150/PLA-2250/PLA-2350	11-14	mono input connections	
PLA-2450/PLA-2550/PLA-2650		PLA-4150/PLA-4250/PLA-4350	28
PLA-2750/PLA-2850		high level mono input connections	
PLA-4150/PLA-4250/PLA-4350	15-16	PLA-4150/PLA-4250/PLA-4350	29
PLA-4300D	17-18	system wiring	30
electrical connections		PLA-4300D	
PLA-219/PLA-419/PLA-2150/PLA-2250	19-20	speaker connections	
PLA-2350/PLA-2450/PLA-2550		PLA-2150/PLA-2250/PLA-2350	31
PLA-2650/PLA-2750/PLA-2850		PLA-2450/PLA-2550/PLA-2650	
PLA-4150/PLA-4250/PLA-4350		PLA-2750/PLA-2850	
PLA-4300D		speaker connections	
stereo input connections		PLA-419/PLA-4150	32-33
PLA-219/PLA-2150/PLA-2250/PLA-2350	21-22	PLA-4250/PLA-4350	
PLA-2450/PLA-2550/PLA-2650		mounting and installation	34
PLA-2750/PLA-2850		protection circuitry and troubleshooting	35
mono input connections		precautions	36
PLA-2150/PLA-2250/PLA-2350	23		
PLA-2450/PLA-2550/PLA-2650			
PLA-2750/PLA-2850			



general features

PLA-219

High Performance 240 Watt 2 Channel Amplifier

- 120 Watts x 2 Output
- Variable Input Level (Gain) Control
- Remote Turn On/Off
- Gold Plated RCA Inputs
- High Level MOLEX Input
- Power ON LED Indicator
- S/N Ratio: > 95 dB
- THD: <0.04%
- Thermal Protection
- Overload Protection
- Short Circuit Protection
- Anti-Thump Turn-On

PLA-419

High Performance 400 Watt 4 Channel Amplifier

- 100 Watts x 4 Output
- Variable Input Level (Gain) Control
- Remote Turn On/Off
- Gold Plated RCA Inputs
- High Level MOLEX Input
- Power ON LED Indicator
- S/N Ratio: > 95 dB
- THD: <0.04%
- Thermal Protection
- Overload Protection
- Short Circuit Protection
- Anti-Thump Turn-On

PLA-2150

High Performance 600 Watt 2 Channel Bridgeable MOSFET Amplifier

- 300 Watts x 2 Output
- 600 Watts x 1 Bridged Output
- Variable Hi/Lo Electronic Crossover Network
- Variable Bass Boost (0 - +18 dB @ 60Hz)
- Variable Input Level (Gain) Control
- Remote Turn On/Off
- Gold Plated RCA Inputs
- High Level MOLEX Input
- Power ON LED Indicator
- LED Protection Indicator
- S/N Ratio: > 95 dB
- THD: <0.04%
- Thermal Protection
- Overload Protection
- Short Circuit Protection
- Anti-Thump Turn-On



general features

PLA-2250

High Performance 1000 Watt 2 Channel
Bridgeable MOSFET Amplifier

- 500 Watts x 2 Output
- 1000W x 1 Bridged Output
- Variable Hi/Lo Electronic Crossover Network
- Variable Bass Boost (0 - +18 dB @ 60Hz)
- Variable Input Level (Gain) Control
- Remote Turn On/Off
- Gold Plated RCA Inputs
- High Level MOLEX Inputs
- Power ON LED Indicator
- LED Protection Indicator
- Remote Bass Boost
- S/N Ratio: > 95 dB
- THD: <0.04%
- Thermal Protection
- Overload Protection
- Short Circuit Protection
- Anti-Thump Turn-On

PLA-2350

High Performance 1200 Watt 2 Channel
Bridgeable MOSFET Amplifier

- 600 Watts x 2 Output
- 1200W x 1 Bridged Output
- Variable Hi/Lo Electronic Crossover Network
- Variable Bass Boost (0 - +18 dB @ 60Hz)
- Variable Input Level (Gain) Control
- Remote Turn On/Off
- Gold Plated RCA Inputs
- High Level MOLEX Inputs
- Power ON LED Indicator
- LED Protection Indicator
- Remote Bass Boost
- S/N Ratio: > 95 dB
- THD: <0.04%
- Thermal Protection
- Overload Protection
- Short Circuit Protection
- Anti-Thump Turn-On

PLA-2450

High Performance 1400 Watt 2 Channel
Bridgeable MOSFET Amplifier

- 700 Watts x 2 Output
- 1400W x 1 Bridged Output
- Variable Hi/Lo Electronic Crossover Network
- Variable Bass Boost (0 - +18 dB @ 60Hz)
- Variable Input Level (Gain) Control
- Remote Turn On/Off
- Gold Plated RCA Inputs
- High Level MOLEX Inputs
- Power ON LED Indicator
- LED Protection Indicator
- Remote Bass Boost
- S/N Ratio: > 95 dB
- THD: <0.04%
- Thermal Protection
- Overload Protection
- Short Circuit Protection
- Anti-Thump Turn-On



general features

PLA-2550

High Performance 1600 Watt 2 Channel
Bridgeable MOSFET Amplifier

- 800 Watts x 2 Output
- 1600 Watts x 1 Bridged Output
- Variable Hi/Lo Electronic Crossover Network
- Variable Bass Boost (0 - +18 dB @ 60Hz)
- Variable Input Level (Gain) Control
- Remote Turn On/Off
- Gold Plated RCA Inputs
- High Level MOLEX Input
- Power ON LED Indicator
- LED Protection Indicator
- Remote Bass Boost
- S/N Ratio: > 95 dB
- THD: <0.04%
- Thermal Protection
- Overload Protection
- Short Circuit Protection
- Anti-Thump Turn-On

PLA-2650

High Performance 1800 Watt 2 Channel
Bridgeable MOSFET Amplifier

- 900 Watts x 2 Output
- 1800 Watts x 1 Bridged Output
- Variable Hi/Lo Electronic Crossover Network
- Variable Bass Boost (0 - +18 dB @ 60Hz)
- Variable Input Level (Gain) Control
- Remote Turn On/Off
- Gold Plated RCA Inputs
- High Level MOLEX Input
- Power ON LED Indicator
- LED Protection Indicator
- Remote Bass Boost
- S/N Ratio: > 95 dB
- THD: <0.04%
- Thermal Protection
- Overload Protection
- Short Circuit Protection
- Anti-Thump Turn-On

PLA-2750

High Performance 2400 Watt 2 Channel
Bridgeable MOSFET Amplifier

- 1200 Watts x 2 Output
- 2400 Watts x 1 Bridged Output
- Variable Hi/Lo Electronic Crossover Network
- Variable Bass Boost (0 - +18 dB @ 60Hz)
- Variable Input Level (Gain) Control
- Remote Turn On/Off
- Gold Plated RCA Inputs
- High Level MOLEX Input
- Power ON LED Indicator
- LED Protection Indicator
- Remote Bass Boost
- S/N Ratio: > 95 dB
- THD: <0.04%
- Thermal Protection
- Overload Protection
- Short Circuit Protection
- Anti-Thump Turn-On



general features

PLA-2850

High Performance 4000 Watt 2 Channel
Bridgeable MOSFET Amplifier

- 2000 Watts x 2 Output
- 4000 Watts x 1 Bridged Output
- Variable Hi/Lo Electronic Crossover Network
- Variable Bass Boost (0 - +18 dB @ 60Hz)
- Variable Input Level (Gain) Control
- Remote Turn On/Off
- Gold Plated RCA Inputs
- High Level MOLEX Input
- Power ON LED Indicator
- LED Protection Indicator
- Remote Bass Boost
- S/N Ratio: > 95 dB
- THD: <0.04%
- Thermal Protection
- Overload Protection
- Short Circuit Protection
- Anti-Thump Turn-On

PLA-4150

High Performance 1000 Watt 4 Channel
Bridgeable MOSFET Amplifier

- 250 Watts x 4 Output
- 500 Watts x 2 Bridged Output (250Wx2+500Wx1)
- Dual Variable Hi/Lo Electronic Crossover Network
- Dual Variable Bass Boost (0 - +18 dB @ 60Hz)
- Variable Input Level (Gain) Control
- Remote Turn On/Off
- Gold Plated RCA Inputs
- High Level MOLEX Input
- Power ON LED Indicator
- LED Protection Indicator
- S/N Ratio: > 95 dB
- THD: <0.04%
- Thermal Protection
- Overload Protection
- Short Circuit Protection
- Anti-Thump Turn-On
- Tri-Mode Configurable

PLA-4250

High Performance 1400 Watt 4 Channel
Bridgeable MOSFET Amplifier

- 350 Watts x 4 Output
- 700 Watts x 2 Bridged Output (350Wx2+700Wx1)
- Dual Variable Hi/Lo Electronic Crossover Network
- Dual Variable Bass Boost (0 - +18 dB @ 60Hz)
- Variable Input Level (Gain) Control
- Remote Turn On/Off
- Gold Plated RCA Inputs
- High Level MOLEX Input
- Power ON LED Indicator
- LED Protection Indicator
- Remote Bass Boost
- S/N Ratio: > 95 dB
- THD: <0.04%
- Thermal Protection
- Overload Protection
- Short Circuit Protection
- Anti-Thump Turn-On
- Tri-Mode Configurable



general features

PLA-4350

High Performance 2000 Watt 4 Channel
Bridgeable MOSFET Amplifier

- 500 Watts x 4 Output
- 1000W x 2 Bridged Output (500W x 2+1000W x 1)
- Dual Variable Hi/Lo Electronic Crossover Network
- Dual Variable Bass Boost (0 - +18 dB @ 60Hz)
- Variable Input Level (Gain) Control
- Remote Turn On/Off
- Gold Plated RCA Inputs
- High Level MOLEX Inputs
- Power ON LED Indicator
- LED Protection Indicator
- Remote Bass Boost
- S/N Ratio: > 95 dB
- THD: <0.04%
- Thermal Protection
- Overload Protection
- Short Circuit Protection
- Anti-Thump Turn-On
- Tri-Mode Configurable

PLA-4300D

4000W Mono Block MOSFET Amplifier

- Mono Block Subwoofer Amplifier
- 1 Ohm Stable
- MOSFET Power Supply
- PWM (Pulse-Width-Modulation) System
- Glass Epoxy PCB
- Gold Plated RCA Inputs for Line Input & Bypass Output.
- Gold Plated Terminals for Speaker Output and Power Input.
- Thermal, Overload and Short Protection
- Variable Sub-sonic Filter (15Hz-40Hz, 24dB/Octave)
- Variable Low-pass Filter (20Hz-250Hz, 24dB/Octave)
- Phase Control 0-180 degree
- Remote Bass Control
- Input Impedance : 10K Ohms
- Soft Turn On/Off
- Advanced Protection Circuitry
- S/N Ratio:>90dB
- Heavy Duty Power Coated Heatsink



features and controls

2 ch amp PLA-219

PLA-219

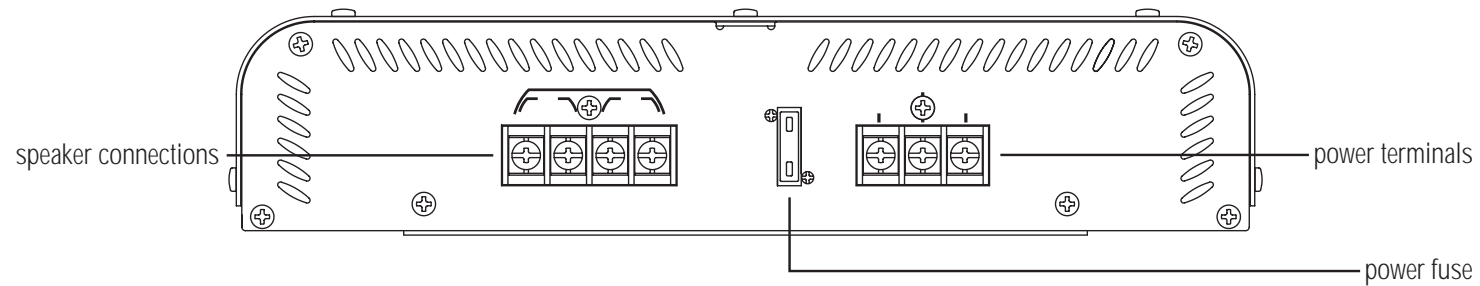
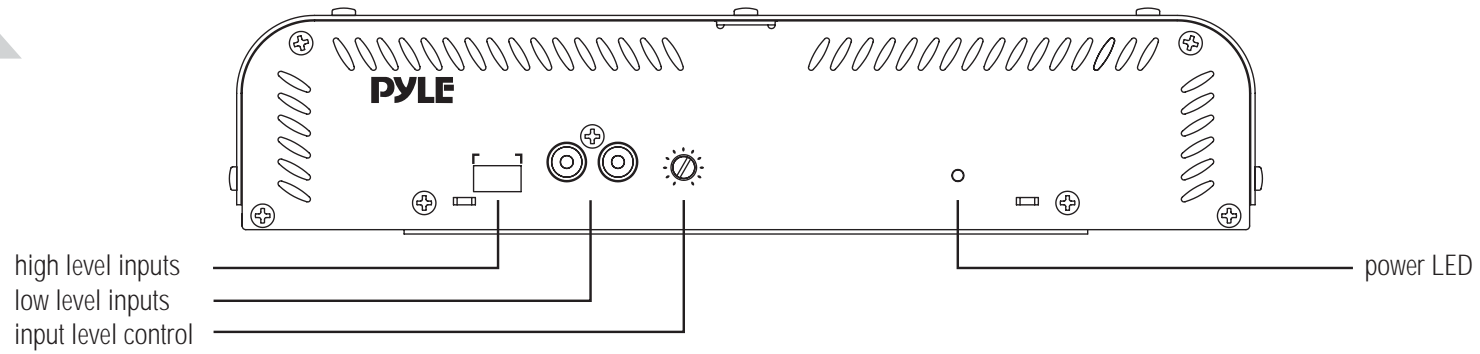



features and specifications

2 ch amp PLA-219

input level control use this control to match the outputs of your head unit to the amplifier. Starting with your head unit set at about the 2 o'clock position, increase the amp level control until distortion begins to occur, and reduce slightly from this point.

low level inputs this amp features gold-plated RCA input jacks for high impedance input. Use these with car stereo output which uses RCA-type connector cables.

high level inputs if your car stereo lacks RCA-type output jacks, you may connect speaker output leads to these input connectors.

power LED this indicator is illuminated when power is applied.

power fuse the fuse protects the amplifier and your car's electrical system from short circuit conditions.

power terminals use these connectors to deliver power, ground and remote turn-on control to the amplifier.

speaker connections these terminals are 14K gold plated to guarantee high conductivity and minimum signal loss.

output power @ 14.4v DC, 1KHz

RMS Power @ 4 Ohms 30 Watts x 2
Maximum Power Output 120 Watts x 2

frequency response 15 Hz-30 KHz

input impedance
low level inputs 10K Ohms
high level inputs 100 Ohms

input sensitivity
low level inputs 250mV
high level inputs 2.5V

power supply voltage 14.4V DC Neg. Ground (10.5-16V)

matching speaker impedance
stereo mode 2-4 Ohms

maximum current draw 5A

dimensions (W x H x L)
mm 281 x 59 x 209
inches 11.06 x 2.32 x 8.25





features and controls

4 ch amp PLA-419

PLA-419

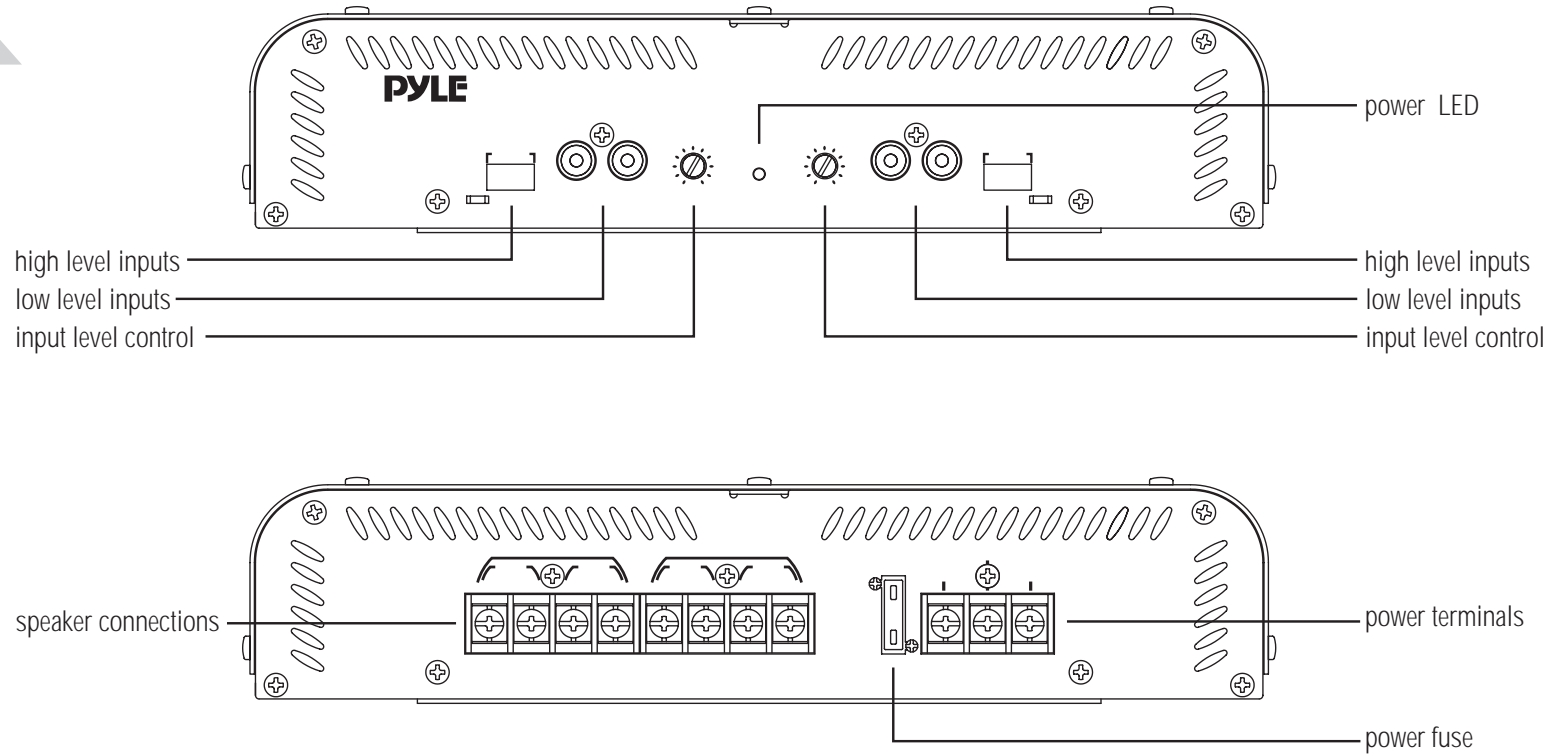



features and specifications

4 ch amp PLA-419

input level control use this control to match the outputs of your head unit to the amplifier. Starting with your head unit set at about the 2 o'clock position, increase the amp level control until distortion begins to occur, and reduce slightly from this point.

low level inputs this amp features gold-plated RCA input jacks for high impedance input. Use these with car stereo output which uses RCA-type connector cables.

high level inputs if your car stereo lacks RCA-type output jacks, you may connect speaker output leads to these input connectors.

power LED this indicator is illuminated when power is applied.

power fuse the fuse protects the amplifier and your car's electrical system from short circuit conditions.

power terminals use these connectors to deliver power, ground and remote turn-on control to the amplifier.

speaker connections these terminals are 14K gold plated to guarantee high conductivity and minimum signal loss.

output power @ 14.4v DC, 1KHz

RMS Power @ 4 Ohms
Maximum Power Output

30 Watts x 4
100 Watts x 4

frequency response

15 Hz-30 KHz

input impedance

low level inputs
high level inputs

10K Ohms
100 Ohms

10

input sensitivity

low level inputs
high level inputs

250mV
2.5V

power supply voltage

14.4V DC Neg. Ground (10.5-16V)

matching speaker impedance

stereo mode

2-4 Ohms

maximum current draw

10A

dimensions (W x H x L)

mm
inches

281 x 59 x 235
11.06 x 2.32 x 9.25



features and controls

2 ch amp PLA-2150 • PLA-2250
PLA-2350 • PLA-2450

- PLA-2150
- PLA-2250
- PLA-2350
- PLA-2450

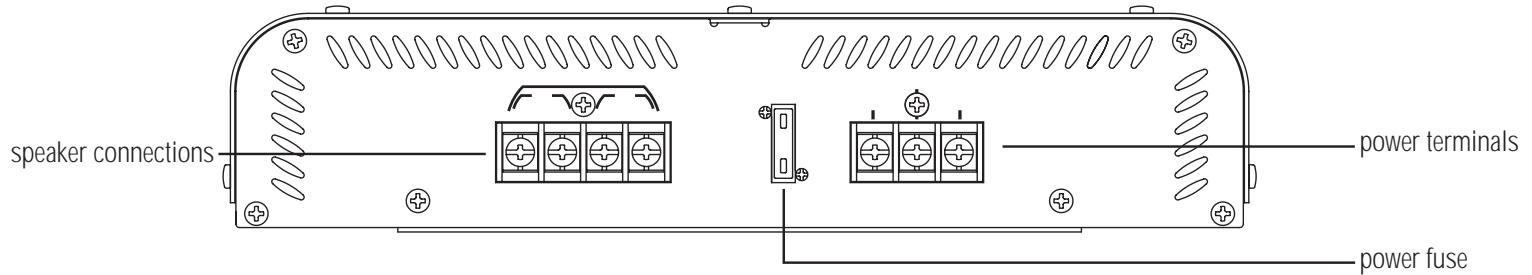
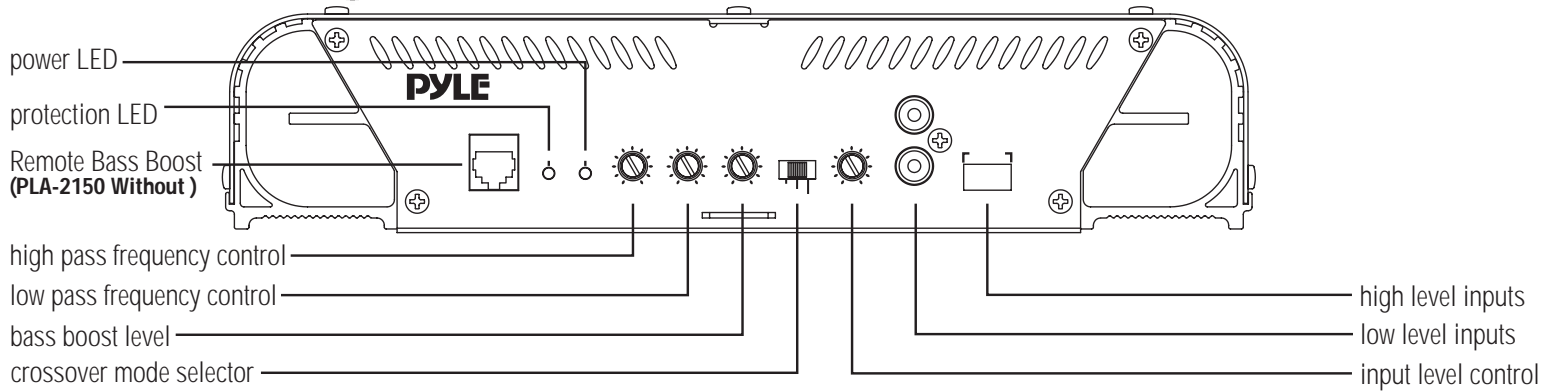



features and specifications

2 ch amp **PLA-2150 • PLA-2250**
PLA-2350 • PLA-2450

- crossover mode selector** when used with normal, full range systems, set this switch to "FULL." If you wish to use the internal crossover to power a driver of specific frequency range, use the "LOWPASS" or "HIGHPASS" settings.
- input level control** use this control to match the outputs of your head unit to the amplifier. Starting with your head unit set at about the 2 o'clock position, increase the amp level control until distortion begins to occur, and reduce slightly from this point.
- low pass frequency control** when the crossover selector switch is in "low pass" mode, this control sets the upper frequency limit for audio program sent to the speakers.
- high pass frequency control** when the crossover selector switch is in "high pass" mode, this control sets the lower frequency limit for audio program sent to the speakers.
- Remote Bass Boost** Plug in the Remote Bass Boost Control wire in here. (PLA-2150 without)
- bass boost level control** this control permits adjustment of the bass level up to an increase of approximately 18 dB.
- low level inputs** this amp features gold-plated RCA input jacks for high impedance input. Use these with car stereo output which uses RCA-type connector cables.
- high level inputs** if your car stereo lacks RCA-type output jacks, you may connect speaker output leads to these input connectors.
- power LED** this indicator is illuminated when power is applied.
- protection LED** this indicator is illuminated when built-in protection circuitry is activated.
- power fuse** the fuse protects the amplifier and your car's electrical system from short circuit conditions.
- power terminals** use these connectors to deliver power, ground and remote turn-on control to the amplifier.
- speaker connections** these terminals are 14K gold plated to guarantee high conductivity and minimum signal loss.

output power @ 14.4v DC, 1KHz	PLA-2150	PLA-2250	PLA-2350	PLA-2450
RMS Power @ 4 Ohms	40 Watts x 2	75 Watts x 2	75 Watts x 2	100 Watts x 2
RMS Power @ 2 Ohms	60 Watts x 2	125 Watts x 2	125 Watts x 2	175 Watts x 2
Maximum Power Output	300 Watts x 2	500 Watts x 2	600 Watts x 2	700 Watts x 2

frequency response ————— 15 Hz-30 KHz —————

input impedance

low level inputs ————— 10K Ohms —————
high level inputs ————— 100 Ohms —————

input sensitivity

low level inputs ————— 250mV —————
high level inputs ————— 2.5V —————

power supply voltage ————— 14.4V DC Neg. Ground (10.5-16V) —————

matching speaker impedance

stereo mode ————— 2-4 Ohms —————
bridged mode ————— 4-8 Ohms —————

maximum current draw 15A 15A 20A 30A

dimensions (W x H x L)

mm	281 x 59 x 209	281 x 59 x 280	281 x 59 x 305	281 x 59 x 343
inches	11.06 x 2.32 x 8.25	11.06 x 2.32 x 11	11.06 x 2.32 x 12	11.06 x 2.32 x 13.5





features and controls

2 ch amp PLA-2550 • PLA-2650
PLA-2750 • PLA-2850

- PLA-2550
- PLA-2650
- PLA-2750
- PLA-2850

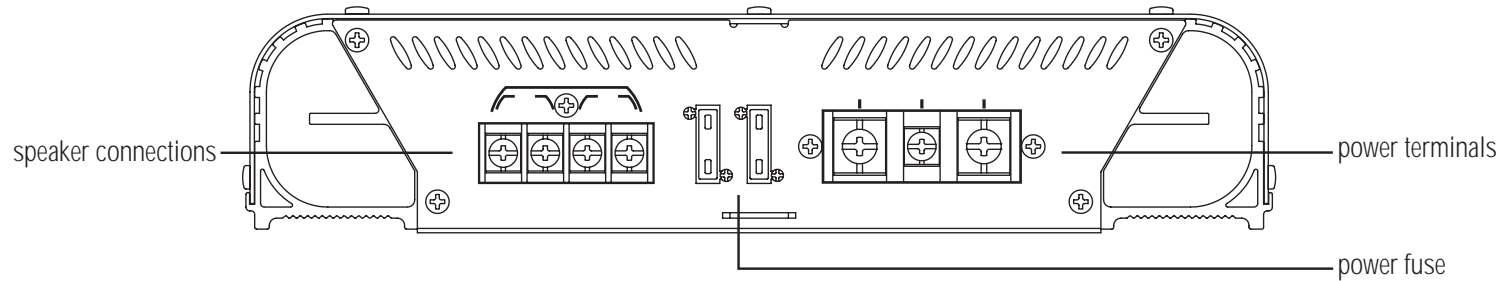
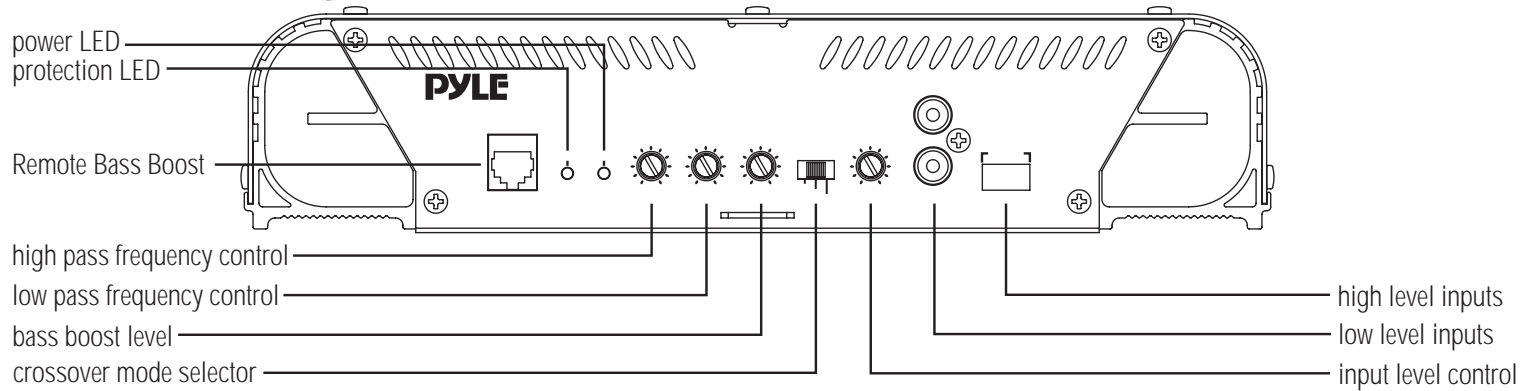



features and specifications

2 ch amp **PLA-2550 • PLA-2650**
PLA-2750 • PLA-2850

- crossover mode selectors** when used with normal, full range systems, set these switches to "FULL." If you wish to use the internal crossovers to power a driver of specific frequency range, use the "LOWPASS" or "HIGHPASS" settings.
- input level controls** use these controls to match the outputs of your head unit to the amplifier. Starting with your head unit set at about the 2 o'clock position, increase the amp level controls until distortion begins to occur, and reduce slightly from this point.
- low pass frequency controls** when one or both of the crossover selector switches is in "low pass" mode, one can set the upper frequency limit for audio program sent to the speakers.
- high pass frequency controls** when the one or both of crossover selector switch is in "high pass" mode, one can set the lower frequency limit for audio program sent to the speakers.
- Remote Bass Boost** Plug in the Remote Bass Boost Control wire in here.
- bass boost level controls** this control permits adjustment of the bass level up to an increase of approximately 18 dB in either or both pairs of channels.
- low level inputs** this amp features gold-plated RCA input jacks for high impedance input. Use these with car stereo output which uses RCA-type connector cables.
- high level inputs** if your car stereo lacks RCA-type output jacks, you may connect speaker output leads to these input connectors.
- power LED** this indicator is illuminated when power is applied.
- protection LED** this indicator is illuminated when built-in protection circuitry is activated.
- power fuse** the fuse protects the amplifier and your car's electrical system from short circuit conditions.
- power terminals** use these connectors to deliver power, ground and remote turn-on control to the amplifier.
- speaker connections** these terminals are 14K gold plated to guarantee high conductivity and minimum signal loss.

output power @ 14.4v DC, 1KHz	PLA-2550	PLA-2650	PLA-2750	PLA-2850
RMS Power @ 4 Ohms	125 Watts x 2	150 Watts x 2	200 Watts x 2	300 Watts x 2
RMS Power @ 2 Ohms	200 Watts x 2	225 Watts x 2	290 Watts x 2	450 Watts x 2
Maximum Power Output	800 Watts x 2	900 Watts x 2	1200 Watts x 2	2000 Watts x 2

frequency response _____ 15 Hz-30 KHz _____

input impedance
low level inputs _____ 10K Ohms _____
high level inputs _____ 100 Ohms _____

input sensitivity
low level inputs _____ 250mV _____
high level inputs _____ 2.5V _____

power supply voltage _____ 14.4V DC Neg. Ground (10.5-16V) _____

matching speaker impedance
stereo mode _____ 2-4 Ohms _____
bridged mode _____ 4-8 Ohms _____

maximum current draw 20 A 20 A x 2 25 A x 2 30 A x 2

dimensions (W x H x L)
mm 281 x 59 x 381 281 x 59 x 432 281 x 59 x 482 281 x 59 x 532
inches 11.06 x 2.32 x 15 11.06 x 2.32 x 17 11.06 x 2.32 x 19 11.06 x 2.32 x 21

14



features and controls

4 ch amp PLA-4150 • PLA-4250 • PLA-4350

- PLA-4150
- PLA-4250
- PLA-4350

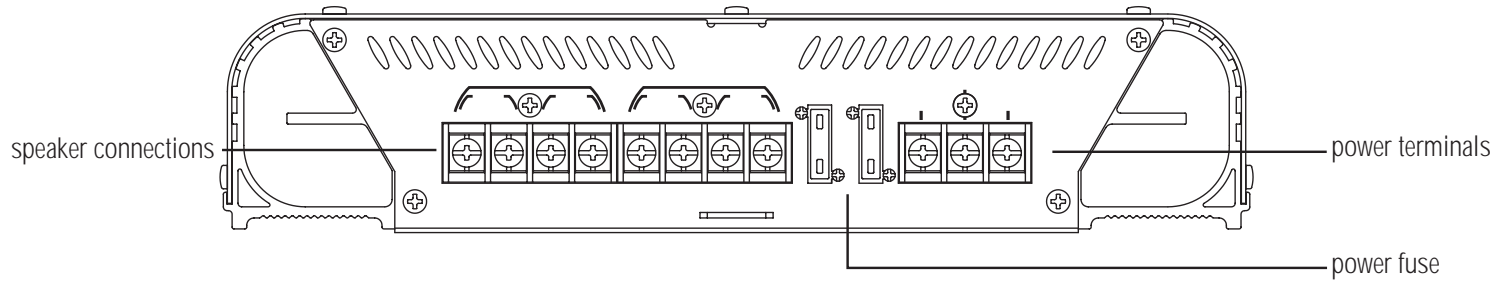
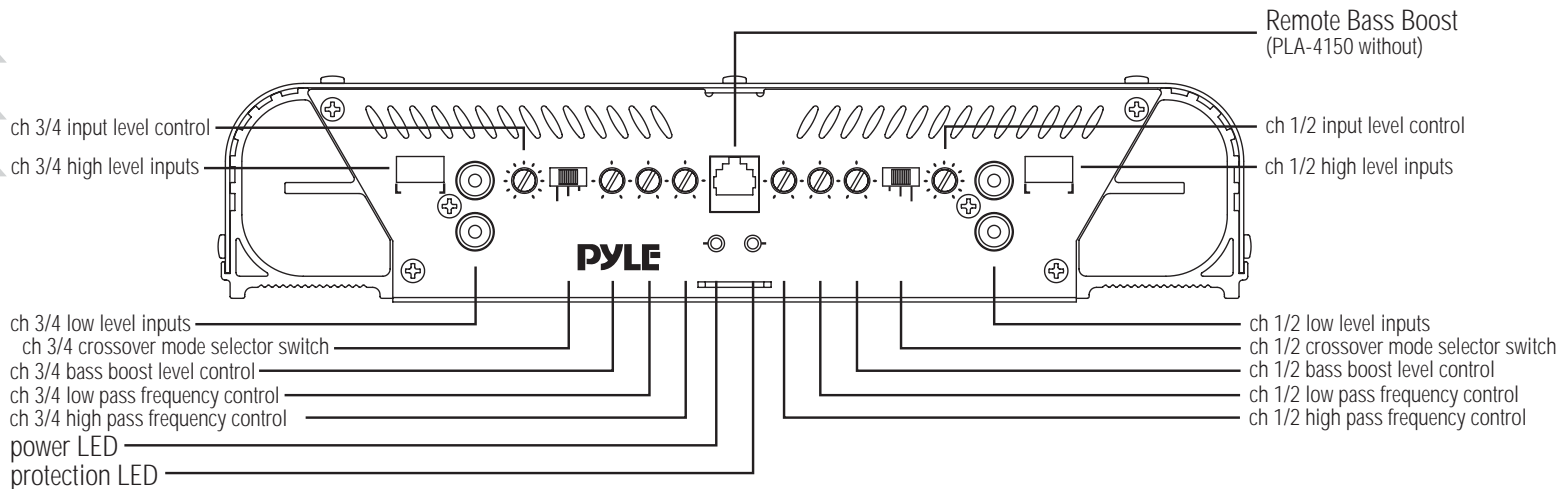



features and specifications

4 ch amp PLA-4150 • PLA-4250 • PLA-4350

- dual crossover mode selectors** when used with normal, full range systems, set these switches to "FULL." If you wish to use the internal crossovers to power a driver of specific frequency range, use the "LOWPASS" or "HIGHPASS" settings.
- dual input level controls** use these controls to match the outputs of your head unit to the amplifier. Starting with your head unit set at about the 2 o'clock position, increase the amp level controls until distortion begins to occur, and reduce slightly from this point.
- dual low pass frequency controls** when one or both of the crossover selector switches is in "low pass" mode, one can set the upper frequency limit for audio program sent to the speakers.
- dual high pass frequency controls** when the one or both of crossover selector switch is in "high pass" mode, one can set the lower frequency limit for audio program sent to the speakers.
- CH 3/4 Remote Bass Boost** Plug in the Remote Bass Boost Control wire in here.(PLA-4150 without)
- dual bass boost level controls** this control permits adjustment of the bass level up to an increase of approximately 18 dB in either or both pairs of channels.
- low level inputs** this amp features gold-plated RCA input jacks for high impedance input. Use these with car stereo output which uses RCA-type connector cables.
- high level inputs** if your car stereo lacks RCA-type output jacks, you may connect speaker output leads to these input connectors.
- power LED** this indicator is illuminated when power is applied.
- protection LED** this indicator is illuminated when built-in protection circuitry is activated.
- power fuse** the fuse protects the amplifier and your car's electrical system from short circuit conditions.
- power terminals** use these connectors to deliver power, ground and remote turn-on control to the amplifier.
- speaker connections** these terminals are 14K gold plated to guarantee high conductivity and minimum signal loss.

output power @ 14.4v DC, 1KHz	PLA-4150	PLA-4250	PLA-4350
RMS Power @ 4 Ohms	35 Watts x 4	50 Watts x 4	75 Watts x 4
RMS Power @ 2 Ohms	55 Watts x 4	75 Watts x 4	115 Watts x 4
Maximum Power Output	250 Watts x 4	350 Watts x 4	500 Watts x 4
frequency response	15 Hz-30 KHz		
input impedance			
low level inputs	10K Ohms		
high level inputs	100 Ohms		
input sensitivity			
low level inputs	250mV		
high level inputs	2.5V		
power supply voltage	14.4V DC Neg. Ground (10.5-16V)		
matching speaker impedance			
stereo mode	2-4 Ohms		
bridged mode	4-8 Ohms		
maximum current draw	20 A	30 A	20 A x 2
dimensions (W x H x L)			
mm	281 x 59 x 305	281 x 59 x 381	281 x 59 x 432
inches	11.06 x 2.32 x 12	11.06 x 2.32 x 15	11.06 x 2.32 x 17



features and controls

Class-D MONO BLOCK AMPLIFIER PLA-4300D

PLA-4300D

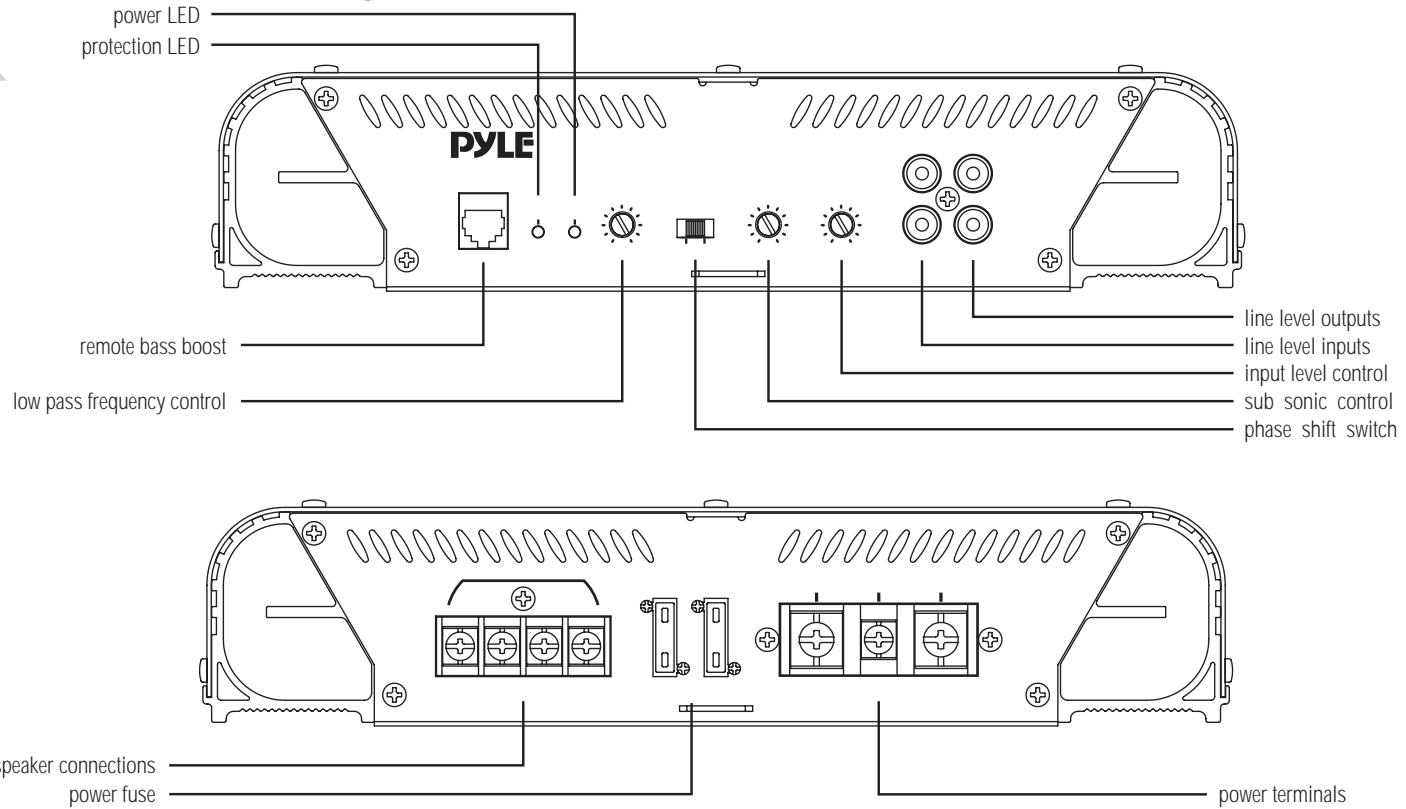



features and specifications

Class-D MONO BLOCK AMPLIFIER PLA-4300D

- Class-D design** Low-frequency information for subwoofer only.High efficient power
- power supplies** Stiffly regulated PWM power supplies. MOSFET switches maintain rated power over a wide range of battery voltages.
- crossover low pass filter** Adjustable from 20Hz to 250Hz with a slope of 24dB per octave.This allows for the adjustment of the upper point of the frequency bandwidth and the respective subwoofer.
- high pass subsonic filter** Adjustable from 15Hz to 40Hz with a slope of 24dB per octave.This allows for the attenuation of frequencies that are mostly inaudible and cause unnecessary strain on the amplifier.
- protection circuitry** Protection against thermal, overload and short circuit conditions.
- remote dash-mount gain control** This amplifier come complete with a compact remote GAIN CONTROLLER which can be conveniently mounted on or under the dashboard of your car.

output power @ 14.4v DC, 50Hz

RMS Power at @ 4 Ohms
RMS Power at @ 2 Ohms
RMS Power at @ 1.3 Ohms
Maximum Power Output

PLA-4300D

400W MONO
700W MONO
1200W MONO
4000W MONO

frequency response

20 Hz-250 Hz (-3dB)

input impedance

10K Ohms

input sensitivity

250mV-4V Adjustable

power supply voltage

14.4V DC Neg. Ground (10.5-16V)

min speaker Impedance

1 Ohm

T.H.D

0.1%

S/N ration

>90dB

fuse

40A x 2

dimensions (W x H x L)

mm
inches

281 x 59 x 381
11.06 x 2.32 x 15

18



electrical connections

2 ch amp PLA-219 • PLA-2150 • PLA-2250 • PLA-2350
PLA-2450 • PLA-2550 • PLA-2650 • PLA-2750
PLA-2850 • PLA-4300D

- PLA-219
- PLA-2150
- PLA-2250
- PLA-2350
- PLA-2450
- PLA-2550
- PLA-2650
- PLA-2750
- PLA-2850
- PLA-4300D

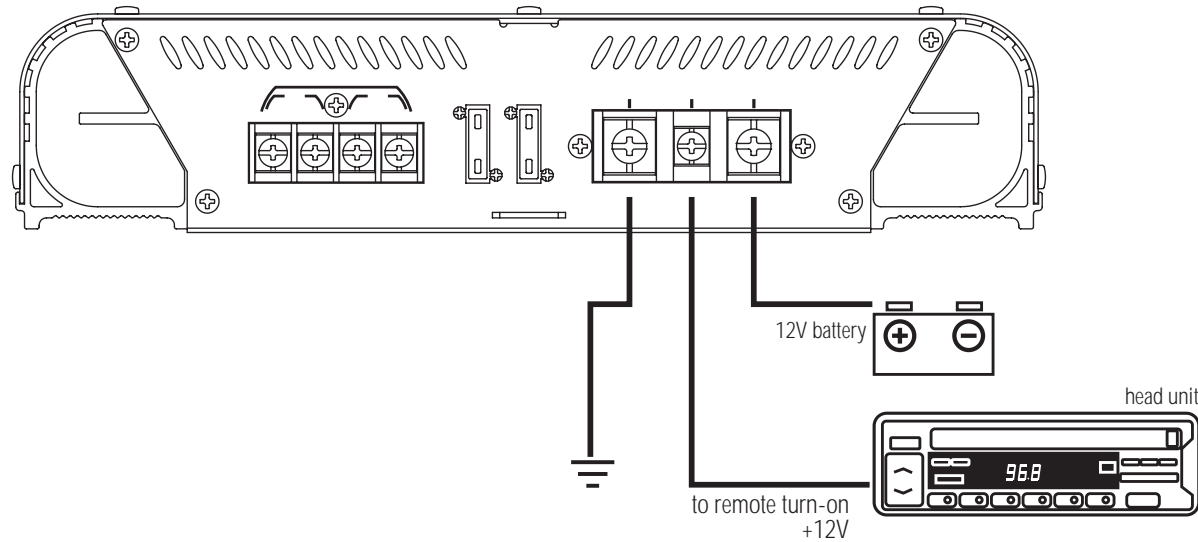



electrical connections

4 ch amp PLA-419 • PLA-4150
PLA-4250 • PLA-4350

- PLA-419
- PLA-4150
- PLA-4250
- PLA-4350

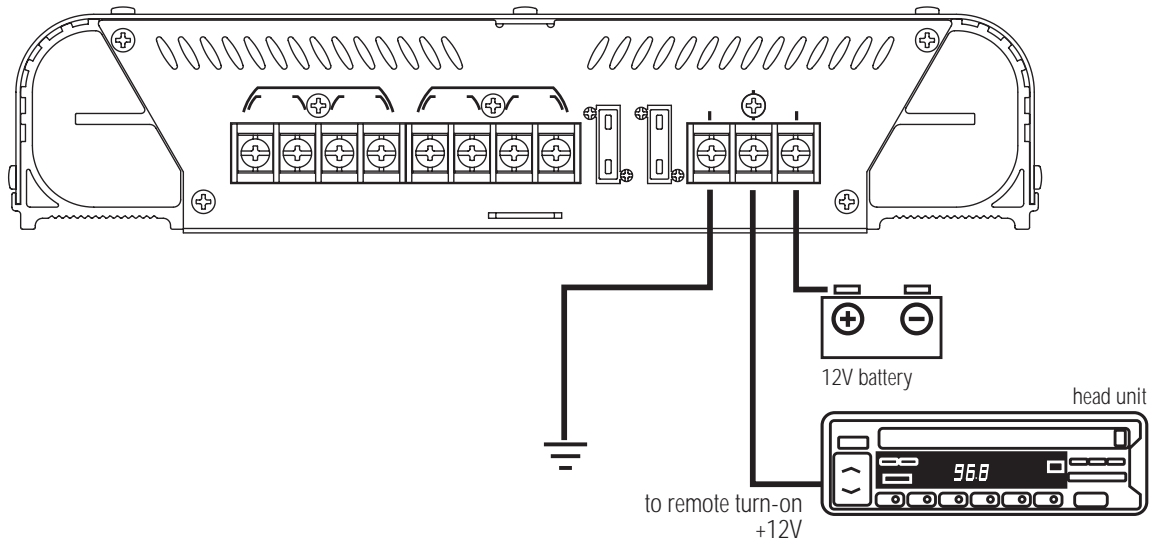



stereo input connections

2 ch amp PLA-219

using low level inputs

PLA-219

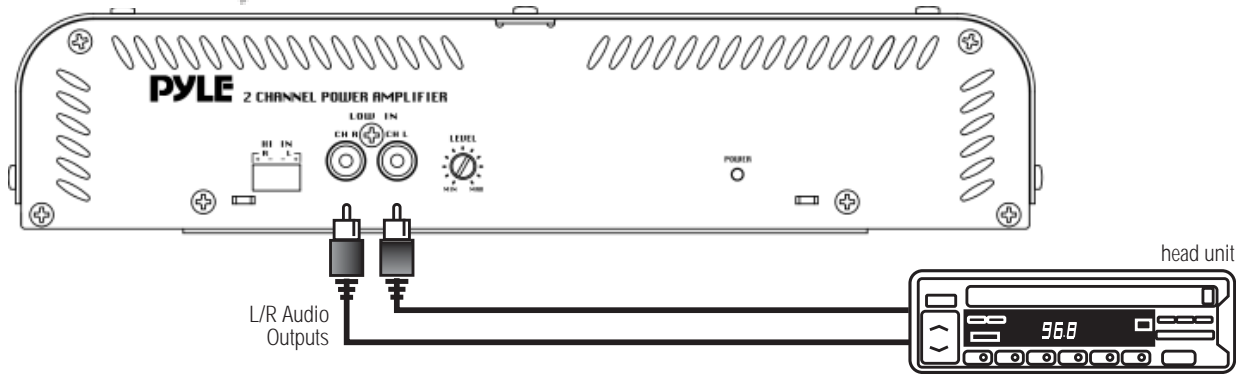

21

using high level inputs

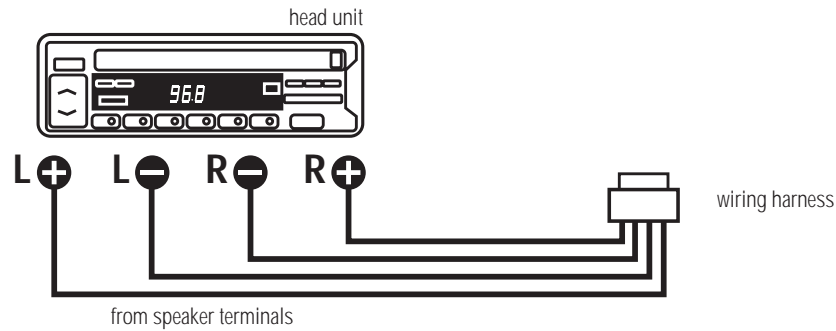

PLEASE NOTE! If using high level inputs, do not use the low level RCA inputs at the same time!



stereo input connections

2 ch amp • PLA-2150 • PLA-2250 • PLA-2350
 PLA-2450 • PLA-2550 • PLA-2650
 PLA-2750 • PLA-2850

using low level inputs

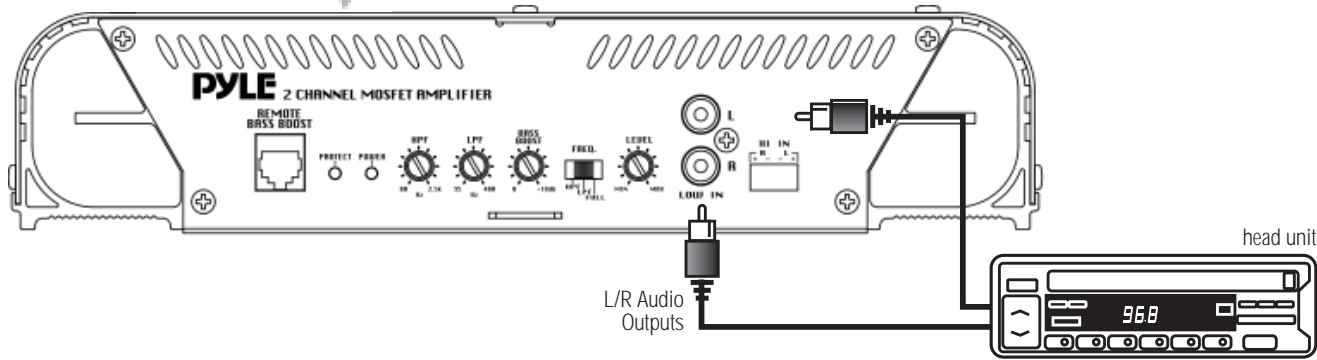

- PLA-2150
- PLA-2250
- PLA-2350
- PLA-2450
- PLA-2550
- PLA-2650
- PLA-2750
- PLA-2850

22

using high level inputs

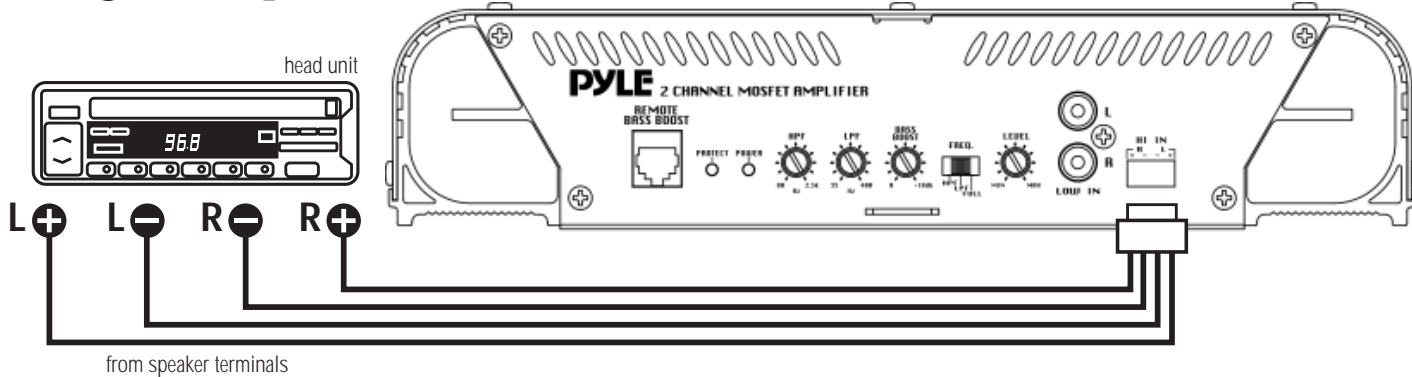

PLEASE NOTE! If using high level inputs, do not use the low level RCA inputs at the same time!



mono input connections

2 ch amp • PLA-2150 • PLA-2250 • PLA-2350
PLA-2450 • PLA-2550 • PLA-2650
PLA-2750 • PLA-2850

using low level inputs

- PLA-2150
- PLA-2250
- PLA-2350
- PLA-2450
- PLA-2550
- PLA-2650
- PLA-2750
- PLA-2850

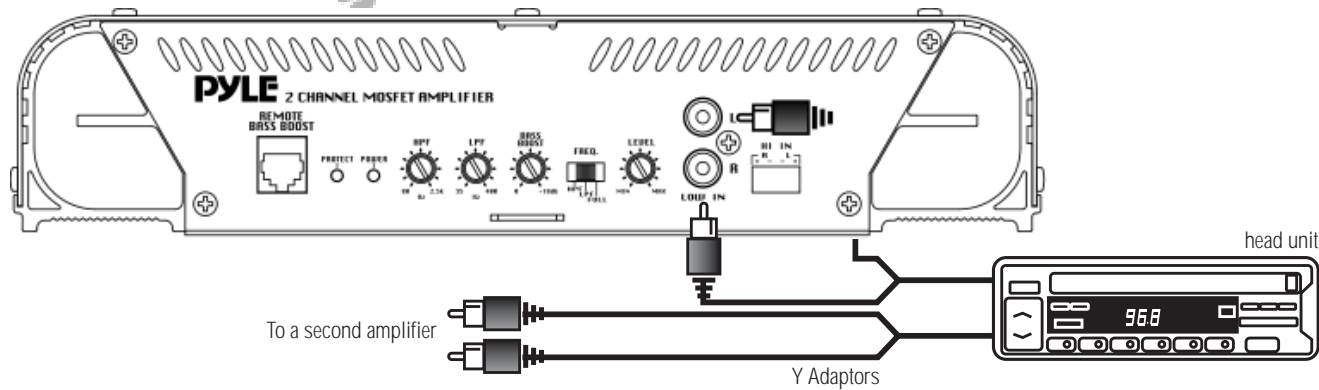

23

PLEASE NOTE! If using high level inputs, do not use the low level RCA inputs at the same time!

using high level inputs

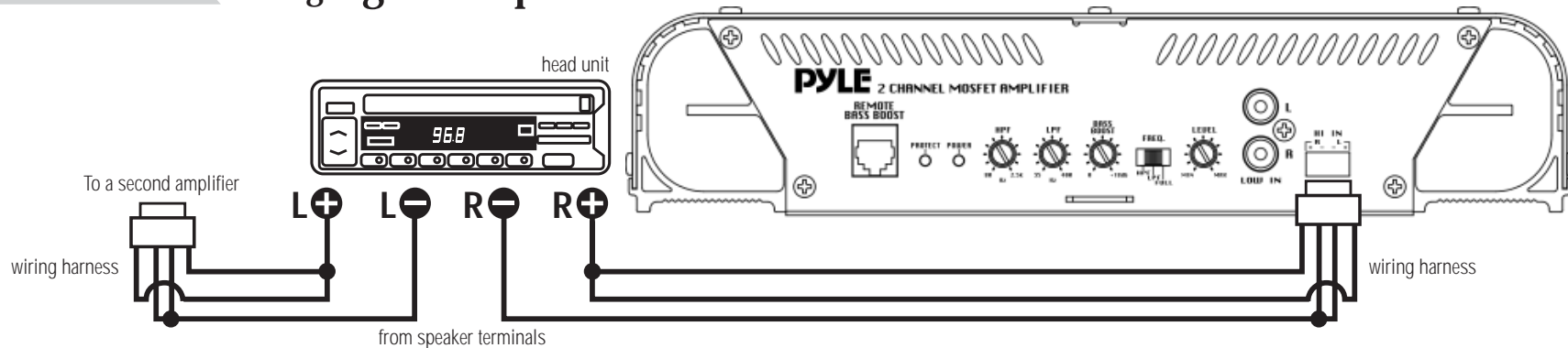

2/4 channel input connections

4 ch amp PLA-419

4 Channel connections using low level inputs

PLA-419

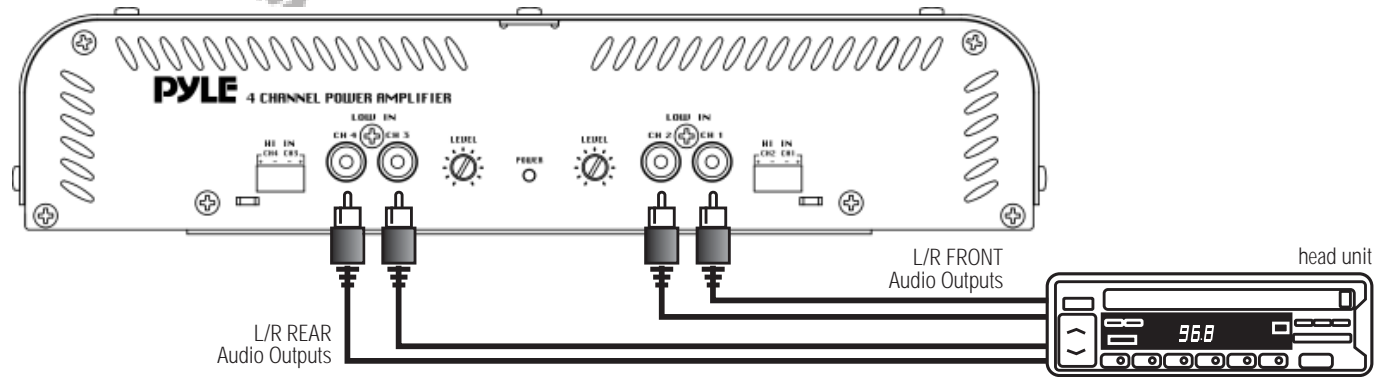

24

2 Channel connections using low level inputs

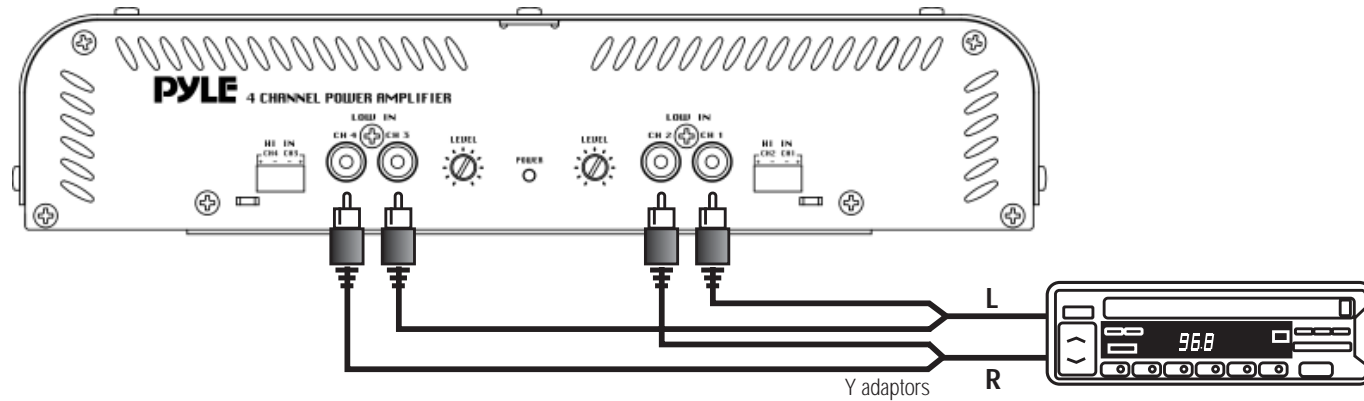

high level input connections 4 ch amp PLA-419

4 CH floating ground connections

PLA-419

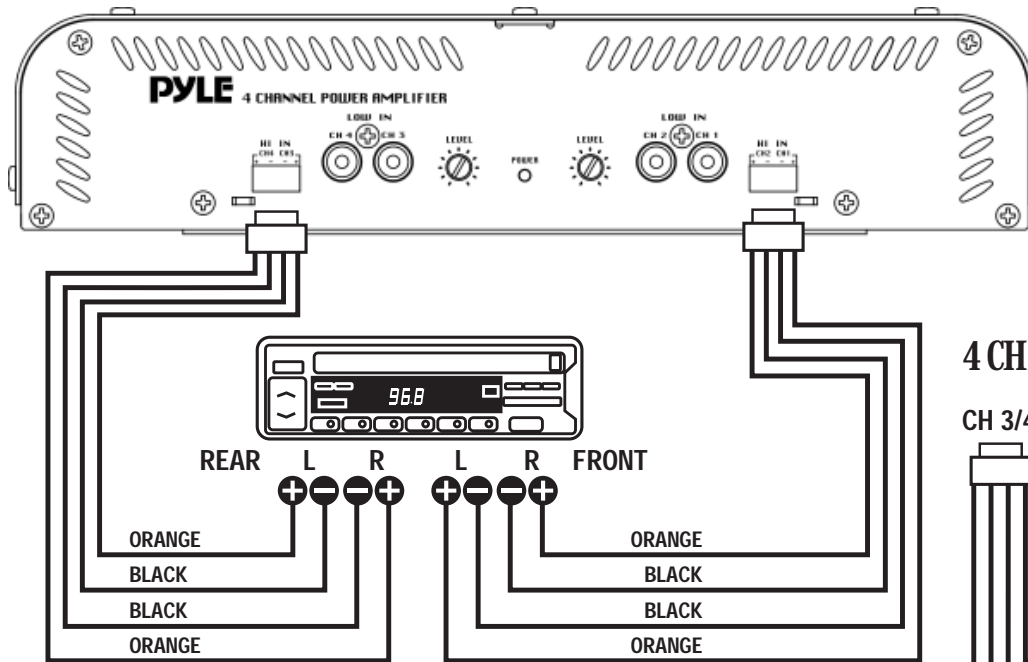

from speaker terminals

PLEASE NOTE! If using high level inputs, do not use the low level RCA inputs at the same time!

25

4 CH harness wiring for common ground connections

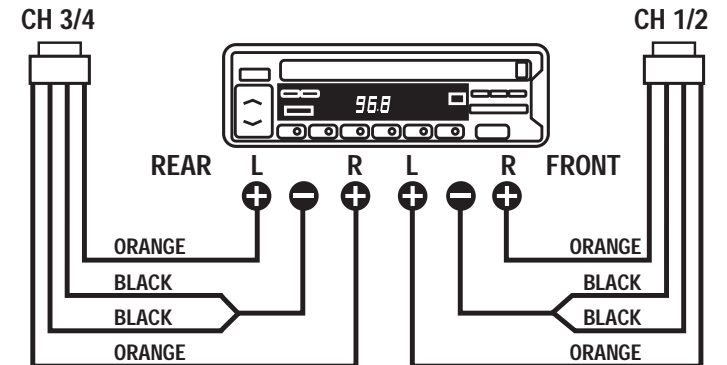

from speaker terminals



Stereo input connections

4 ch amp PLA-4150 • PLA-4250 • PLA-4350

4 CH Stereo input connections using low level inputs

- PLA-4150
- PLA-4250
- PLA-4350

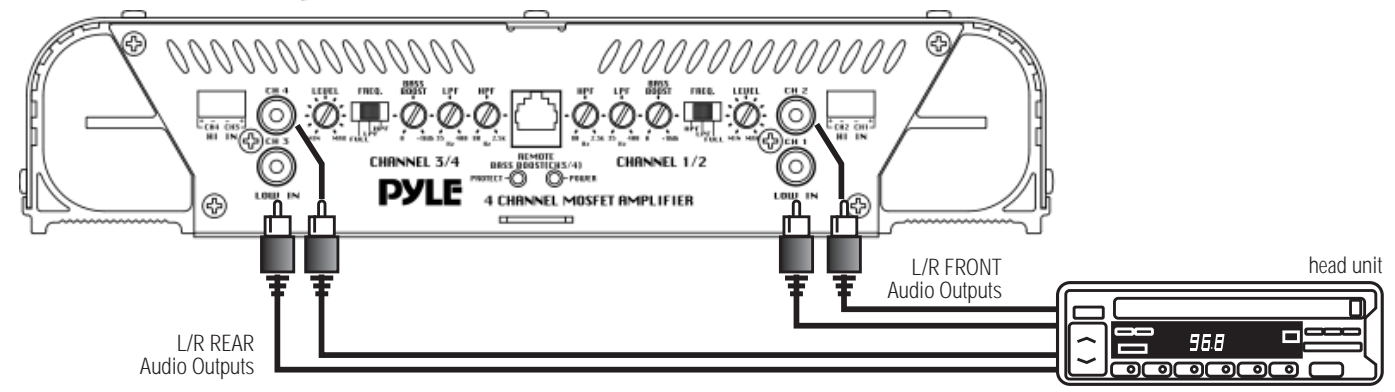

2 CH Stereo input connections using low level inputs

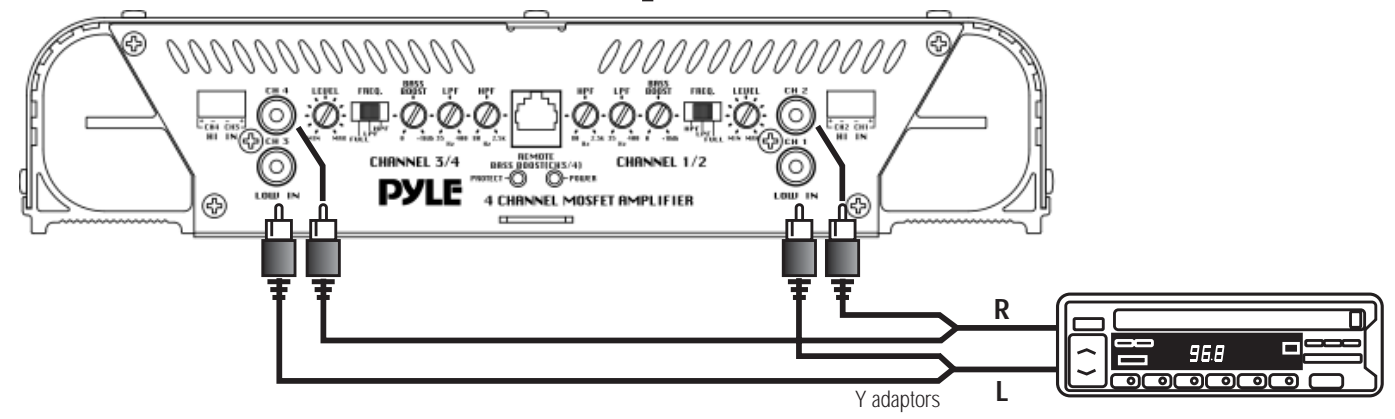

PYLE® GEAR

high level Stereo input connections

4 ch amp PLA-4150 • PLA-4250 • PLA-4350

4 CH floating ground connections

PLA-4150
PLA-4250
PLA-4350

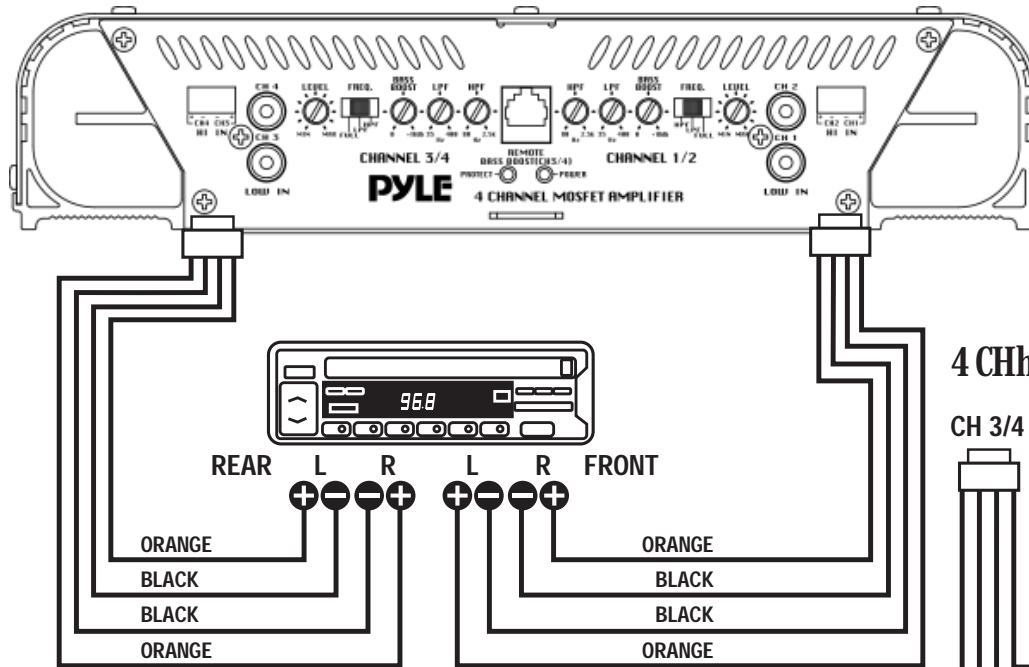

from speaker terminals

PLEASE NOTE! If using high level inputs, do not use the low level RCA inputs at the same time!

4 CH harness wiring for common ground connections

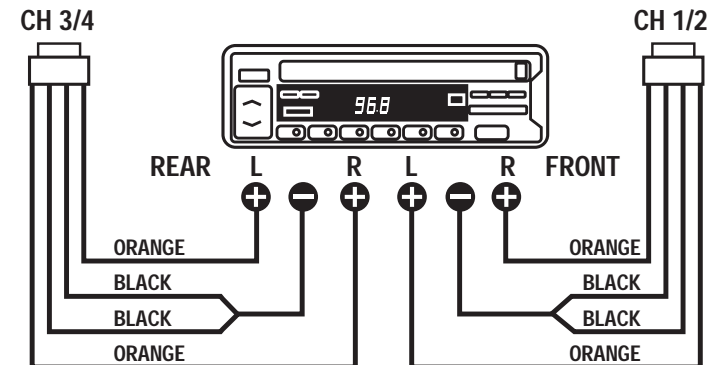

from speaker terminals

27



mono input connections

4 ch amp PLA-4150 • PLA-4250 • PLA-4350

4 CH mono input connections using low level inputs

- PLA-4150
- PLA-4250
- PLA-4350

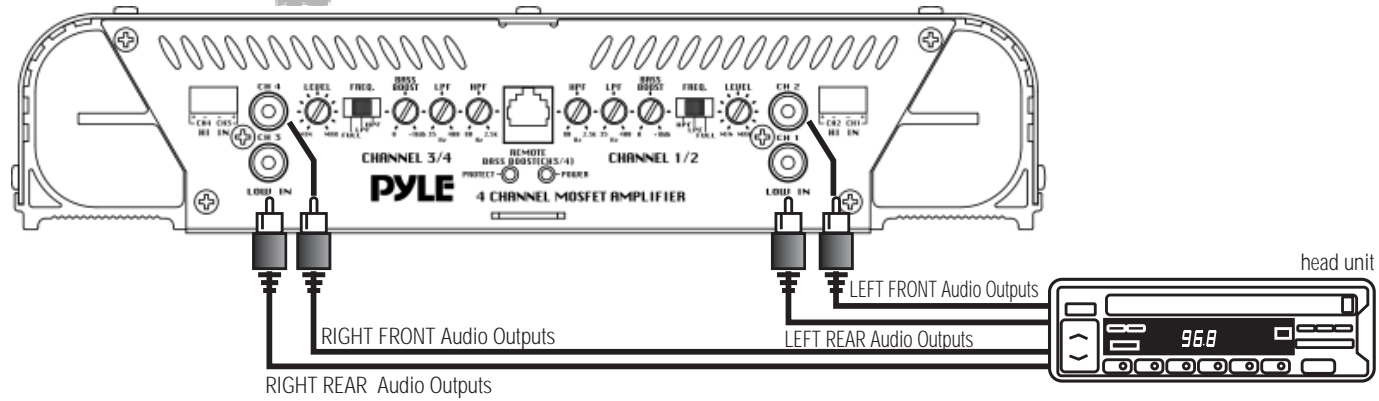

2 CH mono input connections using low level inputs

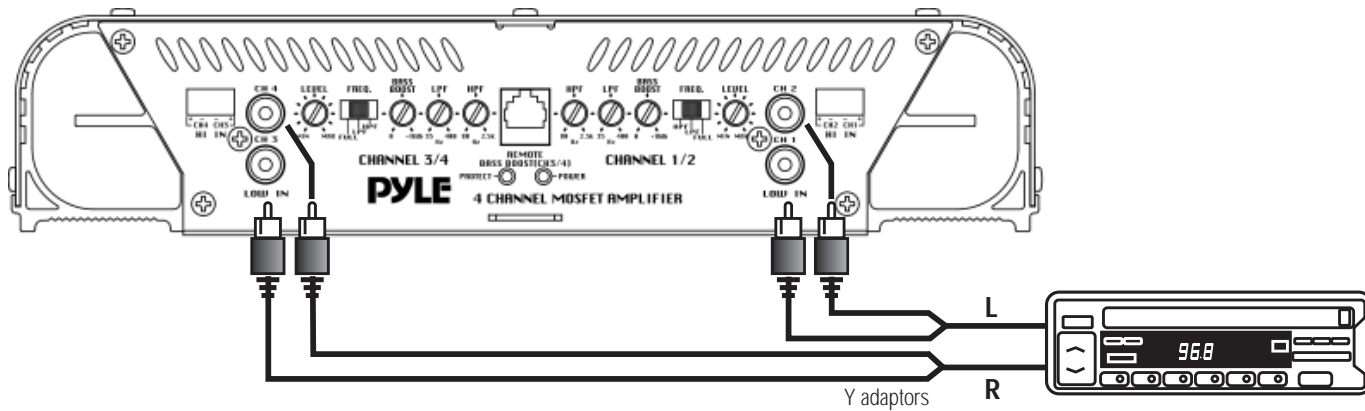

PYLE
GEAR

high level mono input connections

4 ch amp PLA-4150 • PLA-4250 • PLA-4350

4 CH floating ground connections

PLA-4150

PLA-4250

PLA-4350

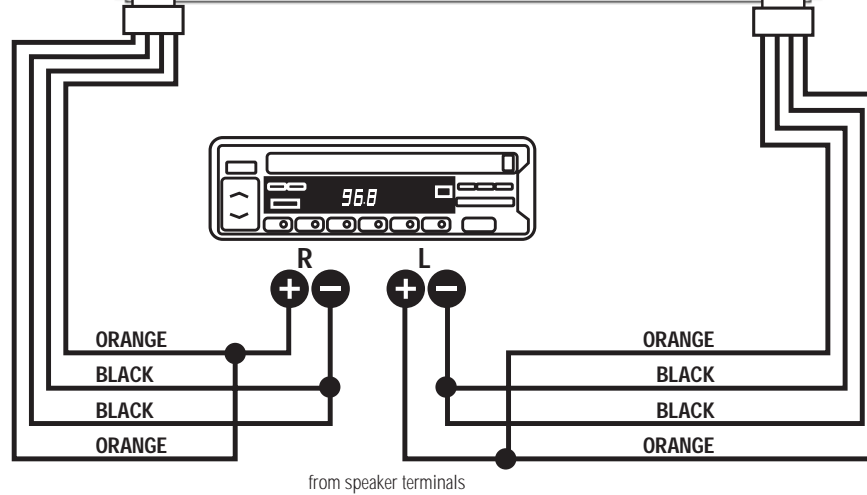
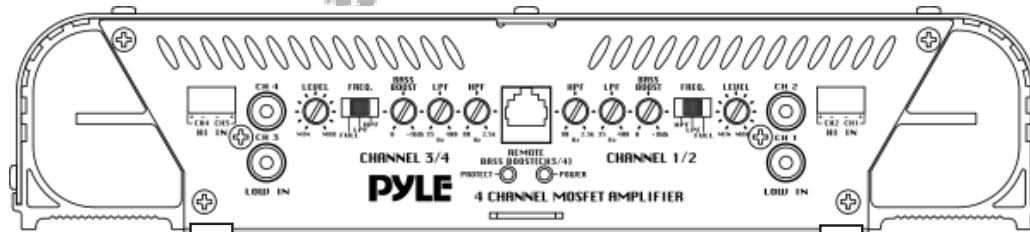

PLEASE NOTE! If using high level inputs, do not use the low level RCA inputs at the same time!

4 CH harness wiring for common ground connections

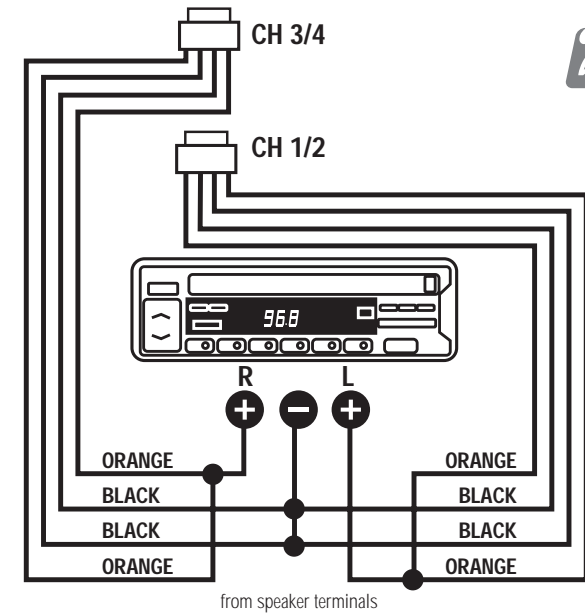

29



system wiring

Class-D MONO BLOCK AMPLIFIER PLA-4300D

PLA-4300D

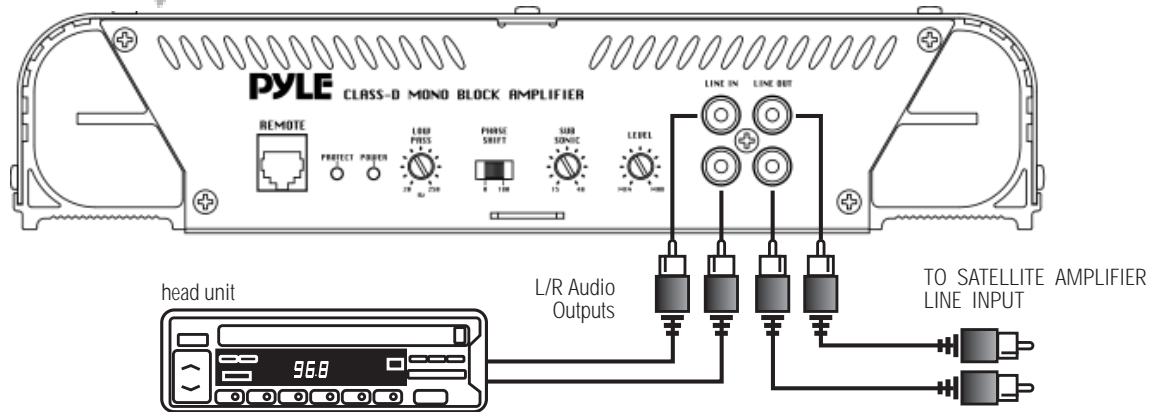

SPEAKER OUTPUT CONNECTION

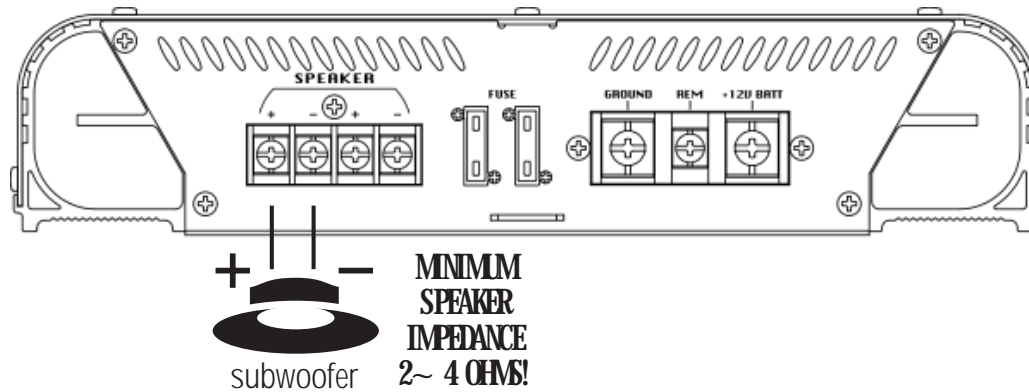



speaker connections

2 ch amp PLA-219 • PLA-2150 • PLA-2250 • PLA-2350
PLA-2450 • PLA-2550 • PLA-2650 • PLA-2750
PLA-2850

Stereo Output Mode

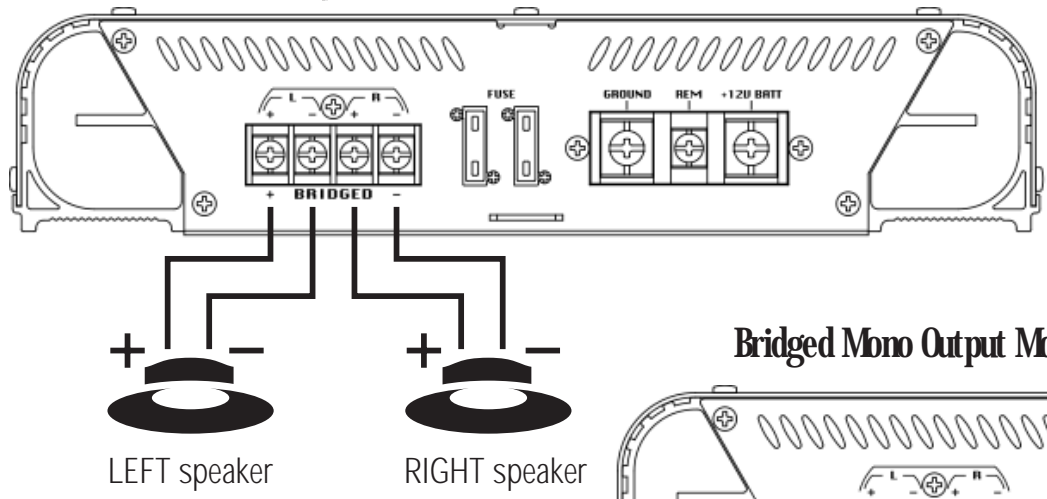

- PLA-219
- PLA-2150
- PLA-2250
- PLA-2350
- PLA-2450
- PLA-2550
- PLA-2650
- PLA-2750
- PLA-2850

Bridged Mono Output Mode (PLA-219 WITHOUT)

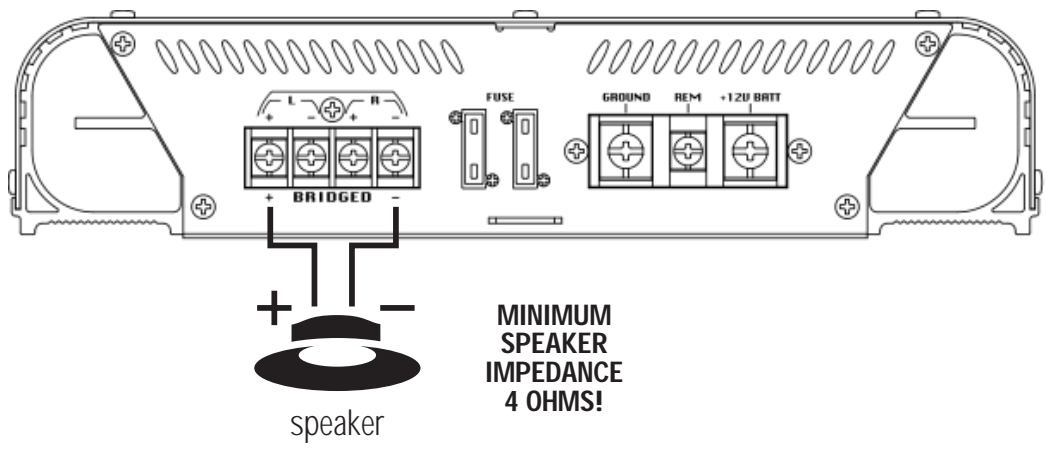



speaker connections

4 ch amp PLA-419 • PLA-4150
 PLA-4250 • PLA-4350

4 CH Output Mode

- PLA-419
- PLA-4150
- PLA-4250
- PLA-4350

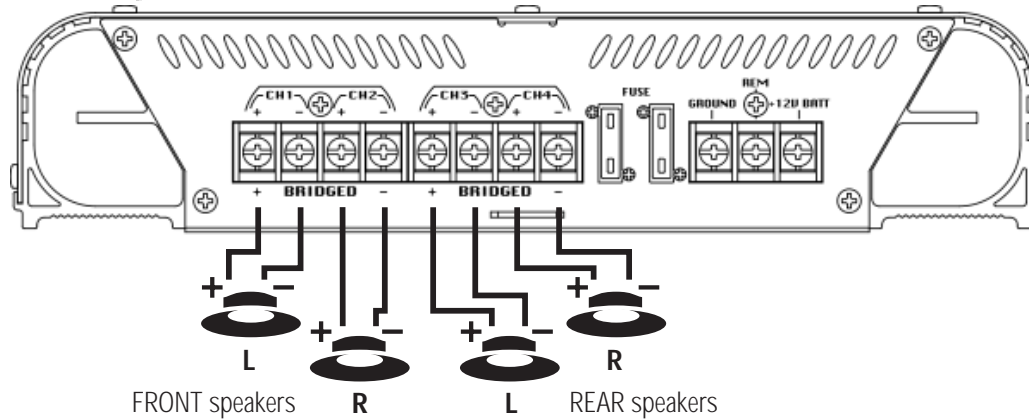

FRONT speakers L R L R REAR speakers

Bridged Dual Mono Output Mode (PLA-419 WITHOUT)

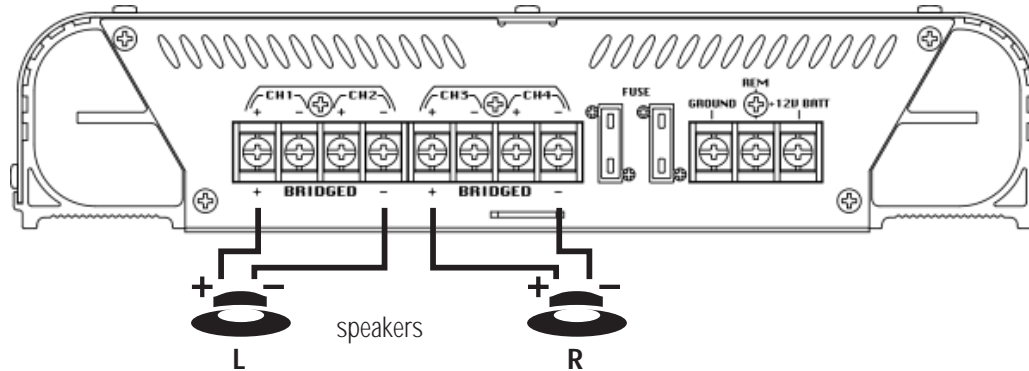

**MINIMUM
 SPEAKER
 IMPEDANCE
 4 OHMS!**



speaker connections

4 ch amp PLA-4150 • PLA-4250 • PLA-4350

pb-836GX
pb-1036GX
PLA-4350

2 CH Bridged Output Mode with Subwoofer Output

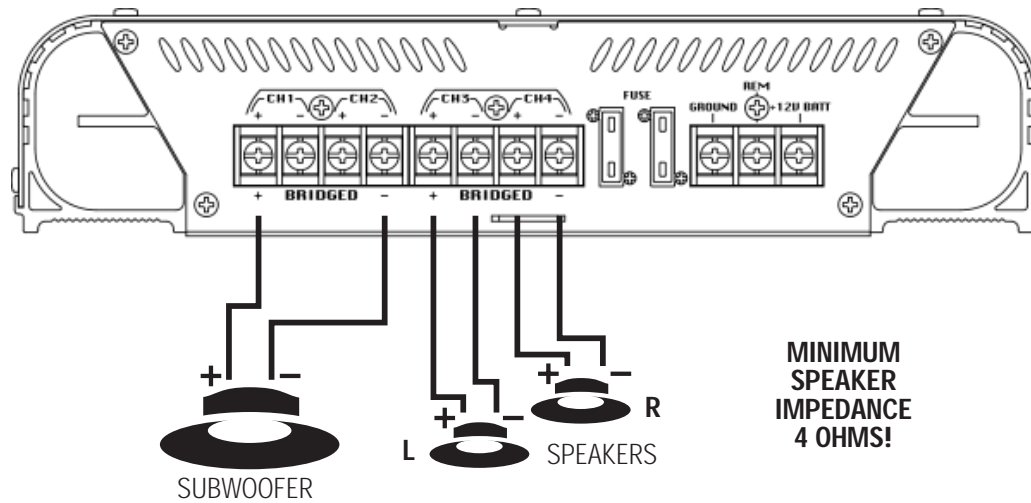



mounting and installation

Your new Pyle GearX Series amplifier comes complete with all required mounting hardware. When determining a suitable location in your vehicle for the amp, please remember that it is a high-power electronic device capable of generating high heat.

For this reason, **always choose a location in your vehicle which has low vibration, adequate ventilation, a minimum of dust, and no moisture.** Be sure to mount the amp in such a manner as to allow reasonable airflow over the cooling fins.

Mark the location for the mounting screw holes by positioning the amp where you wish to install it and use a scribe (or one of the mounting screws) inserted in each of the mounting holes to mark the mounting surface. If the mounting surface is carpeted, measure the hole centers and mark with a felt tip pen.

Before attempting to drill the mounting holes, take note of any wires, lines or other devices in your vehicle which may be located behind the mounting surface! Then drill pilot holes in the mounting surface for the mounting screws and insert them. Tighten the screws securely.

34

wiring tips

When making electrical connections to your amplifier, please observe the following:

Use at least 8 gauge wire for power and ground connections.

Wire the amplifier directly to the car battery.

For the ground connection, use the shortest possible wire to a good chassis ground point.

Wire the Remote connection to the auto start lead of your head unit, equalizer or power antenna.

fuses

About power fuses:

Pyle GearX Series amplifiers feature built-in fuse systems. These fuses protect both the amplifier and the electrical system in your vehicle from fault conditions. If you ever need to replace the fuse in your Pyle GearX Series amp, use a fuse of exactly the same type and rating. A different type or rating of fuse may result in damage or fire.

PYLE® GEAR X

protection circuitry

The built-in protection circuitry in the Pyle GearX Series amplifiers will disable the amplifier if it senses an input overload, a speaker short circuit, or extreme temperature conditions.

When the protection circuit is activated by any of these conditions, the Protection LED will be illuminated.

If this occurs, carefully inspect the system to determine the source of the problem.

- If the shutdown was a result of a thermal overload condition, allow the amplifier to cool down before attempting to restart it.
- If the shutdown was a result of an input overload, or speaker short circuit, be sure to correct the condition before restarting.

The amplifier can be restarted by turning the remote power OFF and then ON again.

troubleshooting

No output.

Confirm that all terminal strip connections are secure and tight.

Check both in-line and built-in fuses. Both the +12V and the Remote terminals must have +12v referenced to chassis ground.

Confirm that the audio signal source (car radio, equalizer, etc.) is connected and is supplying output signal. To check if the amp is supplying signal, unplug the cables from the signal source (but leave them plugged into the amp). Briefly tap the center pin of each of the disconnected RCA plugs with your finger. This should produce a noise (feedback) in your speakers.

Only one channel works.

Confirm that all terminal strip connections are secure and tight.

Check the Balance control on the head unit (or other source) to verify that it is set to its midpoint.

If you are using the Low Level RCA input, reverse the input plugs at the amplifier (i.e., switch the L with the R). If the channels which is silent switches to the other side, the problem is either in the head unit/other source or the connecting cables.

Weak output.

Readjust the Input Level Control(s) to better suit the input signal.

Noise in the audio.

If the noise is a "whine" whose pitch follows the engine speed, confirm that the amplifier and any other signal sources (head unit, etc.) are properly grounded.

If the noise is a "clicking" or "popping" noise whose rate follows the engine speed, this usually means that the vehicle is equipped with resistor spark plugs and wires, or that the ignition is in need of service.

Check the routing of the speaker and input wires to make sure they are not adjacent to wires which interconnect lights and other accessories.

If the above steps fail to improve or clear noise interference, the system should be checked by a professional mobile audio installer.

PYLE® GEAR X

precautions

Do not operate the amplifier when it is unmounted. Attach all audio system components securely within the automobile to prevent damage, especially in an accident.

Do not mount this amplifier so that the wire connections are unprotected, or in a pinched condition, or likely to be damaged by nearby objects.

Before making or breaking power connections in your system, disconnect the vehicle battery. Confirm that your head unit or other equipment is turned off while connecting the input jacks and speaker terminals.

If you need to replace the power fuse, do so only with a fuse identical to that supplied with the amplifier. Using a fuse of a different type or rating may result in damage that isn't covered in the manufacturer's warranty.

notes

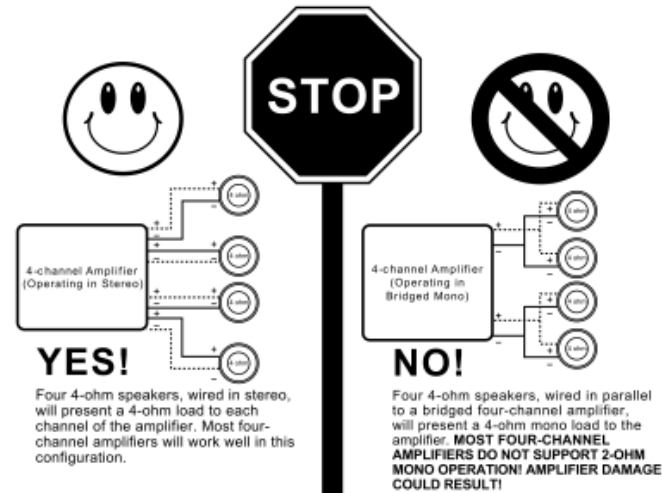
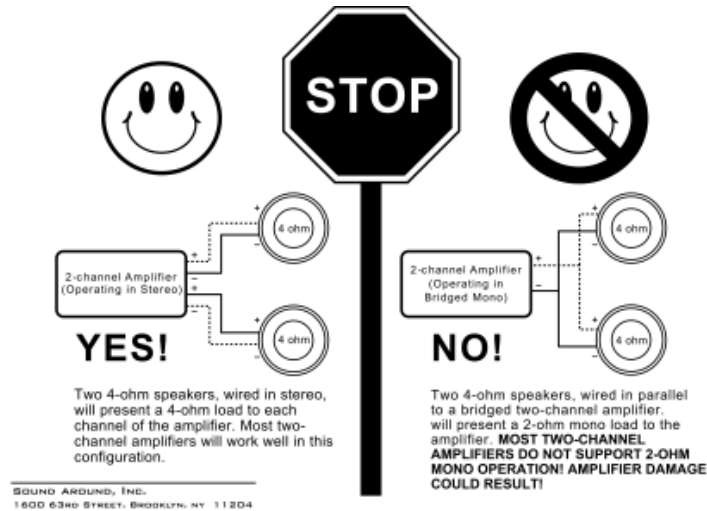



limited warranty policy amplifiers

All Pyle products are carefully constructed and thoroughly tested before shipment. Products purchased in the USA are warranted to be free of defects in material and workmanship for two (2) years from the date of purchase. This warranty is limited to the original retail purchase.

Should the product fail due to factory defects in material or workmanship, your unit will be repaired or replaced at the sole discretion of Pyle.

To obtain warranty service you must first call our Consumer Return Hotline number at (718) 236-6948 to obtain a Return Authorization number. This R.A.# must appear on the outside of your package and on all paperwork relating to your return.

When returning a product to us for warranty service it must be carefully packed and shipped prepaid to:

R.A.#
Pyle Service Center
1600 63rd Street
Brooklyn, NY 11204

You must also include the following items:

- A copy of your sales receipt or other proof of purchase
- A brief letter indicating the problem you are experiencing
- include in your letter your return address, daytime phone number, and R.A. number
- also include a check or money order for \$18.00 for return shipping, handling, and insurance, or provide your Visa/MC number with expiration date.

Our obligation under this warranty is limited to the repair or replacement of the defective unit when it is returned to us prepaid. This warranty will be considered void if the unit was tampered with, improperly serviced, or subject to misuse, neglect, or accidental damage.

www.pyleaudio.com