

Thank you for purchasing the Minolta Vectis 3000. The Vectis 3000 is an easy to operate lens shutter camera from Minolta's line of Advanced Photo System™ cameras. Your camera features Mid-roll Change, Drop-in Loading, a 22 - 66mm zoom lens, and a wide focus frame. The sleek and compact design gives the Vectis 3000 a sophisticated appearance suitable for any occasion. This manual is designed to help you understand the operation of your camera and its functions. Please familiarize yourself with the names of the controls and their locations on the camera, then read this manual thoroughly.

*Advanced Photo System™ is a trademark of the five system developing companies.

Advantages of the Advanced Photo System

New print formats...

Classic C print, wider H print, and panorama P print formats are available with Advanced Photo System cameras.



New feature...

Mid-Roll Change - Rewind your film in the middle of the roll and reload it later, without fear of double exposures.

Easier to load...

Advanced Photo System cameras use the new IX240 type film. This new film features Drop-in Loading to make loading your camera simple, the first time, every time. Indicators on the cassette tell you and your camera if the film is unexposed, partially exposed, exposed, or processed.

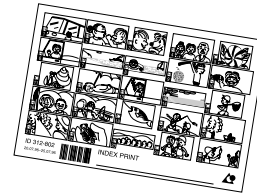
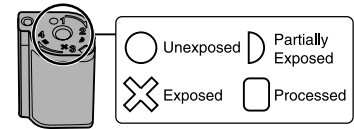

New processing...

In addition to returning your prints in the format you selected, certified photofinishers will return your Advanced Photo System film in its original cassette with an index print. To order reprints, simply choose the images you want from the index print. No more searching through negatives to find the right frame.

TABLE OF CONTENTS

FOR PROPER AND SAFE USE	4
NAMES OF PARTS	6
QUICK OPERATION	10
BASIC OPERATION	
Attaching the Strap	13
Installing the Battery	14
Checking the Battery	15
Loading Film	17
Full-Auto Operation	22
Focus Hold	27
For Closer Subjects	29
Special Focusing Situations	32
Rewinding the Film	33
Processing	38

USING THE BUILT-IN FLASH	
Selecting the Flash Mode	40
Flash Range	41
Red-eye Reduction	42
Fill Flash	43
Flash Cancel	44
Night Portrait	45
Landscape/Night View	46
ADDITIONAL FEATURES	
Date Imprinting	48
Title Imprinting	56
Self-timer	66
Remote Control (Sold Separately)	68
APPENDIX	
Lab Services	74
Caring For Your Camera	76
Technical Details	82

FOR PROPER AND SAFE USE

Read and understand all warnings and cautions before using this product.

WARNING

Batteries may become hot or explode due to improper use.

- Use only the batteries specified in this instruction manual.
- Do not install the batteries with the polarity (+/-) reversed.
- Do not subject batteries to fire or high temperatures.
- Do not attempt to recharge, short, or disassemble.
- Tape over lithium battery contacts to avoid short-circuit when disposing of batteries, and follow local regulations for battery disposal.

Keep batteries or things that could be swallowed away from young children. Contact a doctor immediately if an object is swallowed.

4

Immediately remove the batteries and discontinue use if...

- the product is dropped or subjected to an impact in which the interior is exposed.
- the product emits a strange smell, heat, or smoke.

Do not disassemble. Electric shock may occur if a high voltage circuit inside the product is touched. Take your camera to a Minolta Service Facility when repairs are required.

CAUTION

The lens retracts when the camera is turned off or Auto Power Off is activated. Touching the lens barrel while it is retracting may cause injury.

5

NAMES OF PARTS

CAMERA BODY

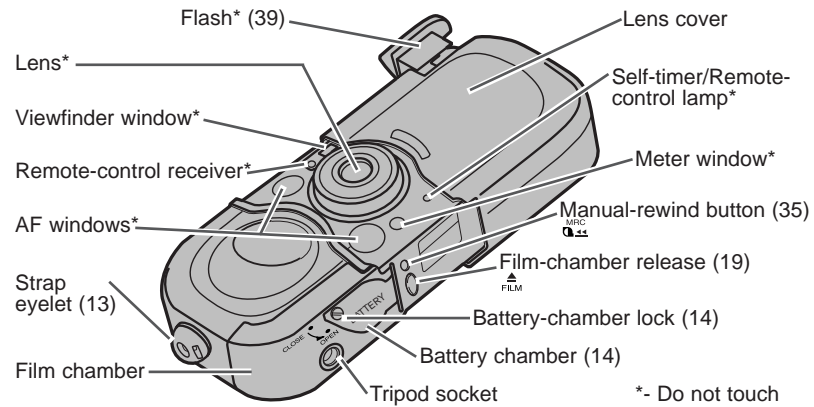

6

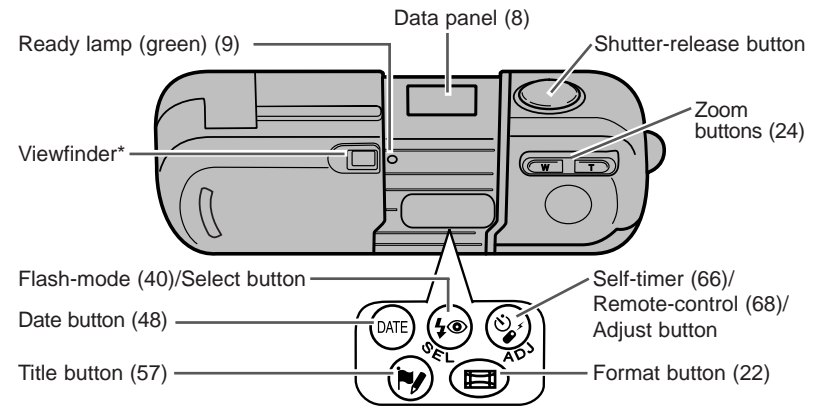

For information on specific parts, refer to the page numbers shown in parenthesis.

7

NAMES OF PARTS

DATA PANEL

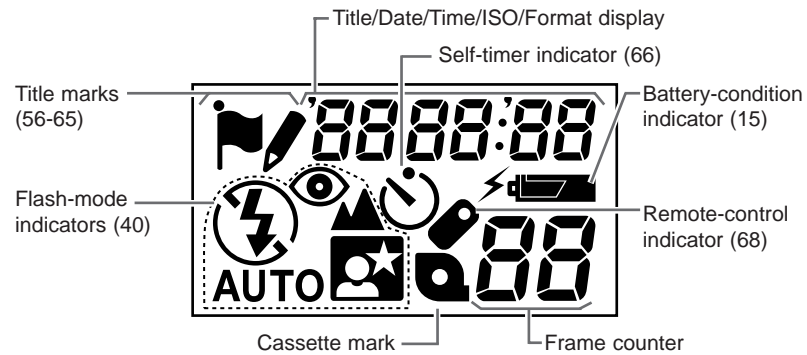

- Only the necessary indicators will appear in the data panel.

VIEWFINDER

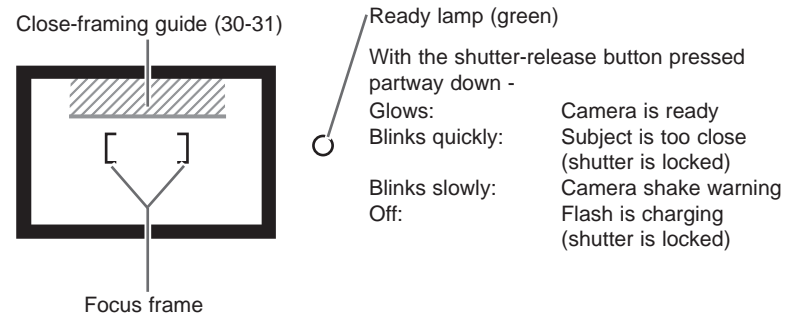

QUICK OPERATION

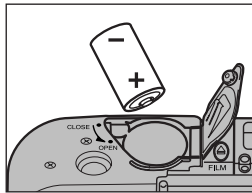

1. Insert the battery (p. 14).

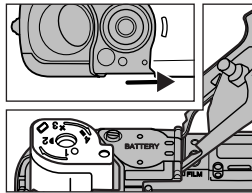

2. Open the lens cover to turn the camera on, then insert the film (p. 18).

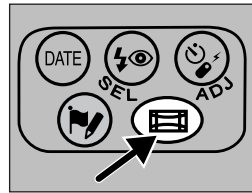

3. Select the print format (p. 22).

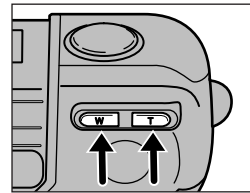

4. Frame the subject as desired (p. 24).



5. Center your subject in the focus frame (p. 24).

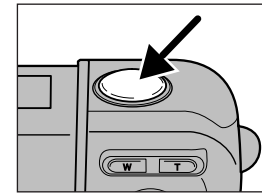

6. Press the shutter-release button all-the-way down to take the picture (p. 25).

BASIC OPERATION

12

ATTACHING THE STRAP

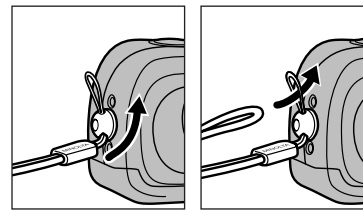

Attach the strap as shown.

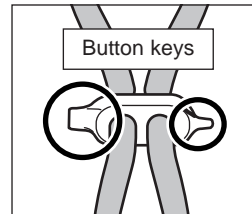

- Button keys are included on the strap. Use the bigger key to turn the battery-chamber lock (p. 14), smaller key to push the manual-rewind button (p. 35).

13

INSTALLING THE BATTERY

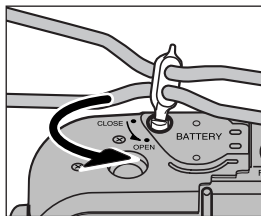

Your camera uses one 3-volt CR-2 lithium battery to supply power for all camera operations.

1. Turn the camera upside down, then open the battery chamber as shown, using the bigger button key on the strap.

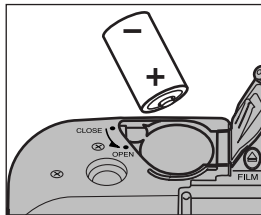

2. Insert the battery into the chamber as indicated by the + and - marks.

3. Close the battery chamber, then turn the lock until it stops at CLOSE.

- After installing a new battery, reset the date and time (p. 50).

CHECKING THE BATTERY

Each time the lens cover is opened, a symbol will appear in the data panel to indicate the power status of the battery.

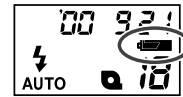

Briefly appears. Power is sufficient for all camera operations.

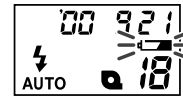

Power is sufficient, but the battery must be replaced soon.

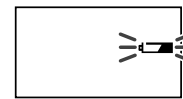

Replace the battery. The shutter will lock until the battery is replaced.

Continued on following page.

CHECKING THE BATTERY

- If no display appears, replace the battery or check that it is inserted correctly.
- Auto Power Off: The data panel will shut off and the lens will retract if the camera is not operated for more than eight minutes. Press the shutter-release button partway down, or press either zoom button to resume operation.
- Do not obstruct the lens while it is retracting.

LOADING FILM

Your camera uses IX240 type film designed for use in Advanced Photo System cameras.

- Your camera's automatic transport system loads the film, sets the film speed, and advances the film after each exposure.
- Use film from ISO25-3200. Your camera will automatically set the proper ISO.
- After loading, the film chamber cannot be opened until the film has been rewound.
- There is no need to worry about double exposure. DEP, Double Exposure Prevention, prevents the camera from accepting exposed film.

Continued on following page.

LOADING FILM



Visual Exposure Indicators

- The current VEI has a white indicator behind it.
- This camera can load film with the ● or ▸VEI current.
- **Only partially-exposed (VEI ▸) film rewound in a Minolta camera with Mid-roll Change can be loaded in this camera.**

VEI	MEANING
●	UNEXPOSED
▸	PARTIALLY EXPOSED
×	EXPOSED
■	PROCESSED

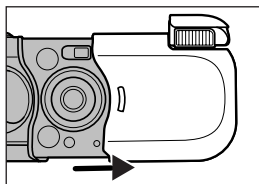

1. Open the lens cover to turn the camera on.

- The built-in flash pops up, the lens extends slightly, then retracts to the original position.

18

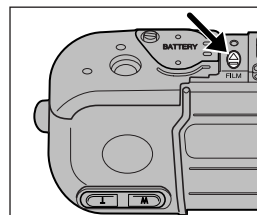

2. Turn the camera upside down, then press the film-chamber release. The film-chamber door will open partway.

- **OPEN** will appear and ■ will blink in the data panel.

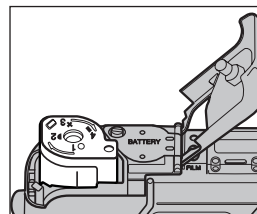

3. Insert the cassette into the film chamber with the VEI on top.

- Do not use force when opening the film-chamber door.

Continued on following page.

19

LOADING FILM

4. Press the film-chamber door closed until it clicks.

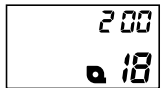
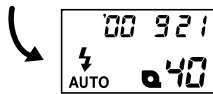
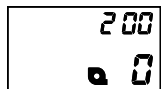

- The data panel will display the cassette mark and the film's ISO, then the number of frames remaining on the roll.
- If a partially-exposed roll of film (VEI **▶**) is loaded into this camera, the film will be advanced to the first unexposed frame.
- After the film is loaded, pressing the film-chamber release will display the film's ISO in the data panel. The display will disappear about 2 seconds after the finger is released. The film chamber cannot be opened until the film has been rewound.



If 0 blinks in the data panel, press the film-chamber release, open the chamber, then remove the film.

- If the film's current VEI is **✕**, insert film with the **●** or **▶** VEI current.
- If a processed roll of film was loaded into this camera, the VEI has been changed from **■** to **✕**.
- If the film's current VEI is **●** or **▶**, remove the film, remove and reinsert the battery, then reload the film. If the film will not load, contact the nearest authorized Minolta Service Facility.

FULL-AUTO OPERATION

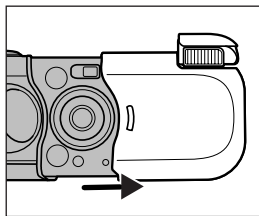

1. Open the lens cover to turn the camera on.

- The camera is set for fully-automatic operation and the flash will fire automatically when necessary.
- The print format is set to C, H, or P, whichever was selected last.

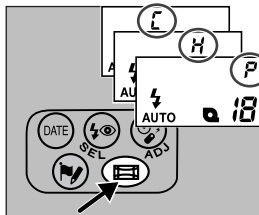

2. Press the format button to select the print format.

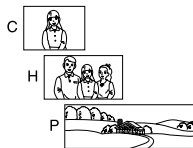

22

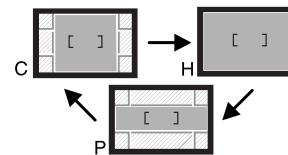

- The viewfinder will change to match your selection. The area shown by  will be on the final print.

Hold the camera steady, making sure your fingers do not cover the flash, AF windows, or meter window. If you are taking a vertically framed picture, turn the camera so the flash is on top.

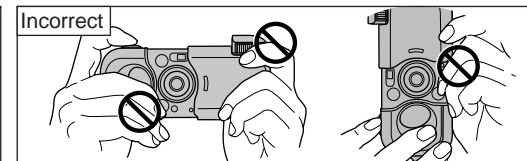
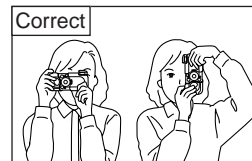

Continued on following page.

23

FULL-AUTO OPERATION

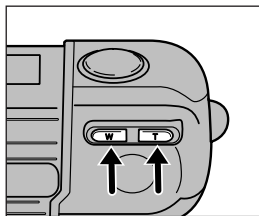

3. Looking through the viewfinder, frame the subject as desired.

**Press the W zoom button to zoom out.
Press the T zoom button to zoom in.**

- Do not hold or obstruct the lens barrel.



4. Center your subject in the focus frame, then press the shutter-release button partway down.

- If the close-framing guide appears in the viewfinder, move the camera slightly upward without lifting your finger (pp. 30-31).

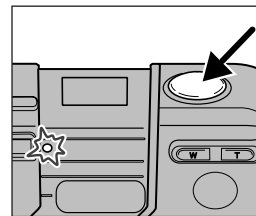

5. When the green ready lamp glows, press the shutter-release button all-the-way down to take the picture.

- If the ready lamp does not glow, the flash is not charged. Wait until it glows, then take the picture.
- If the ready lamp blinks quickly and the shutter is locked, your subject is too close (p. 29).
- Press the shutter-release button with a slow steady squeeze - never a quick jab.

After use, close the lens cover to turn the camera off.

- If the lens is extended, follow the instruction on the next page to close the lens cover.

Continued on following page.

FULL-AUTO OPERATION

CLOSING THE LENS COVER

The lens is extended unless the zoom position is at the wide end. When the lens is extended, close the lens cover following the instructions below. Do not slide the lens cover with one movement.

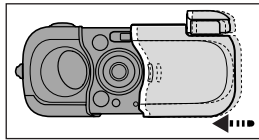

1. Slide the lens cover slightly until it clicks into place.

- The lens will retract.

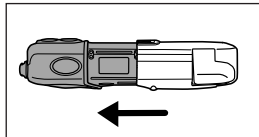
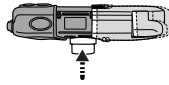

2. When the lens has retracted completely, shut the lens cover.

FOCUS HOLD



Subjects outside the focus frame may not be in focus. Use focus hold to ensure accurate focusing.



1. Center your subject in the focus frame.

Continued on following page.

FOCUS HOLD



2. Press and hold the shutter-release button partway down so the green ready lamp glows.



3. Without lifting your finger, recompose the picture and press the shutter-release button all-the-way down to take the picture.



- Lift your finger from the shutter-release button to cancel focus hold.

FOR CLOSER SUBJECTS

The minimum focus distance of this camera is 40cm (1.3 ft.) when the print format is C or H.



The green ready lamp will blink rapidly and the shutter will lock when you are closer than the minimum focus distance.

- When the print format is P, the minimum focus distance changes with the focal length; 47cm (1.5 ft.) at W (22mm), 1.1m (3.6 ft.) at T (66mm), and middle distance for middle focal length position.
- If the subject is very close, the ready lamp may glow or blink slowly and the shutter may be released, but the picture will not be in focus.

Continued on following page.

FOR CLOSER SUBJECTS

CLOSE-FRAMING GUIDE (FOR C AND H FORMATS)

If your subject is farther than the minimum focus distance but close enough to cause parallax, the actual image and the image seen through the viewfinder do not match. In this case, the close-framing guide appears in the viewfinder when you press the shutter-release button partway down. Follow the instructions in the next page to take the picture.

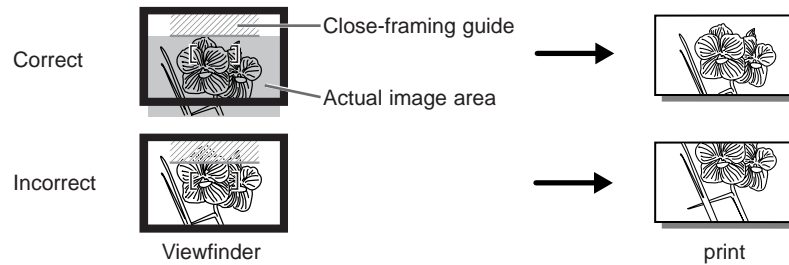

30



1. Center your subject in the focus frame, then press the shutter-release button partway down.

- The close-framing guide will appear.



2. Without lifting your finger, move the camera slightly upward.

3. Press the shutter-release button all the way down to take the picture.



31

SPECIAL FOCUSING SITUATIONS

Some scenes or subjects, like the examples below, are difficult for the autofocus system to lock on to. In these shooting situations, focus hold (p.27) on another object with the same brightness and the same distance from you as your main subject, recompose, then press the shutter-release button all-the-way down to take the picture.

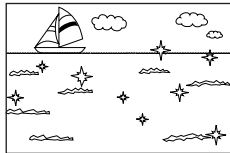

- Bright light sources such as the sun or neon lights
- Highly reflective surfaces such as water, mirrors, etc.
- Flame, fireworks, etc.
- Dark objects and surfaces with low reflectance

- Objects behind glass, bars, or other such as partitions



REWINDING THE FILM

Your camera automatically rewinds the film into the cassette after the last exposure.



1. Wait for the film to completely rewind into the cassette.

- If the lens is extended, it will retract before rewind.
- The frame counter will count down during rewind.
- 0 will appear in the frame counter and  will blink when rewind is complete.

Continued on following page.

REWINDING THE FILM

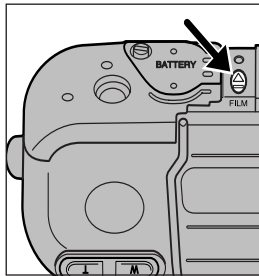

2. Turn the camera upside-down, then press the film-chamber release to open the film chamber.

3. Open the film chamber and remove the film.
- *OPEn* will appear and  will blink in the data panel.
 - The film's VEI indicator will be **X**.

MANUAL REWIND

Use manual rewind to rewind the film before the roll is finished.

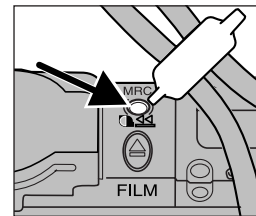

1. Gently press the manual-rewind button using the smaller button key on the strap.

2. Follow steps 1- 3 from automatic rewind.
- The film's VEI indicator will be **▶**.

Continued on following page.

REWINDING THE FILM

MID-ROLL CHANGE (MRC)

Your camera has the MRC feature, which allows film to be rewound in the middle of a roll and reloaded at a later time. When reloaded, the camera will advance the film to the first unexposed frame. Film can be rewound and reloaded until the last frame is taken, when the camera automatically rewinds the film and sets the VEI to **✕**.

- Cameras without the MRC feature set the VEI for partially-exposed rolls to **✕**. Cassettes with the **✕** VEI current can not be reloaded.

Only partially-exposed film rewound in a Minolta camera with Mid-roll Change capability can be reloaded into this camera. Film rewound in another manufacturer's MRC capable camera may not function properly.

- The MRC feature may not work properly when loading a partially exposed roll of film (VEI **▶**) in the following situations; near a strong electromagnetic field generator such as a speaker, PC monitor or mobile phone. Insert the film at least 1m (3.3 ft.) away from these places.

PROCESSING









For best results, take your film to a Certified Advanced Photo System photofinisher displaying this symbol (p. 74).

USING THE BUILT-IN FLASH

When you open the lens cover to turn the camera on, the built-in flash is set to Autoflash or Autoflash with red-eye reduction. The flash will fire automatically when necessary.

SELECTING THE FLASH MODE

Autoflash mode , Autoflash with red-eye reduction , Fill-flash , Flash cancel , Night Portrait , or Landscape/Night View  can be selected.

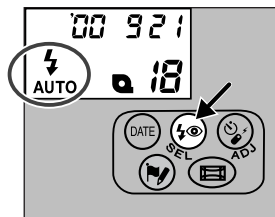

Press the flash-mode button until the desired indicator appears in the data panel.

- Flash modes remain selected after the picture is taken.

FLASH RANGE

The range of the built-in flash depends on the film speed and the focal length you are using. To ensure proper exposure, make sure your subject is positioned within the flash range.

Focal length Film speed	Wide 22mm	Tele 66mm
ISO 100	0.4 – 2.5m (1.3 – 8.2 ft.)	0.4 – 1.5m (1.3 – 4.9 ft.)
ISO 200	0.4 – 3.6m (1.3 – 11.8 ft.)	0.4 – 2.2m (1.3 – 7.2 ft.)
ISO 400	0.4 – 5.0m (1.3 – 16.4 ft.)	0.4 – 3.1m (1.3 – 10.2 ft.)

RED-EYE REDUCTION

Use the built-in flash's red-eye reduction mode to reduce the red-eye effect when photographing people or animals at night or in low light situations. The flash will fire a few short bursts before the main flash burst to reduce the red-eye effect.

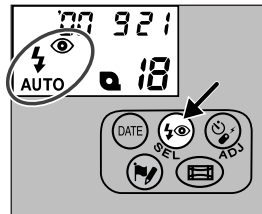

Press the flash-mode button until  appears in the data panel.

- Warn your subject that the flash will fire a few short bursts just before the picture is taken.
- The flash mode will remain selected after you turn the camera off.

FILL FLASH

The flash will fire when the shutter is released regardless of lighting. Use fill flash to reduce harsh shadows on your subject's face.

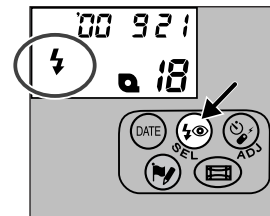

Press the flash-mode button until  appears in the data panel.

- When you turn the camera off, the flash mode will be reset to Autoflash or Autoflash with red-eye reduction, whichever mode was used last.

FLASH CANCEL

The flash will not fire in this mode. Use flash cancel when you want to photograph subjects that are beyond the flash range or to capture the ambiance of existing light.

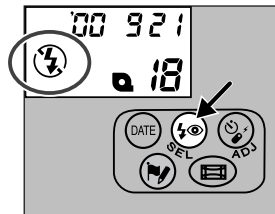

Press the flash-mode button until  appears in the data panel.

- Shutter speeds may be slow in this mode. Use of a tripod is recommended.
- When you turn the camera off, the flash mode will be reset to Autoflash or Autoflash with red-eye reduction, whichever mode was used last.

NIGHT PORTRAIT

In this mode, the camera balances the flash and existing light exposure so you can take beautiful pictures of people at sunset or at night. The flash is set to fill flash with red-eye reduction.

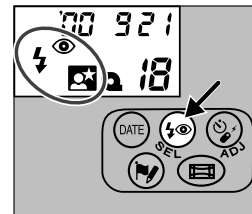

Press the flash-mode button until  appears in the data panel.

- The shutter speed may be slow. Use of a tripod is recommended.
- When you turn the camera off, the flash mode will be reset to Autoflash or Autoflash with red-eye reduction, whichever mode was used last.

LANDSCAPE/NIGHT VIEW

The flash will not fire in this mode and the focus is set to infinity. It can be used to photograph night scenes, ensure sharp focus for landscapes and other distant subjects, and should be used when photographing through glass.

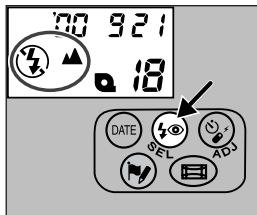

Press the flash-mode button until  appears in the data panel.

- The shutter speed may be slow. Use of a tripod is recommended.
- When you turn the camera off, the flash mode will be reset to Autoflash or Autoflash with red-eye reduction, whichever mode was used last.

ADDITIONAL FEATURES

DATE IMPRINTING - Setting the Date and Time

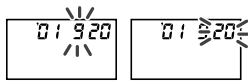

4. Repeat the step 3 until all items in the date and time display are correct.

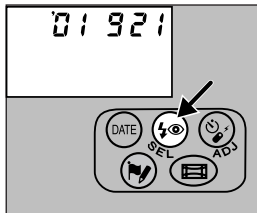

5. Press the select button until all items stop blinking to set the updated information.

- The data panel shows the date display briefly, then the camera exits the set date/time mode. The data panel will show the imprinting option (date, time, or no imprinting) that was selected before going to set date/time mode.

DATE IMPRINTING - Changing the Format

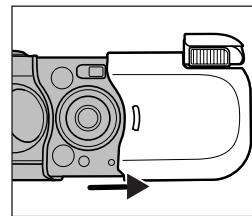

The order of year/month/day can be changed.

1. Open the lens cover to turn the camera on.

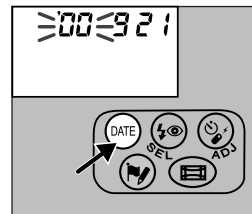

2. Press and hold the date button for two seconds.

- The date display will appear in the data panel, and the year will blink.

Continued on following page.

DATE IMPRINTING - Changing the Format

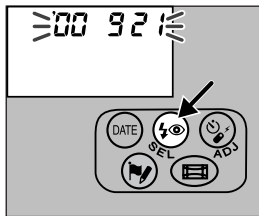

3. Press and hold the select button for two seconds.

- All items in the date display blink.

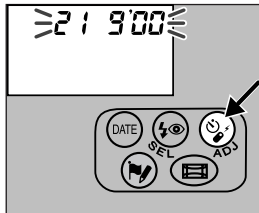

4. Press the adjust button to change the display format.

- The format sequences as follows:

00 921 → 92100 → 21 900
Y/M/D M/D/Y D/M/Y

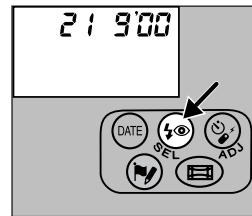

5. Press the select button to set the updated information.

- The data panel shows the updated format for five seconds, then the camera exits the change format mode. The data panel will show the imprinting option (date, time, or no imprinting) that was selected before going to the change format mode.
- Pressing the select button during the five seconds will make the year blink for setting the date and time (p. 50).
- The format will remain after replacing the battery.

TITLE IMPRINTING

Three titles from the title list can be preset for use while taking pictures. Any one of the three preselected titles can be selected before the picture is taken (User Select Title Imprinting). When selected, the title will be recorded on the film's magnetic data strip. At certified Advanced Photo System labs, the selected title will be printed on the back of the print. See your photofinisher for details. Some labs may not be able to print the titles in all of the available languages.

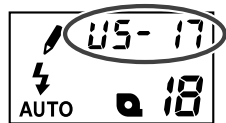

Titles are displayed in the data panel as a title code. Please refer to the Title List sheet for the titles available with this camera. When / appears in the data panel, the title will be recorded on the print.

TITLE IMPRINTING - Preselecting Titles

Three title codes have been set into memory. You can change one or all three title codes at any time.

1. Open the lens cover to turn the camera on.
2. Select the code for the title you want from the title list.
3. Press the title button to display the title code you want to change.

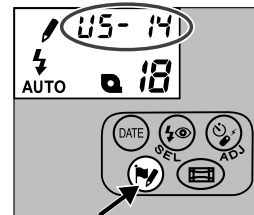

Continued on following page.

TITLE IMPRINTING - Preselecting Titles

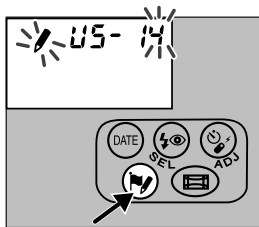

4. Press and hold the title button for two seconds.

- The last digit of the title code number will blink.

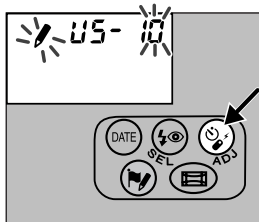

5. Press the adjust button to change its value.

- Press and hold the adjust button to change the value rapidly.

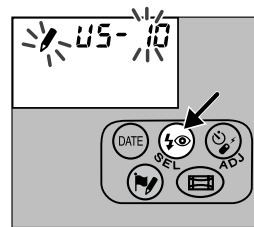

6. Press the select button to make the next digit blink, change its value using the adjust button.

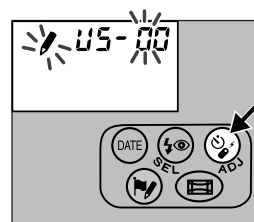

Continued on following page.

TITLE IMPRINTING - Preselecting Titles

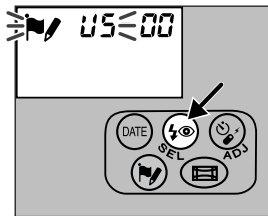

7. Press the select button to make the language code blink.

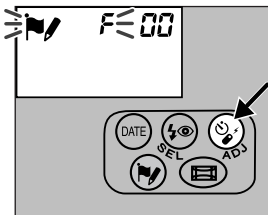

8. Press the adjust button to change the language code.

60

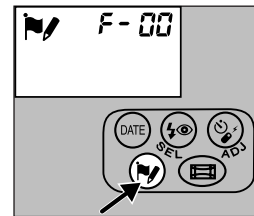

9. When the title information is correct, press the title button.

- The data panel shows the updated title briefly, then the camera exits the title mode.
- The updated title will be recorded on the print if you press the shutter-release button.

61

TITLE IMPRINTING - Frame Title

You can select the title to imprint for each frame before taking the picture.

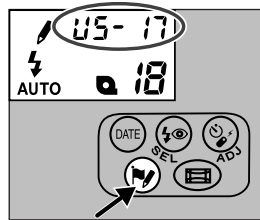

Before taking the picture:

1. Press the title button to display the code for the title you want.

- Each press of the title button changes the title code to the next selection.

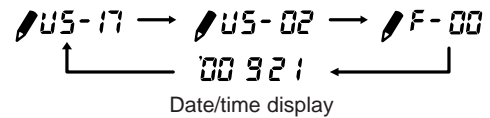

Date/time display



- Pressing any other button replaces the title code with date/time display.

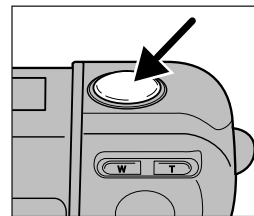

2. Take the picture. The magnetic data is written and the selection is cancelled for the next frame.

TITLE IMPRINTING - Filmstrip Title

An additional title for the entire roll of film can be selected. Both the filmstrip title and the frame title will be printed on the back of the print.

- Filmstrip titles set on rolls rewound at mid roll will appear on frames exposed after reloading.
- A filmstrip title can not be set on a reloaded partially exposed roll.
- Once a filmstrip title is set, it can not be changed or cancelled using the camera.

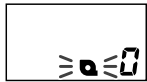

After the film has been rewound and **Q** blinks in the data panel:



1. Press the title button to display the desired filmstrip title.

64

- Each press of the title button changes the title code to the next selection.

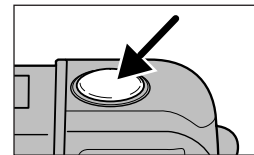
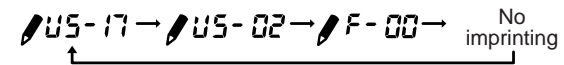

2. Press the shutter-release button **all-the-way down to set the title.**

- The camera advances to write the data on the film's leader, then rewinds the film.



3. When **Q** blinks in the data panel again, press the film-chamber release and remove the film.

- Set the filmstrip title before removing the film.

65

SELF-TIMER

The self-timer delays release of the shutter for approximately 10 seconds after you press the shutter-release button.

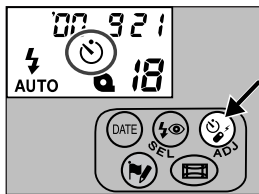

1. Place the camera on a tripod, then press the self-timer button until  appears in the data panel.



2. Center your subject in the focus frame.

- Use Focus Hold for off-center subjects (p. 27).

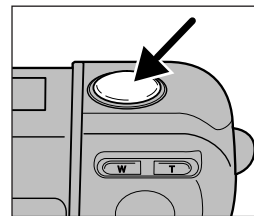

3. Press the shutter-release button all-the-way down.

-  will blink in the data panel during countdown.
- The self-timer lamp will blink slowly. Just before the shutter is released, the self-timer lamp will blink rapidly, then glow.
- To cancel the self-timer, press the self-timer button or close the lens cover to turn the camera off.
- The self-timer is automatically cancelled after the shutter releases.
- Do not press the shutter-release button while standing in front of the camera.

REMOTE CONTROL (Sold Separately)

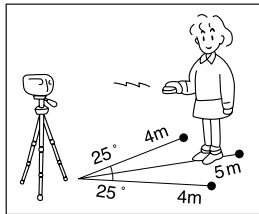

The IR Remote Control RC-3 (not included) allows remote camera operation from up to 5m (16 ft.) away.

- The distance may be shorter or the remote control may not operate with backlit subjects, under fluorescent light, or in extremely bright lighting conditions.

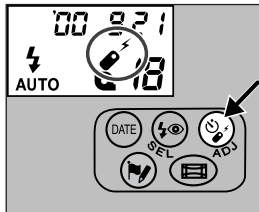

1. Place the camera on a tripod, then press the remote-control button until  appears in the data panel.

2. Compose your picture.

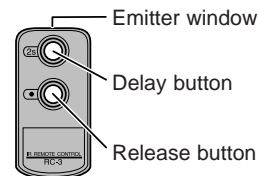

3. Point the remote control with its emitter window toward the front of the camera and press  or 2s button.

- Release (): the remote-control lamp will blink once, and the picture is taken immediately.
- Delay (2s): the remote-control lamp will blink for two seconds before the picture is taken.
- Remote control mode will remain selected after the picture is taken.
- To save power, the data panel will shut off and the lens will retract if the remote control is not operated for more than eight minutes.

REMOTE CONTROL (Sold Separately)

FOCUS HOLD IN REMOTE CONTROL MODE

1. Set the camera to remote control mode.

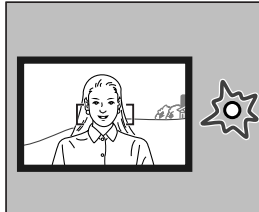

2. Center your subject in the focus frame, then press the shutter-release button partway down so the green ready lamp glows.

- Focus is locked.
- Focus will be reset if you press the shutter-release button partway down again.



3. Lift your finger from the shutter-release button, then recompose the picture.

4. Point the remote toward the front of the camera and press **•** or **2s**.

- The green ready lamp keeps glowing and the focus will remain locked after taking a picture.
- Reset the remote-control or press the zoom button to cancel focus hold.

REMOTE CONTROL (Sold Separately)

CHANGING THE BATTERY

The remote control uses a 3V lithium battery (CR2032). When pressing the remote-control buttons does not release the shutter, the battery must be replaced. (A fresh battery should be sufficient for approximately ten years of operation.)

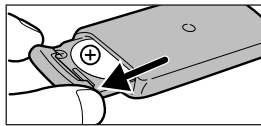

1. Pull out the battery chamber and remove the old battery.

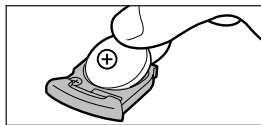

2. Insert a new battery into the battery chamber with its plus side up.
3. Slide the battery chamber back into the remote control.

APPENDIX

LAB SERVICES



To receive the best possible prints, take your film to a photolab displaying the Certified Advanced Photo System logo. Photofinishers displaying this logo have been certified according to Advanced Photo System guidelines.

Certified photolabs will be able to provide the following five services.

1. CHP - Print Format

Your film will be printed according to the format set when the picture was taken.

2. Date and Title Imprinting

The date, time, and selected title are printed on the back of the picture in the chosen format.

3. PQI - Print Quality Improvement

The lab will compensate (or not compensate) printing according to the data recorded on the magnetic data strips.

4. Film is returned in the cassette.

To keep the film dust free and aid in organization, film is returned in its original film cassette. The VEI will be set to  to prevent accidental loading.

5. Index Print

An index print showing a numbered image of each frame is included with your returned order.

Reprints

Images are always captured in the H format (High-Vision). You can select any of the three formats when ordering reprints.

CARING FOR YOUR CAMERA

OPERATING TEMPERATURE AND CONDITIONS

- This camera is designed for use from -10 to 40 °C (14 to 104 °F).
- Never leave your camera where it may be subjected to extreme temperatures such as in the glove compartment of a car.
- At colder temperatures, the data panel response time will be slow. At higher temperatures, the display will temporarily darken, but will restore when the temperature normalizes.
- Never subject the camera to extreme humidity.



- To prevent condensation from forming, place the camera in a sealed plastic bag when bringing it from the cold environment into a warm environment. Allow it to come to room temperature before removing it from the bag.
- When photographing in cold weather, it is recommended that you keep the camera and spare batteries inside your coat to keep them warm when you are not shooting. Cold batteries will regain some of their charge when they warm up.
- This camera is not water proof, dust-proof, or sand-proof; take care when using it at the beach or near water. Costly or irreparable damage may occur.

CARING FOR YOUR CAMERA

CLEANING

- Keep the AF and Meter windows clean or the focus and/or exposure may not be accurate.
- If the camera body is dirty, gently wipe it clean with a soft, clean, dry cloth.
- To clean the lens surface, first brush away any dust or sand then, if necessary, moisten a lens tissue with lens cleaning fluid and gently wipe the lens in a circular motion, starting from the center.
- Never place lens fluid directly on the lens.
- Never touch the lens surface with your fingers.
- Never use alcohol or solvents to clean the camera.

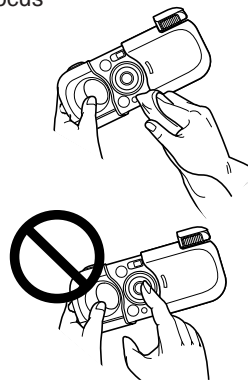

STORAGE

When storing the camera for extended periods, please follow these guidelines:

- Store the camera in a cool, dry, well-ventilated area away from dust and chemicals. For very long periods, place the camera in an airtight container with a silica gel drying agent.
- Before using after prolonged storage, always check the camera's operation to make sure it is functioning properly.

Continued on following page.

CARING FOR YOUR CAMERA

QUESTIONS AND SERVICE

- If you have questions about your camera, contact your local camera dealer or write to the Minolta distributor in your area.
- If the camera is damaged or the rewind motor does not operate, do not open the film chamber or forcefully remove the cassette. Contact an authorized Minolta Service Facility.
- Before shipping your camera for repair, please contact an authorized Minolta Service Facility for details.

BEFORE IMPORTANT EVENTS

- Check camera operation carefully or take test photographs.
- Minolta is not responsible for any loss which may occur due to an equipment malfunction.

FILM CASSETTE WARNING

The film used in Advanced Photo System cameras stores some data magnetically. Do not place the cassette on or near anything that creates a magnetic field, such as a television or stereo speakers.

CAMERA ERROR

If all the indicators in the data panel blink or the data panel is blank and the camera will not function with a fresh battery, remove and reinsert the battery. If normal operation does not resume or the camera malfunctions repeatedly, contact an authorized Minolta Service Facility.

TECHNICAL DETAILS

Camera Type:	IX240 Lens Shutter Camera
Lens:	22 - 66mm f/5.9 - 9.3 lens (approx. equivalent to 27.5 - 82.5mm in 35mm format)
Metering:	Dual-segment metering Range (ISO 200): EV 4 - 17
Shutter Speed:	8 - 1/500 s
Film Speed:	Setting: automatic setting for DX-coded film. Non-DX coded film set to ISO 100. Range: ISO 25 - 3200
Viewfinder:	Magnification: 0.32X - 0.88X Diopter: -1 diopter Field of view (H format): 86% (for subject at 3m)

Flash:	Recycling time: approx. 0.6 - 0.7 s
Battery:	One CR-2 3V lithium battery Battery performance: approx. 10 rolls (Based on Minolta's standard test method using 25 exposure rolls with the flash for 50% of the exposures)
Dimensions:	102 x 58 x 29.5 mm (4.0 x 2.3 x 1.2 in.)
Weight:	160g (5.6 oz.) without battery

Specifications are based on the latest information available at the time of printing and are subject to change without notice.

This device complies with Part 15 of the FCC Rules. Operation is subject to the following two conditions: (1) This device may not cause harmful interference, and (2) this device must accept any interference received, including interference that may cause undesired operation. Changes or modifications not approved by the party responsible for compliance could void the user's authority to operate the equipment. This equipment has been tested and found to comply with the limits for a Class B digital device, pursuant to Part 15 of the FCC Rules. These limits are designed to provide reasonable protection against harmful interference in a residential installation. This equipment generates, uses and can radiate radio frequency energy and, if not installed and used in accordance with the instructions, may cause harmful interference to radio communications. However, there is no guarantee that interference will not occur in a particular installation. If this equipment does cause harmful interference to radio or television reception, which can be determined by turning the equipment off and on, the user is encouraged to try to correct the interference by one or more of the following measures:

- Reorient or relocate the receiving antenna.

- Increase the separation between the equipment and the receiver.
- Connect the equipment to an outlet on a circuit different from that to which the receiver is connected.
- Consult the dealer or an experienced radio/TV technician for help.

This Class B digital apparatus complies with Canadian ICES-003.



This mark on the bottom of your camera is there to inform you that this camera meets the requirements of the EU (European Union) concerning interference causing equipment regulations. CE stands for Conformité Européenne (European Conformity).

Minolta Co., Ltd.

Minolta Europe GmbH
Minolta France S.A.
Minolta (UK) Limited
Minolta Austria Ges. m.b.H.
Minolta Camera Benelux B.V.
Belgium Branch
Minolta (Schweiz) AG
Minolta Svenska AB
Finland Branch
Minolta Portugal Limitada
Minolta Corporation
Head Office
Los Angeles Branch
Minolta Canada Inc.
Head Office
Vancouver Branch
Minolta Hong Kong Limited
Minolta Singapore (Pte) Ltd.
Shanghai Minolta Optical
Products Co., Ltd.

9222-2222-31 NI-A004

3-13, 2-Chome, Azuchi-Machi, Chuo-Ku, Osaka 541-8556, Japan

Kurt-Fischer-Strasse 50, D-22923 Ahrensburg, Germany
365 Route de Saint-Germain, F-78420 Carrières-Sur-Seine, France
7 Tanners Drive, Blakelands, Milton Keynes, MK14 5BU, England
Amalienstrasse 59-61, A-1131 Wien, Austria
Zonnebaan 39, P.O. Box 6000, NL-3600 HA Maarssen, The Netherlands
Prins Boudewijnlaan 1, B-2550 Kontich, Belgium
Riedstrasse 6, CH-8953 Dietikon, Switzerland
Albygatan 114, S-171 54 Solna, Sweden
Niittykatu 6 PL 37, SF-02201 Espoo, Finland
Av. do Brasil 33-A, P-1700 Lisboa, Portugal

101 Williams Drive, Ramsey, New Jersey 07446, U.S.A.
11150 Hope Street Cypress, CA 90630, U.S.A.

369 Britannia Road East, Mississauga, Ontario L4Z 2H5, Canada
230-3771 Jacombs Road, Richmond, B.C. V6V 2L9, Canada
Room 208, 2/F, Eastern Center, 1065 King's Road, Quarry Bay, Hong Kong
10, Teban Gardens Crescent, Singapore 608923

368 Minolta Road, Songjiang, Shanghai, China

©2000 Minolta Co., Ltd. under the Berne Convention and
Universal Copyright Convention

Printed in China

MINOLTA

VECTIS 3000

E INSTRUCTION MANUAL

