



LCD MONITOR

quick start guide

400UX-2 400UXN-2 460UX-2 460UXN-2

Introduction

Package Contents



Please make sure the following items are included with your LCD Display.

If any items are missing, contact your dealer.

Contact a local dealer to buy optional items.

Checking the Contents of the Package

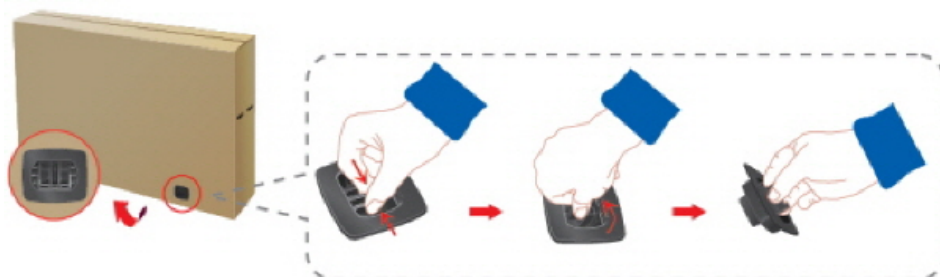

Remove the lock from the package box, as shown in the figure above.

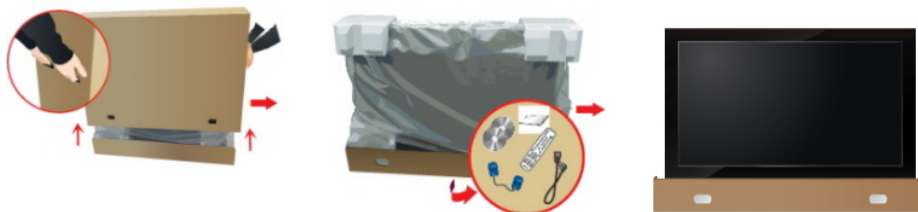

Lift up the package box by holding the grooves on both sides of the package box.

Check the contents of the package.

Remove the Styrofoam and vinyl cover.



- After unpacking the package, make sure to check the contents of the package.
- Make sure to keep the package box for transporting the product in the future.

Unpacking



LCD Display

Manuals



Quick Setup Guide



Warranty Card

(Not available in all locations)



User's Guide



MagicInfo Software CD,
MagicInfo Manual CD

(Applicable to the UXN-2 model only)

Cables



Power Cord

Others



Remote Control
(BP59-00138A)



Batteries (AAA X 2)
(Not available in all locations)



BNC to RCA Adaptor Jack
(Applicable to the UX-2 model only)

Sold separately



D-Sub Cable

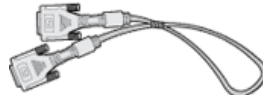

DVI Cable



LAN Cable
(Used with UXN-2 model only)

Sold separately

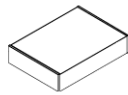

Wall Mount KIT



RGB to BNC Cable



BNC to BNC Cable

(Applicable to the UX-2 model only)

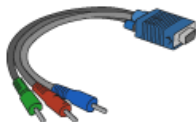

RGB to Component Cable



Semi Stand KIT

Your LCD Display

Front

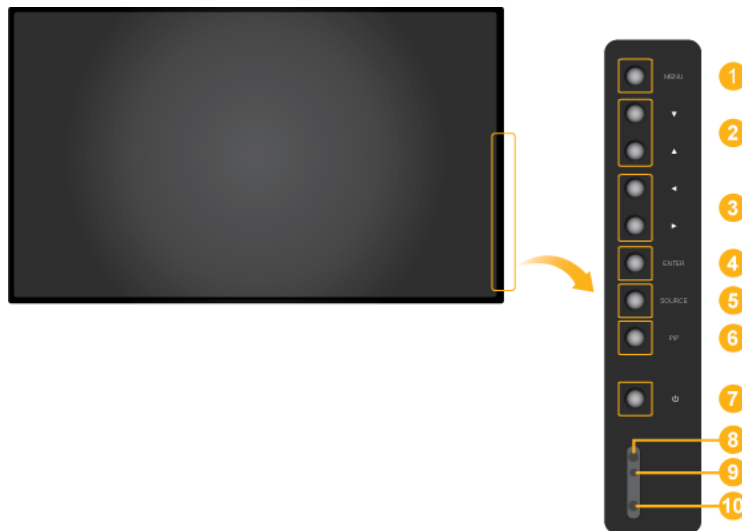

1 MENU button [MENU]

Opens the on-screen menu and exits from the menu. Also use to exit the OSD menu or return to the previous menu.

2 Navigate buttons (Up-Down buttons)

Moves from one menu item to another vertically or adjusts selected menu values.

3 Adjust buttons (Left-Right buttons) / Volume buttons

Moves from one menu item to another horizontally or adjusts selected menu values. When OSD is not on the screen, press the button to adjust volume.

4 ENTER button [ENTER]

Activates a highlighted menu item.

5 *SOURCE button [SOURCE]*

Switches from PC mode to Video mode. Selects the input source that an external device is connected to.

[PC] → [DVI] → [AV] → [Component] → [HDMI] → [MagicInfo]



Note

- The **BNC** mode will not be activated on the UXN-2 model.
- **MagicInfo** supports the UXN-2 model only.

6 *PIP button*

Push the PIP button to turn the PIP screen On / Off.

More than one PIP cannot overlap on screen as BNC and the component use the same terminal.

- **PC : DVI / AV / Component / HDMI**
- **BNC : DVI / AV / HDMI**
- **DVI / AV : PC / BNC**
- **Component : PC**
- **HDMI : PC / BNC**

7 *Power button [⏻]*

Use this button for turning the LCD Display on and off.

8 *Brightness Sensor (Optional)*

Automatically detects the surrounding brightness it accordingly.



Note

This function is activated only on the models equipped with an auto brightness sensor.

9 *Power indicator*

Shows PowerSaver mode by blinking green



Note

See PowerSaver described in the manual for further information regarding power saving functions. For energy conservation, turn your LCD Display OFF when it is not needed or when leaving it unattended for long periods.

10 *Remote Control Sensor*

Aim the remote control towards this spot on the LCD Display.

Rear



Note

For detailed information concerning cable connections, refer to Connecting Cables under Setup. The LCD Display 's configuration at the back may vary slightly depending on the LCD Display model.



 **Note**

E Applicable to the UX-2 model only.

F Applicable to the UXN-2 model only.

A

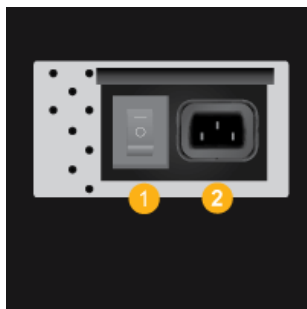

1 *POWER SW ON [|] / OFF [O]*

Switches the LCD Display On/Off.

2 *POWER*

The power cord plugs into the LCD Display and the wall outlet.

B

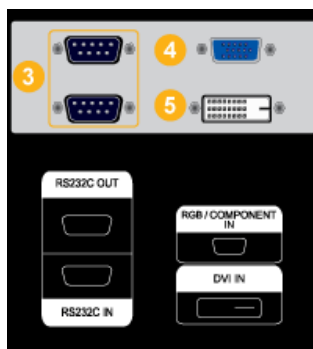

3 *RS232C OUT/IN (RS232C Serial PORT)*

MDC(Multiple Display Control) Program Port

4 *RGB/COMPONENT IN (PC/COMPONENT Connection Terminal (Input))*

- Use a D-Sub Cable (15 pin D-Sub) - PC mode (Analog PC)
- Connect the RGB/COMPONENT IN port on the monitor to the COMPONENT port on the external device using the D-SUB to COMPONENT cable.
- Connect the RGB/COMPONENT IN port on the monitor to the BNC port on the PC using the D-SUB to BNC cable.

C

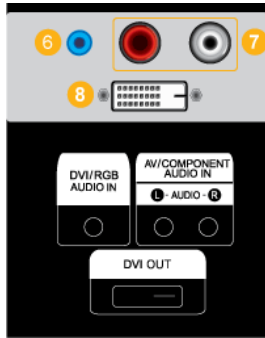

5 *DVI IN (PC Video Connection Terminal)*

Use a DVI Cable (DVI-D to DVI-D) - DVI mode (Digital PC)

6 *DVI/RGB/HDMI AUDIO IN (PC/DVI/HDMI(PC) Audio Connection Terminal (Input))*

7 *AV/COMPONENT AUDIO IN [L- AUDIO- R]*

Connect the port of the DVD, VCR (DVD / DTV Set-Top Box) to the [L- AUDIO - R] port of the LCD Display.

8 *DVI OUT*

- Connect a monitor to another monitor through a DVI cable.
- Connect the DVI OUT port on the monitor to the HDMI IN port on the other monitor using the DVI to HDMI cable.
- DVI, HDMI and network signals sent via the DVI OUT port are displayed on the second display which has the DVI IN port.

 **Note**

Up to 6 Full HD or 10 HD monitors can be connected (May differ depending on the product).

D

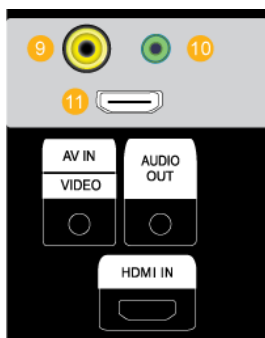

9 *AV IN [VIDEO]*

Connect the [VIDEO] terminal of your monitor to the video output terminal of the external device using a VIDEO cable.

10 *AUDIO OUT*

Headphone/External speaker output terminal.

11 *HDMI IN*

Connect the HDMI terminal at the back of your LCD Display to the HDMI terminal of

your digital output device using a HDMI cable.

Up to HDMI cable 1.0 can be supported.

E

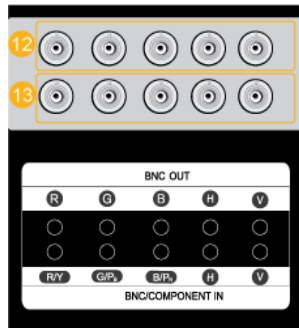

12 BNC OUT [R, G, B, H, V] (BNC Terminal (Output))

BNC (Analog PC) Connection: connecting the R, G, B, H, V ports.

The number of LCD Displays that can be connected to the loopout depends on the cables, signal source, etc. With cables or signal source where there is no degradation, up to 10 LCD Displays can be connected (May not be supported depending on the connected cable).



Note

(Applicable to the UX-2 model only)

13 (BNC/Component Connection Terminal (input))

During component input, please check specifications for the input ports below.

[R/Y, G/P_B, B/P_R, H, V]

- [R/Y] --> Red port input
- [G/P_B] --> Green port input
- [B/P_R] --> Blue port input



Note

Applicable to the UX-2 model only.

F

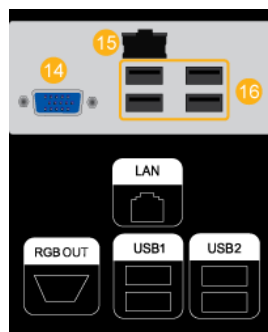

14 RGB OUT



Note

Applicable to the UXN-2 model only.

15 LAN (LAN Connection Terminal)



Note

Applicable to the UXN-2 model only.

16 USB1, USB2 (USB Connection Terminal)

Keyboard / Mouse, Mass Storage Device Compatible.



Applicable to the UXN-2 model only.

G

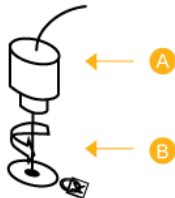

Kensington Lock

The Kensington Lock is a device used to physically fix the system when using it in a public place. The locking device has to be purchased separately. The appearance and locking method may differ from the illustration depending on the manufacturer. Refer to the manual provided with the Kensington Lock for proper use. The locking device has to be purchased separately.



The location of the Kensington Lock may be different depending on the model.

Using the Anti-Theft Kensington Lock

1. Insert the locking device into the Kensington slot on the LCD Display **B** and turn it in the locking direction **A**.
2. Connect the Kensington Lock cable.
3. Fix the Kensington Lock to a desk or a heavy stationary object.



See Connecting Cables for further information regarding cable connections.







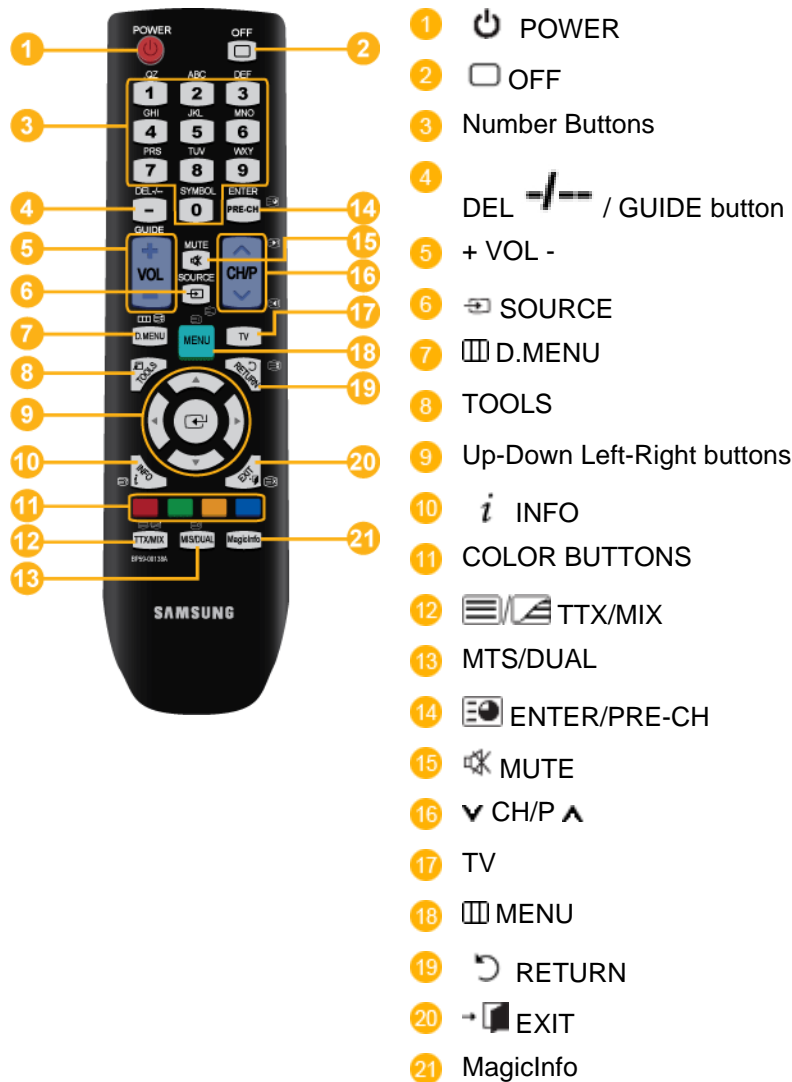

Remote Control



The performance of the remote control may be affected by a TV or other electronic device operating near the LCD Display, causing a malfunction due to interference with the frequency.



- | | |
|------------------------|--|
| 1. POWER | Turns the product On. |
| 2. OFF | Turns the product Off. |
| 3. Number Buttons | Press to change the channel. |
| 4. DEL / GUIDE button | The "-" button is used to select Digital channels. Electronic Program Guide (EPG) display. - This function does not work for this LCD Display. |
| 5. + VOL - | Adjusts the audio volume. |
| 6. SOURCE | Press the button to change the input signal SOURCE. Changing the SOURCE is only allowed for external devices that are connected to the LCD Display at the time. |
| 7. D.MENU | DTV menu display - This function does not work for this LCD Display. |
| 8. TOOLS | Use to quickly select frequently used functions. |

9. Up-Down Left-Right buttons
Moves from one menu item to another horizontally, vertically or adjusts selected menu values.
10.  INFO
Current picture information is displayed on the upper left corner of the screen.
11. COLOR BUTTONS
Press to add or delete channels and to store channels to the favorite channel list in the "Channel List" menu.
- This function does not work for this LCD Display.
12.  TTX/MIX
TV channels provide written information services via teletext.
- Teletext Buttons

- This function does not work for this LCD Display.
13. MTS/DUAL
- This function does not work for this LCD Display.
MTS-
You can select MTS (Multichannel Television Stereo) mode.
- | | Audio Type | MTS/S_Mode | Default |
|-----------|------------|---------------|---------------|
| FM Stereo | Mono | Mono | Manual Change |
| | Stereo | Mono ↔ Stereo | |
| | SAP | Mono ↔ SAP | Mono |
- DUAL-*
STEREO/MONO, DUAL I / DUAL II and MONO/NICAM MONO/NICAM STEREO can be operated depending on the broadcasting type by using the DUAL button on the remote control while watching TV.
14.  ENTER/PRE-CH
This button is used to return to the immediately previous channel.
- This function does not work for this LCD Display.
15.  MUTE
Pauses (mutes) the audio output temporarily. This is displayed on the lower left corner of the screen. The audio comes back on if MUTE or - VOL + is pressed in the Mute mode.
16.  CH/P 
In **TV** mode, selects TV channels.
- This function does not work for this LCD Display.
17. TV
Selects the TV mode directly.
- This function does not work for this LCD Display.
18.  MENU
Opens the on-screen menu and exits from the menu or closes the adjustment menu.
19.  RETURN
Returns to the previous menu.

20. →  EXIT

Exits from the menu screen.

21. MagicInfo

MagicInfo Quick Launch Button.

Connections

Connecting a Computer



AV input devices such as DVD players, VCRs or camcorders as well as your computer can be connected to the LCD Display. For detailed information on connecting AV input devices, refer to the contents under Adjusting Your LCD Display.

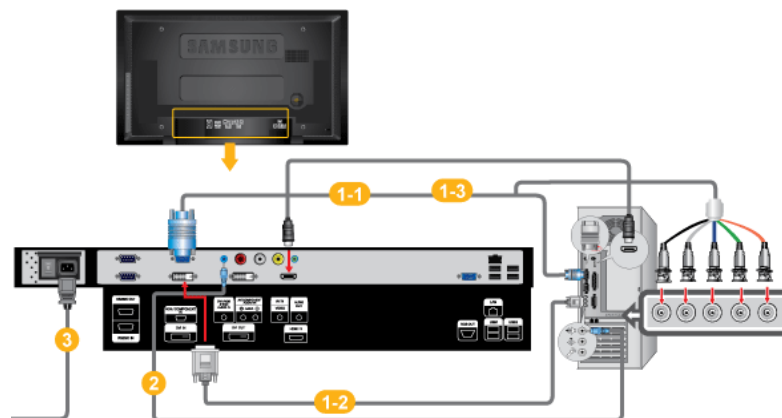

(400UXN-2,460UXN-2)

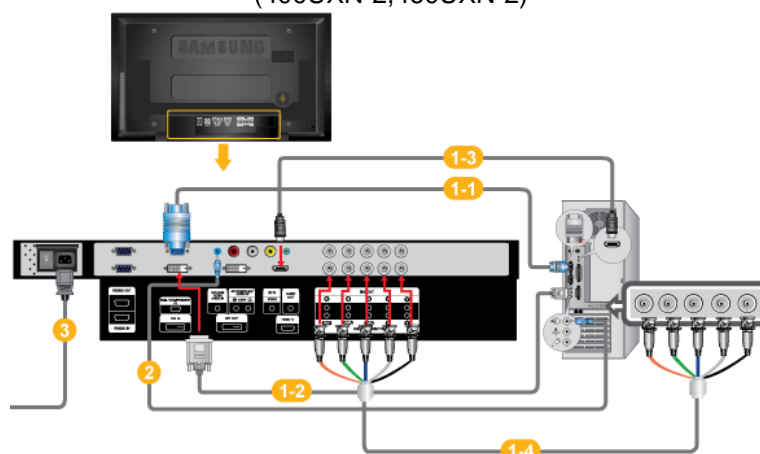

(400UX-2,460UX-2)

- 1 There are several ways to connect the computer to the monitor. Choose one from the following options.

1-1 Using the D-sub (Analog) connector on the video card.

- Connect the D-sub to the 15-pin, RGB port on the back of your LCD Display and the 15 pin D-sub Port on the computer.

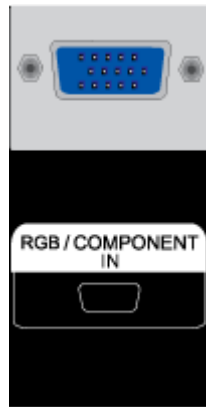

1-2 Using the DVI (Digital) connector on the video card.

- Connect the DVI Cable to the DVI port on the back of your LCD Display and the DVI port on the computer.

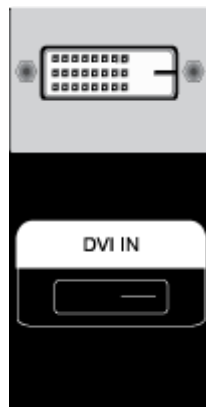

1-3 Using the HDMI (digital) output on the graphics card.

- Connect the HDMI IN port on the monitor to the HDMI port on the PC using the HDMI cable.

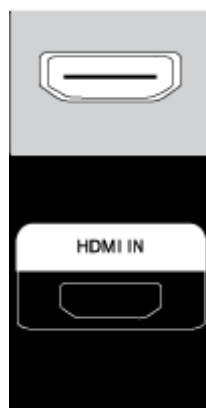

 **Note**

When the HDMI cable to the PC, ensure that you select **HDMI** from both the **Source List** and **Edit Name** before selecting **PC** or **DVI** device so that normal PC screen and sound can be outputted. Note that sound is only available when connected according to the option **2** that follows.

1-4 Using the BNC (Analog) connector on the video card. (Applicable to the UX-2 model only)

- Connect the BNC/COMPONENT IN port on the monitor to the BNC port on the PC using the BNC to BNC cable.

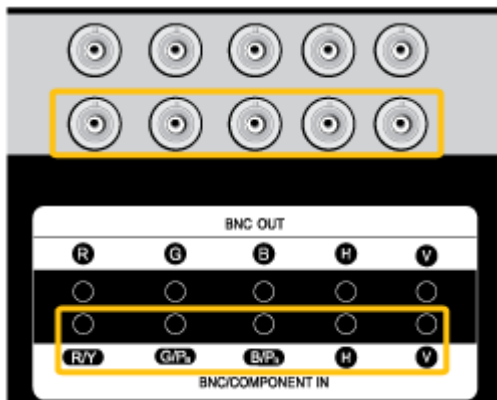

- 2 Connect the audio cable for your LCD Display to the audio port on the back of the LCD Display.
- 3 Connect the power cord for your LCD Display to the power port on the back of the LCD Display. Turn on the power switch.

 **Note**

- Turn on both your computer and the LCD Display.
- Contact a local SAMSUNG Electronics Service Center to buy optional items.

Connecting to Other devices

 **Note**

- AV input devices such as DVD players, VCRs or camcorders as well as your computer can be connected to the LCD Display. For detailed information on connecting AV input devices, refer to the contents under Adjusting Your LCD Display.
- The LCD Display 's configuration at the back may vary slightly depending on the LCD Display model.

Connecting AV Devices

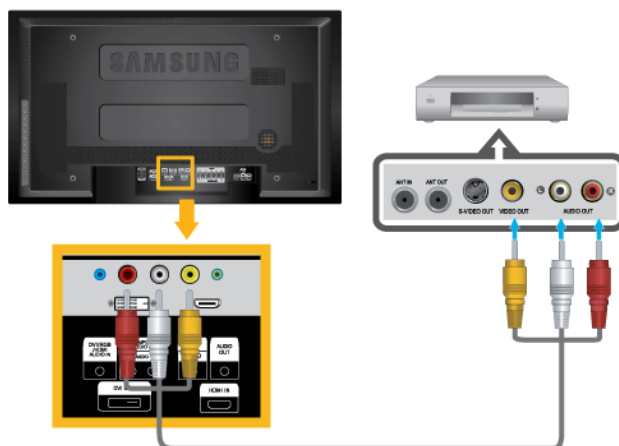

1. Connect the Video and [R-AUDIO-L] port of the DVD, VCR or DTV Set-Top Box to the Video and [R-AUDIO-L] LCD Display.
2. Play the DVD, VCR or Camcorder with a DVD disc or tape inserted.
3. Select **AV** using the SOURCE .

Connecting the BNC to BNC cable

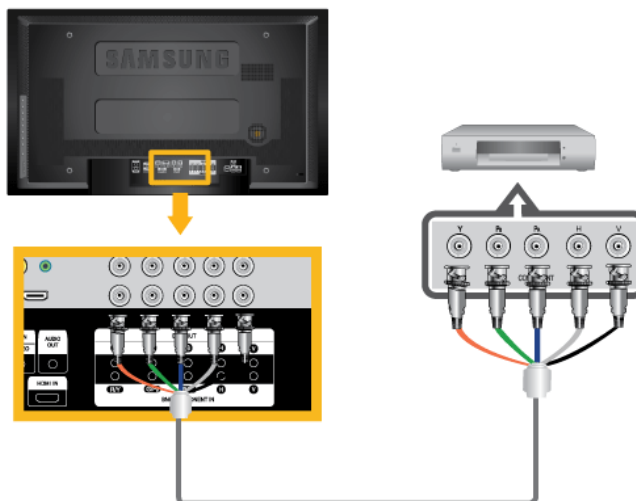

1. Connect the BNC/COMPONENT IN [R/Y, G/P_B, B/P_R] ports on the monitor to the BNC port on the external device using the BNC to BNC cable.
2. Select **BNC** for the Camcorder connection using the Source button on the front of the LCD Display or on the remote control.

 **Note**

Applicable to the UX-2 model only.

Connecting a DVD Player - Applicable to the UX-2 model only.

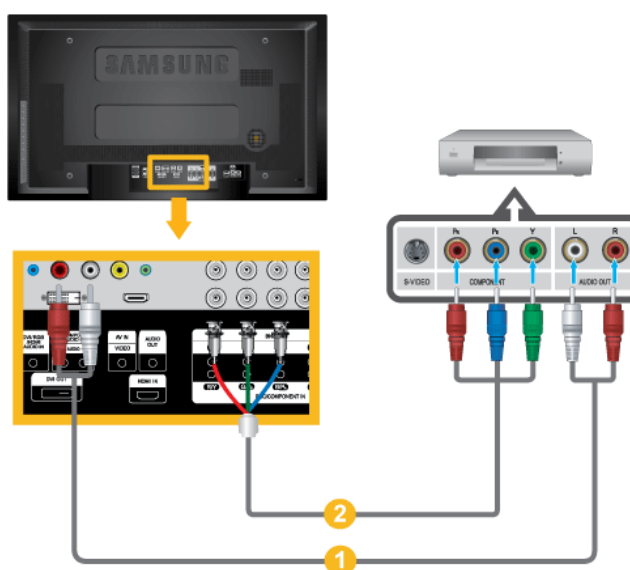

1. Connect a set of audio cables between the AV/COMPONENT AUDIO IN [L-AUDIO-R] on the LCD Display and the AUDIO OUT jacks on the DVD player.

2. Connect a Component cable between the BNC/COMPONENT IN [R/Y, G/P_B, B/P_R] port on the LCD Display and the P_R, Y, P_B jacks on the DVD player.

 **Note**

- Select **Component** for the connection to a DVD player using the SOURCE button on the front of the LCD Display or on the remote control.
- Then, start the DVD Player with a DVD disc inserted.
- A component cable is optional.
- For an explanation of Component video, consult your DVD manual.

Connecting using a Component Cable

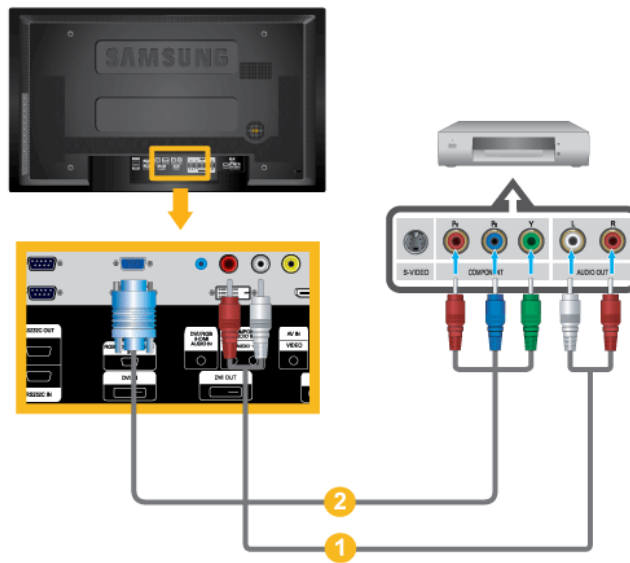

1. Connect a set of audio cables between the AV/COMPONENT AUDIO IN [L-AUDIO-R] on the LCD Display and the AUDIO OUT jacks on the DVD player or other external device.
2. Connect the Component/ D-sub cable to the RGB/COMPONENT IN ports on the monitor.

 **Note**

- Select Component using the SOURCE button on the front of the LCD Display or on the remote control.
- Then, start the DVD Player with a DVD disc inserted.
- A component cable is optional.
- For an explanation of Component video, consult your DVD or external device's user manual.

Connecting to a Camcorder

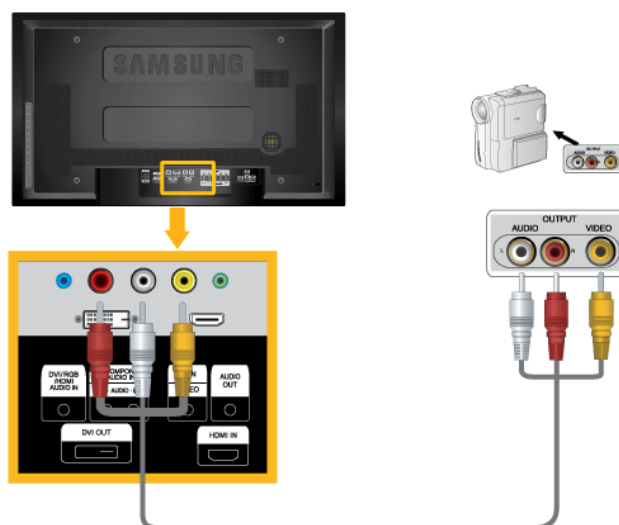

1. Locate the AV output jacks on the camcorder. They are usually found on the side or back of the camcorder. Connect a set of audio cables between the AUDIO OUTPUT jacks on the camcorder and the AV/COMPONENT AUDIO IN [L-AUDIO-R] on the LCD Display .
2. Connect a video cable between the VIDEO OUTPUT jack on the camcorder and the AV IN [VIDEO] on the LCD Display .
3. Select **AV** for the Camcorder connection using the Source button on the front of the LCD Display or on the remote control.
4. Then, start the Camcorder with a tape inserted.

Note

The audio-video cables shown here are usually included with a Camcorder. (If not, check your local electronics store.) If your camcorder is stereo, you need to connect a set of two cables.

Connecting Using a HDMI Cable

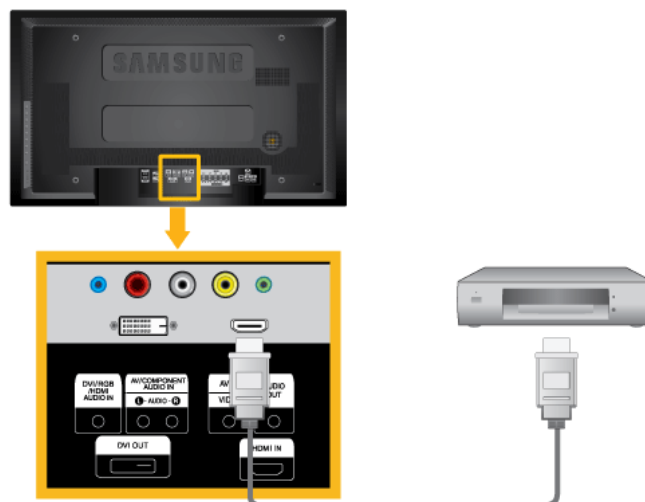

1. Connect input devices such as a Blu-Ray/DVD player to the HDMI IN terminal of the LCD Display using an HDMI cable.

 **Note**

In **HDMI** mode, only PCM format audio is supported.

Connecting Using a DVI Cable

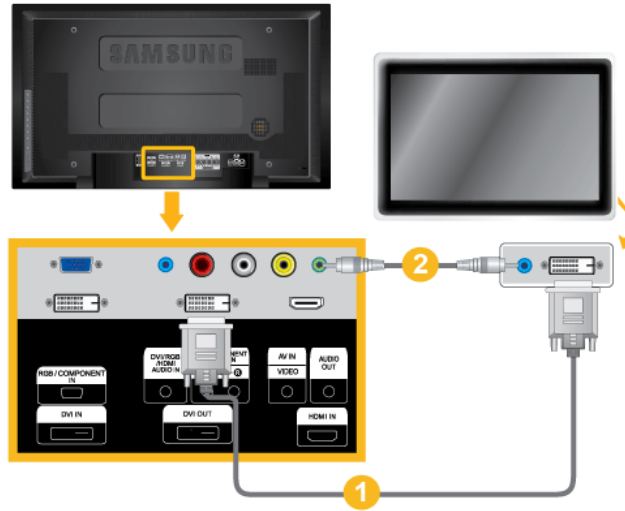

1. Connect between the DVI OUT port on the LCD Display and the input port on another monitor using a DVI cable.
2. Connect between the AUDIO OUT port on the LCD Display and the audio input port on another monitor using a stereo cable.
3. Select DVI using the SOURCE button on the front of the LCD Display or on the remote control.

 **Note**

DVI OUT does not support HDCP.

Connecting Using a DVI to HDMI Cable

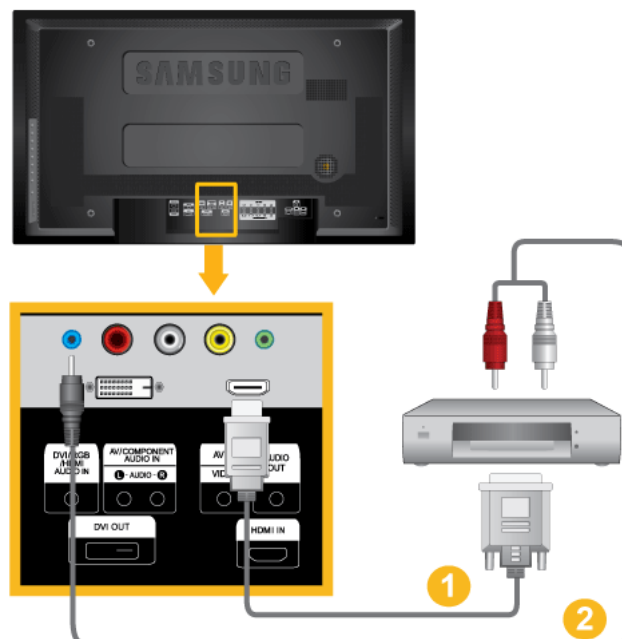

1. Connect the DVI output terminal of a digital output device to the HDMI IN terminal of the LCD Display using a DVI to HDMI cable.
2. Connect the red and white jacks of an RCA to stereo (for PC) cable to the same colored audio output terminals of the digital output device, and connect the opposite jack to the DVI / RGB /HDMI AUDIO IN terminal of the LCD Display.

Connecting a DTV Set Top (Cable/Satellite) Box - Applicable to the UX-2 model only.

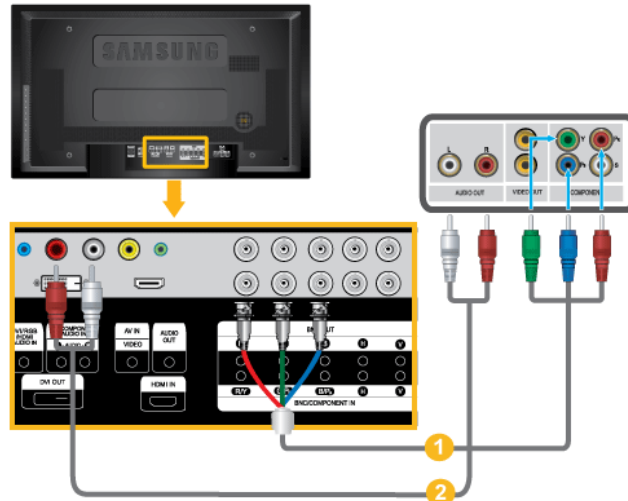

1. Connect a Component cable between the BNC/COMPONENT IN [R/Y, G/P_B, B/P_R] port on the LCD Display and the P_R, Y, P_B jacks on the Set Top Box.
2. Connect a set of audio cables between the AV COMPONENT AUDIO IN [L-AUDIO-R] on the LCD Display and the AUDIO OUT jacks on the Set Top Box.

 **Note**

- Select **Component** for the connection to a DTV Set Top Box using the SOURCE button on the front of the LCD Display or on the remote control.
- For an explanation of Component video, see your Set Top Box owner's manual.

Connecting a DTV Set Top (Cable/Satellite) Box

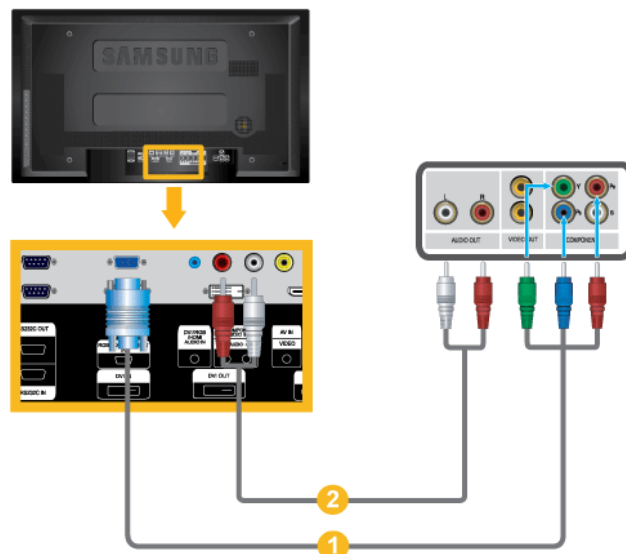

1. Connect the RGB/COMPONENT IN ports on the monitor to the P_R, Y, P_B ports on the set-top box using the Component/ D-sub cable.
2. Connect a set of audio cables between the AV COMPONENT AUDIO IN [L-AUDIO-R] on the LCD Display and the AUDIO OUT jacks on the Set Top Box.

 **Note**

- Select Component using the SOURCE button on the front of the LCD Display or on the remote control.
- For an explanation of Component video, see your Set Top Box owner's manual.

Connecting to an Audio System

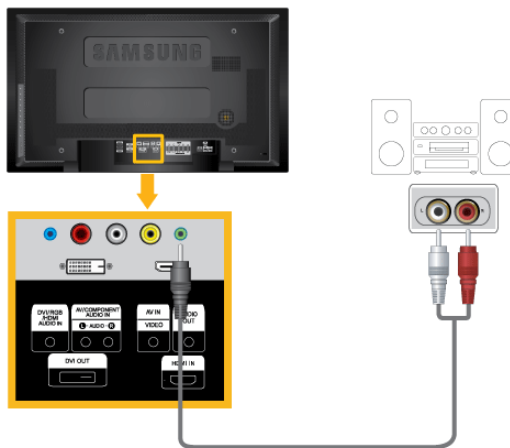

1. Connect a set of audio cables between the AUX L, R jacks on the AUDIO SYSTEM and AUDIO OUT on LCD Display.

Connecting a LAN Cable

 **Note**

- AV input devices such as DVD players, VCRs or camcorders as well as your computer can be connected to the LCD Display. For detailed information on connecting AV input devices, refer to the contents under Adjusting Your LCD Display.
- The LCD Display 's configuration at the back may vary slightly depending on the LCD Display model.

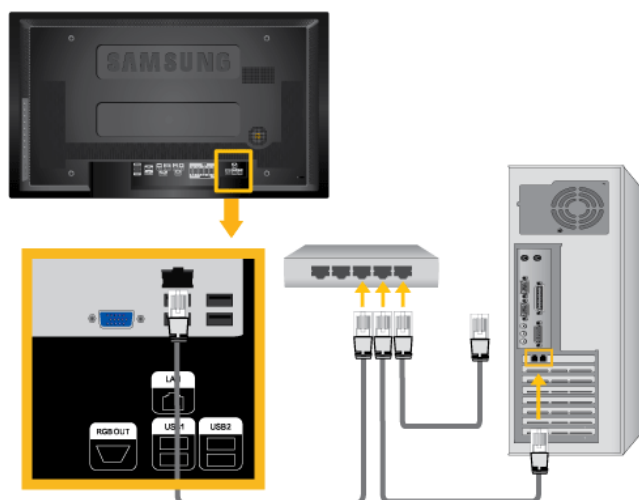

Connect the LAN cable.

 **Note**

Applicable to the UXN-2 model only.

Connecting a USB device

 **Note**

- You can connect USB devices such as a mouse or keyboard.
- Applicable to the UXN-2 model only.

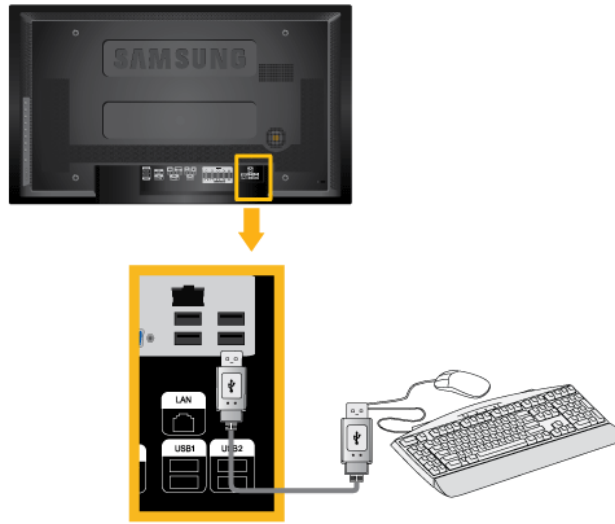

Troubleshooting

Self-Test Feature Check



Check the following items yourself before calling for assistance. Contact a Service Center for problems that you cannot solve by yourself.

Self-Test Feature Check

1. Turn off both your computer and the LCD Display.
2. Unplug the video cable from the back of the computer.
3. Turn on the LCD Display.

The figure shown below ("**Check Signal Cable**") appears on a black background when the LCD Display is working normally even though no video signal is detected: While in the Self-Test mode, the LED power indicator remains green and the figure moves around on the screen.



4. Turn off your LCD Display and reconnect the video cable; then turn on both your computer and the LCD Display

If your LCD Display screen remains blank after using the previous procedure, check your video controller and computer system; your LCD Display is functioning properly.

Warning Messages

You can even view the screen at a resolution of 1920 x 1080. However, you will receive the following message for a minute; You can choose to change the screen resolution or stay in the current mode during that time. If the resolution is more than 85Hz, you will see the black screen because the LCD Display does not support over 85Hz.

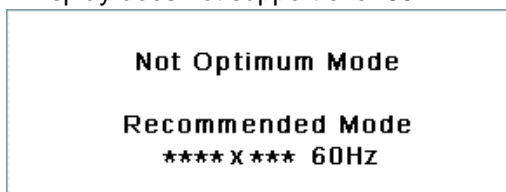

Refer to Specifications > Preset Timing Modes for the resolutions or frequencies supported by the LCD Display.

Maintenance and Cleaning

- 1) Maintaining the LCD Display Case.

Clean with a soft cloth after disconnecting the power cord.



- Do not use benzene, thinner or other flammable substances, or a wet cloth.
- We recommend that a SAMSUNG cleansing agent is used to prevent damage to the screen.

2) Maintaining the Flat Panel Display Screen.

Clean with a soft cloth (cotton flannel) smoothly.



- Never use acetone, benzene or thinner.
(They may cause flaws or deformation of the screen surface.)
- The user will be required to pay costs and related expenses for repairing damages caused.

Symptoms and Recommended Actions



Note

A LCD Display recreates visual signals received from the computer. Therefore, if there is a problem with the computer or the video card, this can cause the LCD Display to become blank, have poor coloring, become noisy, etc. In this case, first check the source of the problem, and then contact a Service Center or your dealer.

1. Check if the power cord and the video cables are properly connected to the computer.
2. Check if the computer beeps more than 3 times when booting.
(If it does, request service.)
3. If you installed a new video card or if you assembled the PC, check if you installed the Adaptor(video).
4. Check if the scanning ratio of the video screen is set to between 50 Hz ~ 85 Hz.
(Do not exceed 60Hz when using the maximum resolution.)
5. If you have problems in installing the Adaptor (video) driver, boot the computer in Safe Mode, remove the Display Adaptor in the "Control Panel -> System -> Device Administrator" and then reboot the computer to reinstall the Adaptor (video) driver.

Check List



Note

- The following table lists possible problems and their solutions. Before calling for assistance, check the information in this section to see if you can remedy any problems for yourself. If you do need assistance, please call the phone number on the Information section or contact your dealer.
- For more network-related information, refer to the MagicInfo Troubleshooting section.

Problems related to the Installation (PC Mode)



Note

Problems related to the LCD Display installation and their solutions are listed.

Q: The LCD Display screen flickers.

A: Check if the signal cable between the computer and the LCD Display is securely connected.

(Refer to Connecting a Computer)

Problems related to the Screen



Note

Problems related to the LCD Display screen and their solutions are listed.

Q: The screen is blank and the power indicator is off.

A: Ensure that the power cord is firmly connected and the LCD Display is on.

(Refer to the Connecting a Computer)

Q: "**Check Signal Cable**" message.

A: Ensure that the signal cable is firmly connected to the PC or video sources.

(Refer to the Connecting a Computer)

A: Ensure that the PC or video sources are turned on.

Q: "**Not Optimum Mode**" message.

A: Check the maximum resolution and the frequency of the video Adaptor.

A: Compare these values with the data in the Preset Timing Modes Chart.

Q: The picture rolls vertically.

A: Check if the signal cable is securely connected. Re-connect it, if necessary.

(Refer to Connecting a Computer)

Q: The image is not clear; picture is blurred.

A: Run Frequency **Coarse** and **Fine** tuning.

A: Turn on again after removing all accessories (video extension cable, etc.)

A: Set the resolution and frequency to the recommended ranges.

Q: The picture image is unstable and shakes.

A: Check if the resolution and frequency set for the computer video card falls in the range supported by the LCD Display. If not, reset them referring to the current Information under the LCD Display menu and Preset Timing Modes.

Q: Ghost images are shown in the picture.

A: Check if the resolution and frequency set for the computer video card falls in the range supported by the LCD Display. If not, reset them referring to the current Information under the LCD Display menu and Preset Timing Modes.

Q: The image is too light or too dark.

A: Adjust the **brightness** and **contrast**.

(Refer to the **Brightness, Contrast**)

- Q: The screen color is inconsistent.
- A: Adjust color using **Custom** under OSD Color Adjustment menu.
- Q: The color image is distorted by dark shadows.
- A: Adjust color using **Custom** under OSD Color Adjustment menu.
- Q: The color white is poor.
- A: Adjust color using **Custom** under OSD Color Adjustment menu.
- Q: The Power Indicator blinks.
- A: The LCD Display is currently saving the changes made in the settings to the OSD memory.
- Q: The screen is blank and the power indicator light blinks every 0.5 or 1 seconds.
- A: The LCD Display is using its power management system. Press any key on the keyboard.
- Q: The screen is blank and it is blinking.
- A: If you see the "**TEST GOOD**" message on the screen when you pressing the MENU button, check the cable connection between the LCD Display and the computer to ensure that the connector is properly connected.

Problems related to Audio



Note

Problems related to audio signals and their solutions are listed below.

- Q: No sound.
- A: Ensure that the audio cable is firmly connected to both the audio-in port on your LCD Display and the audio-out port on your sound card.
- (Refer to the Connecting a Computer)
- A: Check the volume level.
- Q: The sound level is too low.
- A: Check the volume level.
- A: If the volume is still too low after turning the control to its maximum, check the volume control on the computer sound card or software program.
- Q: The sound is too high or too low.
- A: Adjusts the **Treble** and **Bass** to the appropriate levels.

Problems related to the Remote Control



Note

Problems related to the remote control and their solutions are listed.

- Q: The remote control buttons do not respond.
- A: Check the polarities (+/-) of the batteries.

- A: Check if the batteries are empty.
- A: Check if the power is on.
- A: Check if the power cord is securely connected.
- A: Check if a special fluorescent or neon lamp is on in the vicinity.

Q & A

Q: How can I change the frequency?

A: The frequency can be changed by reconfiguring the video card.



That video card support can vary, depending on the version of the driver used. (Refer to the computer or the video card manual for details.)

Q: How can I adjust the resolution?

A: Windows XP:

Set the resolution in the Control Panel → Appearance and Themes → Display → Settings.

A: Windows ME/2000:

Set the resolution in the Control Panel → Display → Settings.

* Contact the video card manufacturer for details.

Q: How can I set the Power Saving function?

A: Windows XP:

Set the resolution in the Control Panel → Appearance and Themes → Display → Screen Saver.

Set the function in the BIOS-SETUP of the computer. (Refer to the Windows / Computer Manual).

A: Windows ME/2000:

Set the resolution at the Control Panel → Display → Screen Saver.

Set the function in the BIOS-SETUP of the computer. (Refer to the Windows / Computer Manual).

Q: How can I clean the outer case/LCD Panel?

A: Disconnect the power cord and then clean the LCD Display with a soft cloth, using either a cleaning solution or plain water.

Do not leave any detergent or scratches on the case. Do not let any water enter the LCD Display.

Q: How can I play the video?

A: The video supports the MPEG1 and WMV codecs only. Install the corresponding codec to play the video. Note that some of the codecs can be incompatible.



Before calling for assistance, check the information in this section to see if you can remedy any problems yourself. If you do need assistance, please call the phone number on the Information section or contact your dealer.