







Explorer 4250HD Home Gateway



Notice to Installers

The servicing instructions in this notice are for use by qualified service personnel only. To reduce the risk of electric shock, do not perform any servicing other than that contained in the operating instructions, unless you are qualified to do so.

<p>Note to System Installer</p> <p>For this apparatus, the coaxial cable shield/ screen shall be grounded as close as practical to the point of entry of the cable into the building. For products sold in the US and Canada, this reminder is provided to call the system installer's attention to Article 820-93 and Article 820-100 of the NEC (or Canadian Electrical Code Part 1), which provides guidelines for proper grounding of the coaxial cable shield.</p>	<div style="display: flex; justify-content: space-between; align-items: center;">  <div style="text-align: center;"> <p>CAUTION</p> <p>RISK OF ELECTRIC SHOCK DO NOT OPEN</p> </div>  </div> <div style="display: flex; justify-content: space-between; align-items: center;">  <div style="text-align: center;"> <p>AVIS</p> <p>RISQUE DE CHOC ÉLECTRIQUE NE PAS OUVRIR</p> </div>  </div>
<div style="text-align: center;">  </div> <p>This symbol is intended to alert you that uninsulated voltage within this product may have sufficient magnitude to cause electric shock. Therefore, it is dangerous to make any kind of contact with any inside part of this product.</p>	<p>CAUTION: To reduce the risk of electric shock, do not remove cover (or back). No user-serviceable parts inside. Refer servicing to qualified service personnel.</p> <p>WARNING TO PREVENT FIRE OR ELECTRIC SHOCK, DO NOT EXPOSE THIS UNIT TO RAIN OR MOISTURE.</p> <div style="text-align: center;">  </div> <p>This symbol is intended to alert you of the presence of important operating and maintenance (servicing) instructions in the literature accompanying this product.</p>

20070112 SysInstaller 820 English

U.S. Patents

A patent notice is affixed to this product. In addition, the product may also be covered by one or more of the following patents:

4,498,169; 4,692,919; 4,748,667; 4,829,569; 4,866,770; 4,885,775; 4,888,799; 4,890,319; 4,922,456; 4,922,532; 4,924,498; 4,965,534; 4,991,011; 5,003,384; 5,012,510; 5,029,207; 5,045,816; 5,053,883; 5,054,071; 5,058,160; 5,142,575; 5,142,690; 5,146,526; 5,155,590; 5,214,390; 5,225,902; 5,225,925; 5,235,619; 5,237,610; 5,239,540; 5,241,610; 5,247,364; 5,255,086; 5,257,403; 5,267,071; 5,270,809; 5,271,041; 5,272,752; 5,282,028; 5,285,497; 5,287,351; 5,301,028; 5,309,514; 5,317,391; 5,319,709; 5,341,425; 5,347,388; 5,347,389; 5,357,276; 5,359,601; 5,361,156; 5,367,571; 5,379,141; 5,379,145; 5,381,481; 5,390,337; 5,400,401; 5,406,558; 5,418,782; 5,420,866; 5,420,923; 5,425,101; 5,428,404; 5,430,568; 5,434,610; 5,436,749; 5,438,370; 5,440,632; 5,442,472; 5,455,570; 5,457,701; 5,471,492; 5,477,199; 5,477,262; 5,477,282; 5,477,370; 5,481,389; 5,481,542; 5,485,221; 5,493,339; 5,497,187; 5,500,758; 5,502,499; 5,506,904; 5,519,780; 5,539,822; 5,550,825; 5,579,055; 5,579,057; 5,583,562; 5,592,551; 5,596,606; 5,600,378; 5,602,933; 5,640,388; 5,657,414; 5,675,575; 5,684,876; 5,715,515; 5,724,525; 5,734,822; 5,740,300; 5,742,677; 5,754,940; 5,757,416; 5,771,064; 5,774,859; 5,825,829; 5,826,167; 5,850,305; 5,854,703; 5,870,474; 5,892,607; 5,920,626; 5,923,755; 5,930,024; 5,930,515; 5,937,067; 5,963,352; 5,966,163; 5,982,424; 5,991,139; 5,999,207; 6,005,631; 6,005,938; 6,016,163; 6,028,941; 6,029,046; 6,052,384; 6,055,244; 6,072,532; 6,105,134; 6,148,039; 6,157,719; 6,188,729; 6,195,389; 6,212,278; 6,215,530; 6,219,358; 6,240,103; 6,243,145; 6,246,767; 6,252,964; 6,272,226; 6,292,081; 6,292,568; 6,320,131; 6,374,275; 6,405,239; 6,411,602; 6,417,949; 6,424,714; 6,424,717; 6,433,906; 6,438,139; 6,463,586; 6,467,091; 6,476,878; 6,493,876; 6,510,519; 6,516,002; 6,516,412; 6,526,508; 6,538,595; 6,546,013; 6,560,340; 6,567,118; 6,570,888; 6,622,308; 6,629,227; 6,664,984; 6,667,994; 6,671,879; 6,674,967; 6,678,891; 6,714,598; 6,721,352; 6,721,956; 6,725,459; 6,738,982; 6,744,892; 6,744,967; 6,751,271; 6,760,918; 6,795,972; 6,802,077; 6,804,708; 6,811,447; 6,817,028; 6,822,972; 6,823,385; 6,832,386; 6,845,106; 6,868,473; 6,874,075; 6,889,191; 6,909,471; 6,917,622; 6,917,628; 6,922,412; 6,927,806; 6,928,656; 6,931,058; 6,937,729; 6,969,279; 6,971,008; 6,971,121; 6,978,310; 6,986,156; 6,988,900; 6,996,838; 7,010,801; 7,053,960; 7,065,213; 7,069,578; 7,069,572; D348065; D354959; D359737; D363932; D390217; D434753; D507240; D507535; D513407; D516518; RE36368; RE36988

20070417 Patents

Contents

Important Safety Instructions.....	2
Welcome to the Explorer 4250HD.....	4
Safety First.....	4
Explorer 4250HD Home Gateway Serial Number.....	4
Front Panel Features.....	5
Back Panel Connectors.....	6
Connecting the 4250HD.....	7
Connections for a HDTV and VCR.....	8
Connections for a Standard-Definition TV and VCR.....	10
Performance Tips.....	11
Automatic Software Updates.....	11
Watching TV.....	12
Connection Diagrams.....	13
Frequently Asked Questions About HDTV and Digital TV.....	19
Picture Formats.....	20
Compliance Information.....	21

IMPORTANT SAFETY INSTRUCTIONS

Read These Instructions

Keep These Instructions

Heed All Warnings

Follow All Instructions

Power Source Warning

A label on this product indicates the correct power source for this product. Operate this product only from an electrical outlet with the voltage and frequency indicated on the product label. If you are uncertain of the type of power supply to your home or business, consult your service provider or your local power company.

The AC inlet on the unit must remain accessible and operable at all times.

Ground the Product



WARNING: Avoid electric shock and fire hazard! Do not defeat the safety purpose of the polarized or grounding-type plug. A polarized plug has two blades with one wider than the other. A grounding-type plug has two blades and a third grounding prong. The wide blade or the third prong is provided for your safety. If the provided plug does not fit into your outlet, consult an electrician for replacement of the obsolete outlet.

If this product connects to coaxial cable wiring, be sure the cable system is grounded (earthed). Grounding provides some protection against voltage surges and built-up static charges.

Outdoor Grounding System

If this product connects to an outdoor antenna or cable system, be sure the antenna or cable system is grounded (earthed). This provides some protection against voltage surges and built-up static charges.

Article 810 of the National Electric Code (NEC) ANSI/NFPA No. 70-1990, provides the following information:

- Grounding of the mast and supporting structure
- Grounding the lead-in wire to an antenna discharge unit
- Size of the grounding conductors
- Location of the antenna-discharge unit
- Connection to grounding electrodes

- Requirements for the grounding electrodes (see the following antenna grounding diagram as recommended by NEC ANSI/NFPA 70)

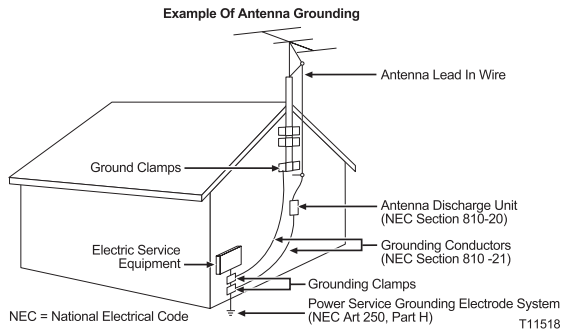

WARNING: Avoid electric shock and fire hazard! Do not locate an outside antenna system in the vicinity of overhead power lines or power circuits. Touching power lines or circuits might be fatal.

Protect the Product from Lightning

For added protection, unplug this apparatus during lightning storms or when unused for long periods of time. In addition to disconnecting the AC power from the wall outlet, disconnect the signal inputs.

Verify the Power Source from the On/Off Power Light

When the on/off power light is not illuminated, the apparatus may still be connected to the power source. The light goes out when the apparatus is turned off, regardless of whether it is still plugged into an AC power source.

Eliminate AC Mains Overloads



WARNING: Avoid electric shock and fire hazard! Do not overload AC mains, outlets, extension cords, or integral convenience receptacles. For products that require battery power or other power sources to operate them, refer to the operating instructions for those products.

IMPORTANT SAFETY INSTRUCTIONS, continued

Prevent Power Cord Damage

Protect the power cord from being walked on or pinched, particularly at plugs, convenience receptacles, and the point where the cord exits from the apparatus.

Provide Ventilation and Select a Location

- Do not block any ventilation openings. Install in accordance with the manufacturer's instructions.
- Do not place this apparatus on a bed, sofa, rug, or similar surface.
- Do not place this apparatus on an unstable surface.
- Do not install near any heat sources such as radiators, heat registers, stoves, or other apparatus (including amplifiers) that produce heat.
- Do not install this apparatus in an enclosure, such as a bookcase or rack, unless the installation provides proper ventilation.
- Do not place entertainment devices (such as VCRs or DVDs), lamps, books, vases with liquids, or other objects on top of this product.

Protect from Exposure to Moisture and Foreign Objects

Do not use this apparatus near water.



WARNING: Avoid electric shock and fire hazard! Do not expose this product to liquids, rain, or moisture.



WARNING: Avoid electric shock and fire hazard! Unplug this product before cleaning. Clean only with a dry cloth. Do not use a liquid cleaner or an aerosol cleaner. Do not use a magnetic/static cleaning device (dust remover) to clean this product.



WARNING: Avoid electric shock and fire hazard! Never push objects through the openings in this product. Foreign objects can cause electrical shorts that can result in electric shock or fire.

Accessories Warning



WARNING: Avoid electric shock and fire hazard! Only use attachments/accessories specified by your service provider or the manufacturer.

Service Warnings



WARNING: Avoid electric shock! Do not open the cover of this product. Opening or removing the cover may expose you to dangerous voltages. If you open the cover, your warranty will be void. This product contains no user-serviceable parts. Refer all servicing to qualified service personnel.

Servicing is required when the apparatus has been damaged in any way, such as a power-supply cord or plug is damaged, liquid has been spilled or objects have fallen into the apparatus, the apparatus has been exposed to rain or moisture, does not operate normally, or has been dropped.

Check Product Safety

Upon completion of any service or repairs to this product, the service technician must perform safety checks to determine that this product is in proper operating condition.

Protect the Product when Moving It

Always disconnect the power source when moving the apparatus or connecting or disconnecting cables.



WARNING: Avoid personal injury and damage to this product! Use only with the cart, stand, tripod, bracket, or table specified by the manufacturer or sold with the apparatus. When a cart is used, use caution when moving the cart / apparatus combination to avoid injury from tip-over.

20070802 Set-Top Cable US & Canada

Welcome to the Explorer 4250HD

Follow the instructions in this guide to install the Explorer® 4250HD™ Home Gateway, to become familiar with the buttons on the front panel, and to access your cable services. Then, enjoy the features of the 4250HD.

Safety First

Before using the 4250HD, read the **IMPORTANT SAFETY INSTRUCTIONS** section of this guide.

For more information about this product, visit our website:

www.scientificatlanta.com/products/consumers/new_cableboxes.htm

Explorer 4250HD Home Gateway Serial Number

To find the serial number for your 4250HD, look on the back for a label that is similar to the example shown here. The serial number begins with SA and is located in the lower left corner of the bar code.

If the 4250HD requires troubleshooting in the future, your cable service provider or Scientific-Atlanta may ask for this serial number.

Use the space provided here to record the 4250HD serial number: _____

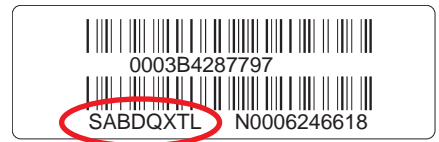

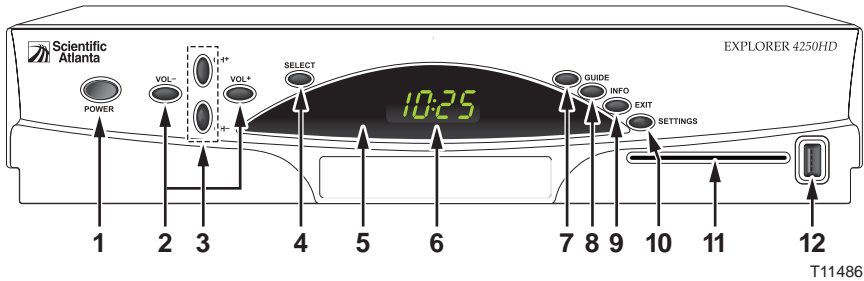

Front Panel Features



T11486

- 1 POWER** Provides power to the 4250HD. A light in the LED display illuminates when the power is on
Note: When not watching TV, turn off the 4250HD to help conserve energy
- 2 VOL-, VOL+** Decreases and increases volume
- 3 CH+, CH-** Scrolls up and down through the channels
- 4 SELECT** Accesses your on-screen selection
- 5 IR Sensor** Receives the infrared signal from the remote control
- 6 LED Display** Displays the selected channel number and time of day. The LED also displays the following:

 - Message ()
 - HDTV
 - Power ()
 - Output Resolution (1080i, 720p, 480p, 480i)
 - AUTO - Automatically outputs native scan rates that your TV can accept
- 7 GUIDE** Accesses on-screen services, such as the on-screen guide, video-on-demand, or pay-per-view
- 8 INFO** Displays a description of the selected program. Available from the on-screen guide and while viewing a program
- 9 EXIT** Exits menus, on-screen guide, and program information
- 10 SETTINGS** Accesses list of recorded programs displayed on the TV screen
- 11 Smart Card Slot** Allows Smart Card access
 (Reserved for future use and may not be available on all 4250HD models)
- 12 USB Port** Connects to external equipment, such as a keyboard
 (Reserved for future use and may not be available on all 4250HD models)

Safety Tip: Keep the top of the 4250HD free of all objects and electronic devices, including your TV.

Back Panel Connectors

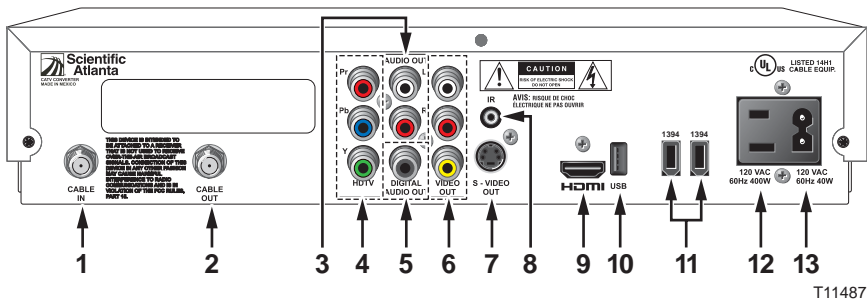

T11487

- 1 Cable In** Connects to the coaxial cable that delivers the signal from your cable service provider
- 2 Cable Out** Connects to a coaxial cable to send analog audio and video signals to a TV or VCR. These signals are standard-definition TV (SDTV) video and stereo audio
- 3 Audio Out (L/R)** Connects to left/right (L/R) audio inputs of TV or A/V receiver
- 4 Y/V Video Out** (HD Component Video Out) Connects to HDTV input of TV (high definition). If you are *not* using the HDMI™ connection, the component video cables (YPbPr) must be connected here to provide HD signals to your HDTV
Note: Do not use these cables if you are using the HDMI connection
- 5 Digital Audio Out** Connects to the coaxial digital audio input of an A/V receiver
- 6 Video Out and Audio Out** Connects to a standard TV or VCR with an RCA cable to send analog video and audio signals to a standard TV or VCR. This signal is SDTV
- 7 S-Video Out** Connects an S-Video cable to send an S-Video signal to your TV or VCR. This signal is standard definition but higher quality than other SD connections
- 8 IR Port** Connects to optional VCR Commander™ service (May not be available on all 4250HD models)
- 9 HDMI** (High-Definition Multimedia Interface) Connects to devices that have an HDMI input, such as a DVD player or a digital television set
- 10 USB Port** Connects to external equipment, such as a keyboard (May not be available on all 4250 models)
- 11 1394** Connects to display devices equipped with a 1394 input (Reserved for future use and may not be available on all 4250HD models)
- 12 AC Outlet** Connects the AC power cord from another device, such as a TV
- 13 AC Power Input** Connects the 4250 to an AC electrical outlet using the cord provided

Connecting the 4250HD

To connect your 4250HD to your entertainment devices, complete these steps.



Determine if your TV is HD or SD and whether it is wide screen (16:9) or standard screen (4:3). **See page 20** for more information.

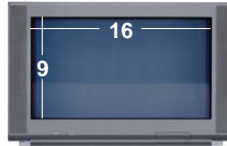

or

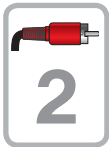

Make the connections for your TV and VCR as follows:

- If you are using an HDTV, **see page 8** for a description of the connectors, and see the end of this guide for connection diagrams.
- If you are using an SDTV, **see page 10** for a description of the connectors, and see the end of this guide for connection diagrams.



Identify the additional devices you will connect to the 4250HD and TV. **See pages 13 through 18** and the related user's guides for more information.

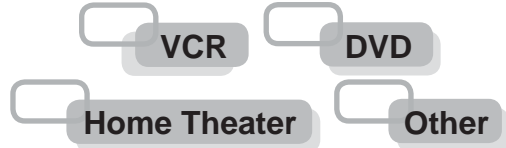

Plug the 4250HD and the TV into an AC power source that is not controlled by a switch.

Important: To protect the set-top from power surge damage, ground (earth) your cable product to provide some protection against voltage surges and built-up static charges. To avoid these voltage surges that can be caused by lightning storms and power outages, plug the set-top into a surge protector to reduce the risk of damage.



Do **not** turn on the 4250HD or TV yet.



It may take several minutes for the 4250HD to receive the latest software, programming, and service information. Wait until one of the following appears on the front panel of the 4250HD to indicate that the update is complete:

- Current time
- Four dashes (- - - -)

Note: If four dashes appear, your 4250HD is not authorized. Call your cable service provider.















Set up your 4250HD for HDTV or SDTV by completing the following steps:

- Make sure the 4250HD is **Off** and the TV is **On**.
- On the front panel of the 4250HD, press **GUIDE** and **INFO** at the same time.
- Follow the on-screen instructions to choose **HD** or **SD** mode and wide screen (16:9) or standard screen (4:3) depending upon your TV type. **See page 20** for more information on the scan rate.

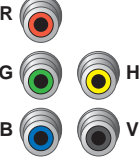

Connections for an HDTV and VCR

To use the 4250HD with an HDTV, you must make **one** of the following connections to view the HD content. Refer to your TV and VCR user's guides and the cabling diagrams in this guide for more detailed connection information. The following table lists the connections in order of performance, beginning with the connection that would yield the best overall performance.

Note: The labeling on your 4250HD may vary from the labels shown in the following table.

Required Connections to an HDTV (choose one)		4250HD Connections	HDTV Connections
HDMI	Some HDTVs have a High-Definition Multimedia Interface (HDMI) connector. The HDMI connector provides both a digital video and audio connection. See page 13 for an example.	 HDMI	 HDMI
DVI	The HDMI connector can provide the connection to an HDTV with a DVI input. If your HDTV has a Digital Visual Interface (DVI) connector, you will need an HDMI-to-DVI adaptor. You will also need to connect a separate audio connection. See page 14 for an example.	 HDMI	 DVI
		Adaptor Needed	
		AUDIO OUT 	AUDIO IN 
PrPbY/V	The PrPbY/V connectors can provide high-definition component video signals to an HDTV. See page 15 for an example. Note: You can use the HD Setup Wizard on the 4250HD to set the HD mode and select the output video format (480i, 480p, 720p, 1080i) that will match the full capabilities of your HDTV.	 Pr Pb Y HDTV	 Pr Pb Y
		AUDIO OUT 	AUDIO IN 
RGB	Some HDTVs have only RGB connectors. If you have one of these HDTVs, you need an RGB adaptor. Check with your cable service provider for information about acquiring an RGB adaptor, or you can purchase the adaptor at your local electronics supplier.	 Pr Pb Y HDTV	 R G B H V
		Adaptor Needed	
		AUDIO OUT 	AUDIO IN 

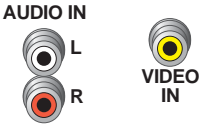
Connections for an HDTV and VCR, continued

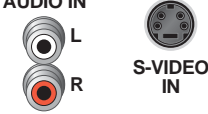
Optional Connections to a VCR (choose one)		4250HD Connections	VCR Connections
VCR	For VCRs that have a Video and Left and Right audio connectors, you can use the Out 2 connectors (Video, Left, and Right) on the 4250HD. See page 16 for an example.		
	For VCRs that have an S-Video and Left and Right audio connectors, you can use the S-Video Out and the Out 2 Left and Right connectors on the 4250HD.		

Connections for a Standard-Definition TV and VCR

To use the 4250HD with an SDTV, you must make **one** of the following connections to view content. Some SDTVs may not have all these connections. Refer to your TV and VCR user's guides and the cabling diagrams in this guide for more detailed information. The following table lists the connections in order of performance, beginning with the connection that would yield the best overall performance.

Note: The labeling on your 4250HD may vary from the labels shown in the following table.

Required Connections to an SDTV (choose one)		4250HD Connections	SDTV Connections
PrPbY/V	<p>The PrPbY/V connectors can provide standard-definition component video signals to an SDTV. See page 18 for an example.</p> <p>Note: To connect PrPbY/V to an SDTV, you must set the HD Setup Wizard on the 4250HD to HD-Mode, and select the output video format (typically only 480i) that will match the capabilities of your SDTV.</p>		
S-Video	<p>The S-Video Out connection provides an optimal video connection to SDTVs.</p>		
Composite	<p>When you set up the 4250HD in SD mode, the Y/V connector on the 4250HD is configured as a composite video out connector (V). See page 18 for an example.</p>		
Cable Out	<p>The Cable Out connector provides a video and audio connection to an SDTV.</p>		
Optional Connection to a VCR		4250HD Connections	VCR Connections
VCR	<p>For VCRs that have a Video and Left and Right audio connectors, you can use the Out 2 connectors (Video, Left, and Right) on the 4250HD.</p>		

Performance Tips

If the 4250HD does not perform as expected, the following tips may help. If you need further assistance, contact your cable service provider.

No Picture

- Verify that the power to your TV is turned on.
- If the 4250HD is plugged into a wall switch, verify the wall switch is in the ON position.
Note: You should avoid plugging the 4250HD into an outlet that is controlled by a wall switch.
- Verify that all cables are properly connected.
- If your system includes a VCR or stereo, verify that you have properly connected them to the 4250HD.
- Verify that the 4250HD is set to the proper screen type and resolution.
- The current channel may not be available in your service package. Try selecting another channel to see if video is available.

No Color

- Verify that the current TV program is broadcast in color.
- Adjust the TV color controls.
- If you are using a component video connection (PrPbY/V), check that all connectors are completely plugged into the 4250HD and TV.

No Sound

- If your setup includes a VCR or stereo, verify that you have properly connected it to the 4250HD.
- Verify that the volume is turned up.
- Verify that the mute function is not engaged.
- Check your secondary audio programming (SAP) settings.

Automatic Software Updates

The TV screen displays a message that indicates the 4250HD is automatically updating its software. Wait for the current time to appear on the front panel of your 4250HD before continuing. When the time appears, the update is complete.

Watching TV

Access Services and Programs

Access cable services and programs by pressing the following keys on the remote control:

- **Guide** – Access the on-screen guide. The on-screen guide displays schedules of TV programs and other services available from your cable service provider, such as video-on-demand and pay-per-view programs.
- **Arrows** – Highlight a program in the schedule.
- **Info** – Display a specific program description (either from the on-screen guide or while viewing a program).
- **Select** – View a specific program in the guide.

Avoid Screen Burn-In

Images such as letterbox bars or side bars, bright closed-captioning backgrounds, station logos, or any other stationary images may cause the picture tubes in your HDTV to age unevenly and cause damage to your HDTV. Refer to the user's guide that came with your HDTV for more information about screen burn-in.



WARNING: To avoid screen burn-in, do not display the same fixed images on your HDTV screen for extended periods of time.

Connection Diagrams

Connecting the 4250HD to an HDTV With an HDMI Connector

 **WARNING:** Electric shock hazard! Unplug all electronic devices before connecting or disconnecting any device cables for the 4250HD.

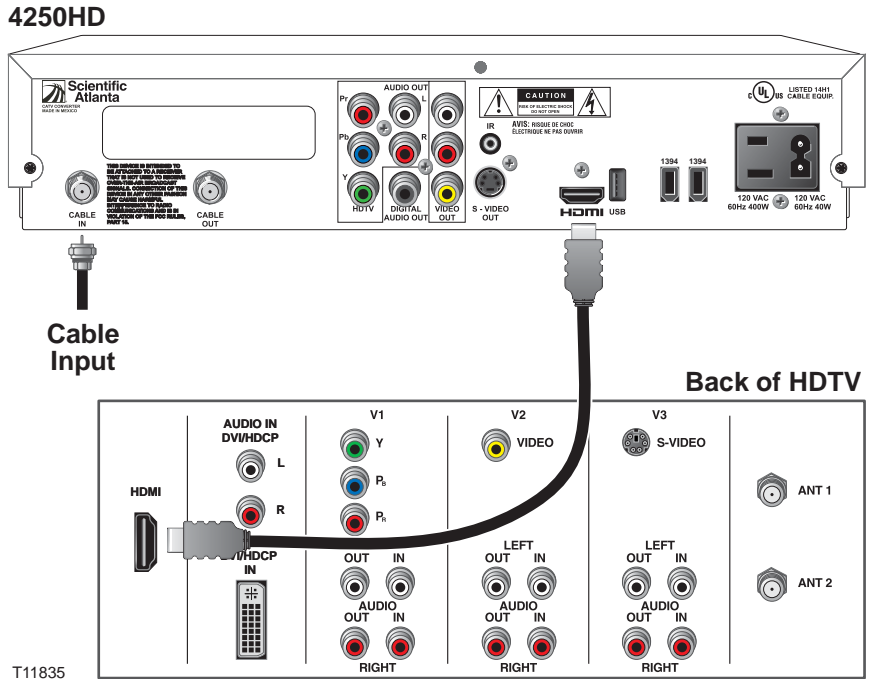

Important Note Regarding the HDMI Interface on the 4250HD

The HDMI interface will automatically configure the audio output for a format supported by the television. Because not all TVs support a Dolby Digital™ input, the HDMI interface may automatically select a 2-channel stereo audio configuration instead of Dolby Digital. When the output is configured for 2-channel audio, this configuration is carried over to the other digital audio outputs of the 4250HD. This configuration prevents your home theater system or Dolby Digital decoder from providing the full Dolby Digital surround sound effect.

On the 4250HD, you may override the automatic selection of audio by the HDMI interface by completing the following steps.

1. Press **SETTINGS** twice on the remote control to open the General Settings menu.
2. Press **MOVE UP** or **MOVE DOWN** to select the option Audio: Digital Out.
3. Press **MOVE RIGHT** to select Dolby Digital. This setting will send Dolby Digital audio to the HDMI, DIGITAL AUDIO OUT, and OPTICAL AUDIO OUT connectors on the 4250HD.

Note: If the TV (video/audio monitor) connected to the 4250HD using HDMI is not Dolby Digital capable, it may not produce audio through its speakers when the Audio: Digital Out setting on the 4250HD is set to Dolby Digital. You can either switch the Audio: Digital Out setting back to HDMI when you are not using the home theater or Dolby Digital decoder, or you can connect the baseband audio outputs (OUT 1 Audio Left and Right) to the TV.

Connecting the 4250HD to an HDTV With a DVI Connector



WARNING: Electric shock hazard! Unplug all electronic devices before connecting or disconnecting any device cables for the 4250HD.

4250HD

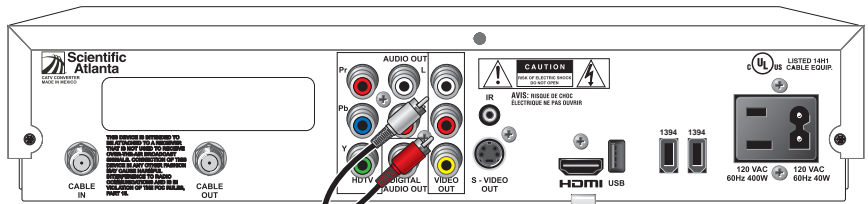

Cable Input

Back of HDTV

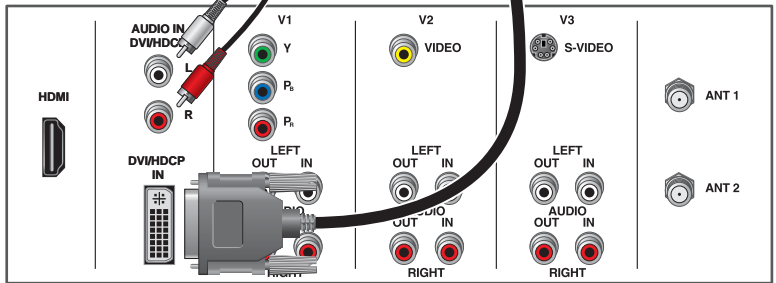

T11837

Note: When connecting the HDMI connector to the DVI connector on your HDTV, you need an HDMI-to-DVI adaptor. You also need a separate audio connection for the left/right analog ports or the digital audio out, whichever matches the input formats that your TV accepts.

Connecting the 4250HD to an HDTV With Component Input (PrPbY/V)

⚡ WARNING: Electric shock hazard! Unplug all electronic devices before connecting or disconnecting any device cables for the 4250HD.

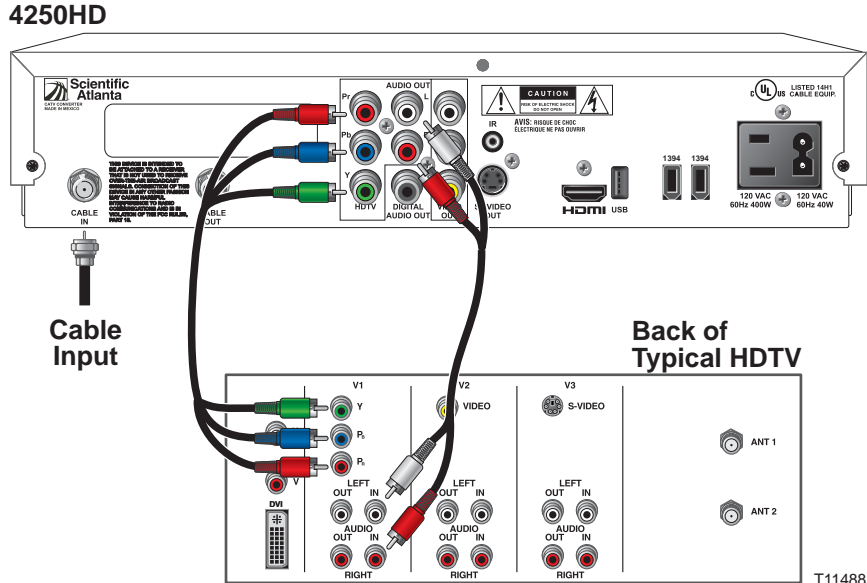

T11488

Connecting the 4250HD to a Home Theater System With Component Input (PrPbY/V)

WARNING: Electric shock hazard! Unplug all electronic devices before connecting or disconnecting any device cables for the 4250HD.

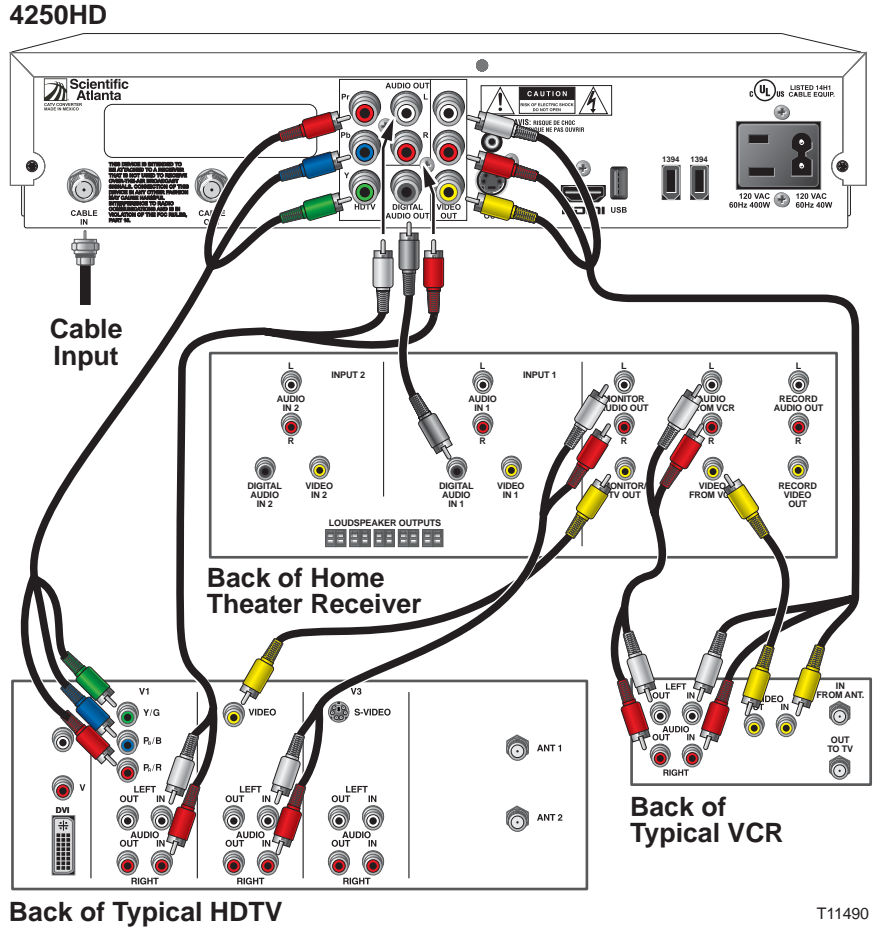

Note: This connection assumes that audio is provided by the home theater speakers.

Connecting the 4250HD to a Stereo VCR, DVD Player, and HDTV (optional)

WARNING: Electric shock hazard! Unplug all electronic devices before connecting or disconnecting any device cables for the 4250HD.

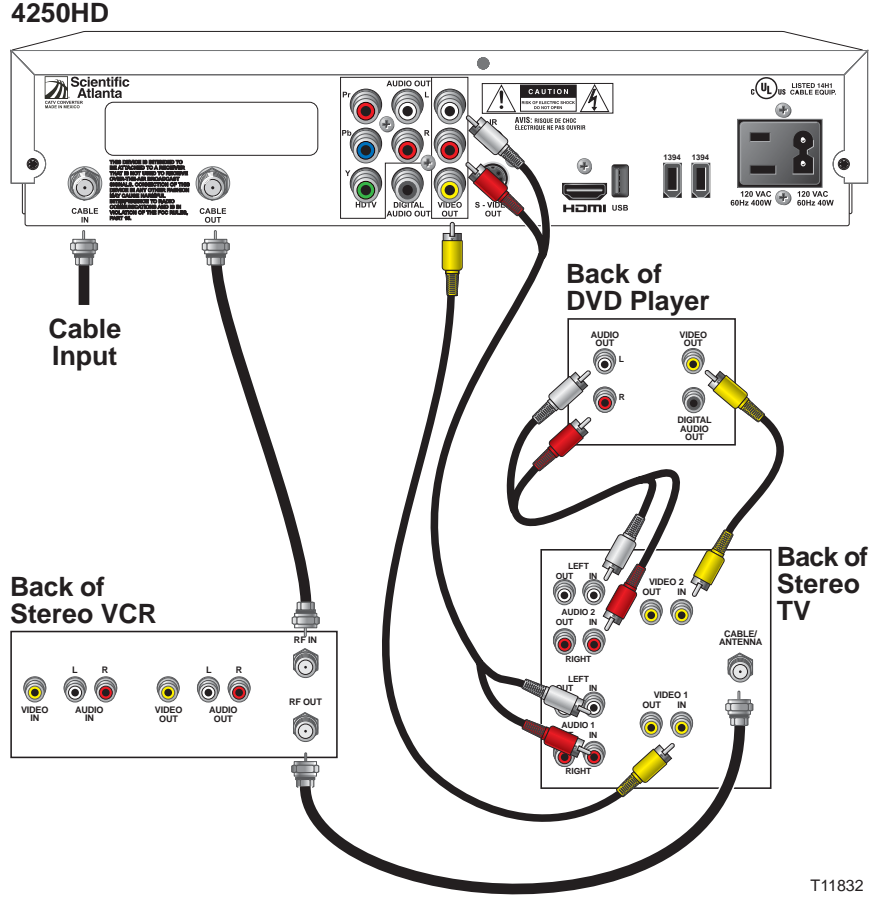

T11832

Connecting the 4250HD in HD Mode to an SDTV With Component Input (PrPbY/V)

4250HD Set to HD Mode

WARNING: Electric shock hazard! Unplug all electronic devices before connecting or disconnecting any device cables for the 4250HD.

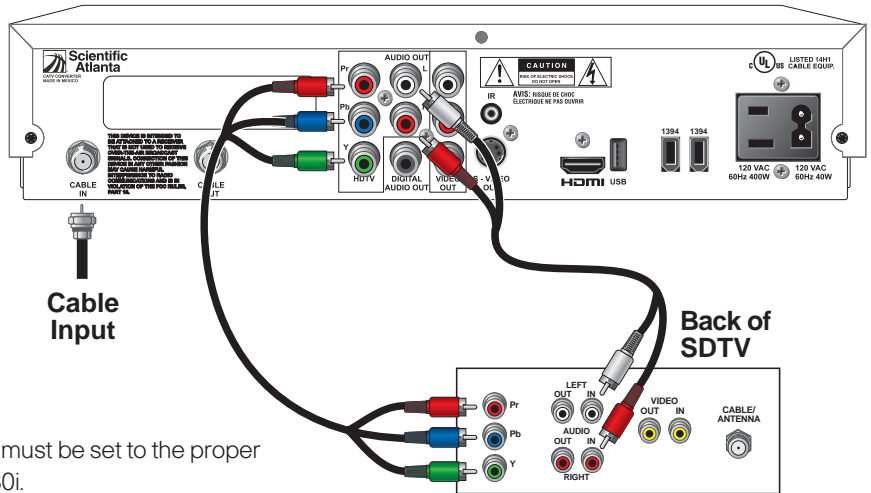

Note: Note: The 4250HD must be set to the proper output mode, typically 480i.

T11836

Connecting the 4250HD in SD Mode to an SDTV

4250HD Set to SD Mode

WARNING: Electric shock hazard! Unplug all electronic devices before connecting or disconnecting any device cables for the 4250HD.

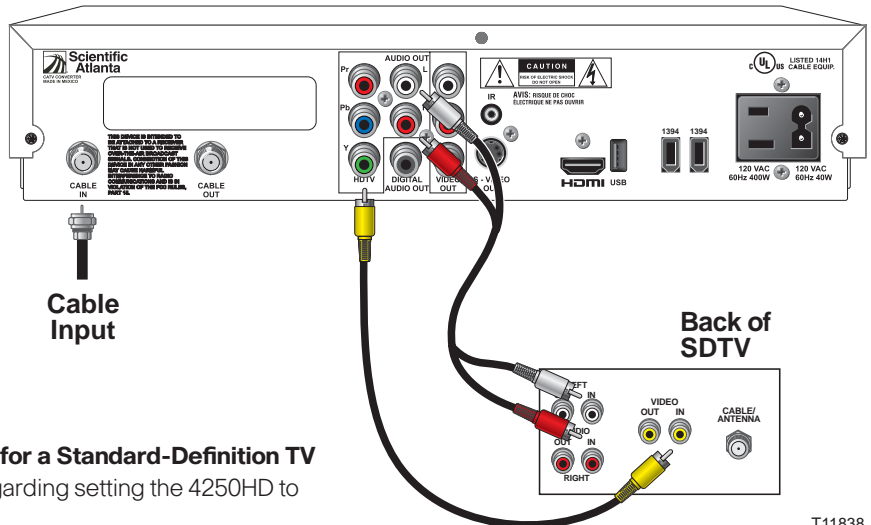

Note: See **Connections for a Standard-Definition TV and VCR** on page 10 regarding setting the 4250HD to SD mode.

T11838

Frequently Asked Questions About HDTV and Digital TV

What is Digital Television?

Digital television (DTV) is a huge leap forward in television technology compared to analog television that has been widely available since the 1940s. DTV is delivered and displayed using digital encoding, similar to the way a PC operates. By using digital technology, there is no variation in picture and sound quality from the origination point until it is displayed on your television. You always receive a high-quality picture without the wavy lines or static you might sometimes get from a weak analog signal.

Because DTV receives and displays digital images that contain many times more picture elements (pixels – the small dots that make up the color image on your screen) than standard analog television, you can get a sharper on-screen image than with analog. Additionally, DTV supports CD-quality sound. DTV includes SDTV (Standard Definition Television), EDTV (Enhanced Definition Television), and HDTV (High-Definition Television). That means that all HDTV is digital, but not all digital TV is high-definition. A high-definition program must originate in HD format and be broadcast in HD format. Simply having an HDTV system does not mean that everything you watch will be in high-definition.

What is Standard-Definition Television?

Standard-definition television (SDTV) is basic digital television programming delivered by cable. Typically, the SDTV screen is the same, nearly square shape as an analog television screen. Digital images on an SDTV set are crisp and clear—noticeably better than on a standard analog television set using an antenna to receive over-the-air signals or on a cable-ready TV connected without a digital set-top.

What is High-Definition Television?

High-definition television (HDTV) is a completely new way to send and receive television broadcast signals. HDTV images are made up of pixels that are much smaller and closer together than those used in standard analog television, and there are millions of them. Thus, HDTV can display five to six times the detail of analog television to deliver picture quality that is much more realistic, dimensional, and precise. SDTV programs can be viewed on an HDTV. Another feature of HDTV is digital surround sound using Dolby Digital®, which is the same technology used to produce the sound you hear in movie theaters.

Are Local TV Stations Broadcasting in HDTV?

Many local TV stations are transmitting digital signals. However, transmitting a digital signal does not mean transmitting an HDTV signal. Some stations are using the new bandwidth to broadcast several standard-definition channels. Most stations, once they begin broadcasting in digital, are offering HD content from their parent network (for example, CBS, ABC, NBC, Fox, WB, UPN, and PBS).

Why Are Some HDTVs 4:3 Aspect Ratio and Others 16:9?

The aspect ratios differ because television manufacturers build both standard-screen and wide-screen HDTVs to appeal to consumer viewing preferences.

The two aspect ratios are as follows:

- On wide-screen (16:9) HDTVs, the programming is displayed on the full screen.
- On standard-screen (4:3) HDTVs, the programming is displayed in letterbox format in the middle of the screen. (There are bars surrounding the picture.)

Where Are the Connection Diagrams?

The diagrams on pages 13 through 18 of this guide show examples of common ways to connect the 4250HD to your HDTV, DVD, and home theater receiver. However, these diagrams do not show every possible combination of devices. Refer to the user's guides that came with your other electronic devices for further information.

What Cables Do I Need?

Some of the cables and adaptors shown in the diagrams may not be included with the 4250HD. The required cables are shown in the connection diagrams in this guide.

Picture Formats

What is the Difference Between a Standard-Screen and a Wide-Screen HDTV?

The type of screen your HDTV has (wide screen or standard screen) determines how the 4250HD displays programs on the screen. The picture format for an HDTV is a combination of **aspect ratio** and **screen resolution** and is different for standard-screen and wide-screen HDTVs.

What is Aspect Ratio?

An aspect ratio is the ratio of the width to the height of the TV screen. The aspect ratios differ because the television industry manufactures both standard-screen and wide-screen HDTVs to appeal to consumer viewing preferences.

What is the Screen Resolution and Scan Rate?

The screen resolution indicates the amount of detail that the picture displays. Resolution is identified by the number of display lines on the screen. The techniques that an HDTV uses to "paint" the picture on the screen are referred to as progressive and interlaced. With the **progressive method**, every pixel on the screen is refreshed simultaneously. The **interlace method** involves refreshing pixels in alternation — first the odd lines and then the even lines. For advance setup, select the scan modes that your TV can support. Refer to your HDTV user's guide to choose the proper scan rates (480i, 480p, 720p, 1080i) for your setup. For example, a resolution of 1080i indicates that the screen shows 1080 lines in an interlaced display, and 480p indicates that the screens shows 480 lines in a progressive display.

Note: The screen resolution (1080i, 480p, and so forth) is sometimes referred to as the scan rate. The terms are interchangeable.

A **standard-screen HDTV** has a 4x3 aspect ratio. The screen is 4 units wide for every 3 units tall.

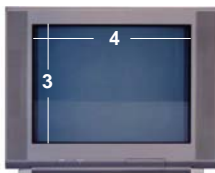

A screen resolution of 480p or 480i fills the screen.

A **wide-screen HDTV** is one-third wider than a standard-screen HDTV. The screen is 16 units wide for every 9 units tall.



A screen resolution of 720p or 1080i fills the screen.

FCC Compliance

United States FCC Compliance

This device has been tested and found to comply with the limits for a Class B digital device, pursuant to part 15 of the FCC Rules. These limits are designed to provide reasonable protection against such interference in a residential installation. This equipment generates, uses, and can radiate radio frequency energy. If not installed and used in accordance with the instructions, it may cause harmful interference to radio communications. However, there is no guarantee that interference will not occur in a particular installation. If this equipment does cause harmful interference to radio or television reception, which can be determined by turning the equipment OFF and ON, the user is encouraged to try to correct the interference by one or more of the following measures:

- Reorient or relocate the receiving antenna.
- Increase the separation between the equipment and receiver.
- Connect the equipment into an outlet on a circuit different from that to which the receiver is connected.
- Consult the cable company or an experienced radio/television technician for help.
- Any changes or modifications not expressly approved by Scientific-Atlanta, Inc., could void the user's authority to operate the equipment.

The information shown in the FCC Declaration of Conformity paragraph below is a requirement of the FCC and is intended to supply you with information regarding the FCC approval of this device. *The phone numbers listed are for FCC-related questions only and not intended for questions regarding the connection or operation for this device. Please contact your cable service provider for any questions you may have regarding the operation or installation of this device.*

FC Declaration of Conformity

This device complies with Part 15 of FCC Rules. Operation is subject to the following two conditions: 1) the device may not cause harmful interference, and 2) the device must accept any interference received, including interference that may cause undesired operation.

Explorer 4250HD Home Gateway
Model: Explorer 4250HD
Scientific-Atlanta, Inc.
5030 Sugarloaf Parkway
Lawrenceville, Georgia 30044 USA
Telephone: 770-236-1077

Canada EMI Regulation

This Class B digital apparatus complies with Canadian ICES-003.

Cet appareil numérique de la class B est conforme à la norme NMB-003 du Canada.

20060628 FCC STD

Macrovision Copyright Notice

This product incorporates copyright protection technology that is protected by U.S. patents and other intellectual property rights. Use of this copyright protection technology must be authorized by Macrovision, and is intended for home and other limited viewing uses only unless otherwise authorized by Macrovision. Reverse engineering or disassembly is prohibited.

Software and Firmware Use

The software described in this document is protected by copyright law and furnished to you under a license agreement. You may only use or copy this software in accordance with the terms of your license agreement.

The firmware in this equipment is protected by copyright law. You may only use the firmware in the equipment in which it is provided. Any reproduction or distribution of this firmware, or any portion of it, without the express written consent of Scientific-Atlanta, Inc. is prohibited.

Disclaimer

Scientific-Atlanta, Inc. assumes no responsibility for errors or omissions that may appear in this guide. Scientific-Atlanta reserves the right to change this guide at any time without notice.



Scientific Atlanta, A Cisco Company

5030 Sugarloaf Parkway,
Box 465447
Lawrenceville, GA 30042

770.236.5000

www.scientificatlanta.com

Scientific Atlanta, the Scientific Atlanta logo, and Explorer are registered trademarks of Scientific-Atlanta, Inc.

4250HD and VCR Commander are trademarks of Scientific-Atlanta, Inc.

Cisco, the Cisco logo, and Cisco Systems are trademarks or registered trademarks of Cisco Systems, Inc. and/or its affiliates in the U.S. and certain other countries.

"Dolby" is a trademark of Dolby Laboratories.

HDMI, the HDMI logo, and High-Definition Multimedia Interface are trademarks or registered trademarks of HDMI Licensing LLC.

Macrovision is a registered trademark of Macrovision Corp.

All other trademarks shown are trademarks of their respective owners.

Product and service availability is subject to change without notice.

© 2007 Scientific-Atlanta, Inc. All rights reserved.

November 2007

Printed in United States of America

4004759 Rev B