



Vax Ltd., Kingswood Road, Hampton Lovett, Droitwich, Worcestershire, WR9 0QH, UK  
email: [info@vax.co.uk](mailto:info@vax.co.uk) - website: [vax.co.uk](http://vax.co.uk)

Version 1.1



# User Guide

Vax Careline: (UK) 0844 412 8455  
(ROI) 1-800 928 308

## Steam Cleaner Home Pro

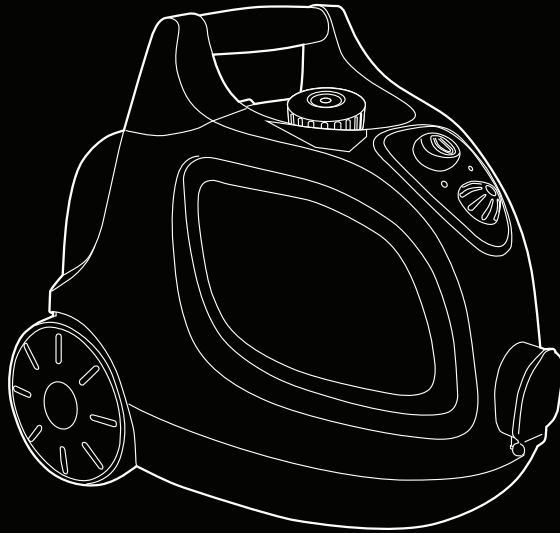

### Get cleaning...

What's your Vax model number? (Located on the flap of the packaging)

e.g. S6S

What's your serial number? (Located on the base of the machine)

Note these down in case you need them in future. Please keep instructions for further use.

# Machine Overview

- 1 Carry handle
- 2 Water tank lid
- 3 On/off button
- 4 Steam ready (green LED)
- 5 Water heating (orange LED)
- 6 Variable steam dial
- 7 Hose inlet
- 8 Tool storage (hidden)
- 9 Steam handle and hose
  - a) Extension tube release
  - b) Safety latch (hidden)
  - c) Steam trigger
  - d) Detergent tank cap
  - e) Detergent control dial (hidden)
- 10 Metal brush
- 11 Detail nozzle
- 12 Small plastic brush
- 13 Large plastic brush
- 14 Scraper tool
- 15 Concentration nozzle
- 16 Window squeegee/upholstery tool
- 17 Velcro microfibre pad (x1)
- 18 Triangular floor head
- 19 Measuring jug
- 20 Funnel
- 21 3pc extension tubes
- 22 Upholstery tool cloth (x2)
- 23 Carpet glider
- 24 Cooling base

## Tool storage

**NOTE:** Items 10-17 are stored onboard at the rear of the unit.

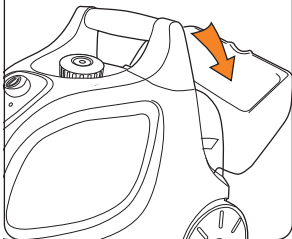

## Unit

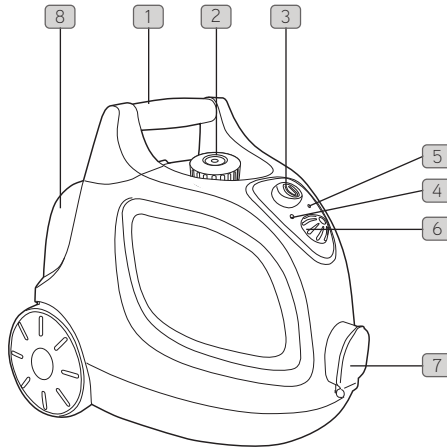

## Accessories

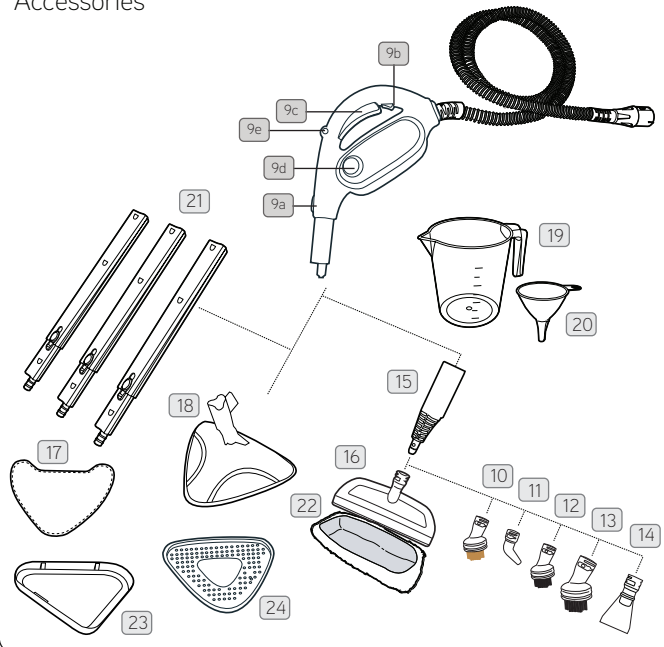

# General Safety Information

## FOR HOUSEHOLD USE ONLY.

When using the steam cleaner, basic safety precautions should always be observed, including the following:

**IMPORTANT:** Please refer to floor manufacturer's care recommendations before use and test the steam mop on a discrete area of flooring to begin with.



**WARNING:** The steam cleaner unit and accessories get very hot during operation.

### DANGER OF SCALDING: Avoid contact with the steam.

1. Do not leave the steam cleaner unattended when plugged in. Unplug it from socket when not in use.
2. To prevent electric shock do not use outdoors.
3. Not to be used as a toy. Close supervision is necessary when used near children or the infirm.
4. This appliance can be used by children aged from 8 years and above and persons with reduced physical sensory or mental capabilities or lack of experience and knowledge if they have been given supervision or instruction concerning use of the appliance in a safe way and understand the hazards involved. Children shall not play with the appliance. Cleaning and user maintenance shall not be made by children without supervision.
5. Use only as described in this manual.
6. Do not use the steam cleaner if it has been dropped, damaged, left outdoors or dropped into water. Do not use the steam cleaner with a damaged cord or plug. If the supply cord is damaged, it must be replaced by the manufacturer or a recommended Service Agent to avoid hazard and invalidating the guarantee.
7. Do not pull or carry by the cord, use the cord as a handle, allow the cord to come into contact with hot or sharp surfaces or close a door on the cord.
8. Do not unplug by pulling on the cord.
9. Do not handle the plug or steam cleaner with wet hands.
10. Do not put any objects into openings or operate with openings blocked.
11. Do not use without the tank cap in place.
12. Turn off all controls before unplugging.
13. Keep the steam cleaner on the floor.
14. Do not use an extension cord.
15. Do not attempt to remove blockages with sharp objects as they may cause damage.
16. Store indoors, put away after use to prevent tripping accidents.
17. Using improper voltage may result in damage to the steam cleaner and possible injury to the user. The correct voltage is listed on the rating label.
18. A hazard may occur if the steam cleaner runs over the power supply cord.
19. The steam cleaner must be kept level during operation.
20. Never immerse the steam cleaner in water or other liquids.
21. Keep the steam cleaner away from rain and moisture. The steam cleaner is not suitable for outdoor use.
22. Do not operate the steam cleaner without water in the tank. Always top up with water in good time.
23. Empty the water tank when the steamer is not in use.
24. Never fill the water tank with anything other than water. Never put additives (such as perfume, stain remover or products containing alcohol) in the water as they may damage the steam cleaner or make it dangerous to use.
25. Always remove the mains plug from the electrical socket and allow this steam cleaner to cool down completely before topping up with water.
26. Do not overfill the tank. Do not exceed the maximum prescribed filling level. Please use the measuring jug and funnel included.
27. Ensure that the water tank cap has been screwed down fully before use.
28. Only carry the steam cleaner by the carry handle.
29. Do not touch any hot areas on the steam cleaner. It is normal for the steam cleaner to heat up during operation.
30. Do not use the steam cleaner to treat any items of clothing that are still being worn on the body.
31. The force and heat of the steam may have an adverse effect on some materials. Always check whether a surface is suitable for treatment with the steam cleaner by carrying out a test beforehand on a concealed area.
32. Always include these operating instructions if passing the steam cleaner on to a third party.
33. Never aim the steam cleaner at people, animals or plants (risk of scalding)! Never touch the steam jet from a short distance with your hands. Do not aim the steam cleaner at electrical systems or wires.
34. Please always switch the appliance off and remove the mains plug from the socket if leaving the work area.
35. The steam cleaner is fitted with a thermostat and a thermal cut-out as protection against overheating.
36. Accessories become hot during use - allow them to cool down before handling.
37. Please ensure all parts are correctly fitted before using the product.
38. Do not use your steam cleaner if damaged/faulty. Please call our Vax Careline on 0844 412 8455.
39. Do not use unit on leather, wax polished furniture or floors, synthetic fabrics, velvet or other delicate steam or water sensitive materials.
40. Do not use on acrylic surfaces.
41. In wet rooms, e.g. bathrooms, connect the appliance to sockets with a series connected RCD adaptor.
42. The device should not be used to clean electrical appliances such as ovens, micro-waves, televisions, and electrical heating systems etc.
43. Be very careful while cleaning tiled walls with sockets

The liquid or steam must not be directed towards equipment containing electrical components, such as the interior of ovens.

**This steamer is for household use only and NOT for commercial or industrial use.**

**PLEASE KEEP INSTRUCTIONS FOR FURTHER USE.**

# Operation

## Assembling your steam cleaner

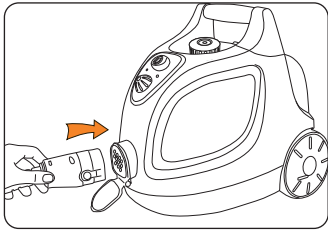

Attach hose to unit.

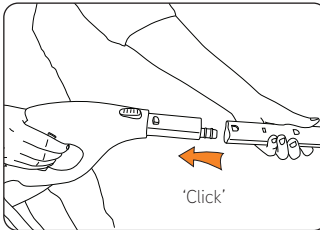

Attach extension tube to handle.

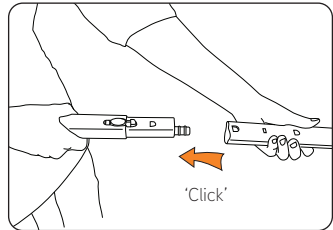

Attach extension tubes together.  
To remove the tube/s press the white release button.

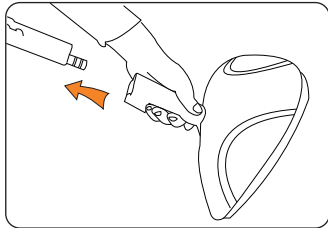

Attach extension tube to triangular floor head.

## Attaching small tools

**IMPORTANT:** Do not attach/remove accessories while steamer is in use.  
(Hot water may drip out of the accessory-risk of scalding)

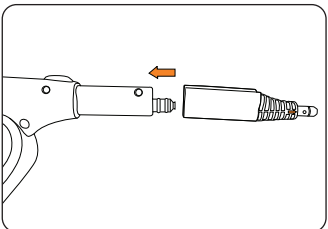

Attach concentration nozzle to handle or extension tube.

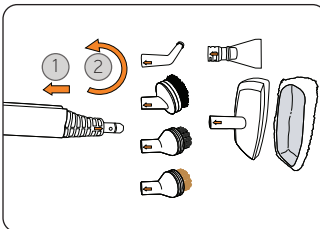

- 1 Push small tools onto concentration nozzle aligning arrows.
- 2 Twist clockwise to fit.

Concentration nozzle must be attached before fitting the small tools.

# Operation

## Attaching the velcro microfibre cleaning pad

For use on sealed hard floors or refreshing carpets.

**WARNING:** To reduce the risk of personal injury, unplug the steamer when fitting the cleaning pads.

**IMPORTANT:** Never use the steam cleaner without a cleaning pad attached to the floor head.

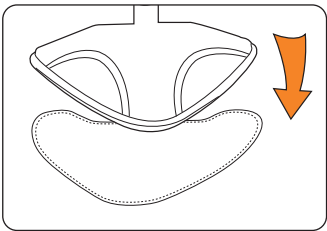

Place the triangular floor head on top of the velcro microfibre pad making sure the mop head covers the entire pad. The blue face should be in contact with the floor.

## Before you begin cleaning

**IMPORTANT:** Your detergent control dial will be set to 'tough stains' when you remove your steamer from the box. If you do not want to use detergent on your hard flooring/hard surfaces, this must be rotated to the 'steam/refreshes carpets only' position. Always test on an inconspicuous area of flooring/surface first before using detergent.

## Filling clean water tank

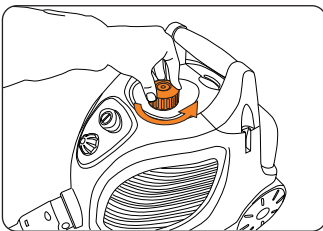

To remove lid, rotate anti-clockwise.

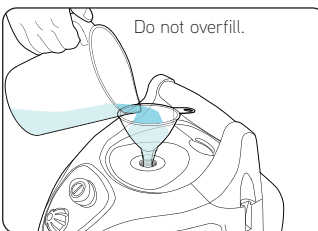

Using the measuring jug and funnel, only fill up to 1.4L. Allow space to be left at the top.

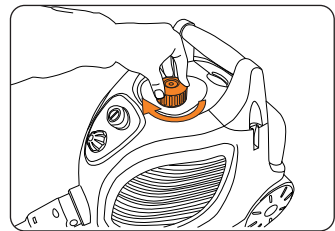

Ensure the lid is securely fastened by rotating clockwise before use.

**IMPORTANT:** Do not use hot or boiling water to fill clean water tank. Do not over fill the water tank.

**IMPORTANT:** Do not operate your steam cleaner without water in the clean water tank.

# Operation

## Filling detergent tank

**IMPORTANT:** Do not mix Vax detergent with any other cleaning detergent. This product can be used with or without detergent.

Detergent tank is located in the hose/handle assembly.

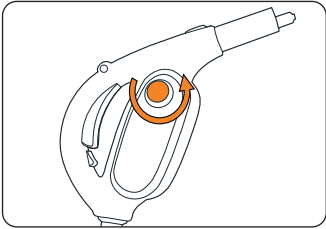

Place the hose/handle assembly on a flat surface. Unscrew the detergent tank cap by turning anti-clockwise.

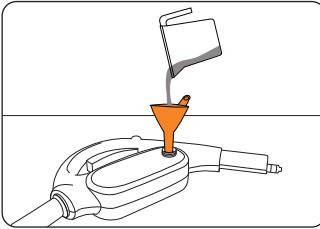

Pour 50ml of Vax detergent and 150ml of water using the measuring jug, into the detergent tank. Attach the detergent tank cap and tighten by twisting clockwise.\*

50ml detergent plus 150ml water to 1 clean water tank.

## Refilling water during operation

**IMPORTANT:** Turn off the steamer and unplug from electrical socket before filling up the clean water tank.

**NOTE:** Wait 10 minutes until the safety pressure indicator has gone down, which indicates the steamer has cooled. If after this time the indicator has not fully dropped, release residual steam pressure by pressing steam trigger on handle and then gently pushing the safety pressure indicator. Slowly unscrew the tank lid anti-clockwise but do not remove. Allow steamer to cool an additional 5 minutes. After you have ensured steamer has cooled and pressure has been released the water tank lid should turn freely to remove. Remove any remaining water to avoid overfilling. Return to 'filling clean water tank'.

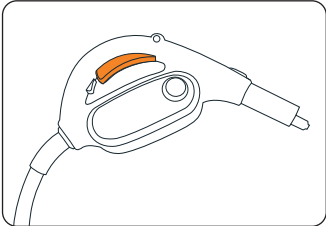

Press steam trigger to release pressure.

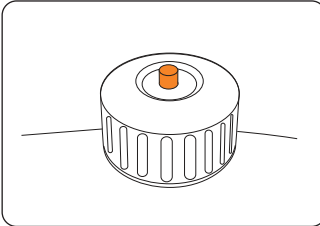

When tank is under pressure, the safety pressure indicator (red) will rise above the surface of the lid.

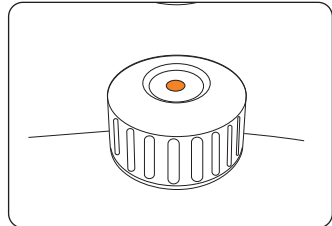

When the tank is not under pressure, the indicator will be flush or below the surface.

# Operation

## Steam cleaning hard floors

**WARNING:** Never leave the steam cleaner floor head in one spot on any surface for an extended period of time with a damp or wet pad attached as this may damage the floor surface. Your steam cleaner should only be used on sealed floors including tiles, lino, wood flooring and laminate.

**WARNING:** To reduce the risk of personal injury, unplug the steam cleaner when assembling the accessories.

Do not operate the steam cleaner without water in the clean water tank.

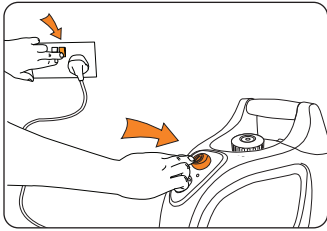

Plug into mains, turn on and press power button on.

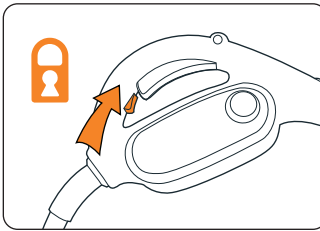

Ensure steam handle safety latch is on.

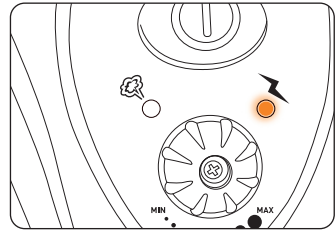

Orange LED will illuminate when water is heating.

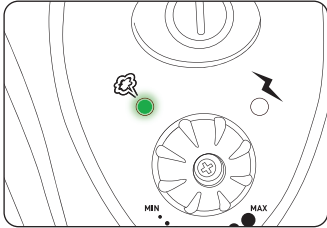

After approximately 12 minutes the Green LED will illuminate showing steamer is ready to use.

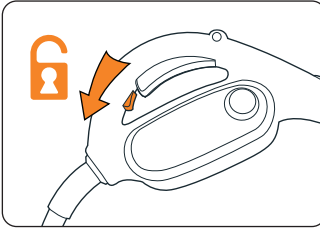

Release steam handle safety latch.

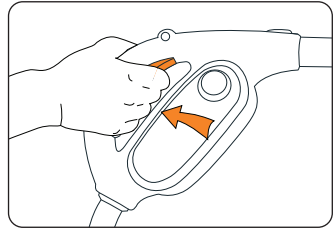

To produce steam, squeeze the trigger in short bursts. To prevent overly wetting floors, do not hold down continuously.

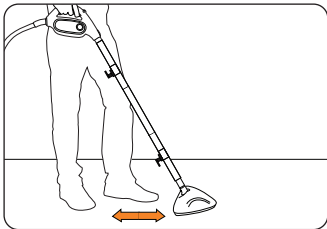

When cleaning sealed hard floors, move the steamer slowly backwards and forwards paying particular attention to high traffic areas. Squeeze/release trigger as required.

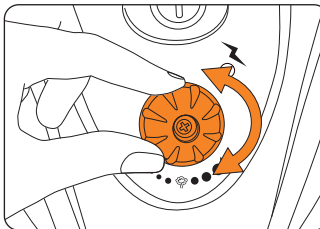

Rotate variable steam dial to adjust pressure.

1 x 1.4L water tank =  
40 minute steaming time (approx)

Orange light = water heating

Green light = steamer ready to use

No green light = water heating to maximum temperature.

(Note: you can still use your steamer at this time).

If during use the green light switches off, this means the steamer is heating up to maximum temperature. The green light will re-appear when it has heated back up to maximum temperature.



# Operation

## To clean with steam detergent

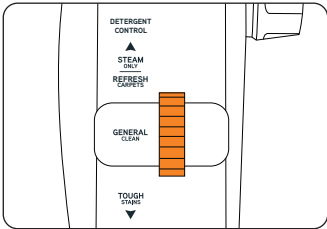

This product can be used with and without detergent. To use with detergent turn the detergent control dial to desired setting for the area you want to clean. Squeeze/release trigger to dispense detergent.

**WARNING:** Only use recommended Vax Steam Detergent.

The detergent can be used on sealed hard floor surfaces and some hard surfaces only. For a full list of surfaces detergent can be used on visit [vax.co.uk](http://vax.co.uk).

## Refreshing carpets

**IMPORTANT:** When using on carpets, always ensure the velcro microfibre cleaning pad is properly attached to the floor head.

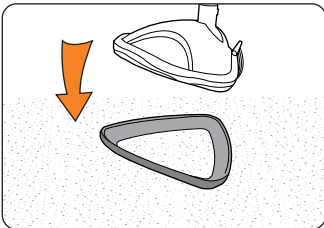

Place floor head (with velcro microfibre pad attached) into carpet glider.

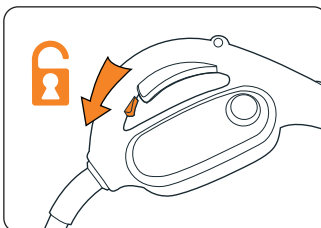

Release steam handle safety latch.

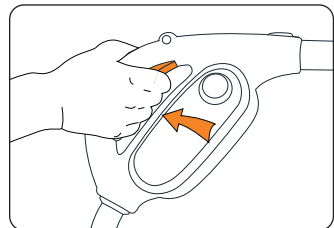

To produce steam, squeeze the trigger in short bursts. To prevent overly wetting, do not hold down continuously.

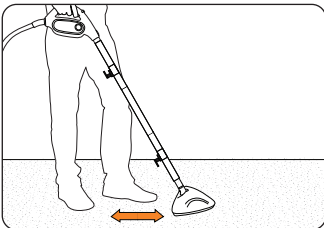

Move the steamer slowly backwards and forwards paying particular attention to high traffic areas.

# Operation

## Using the small tools

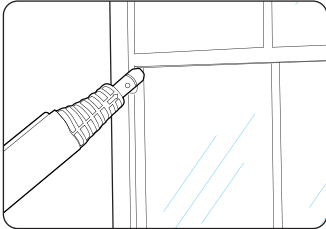

### Concentration nozzle

Use to remove soap scum in baths and shower enclosures and to clean heavily soiled areas in kitchens.

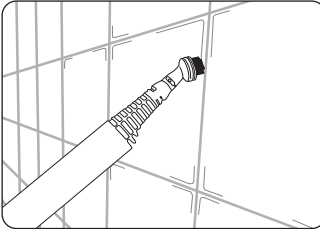

### Brushes

Agitate stubborn grease and grime.

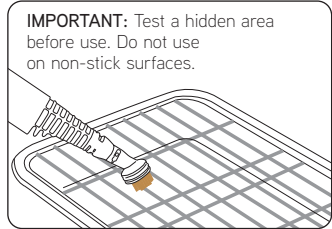

**IMPORTANT:** Test a hidden area before use. Do not use on non-stick surfaces.

### Metal brush

For oven grills and racks.



### Window squeegee tool

Great for leaving your windows, tiles and mirrors gleaming.

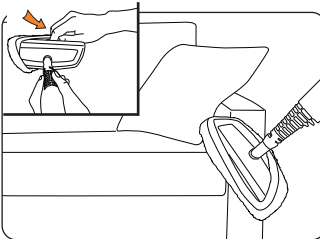

### Upholstery tool

Attach the cloth to the squeegee tool for use on upholstery and clothes. Do not use detergent on fabrics and upholstery.

**IMPORTANT:** Test for colour fastness in a small hidden area of upholstery/fabric to check for colour removal before use.

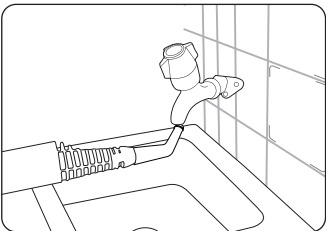

### Detail tool

For hard to reach areas e.g. around taps.

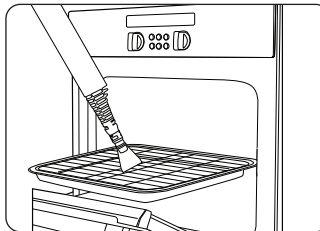

### Scraper tool

Ideal for removing dried on residue from in oven grills, work surfaces and pans.

# Maintenance (Keep your Vax as good as new)

## Emptying the clean water tank

**IMPORTANT:** Allow the unit to fully cool down before performing any maintenance or troubleshooting checks.

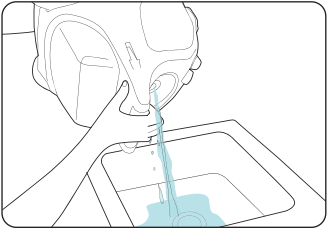

Empty unit of any remaining water.

## Emptying the detergent tank

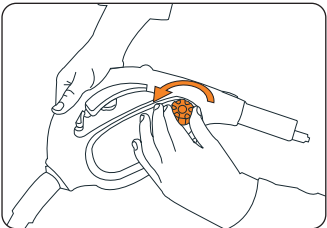

To remove lid, rotate anti-clockwise.

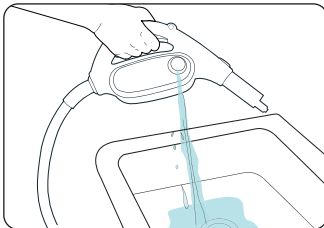

Ensure detergent tank is emptied and rinsed out with tap water after each use.

## Removing the velcro microfibre cleaning pad

**IMPORTANT:** Allow the unit to fully cool down before performing any maintenance or troubleshooting checks.

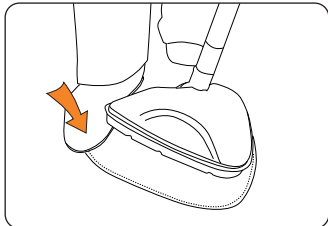

Hold corner of pad down with foot and peel unit away.

# Maintenance (Keep your Vax as good as new)

## Cleaning the pads

**IMPORTANT:** Never use bleach or fabric softener when washing the cleaning pad.

- 1 Machine washable at warm temperature (40°C max). Always use a mild detergent.
- 2 Allow to fully dry before use (24 hours) or tumble dry on a low heat.

## After steamer use/using cooling base/storage

**IMPORTANT:** Steam cleaner must have cooled down before storing.

**IMPORTANT:** To maintain your steam cleaner's performance, turn the unit off at the plug and hold steam trigger down to release remaining steam pressure. Wait for unit to completely cool down before carrying out any maintenance work. Ensure the water tank has been fully emptied and detergent tank rinsed. The unit should be wiped down with a dry cloth before storage.

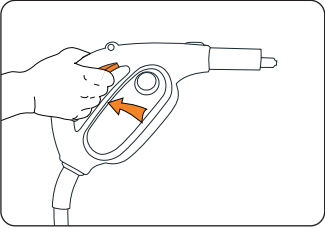

Press steam trigger to release steam.

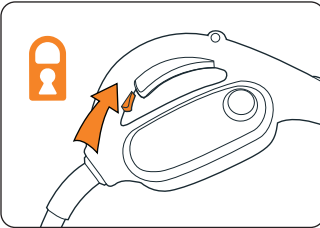

Ensure steam handle safety latch is on.

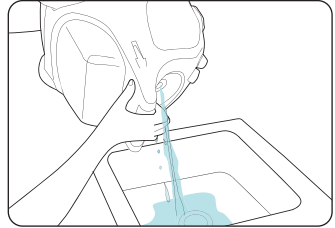

Empty unit of any remaining water.

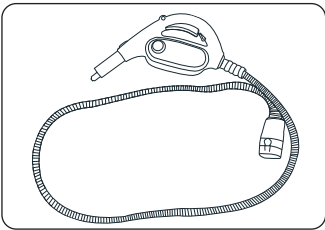

Hose can be hung up or loosely stored in box. Hose must not be tightly wound during storage.

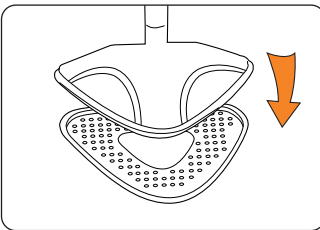

To avoid damage to your floors, unplug the unit and place floor head on cooling base until product cools. Once cooled, remove steamer pad and follow 'cleaning the pads' section.

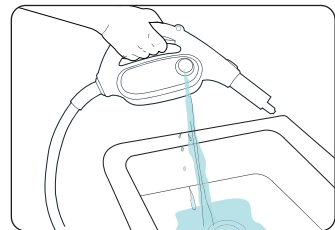

Ensure detergent tank is emptied and rinsed out with tap water before storing your unit.

# FAQs

**WARNING:** to reduce the risk of personal injury, unplug the steamer and ensure unit has fully cooled down before performing maintenance/troubleshooting checks.

## What do I do if the machine/an accessory has become damaged or broken?

- Visit [vax.co.uk](http://vax.co.uk) for spares and parts.
- Please call our Careline to purchase new spares or order a replacement.

## What to do if the steam cleaner has no power?

- The unit may not be plugged into an electrical socket; ensure the plug is pushed in securely.
- Check the mains power is switched on.
- The electrical socket may not be working; check the fuse or breaker and consult an electrician.
- The power cord may be damaged; if it is it must be replaced by the manufacturer, or a Vax authorised service agent.

## Why is the steam cleaner not producing steam?

- Ensure that the mains power is switched on and the power button has been pressed on the unit.
- There may be no water in the tank; please refer to the operation section.
- Check that the safety latch has been unlocked on the steam handle.
- Check that the unit has not been overfilled, as there must be space in the tank for the water to heat. If overfilled the unit will deliver little steam or water droplets.
- The water may not yet be at temperature; the green steam ready indicator light will illuminate when the water is at temperature and is ready to use.
- If the unit is producing a very small amount of steam, check the variable steam power dial and adjust to max.
- If none of the points above are of assistance, we're here to help. Simply call us on: **0844 412 8455**

- When the unit has been switched off and fully cooled remove the water tank lid. If limescale build up can be seen inside the tank the unit will need to be descaled.

## What do I do if the steam cleaner takes a long time to heat up?

- When the unit has been switched off and fully cooled remove the water tank lid. If limescale build up can be seen inside the tank the unit will need to be descaled.
- Otherwise, we're here to help. Simply call us on:  
**0844 412 8455**

**we're here if you need us**

Instead of taking me back to the shop, simply visit;

**[vax.co.uk/support](http://vax.co.uk/support)**  
**[vaxireland.ie](http://vaxireland.ie)**

or call:

(UK) 0844 412 8455  
(ROI) 1-800 928 308

This does not affect your statutory rights.

# Other Information

## UK Service & Help

Any queries or concerns about using your Vax, simply visit; [vax.co.uk/support](http://vax.co.uk/support) - [vaxireland.ie](http://vaxireland.ie) or, call the Vax Careline. Calls are charged at the UK local rate. Please make a note of the serial number and model number of the steam cleaner before calling.

Vax Careline:

(UK) 0844 412 8455

(ROI) 1-800 928 308

Monday-Friday 8.30am to 6.30pm

Saturday 9.00am to 5.00pm

## Consumables

To purchase spares and accessories, please visit [vax.co.uk/support](http://vax.co.uk/support)

The use of genuine Vax spare parts helps to maintain optimised performance and validates your guarantee.

Velcro microfibre cleaning pads (Type 1): 1-1-131448-00

Coral cleaning pad (Type 3): 1-1-131643-00

Vax steam detergent: 1-9-131627-00

Guarantee will only be valid with the use of genuine Vax spares and accessories.



## Technical Specification

Voltage:	220 – 240 v ~ 50Hz
Wattage:	1600W
Water tank capacity:	1.6L (1.4L useable)
Detergent tank capacity:	0.2L
Cord length:	8.0m
Weight:	4.7kg

Subject to technical change without notice.



## EEC Statement of Compliance

Manufacturer/EEC importer: Vax Limited, hereby on our own responsibility, declare that the S6S series is manufactured in compliance with the following Directives:

**Safety:** 2006/95/EC Low Voltage Directive

**EMC:** 2004/108/EC Electromagnetic Compatibility Directive



Waste electrical products should not be disposed of with household waste. Please recycle where facilities exist. Check with your Local Authority or retailer for recycling advice.

# Notes



# Notes

