

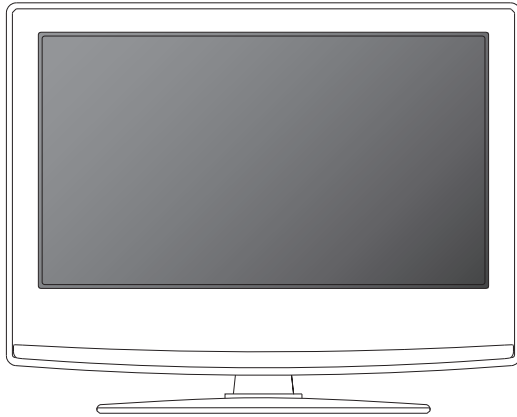

Full HD LED TV with Freeview, DVD Player & USB PVR

## User Guide



Model No

W236-186G-HB-4B-FTCDUP-UK

# Important safety instructions



## Please, read these safety instructions and respect the following warnings before the appliance is operated:

- ✦ This TV with the weight of more than 20 kg must be lifted and carried by at least two people.
- ✦ Be careful! This TV does not contain any parts which could be repaired by the user. In case of a fault, contact the producer or the authorized service. The contact with certain parts inside the appliance might endanger your life. The guarantee is not provided for the faults caused by non-professional interactions!
- ✦ Do not remove the rear part of the appliance.

In order to prevent fire spread, always keep candles and other open flames away from this product.



- ✦ This appliance is designed for receiving and reproduction of video and sound signals. Any other use is strictly forbidden.
- ✦ The ideal distance to watch TV is approximately five times the diagonal of the screen. The light striking upon the screen from other light sources can cause reflections and make the quality of the picture worse.
- ✦ Please, ensure the sufficient ventilation and appropriate distance of the appliance from other pieces of furniture.
- ✦ The TV set is designed exclusively for the operation in a dry place. When using the appliance outside, please, make sure it is protected against moisture (rain, splashing water). Never expose the appliance to moisture.
- ✦ Do not place any containers with water on the appliance, such as vases, etc. These containers might get pushed over, which would endanger electric safety. Place the appliance exclusively on flat and stable surfaces. Do not place any objects such as newspaper or blankets, etc. on or under the appliance.
- ✦ Make sure the appliance does not stand on any power cables as they might get damaged. Mobile phones and other devices such as WLAN adapters, monitoring cameras with wireless signal transmission, etc. might cause electromagnetic interference and they should not be placed near the appliance.
- ✦ Do not place the appliance near heating elements or in a place with direct sunshine as it has a negative effect on cooling of the appliance. Heat storage is dangerous and it

can seriously reduce the lifetime of the appliance. In order to ensure the safety, ask the qualified person to remove the dirt from the appliance.

- ✦ Try to prevent the mains cable or (if it is part of delivery) mains adapter damage. The appliance can only be connected with a supplied mains cable/adaptor.
- ✦ Storms are dangerous for all electric appliances. If the mains or aerial wiring is struck by the lightning, the appliance might get damaged, even if it is turned off. Thus you should disconnect all the cables and connectors of the appliance before the storm.
- ✦ To clean the screen of the appliance use only a damp and soft cloth. Use only clean water, never detergents or in no case dissolvents.

## Warning:

- ✦ Never connect any external devices to a live appliance. Switch off not only the TV but also the devices which are being connected! Plug the appliance plug into the wall outlet after connecting the external devices and the aerial!
- ✦ The product construction responds the protection class 1. Only a properly installed wall outlet with a guard wire (230 V~/50 Hz) of public mains can be used as power source.
- ✦ Always make sure there is free access to the appliance main switch and to its mains plug.
- ✦ The appliance is not designed for a use in a workplace fitted with monitors.
- ✦ The systematic use of headphones at high volume might lead to irreversible hearing damage.
- ✦ Ensure environmental disposal of this appliance and any components including batteries. When in doubt, please, contact your local authority for details of recycling.
- ✦ While installing the appliance, do not forget that furniture surfaces are treated with various varnishes, plastics, etc. or they might be polished. The additions contained in these products might cause destruction of base material of appliance stand. This will result in the holdovers of this material stuck to the furniture surface, which are difficult to remove, if not even impossible.
- ✦ The screen of your TV responds to the top quality requirements and it was checked in details for accidental faulty pixels several times. Due to the technological properties of the manufacturing process, it is not possible to eliminate the existence of a small number of faulty points on the screen for 100% (even with maximum care while production provided). These faulty pixels are not considered faults in terms of guarantee conditions, if their extent is not greater than the boundaries defined by DIN norm.

# Important safety instructions

## Important information regarding use of video games, computers, captions and other fixed image displays.

- ☛ The extended use of fixed image program material can cause a permanent "shadow image" on LCD screen (this is sometimes incorrectly referred to as "burnout to the screen"). This shadow image is then permanently visible on the screen in the back-ground. It is a partly irreversible damage. You can avoid such a damage by respecting the following instructions:
- ☛ Reduce the brightness/contrast setting to a minimum viewing level.
- ☛ Do not display the fixed image for a long period of time. Avoid displaying of:
  - » Teletext time and charts,
  - » TV/DVD menu, e.g. DVD contents,
  - » In the „Pause“ mode (hold): Do not use this mode for a long time, e.g. while watching a DVD or a video.
  - » Turn off the appliance if you are not using it.

## Batteries

- ☛ Observe the correct polarity when inserting the batteries.
- ☛ Do not expose batteries to high temperatures and do not place them on locations where the temperature might increase quickly, e.g. near the fire or on the direct sunshine.
- ☛ Do not expose batteries to excessive radiant heat, do not throw them into the fire, do not disassemble them and do not try to recharge unchargeable batteries. They could leak out or explode.
  - » Never use different batteries together or mix new and old ones.
  - » Dispose of batteries in an environmentally friendly way.
  - » Most of the EU countries regulate the disposal of batteries by law.



## Product disposal

- ☛ Waste electrical products should not be disposed of with household waste. Separate disposal facilities exist. Check with your Local Authority or retailer for recycling advice.



# Contents

---

Important safety instructions .....	4
What is included in the box .....	7
Attaching the Stand .....	8
Detaching the Stand .....	8
Wall mounting the TV .....	8
Getting started - initial set up .....	9
TV buttons & Source menu .....	10
Remote control .....	11
Remote control .....	12
Connections .....	14
TV Menu Operation .....	15
Channel menu .....	15
Picture menu .....	15-16
Sound menu .....	16
Time menu .....	17
Lock menu .....	17
Options menu .....	17
Using the television as a computer monitor .....	18
PC Settings .....	19
7 Day TV Guide / USB Record .....	19
USB Record - Digital mode .....	19
USB mode / Media player .....	20
DVD Menu * .....	21
Frequently asked questions .....	22
Technical specification .....	23
Index .....	24

# What is included in the box

## Accessories

Supply of this TV includes following parts:

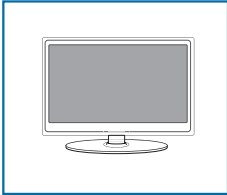

1x TV



1x Stand



1x Remote control



1x RF cable



2x AAA batteries

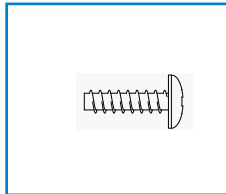

1 x TV stand installation packet

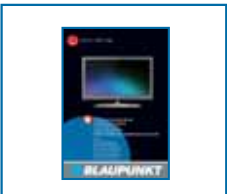

1x User guide



1x Quick Start Guide

Please save your packaging as you will need this in the event of warranty/service repair or support. We are unable to carry out warranty/service if you are unable to package it correctly. The safest way to package your item in the event of warranty/service repair is in its original box/packaging.

# Attaching / Detaching the Stand

## Attaching the Stand

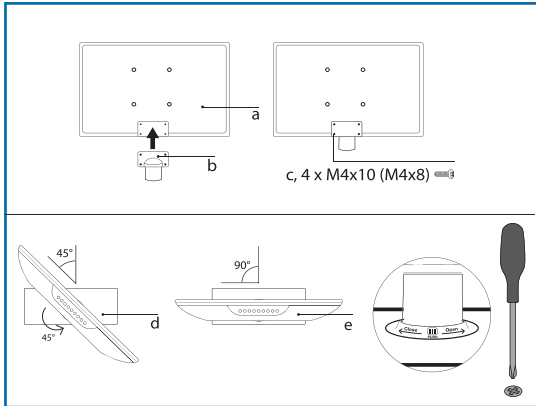

1. Attach the stand neck (b) to the body of TV unit (a) with 4 screws (c)
2. Insert the TV into the stand at 45 degrees (d)
3. Twist the TV into the CLOSE position until it clicks into place (e)

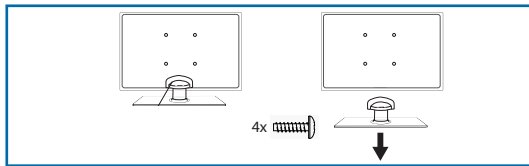

## Detaching the Stand

1. Remove the screws highlighted

## Wall mounting the TV

This television requires a VESA 100 wall mount, or equivalent.

1. Remove the four screws highlighted below.

2. The wall mount can now be easily attached to the mounting holes on the rear of the TV. These holes are indicated in the picture below.

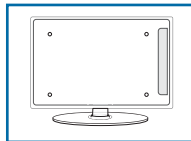

For optimum viewing, if wall mounting the TV higher than eye level, the TV should be tilted downwards so that the TV's screen is 'face on'. See fig 1 and 2

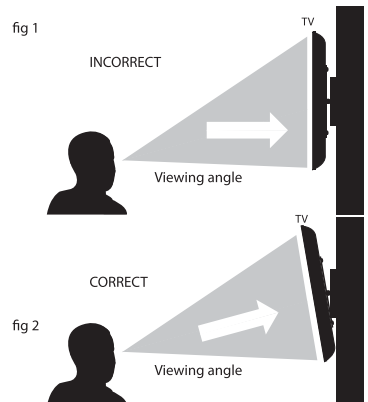

Important - If you mount this television on the wall, use only the screws holes for wall mounting. Using other screws can cause irreparable damage to internal components.

# Getting started - initial set up

1. Using the RF cable supplied, connect the TV to the TV Aerial wall socket (Fig A).
2. Connect the power cable to the Electrical outlet (Fig B).

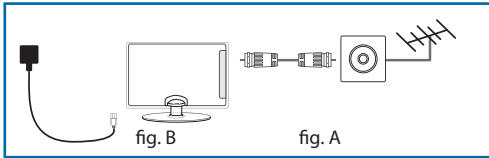

3. Turn on the device with marked ON/OFF switch

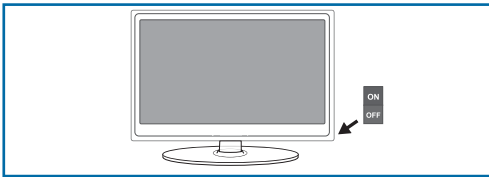

4. Insert the batteries supplied into the Remote control and press the Standby button to power on the TV.

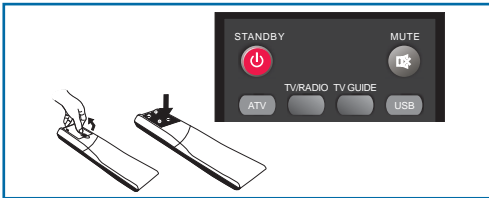

5. You will now be welcomed with the initial set-up screen. If it does not appear, on the remote control, please press [MENU] then 8-8-8-8 and the menu will appear. Press OK on the remote control and tuning will start.



6. After tuning the following screen will appear.

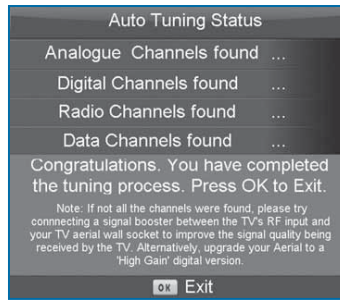

## How to connect a signal booster

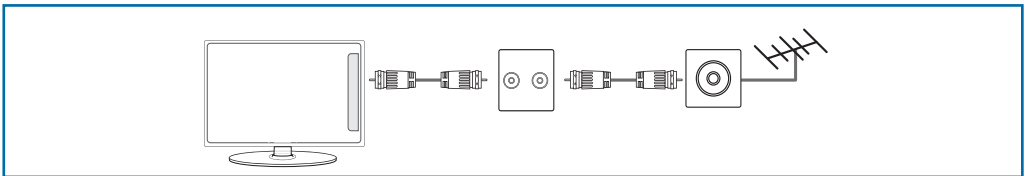

If you are missing channels, the reason for this is likely to be signal strength, you should consider connecting signal booster and re-tuning the TV.

As part of our ongoing development to reduce power consumption, we have added an extra function to this Television called 'Ecohome' (you will see this during the first time installation set up). Power consumption using the Ecohome function is approximately 15% lower than some other modes. The picture brightness is reduced using the Ecohome function. If this function is not suitable for your viewing environment, you can select other modes as necessary. (Please note, 'Professional' mode is for optimum default picture settings, however, power consumption is approximately 15% higher than 'Ecohome' mode) Please refer to the user guide section 'Picture settings' in order to change the mode to one that maybe more suitable for your environment. There is also a shortcut button on the remote control called 'P-Mode' should you wish to change to another mode.

# TV buttons & Source menu

## TV with DVD

1	Eject
2	Play / Pause
3	Volume up and menu right
4	Volume down and menu left
5	Programme/Channel up and menu up
6	Programme/Channel down and menu down
7	Displays Menu/OSD
8	Displays the input source menu
9	Standby Power On/Off

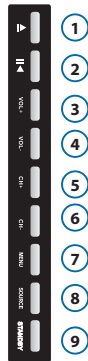
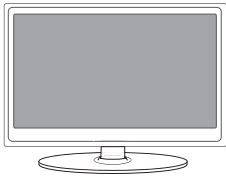

## Choosing Mode Input/Source

To switch between the different input/connections.

a) Using the buttons on the remote control:

1. Press [SOURCE/ AV] - The source menu will appear.
2. Press [▼] or [▲] to select the input you require.
3. Press [OK].

b) Using the buttons on the Television:

1. Press [SOURCE].
2. Scroll up / down using CH+ / CH- buttons to the input/ source you require.
3. Press Vol+ to change input/source to the one selected.

Input Source
FREEVIEW
ANALOGUE
COMPONENT
VGA/PC
DVD
HDMI 1
HDMI 2
VIDEO
USB MEDIA





# Remote control

## TV with DVD

- 1. STANDBY** – Switch on TV when in standby or vice versa.  
**MUTE** – Mute the sound or vice versa.  
**TV/RADIO** – Switch to Digital and switch between TV and radio in Digital mode.  
**TV GUIDE** – Opens the 7 Day TV Guide (Digital mode).  
**ATV** – Switch to analogue TV source.  
**USB** – Switch to USB source.
- 2. REC** – To record what is currently on television.  
**REC LIST** – Opens the list of what you have previously recorded.  
 – To restart the current chapter\*.  
 – To advance forward to the next chapter\*.  
 – To stop the playback\*.  
 – To play in fast rewind mode\*.  
 – To play in fast forward mode\*.  
 – To play/pause  
 \* - Pause live TV when USB Memory Stick is inserted).
- 3. SOURCE/AV** – To display the input/source menu.  
**INFO** – Press once for now/next channel information. Press twice for programme information about current programme.  
**(▲/▼/◀/▶/OK)** – Allows you to navigate the on-screen menus and adjust the system settings to your preference.  
**MENU** – To display OSD menu.  
**EXIT** – To exit all menus.  
**NUMBER BUTTONS – 0 – 9** to select a TV channel directly.  
**↶** – To return to the previous channel viewed.  
**FAV** – To display favourites menu.
- 4. VOL ▲/▼** – To increase / decrease the sound level.  
**SUBTITLE** – To switch the dialogue at the bottom of the screen (on/off).  
**ASPECT** – To switch the screen between the different picture formats.  
**AUDIO** – To change the audio language (if available).  
**SLEEP** – Press repeatedly to cycle through the sleep options.  
**CH ▲/▼** – To increase or decrease the channel being watched.
- 5. GOTO** – DVD mode - To go to a specific chapter  
**A-B** – DVD mode - Press once to set point, press a second time to return to point  
**ANGLE** – DVD mode - Select different angle of DVD (if available)  
**REPEAT** – DVD mode - To repeat playback  
**D.DIS** – DVD mode - To display the current disc information  
**ZOOM** – DVD mode - To zoom in  
**SIZE** – Teletext mode - To change the display size in Teletext mode  
**DISPLAY** – To switch off the screen when listening to radio  
**DVD SETUP/TEXT** – DVD mode - To display the DVD setup menu  
 Teletext mode - To enter Teletext  
**D.MENU/INDEX** – DVD mode - To display the DVD disc menu  
 Teletext mode – To display the index page  
**TITLE/REVEAL** – DVD mode - To display the DVD title menu  
 Teletext mode – To reveal or hide the hidden words.  
**HOLD** - Teletext mode - Hold current page which is displayed



## Connections

1	<b>HDMI 1 in</b>	HDMI input	6	<b>USB</b>	Port USB
2	<b>Video (CVBS)</b>	Video input	7	<b>HDMI 2 in</b>	HDMI input
3	<b>Audio L/R</b>	Audio L/R input for component /video	8	<b>CI Card IN</b>	Common Interface Module Input
4	<b>Mini YPbPr</b>	Component HD Input	9	<b>HEADPHONES</b>	3.5mm Headphone output
5	<b>RF In</b>	RF / TV Aerial Input			

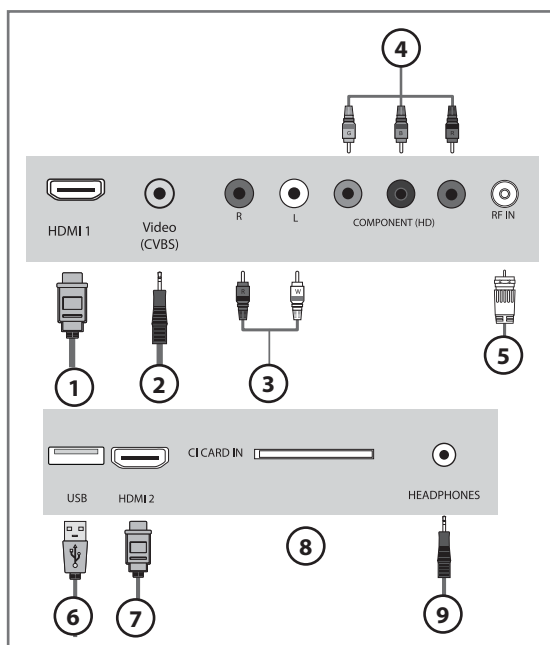

# Connections

## Connecting a DVD Player/Recorder, Video Recorder or Cable/Satellite Box

TVs Input/Source should be set to Video.

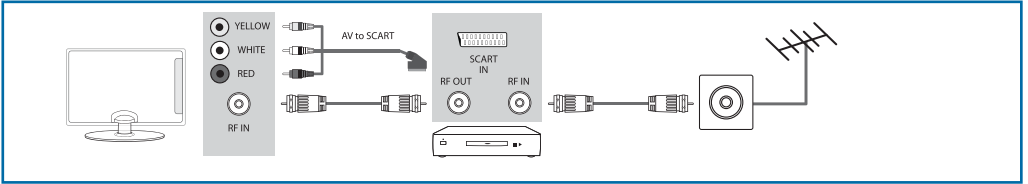

## Connecting a Camcorder, Camera or Games Console

TVs Input / Source should be set to Video.

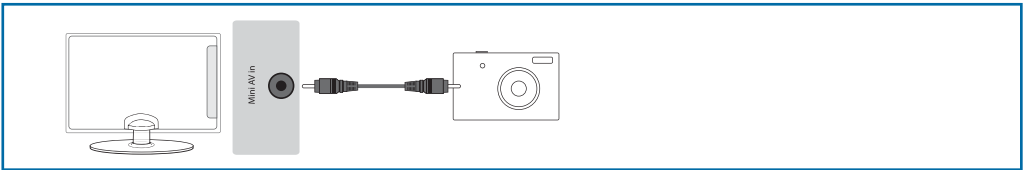

## Connecting a High Definition (HD) Device

Option 1 - via HDMI to HDMI cable

A HDMI cable can output both video and audio and enables you to enjoy digital-quality video and audio with minimal loss of quality.

TVs Input/Source should be set to HDMI.

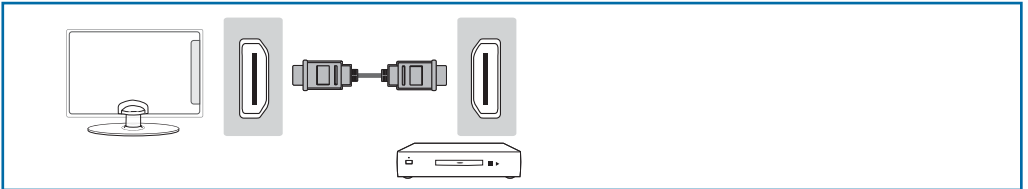

Option 2 - via Component cable.

If you are supplied with a cable from the device which has RED, GREEN, BLUE, RED & WHITE connectors you must use included YPbPr to MINI YPbPr cable adaptor to connect via Component (for picture) and by phono cable (for sound).

TVs Input / Source should be set to Component.

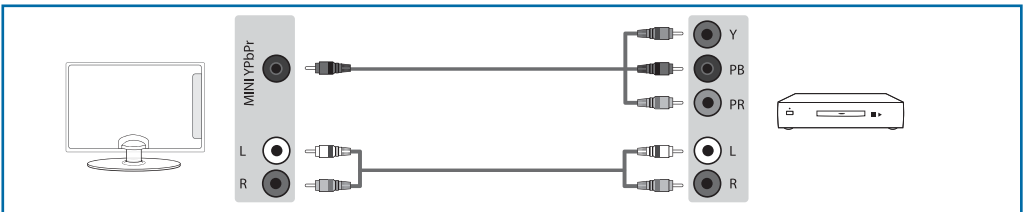

# TV Menu operation

## TV Menu Operation | Channel menu | Picture menu

### TV Menu Operation



To access this menu, press [MENU] button on the remote control. To enter a menu press [OK]  
If you wish to make changes to any of the default settings, use the scroll (▲/▼/◀/▶) buttons. To confirm any settings press [OK] button.

To exit this menu at anytime, press [EXIT] button.

### Channel menu



**Auto Tuning** - Allows you to retune the television for all digital channels, digital radio stations and analogue channels.

**Digital Manual Tuning**- Allows you to manually tune your digital signal.

**Analogue Manual Tuning** - Allows you to manually tune your analogue signal.

**Programme Edit** - Allows you to delete, skip and add favourite channels.



### Picture menu



**Picture Mode** - Choose from the following presets.

Standard	Default settings
Dynamic	Recommended settings for fast moving pictures
Mild	Set to be lighter in colour and less bright
Personal	Lets you manually alter all the settings
Ecohome	Power saving mode

**Contrast** - Switch the balance between black and white.

**Brightness** - Increase or decrease the brightness of the picture.

**Colour** - Increases the colour from black and white.

**Tint** - Lets you increase or decrease the level of tint within the picture.

**Sharpness** - Increase or decrease the sharpness of the picture.

**Colour Temperature** - Choose from the following presets.

Normal	Default settings
Warm	Increases red within the picture
Cool	Increases blue within the picture

**Noise Reduction** - Choose from the following presets.

Off	Turns noise reduction off
Low	Minor system adjustment
Middle	Medium system adjustments
High	Maximum system adjustments
Default	Default settings

Tip: If you do not press any buttons for 10 seconds, the menu will automatically exit. You can change the length of time before the menu exits automatically - see 'Menu Duration' section.

# TV Menu operation

## Picture menu continued | Sound menu

### Picture menu continued

**Aspect Ratio** - Within the EU the picture format varies depending on the channel/broadcast. There are a number of different options to best meet your needs.

**Auto** - Automatically displays the best picture format. So the picture is in the correct position. May have black lines at the top/bottom and/or sides.

**Original** - Will display the picture from the broadcaster without any change.

**Zoom** - The picture is the correct proportion but zoomed in to fill the screen.

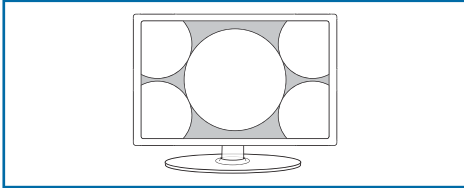

**4:3** - Displays the 4:3 picture in its original size. Side bars are shown to fill the 16:9 screen.

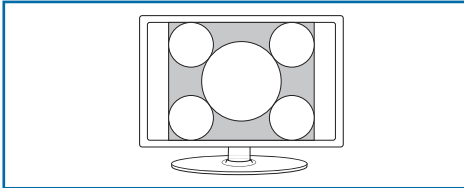

**16:9** - Fills the screen with a regular 16:9 signal and 4:3 picture format will be stretch to fill the screen.

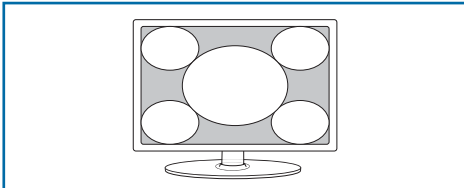

**Panorama** - Displays the 14:9 picture in the correct proportion. As a result side bars are shown on the screen.

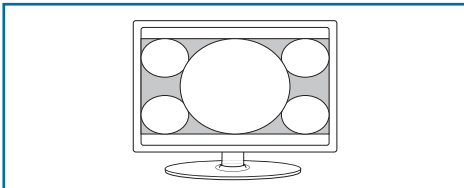

### Sound menu



**Sound Mode** - Choose from the following presets:

Standard	Default settings
Music	Emphasises music over voices
Movie	Provides live and full sound for movies
Personal	Selects your personal sound settings
Sports	Emphasises sound for sports

**Tip:** Treble and bass levels can only be adjusted when the sound mode 'Personal' is selected.

**Treble** - To adjust the amount of high frequency within the sound

**Bass** - To adjust the amount of low frequency within the sound

**Balance** - To switch the sound between the left and right speakers

**Auto Volume Level (AVL)** - When 'on' is selected, the volume will stay at a constant level regardless of **input/source**

**Surround Sound** - Allows you to turn surround sound ON or OFF

**AD Volume** - Increase or decrease the Audio Description volume

**Audio Delay** - Allows you to sync sound and picture on Digital source.

**SPDIF Mode** - This is the digital COAX Audio output. Choose from the following options:

Off	Off
Bitstream	Select this option if you are connecting to a Dolby Digital 5.1 surround sounds amplifier via coax cable (True digital signal)
PCM	Select this option if you are connecting to a Stereo Hi-fi via coax cable (Pulse-code modulation (PCM) is a digital representation of an analogue signal)

# TV Menu operation

## Time menu | Lock menu | Option menu

### Time menu



**Clock** - Set the date and time.

**Off Time** - Allows you to set a specific time for your TV to turn off.

**On Time** - Allows you to set a specific time for your TV to turn on, the channel it will then display, the source it will be on and also the volume. This function can then be toggled to repeat every day or a certain day.

**Time Zone** - Change your current time zone.

**Sleep Timer** - Lets you set the sleep timer so the television automatically switches off after a set amount of time. Off -> 10min -> 20min -> 30min -> 60min -> 90min -> 120min -> 180min -> 240min.

**Auto standby** - Toggle the Function on and off.

### Lock menu

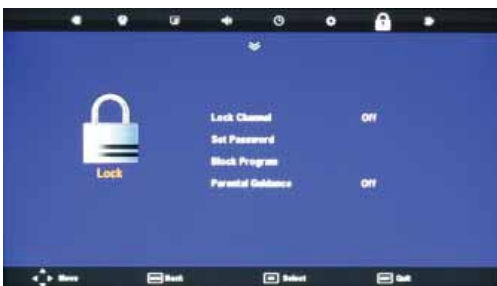

**Lock Channel** - Allows you to lock or unlock specific channels.

**Set Password** - You will be asked to enter a 4 digit password use the ◀ button to quit the password input. Use the ▶ button to clear. Default password is 0000

**Block Program** - Allows to completely block certain channels

**Parental Guidance** - Turns the parental guidance function on and off

### Option Menu



**OSD language** - Allows you to change the language of the menu

**Audio Languages** - In certain situations you will be given the ability to change audio language

**Subtitle Languages** - In certain situations you will be given the ability to change subtitle language

**OSD Duration** - Lets you adjust the amount of time the On Screen Menu stays on the screen before disappearing

**Blue Screen** - Changes the background when there is no input between clear and a blue background (Only available on some sources)

**Country** - Shows you the country that has currently been selected

**Reset Factory default**

**Reset Menu System** - This resets the menus to factory settings.

**Reset Menu System** - This clears all the TV channels from the television

**Software Update (USB)** - From time to time we may release new firmware to improve the operation of the television (available to download). This menu lets you install the new software/firmware onto the television. Further details of how to do this will be issued with the firmware. Contact the helpline or refer to the 'product support' section of the website.

# Using the television as a computer monitor

**IMPORTANT** – Before connecting the computer to the television you must ensure the computer settings are correct for the television. You **MUST** do this using your old monitor.

How to set up for Windows XP, Windows Vista & Windows 7 (connecting via VGA cable to the TV).

1. Switch on your computer.
2. When finished booting up right click your mouse anywhere on the screen.
3. Left click your mouse on Properties/ Personalise.
4. Left click your mouse on Setting/Display Settings. Ensure the screen resolution is set to what is shown in the technical specifications section toward the rear of this user guide. To correct the resolution to that of the television move the slider.
5. Left click your mouse on Advance/Advanced Settings and left click on Monitor.
6. Left click on the drop down for Screen refresh rate and select 60 Hertz, if you experience picture noise or 'flickering', select 50 hertz or 70 hertz.
7. Click on Apply, then click Yes and the settings will be saved.
8. Now switch off your computer and connect the television (as shown).
9. Switch on the TV, select the input/source to VGA/PC and re-start your PC.

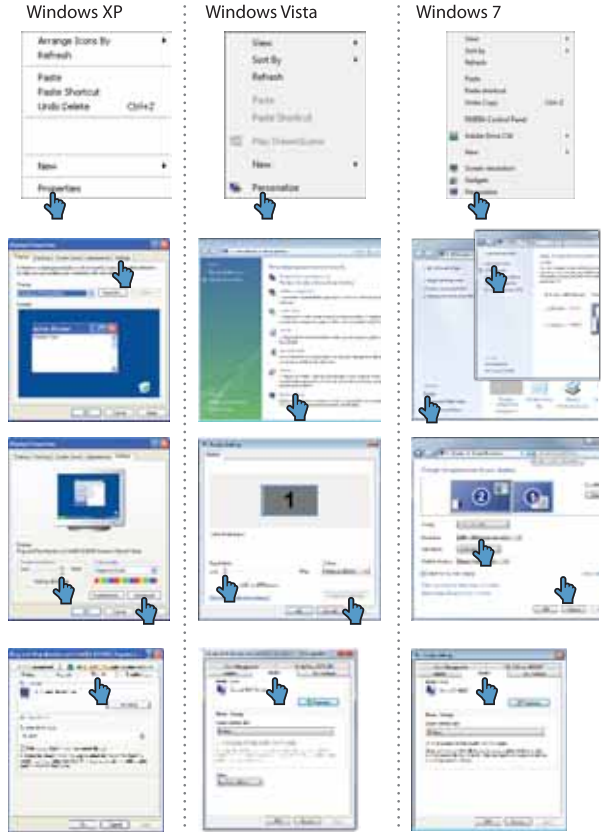

## Connecting a Laptop

In addition to the above if you are connecting a laptop to the television you will also need to activate the VGA connection on the laptop. This can vary based on the brand of laptop you have, on many brands/models, it is as per below.

1. Connect the laptop to the television.
2. On the Laptop push buttons The screen will now switch to the television.

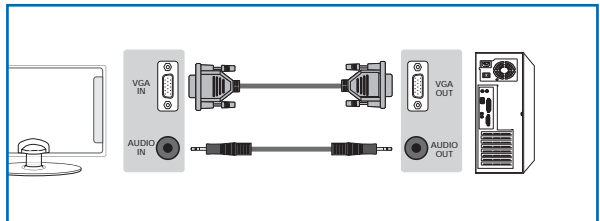



### PC Settings



**Auto Adjust** - Lets you automatically configure the television to be used as a computer monitor.

**H Offset** - Changes the horizontal position of the picture.

**V Offset** - Changes the vertical position of the picture.

**Size** - increase picture size.

**Phase** - To adjust delay time of phase in order to reduce the noise of picture

**Position Reset** - Changes back to the original settings

Tip: If the computer is left in-active for a period of time, the television will switch into a 'sleep' state (the screen will power off to save power). To switch back on press the standby button.

### 7 Day TV Guide / USB Record

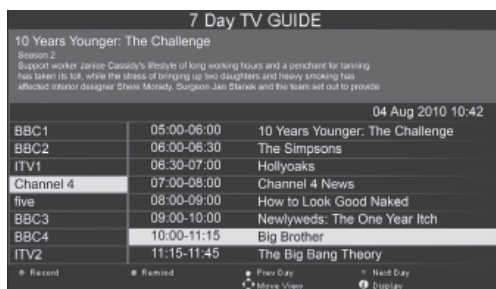

TV Guide is available in Digital TV mode. It provides information about forthcoming programmes (where supported by the Digital channel). You can view the start and end time of all programmes and on all channels for the next 7 days and set reminders.

1. Press [TV GUIDE]. The following 7 Day TV Guide will appear.
2. Navigate through the menu using ▲/▼/◀/▶.
  - You can now:**
    - Record a Programme by pressing RED.
    - Set a reminder by pressing GREEN.
    - View a previous day by pressing YELLOW.
    - View the next day by pressing BLUE.
3. Press [EXIT] to exit the 7 day TV Guide.

Note: This TV is designed to operate with USB memory sticks up to 32GB. It is possible to use either a USB memory stick or a USB portable Hard Drive of a larger capacity, however, it must be formatted to the FAT32 file system in order to operate correctly. At the time of printing this user guide, Windows XP/Vista computers are only capable of formatting up to 32GB, therefore, you will need a software programme/utility to format larger USB drives/hard drives to FAT32. Additional help and support is available from the web site.

### USB Record - Digital mode

USB RECORD – DIGITAL/FREEVIEW MODE

Built into this television is a USB record facility. This function is available in Digital mode when. used in conjunction with a compatible USB memory stick or USB Hard drive. The benefits of this are as follows:

- Pause live TV and then playback, fast forward and rewind (up to live TV).
- One button record, if you decide you want to record the current programme.
- Easy programmable recording from the 7 day TV Guide
- Record TV and watch back on your computer/laptop.

Due to the nature of the product, it is necessary to use a high speed USB memory stick (as the TV reads from and writes to the memory stick at the same time, some memory sticks may not be suitable).

Minimum Specification - USB Memory Stick

Read Speed	20 MB/s (Mega Byte Per Second)
Write Speed	6 MB/s (Mega Byte Per Second)

If you wish to use a USB portable hard drive larger than 32GB, please refer to the FAQ section at the rear of this user guide.

# TV Menu operation

## Pause Live TV (Time Shift) | USB mode / Media player

### Pause Live TV (Time Shift)

Pausing Live TV is very simple.

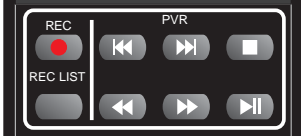

- Ⓜ - Press the play/pause button and the television will pause and the live content will be recorded. To resume watching press play/pause again.
- Ⓜ - Press fast forward to go forward in a recording (i.e. to skip adverts).
- Ⓜ - Press fast rewind to go back in a recording (i.e. if you fast forwarded too far).

Tip: When you switch the TV to standby or change channel the Time Shift memory is wiped. To restart time shift you must press play/pause button.

### One Button Record

At any point in time you may decide to record the current channel that you are watching. To do this you need to press the [REC] button.

Tip: This television contains one TV tuner, therefore it can only record the channel you are watching or record one channel while the television is in standby mode.

Note: USB record function is only available in Digital TV mode. Due to copyright laws and illegal copying/ recording it is not possible to record to/from any other input/output source.

## USB mode / Media player

USB mode offers playback of various different types of content that you have saved on your USB Memory Stick.

Please refer to technical specification page for compatible file types

On switching to USB source the above menu screen will appear. The content will be divided into Photo, Music, Movie and Text based on file type.

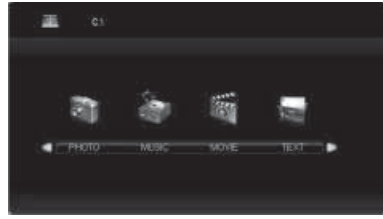

1. You can navigate through the menus using the scroll ▲/▼/◀/▶ buttons. To confirm the item you wish to play/view press [OK] button.

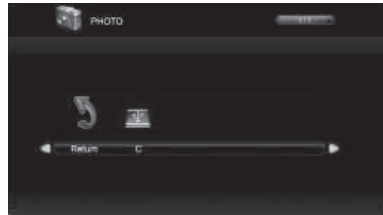

2. Select the drive you require. (If your drive only has 1 partition you will only see 1 item).



3. You can now access the item. Press OK to view.



4. While viewing you control the item using or by

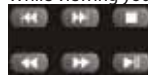

pressing (i) and using ▲/▼/◀/▶ and (OK)

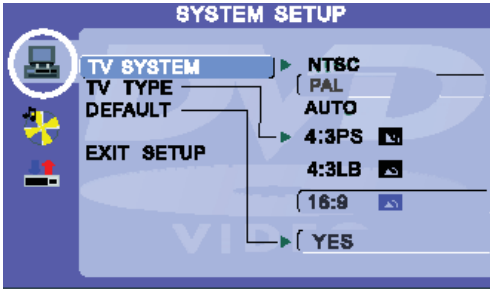

To access this menu, press [MENU] button on the remote control. If you wish to make changes to any of the default settings, use the scroll ▲/▼/◀/▶ buttons. To confirm any settings press [OK] button.

To exit this menu at anytime, press [EXIT] button.

**TV System** - Choose from the following options

<b>NTSC</b>	Normally used for discs from North America, Japan etc
<b>PAL</b>	The standard for discs from UK/Europe, most of Asia, Australia etc
<b>Auto</b>	For both NTSC and PAL

**TV Type** - Choose from the following options

<b>4:3</b>	PS Traditional picture format, often used on old film
<b>4:3</b>	LB Traditional picture which has been adapted for widescreen
<b>16:9</b>	Widescreen picture format

**Default** - This option allows you reset all DVD settings to factory settings.

**Tone** - Choose from the following options

<b>+</b>	Increases the treble (high frequency sound)
<b>-</b>	Increases the bass (low frequency sound)

**Dynamic Range** - This is the difference between the quietest and loudest sounds. This setting works only with DVD discs recorded in Dolby digital.

<b>Full</b>	Set this to listen with the range recorded on the disc
<b>4/8</b>	Set this to listen with a range equivalent to a normal television
<b>2/8</b>	Set this to listen with a smaller difference between the maximum and minimum volume

**Dual Mono**

<b>Stereo</b>	Outputs 2 channels of sound both left and right
<b>Mono L</b>	Outputs left side sound
<b>Mono R</b>	Outputs right side sound
<b>Mix Mono</b>	Outputs a single channel of sound but mix between right and left

# Frequently asked questions

General	I would like to have louder sound by connecting additional speakers.	There are 2 options: 1) Use Digital COAX output connected to an external amplifier/surround sound system. 2) Use the 3.5mm headphone output and a 3.5mm to phono cable (available separately) to connect to an amplifier/surround sound system.
General	Why are some options in the menu unavailable and greyed out.	Some options are only available in certain sources, i.e. HDMI, PC/VGA. They are unavailable in the other sources where they have no affect.
TV	I have tuned in Digital TV but I am not receiving any or all of the channels and/or the channels I receive are breaking up.	1) Check you are in an area that can receive Digital TV . 2) Check you are using an aerial that is able to receive a good digital signal. In most cases, you will need an outdoor digital hi-gain/wideband aerial. In areas that have excellent digital coverage, you may be able to use a loft type aerial but it is highly likely that you will also need to connect a booster between the back of the TV and the TV aerial wall socket. Unfortunately, to receive a good enough digital signal, it is not possible to use a portable/indoor type aerial.
TV	I have re-tuned my television but when I switch it off it is not storing the channels.	Complete a first time installation, please refer to the set-up menu section of the manual of how to do this.
VCR/DVD Recorder	I have connected the TV to my VCR or DVD Recorder via SCART/AV but it is not recording.	In addition to connecting via SCART or AV input, you should connect the aerial cable from the wall socket to your VCR/DVD Recorder and another aerial cable from the VCR/DVD Recorder to the TV.
Game Consoles	I have connected my PS3 to the TV via HDMI, but I am not receiving any pictures or sound on my Television.	1) Ensure the TVs source is on HDMI. 2) Check your settings on your PS3 are as per the PS3 instruction manual.
Game Consoles	I have connected my Xbox 360 to the TV via Component Cables (Red, Green & Blue) but I am not receiving any sound.	Component cables only provide HD Pictures. For the sound you will need to connect the Red & White audio cables on the Xbox to the Red & White phono inputs on the rear of the TV. Please refer to the 'Connections' pages.
USB Mode	I have inserted a USB Memory Key, but the TV does not recognise it.	Ensure the USB Memory Key is formatted to type FAT32.
USB Mode	Using a USB portable hard drive.	If you wish to use a portable hard drive larger than 32GB, please note that it must be formatted to the FAT32 file system in order to operate on this TV. Windows XP/ Vista computers are only capable of formatting up to 32GB, therefore, you will need a software programme/utility to format larger hard drives. Please refer to the web site for more information.
USB Record / TV	I cannot change the channel, access the menu or use the red button.	During Time Shift you cannot change the channel, access the menu or use the red button.
USB Record / TV	When using the USB to record the picture 'breaks up' or experience loss of sound.	Check the USB Memory Stick meet the minimum requirements of Read Speed - 20 MB/s (Mega Byte Per Second), Write Speed - 6 MB/s (Mega Byte Per Second).
System Lock	I have changed the password on the television and now forgotten it.	There is a master password of 4711, to gain access to the TV menu and reset the normal password.

Note: Supplier may change Software Version and On Screen Graphics without warning.

# Technical specification

Model	236/186G-HB-4B-FTCDUP-UK
Screen size (diagonal)	23.6"/60cm
Resolution	1920 x 1080
Contrast Ratio	1000:1
Brightness cd/m2	280
PC RGB	YES
RF	75 ohm- aerial/PAL-SECAM
Video Inputs	2 x HDMI, 1 x USB, 1 x VGA/PC, 1x Composite Video (CVBS), 1x Component (Y,Pb,Pr)
Sound Inputs	1 x L/R Audio shared for Composite/CVBS Video & Component/YPbPR, 1 x 3.5mm jack for PC audio input
Sound Outputs	1 x Output for headphones
USB Port	1
Sound power, watts	2 x 3
Voltage and power consumption	110-240 V 50/60 Hz 25/50W (ecomode/max) - in standby mode less than 0.5 W
Dimensions including stand (mm)	583W x 410H x 195D
Net weight (Kgs)	4.7

# Index

---

7 Day TV Guide / USB Record .....	19	Options menu .....	17
Attaching the Stand .....	8	Sound menu .....	16
Connections .....	13-14	Technical specification .....	23
Detaching the Stand .....	13	Time menu .....	17
Feature menu .....	16	TV buttons & Source menu .....	10
Frequently asked questions .....	22	TV Menu Operation .....	15-21
Getting started - initial set up .....	9	USB mode / Media player .....	20
Important safety instructions .....	4-5	USB Record - Digital mode .....	19
Index .....	24	Using the television as a computer monitor .....	18
Lock menu .....	17	Wall mounting the TV .....	8
PC Settings .....	19	What is included in the box .....	9
Picture menu .....	15-16		
Remote control .....	11-12		









**Universal Media Corporation /Slovakia/ s.r.o.  
Mickiewiczova 7104/14,  
811 07 Bratislava 1, Slovakia  
Assembled in Europe**

