

morphyrichards

Total clean professional fryer



Please read and keep these instructions

UK
 Helpline 0870 060 2613
 Replacement parts 0870 167 6644

Ireland
 1800 409119

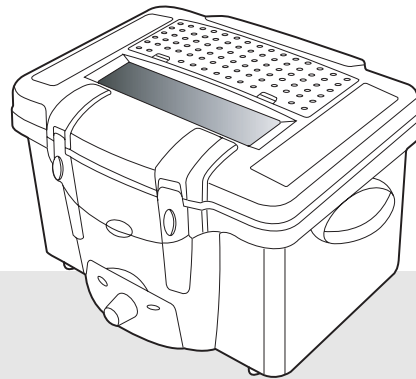

getting the best from your new fryer...

- **Hot oil**

Don't attempt to move the fryer while it is still hot - wait two hours after frying for your fryer to cool.

- **Easy cleaning**

Your fryer breaks down into component parts for easy cleaning with a removable bowl.



2year
guarantee



www.morphyrichards.com

Important safety instructions

The use of any electrical appliance requires the following common sense safety rules.

Primarily there is danger of injury or death and secondly the danger of damage to the appliance. These are indicated in the text by the following two conventions:

WARNING: Danger to the person!

IMPORTANT: Damage to the appliance!

In addition we offer the following safety advice.

Your safety

- **WARNING: Never attempt to move your fryer until it is completely cool. This can take up to three hours. Use the carrying handles.** 
- **WARNING: To protect against the risk of electric shock do not immerse the fryer body in water or other liquid.**
- Unplug from the electrical outlet when not in use and before cleaning. Allow to cool before putting or taking off parts, and before cleaning the appliance.
- Never leave the fryer unattended when connected to the electricity supply.
- Never lean over the fryer when it is in use.
- When opening the lid, stand back as some hot steam may be released.
- Always use oven gloves when removing or replacing lid during use.
- Be careful not to touch those surfaces of the fryer which become hot when in use.

Product safety

- **WARNING: The control pod must never be immersed in water.**
- **WARNING: When unpacking the fryer, make sure all packing material is removed.**
- Never connect the fryer to the electricity supply without oil in the tank.

- Never operate with the oil level below minimum mark (2.0 litres) or above maximum mark (2.7 litres).

Location

- Place the appliance on a horizontal, flat and stable surface away from a heating source and where it cannot be splashed by water.
- Allow adequate air space above and on all sides for air circulation.
- Do not use your fryer under cupboards or shelves.
- Do not use outdoors.

Other safety considerations

- Do not operate any appliance with a damaged cord or plug or after the appliance malfunctions or has been damaged in any manner. Telephone the helpline number (the telephone number can be found on the front cover) for advice on examination and repair.
- Do not use the fryer for anything other than its intended purpose.
- The use of attachments or tools not recommended or sold by Morphy Richards may cause fire, electric shock or injury.
- Always dry food before frying eg. chips which are too wet can cause the hot oil to froth excessively.
- Never pour oil out of the fryer with the bowl in position.

Children

- Never allow a child to operate this appliance. Teach children to be aware of dangers in the kitchen, warn them of the dangers of reaching up to areas where they cannot see properly or should not be reaching.

Scalds

- Run cold water over the affected area immediately. Do not stop to remove clothing, seek medical help immediately.

Mains lead

- The mains lead should reach from the socket to the base unit without straining the connections.
- Do not let the cord hang over the edge of the table or the counter and keep it away from any hot surface.
- Do not let the lead run across an open space eg. between a lower socket and table.

Features

- 1 Spring loaded removable lid
- 2 Lid location guides (not shown)
- 3 Viewing window
- 4 Steam vents
- 5 Lid release button
- 6 Baskets x 3
- 7 Basket handles x 2
- 8 Handle release button
- 9 Basket rest
- 10 Lid lock catch
- 11 Basket handle rest position
- 12 Removable bowl
- 13 Bowl finger lifting lip
- 14 Power on light (red)
- 15 Temperature ready light (green)
- 16 Variable temperature control
- 17 Min and max oil levels inside bowl
- 18 Carrying handles
- 19 Non slip feet on base
- 20 Fryer body

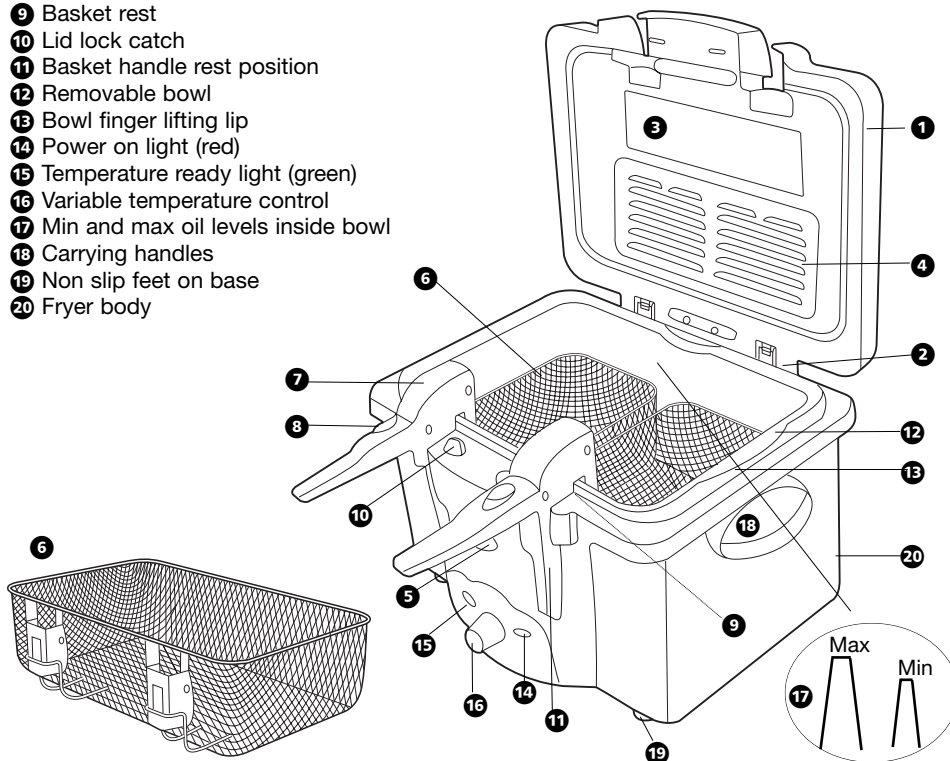

Electrical requirements

Check that the voltage on the rating plate of your appliance corresponds with your house electricity supply which must be A.C. (Alternating current).

If the socket outlets in your home are not suitable for the plug supplied with this appliance the plug should be removed and the appropriate one fitted.

WARNING: The plug removed from the mains lead, if severed must be destroyed as a plug with a bared flexible cord is hazardous if engaged into a live socket outlet.

Should the fuse in the 13 amp plug require changing a 13 amp BS1362 fuse must be fitted.

WARNING: This appliance must be earthed.

Before first use

Refer to the assembly sequence page 5.
When unpacking the fryer, make sure all packaging material is removed.

WARNING: make sure that your fryer is disconnected from the electricity supply.

Please note : Remove the filter from the lid before washing lid.

Remove the frying basket, non stick bowl, lid, body and wash these by hand in hot soapy water. Please note: do not leave in water to soak for a long period of time.

WARNING: Do not immerse the pod in water.

Dry all parts of your fryer thoroughly and replace the, bowl, basket and lid.

Replace the bowl with the max/min lines to the rear. (Please follow the cleaning instructions).

Operation

Lid operation

Press the lid release button, the lid is spring loaded and will rise up on its own.

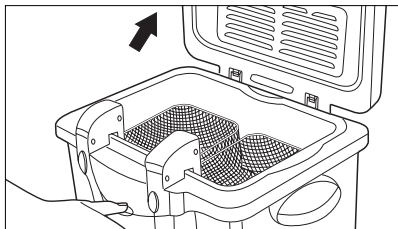

In the upper position the lid will lift out of its guides at the back for easy cleaning.

To replace, locate in the guides and slide back into position.

Close the lid by pressing down in the centre and ensure locking catch 10 is fully engaged.

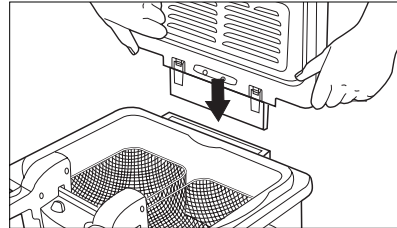

Attaching the handle to a basket

Rest the basket on a level, firm surface, locate the handle into the slots of the basket and pull upwards against the spring force.

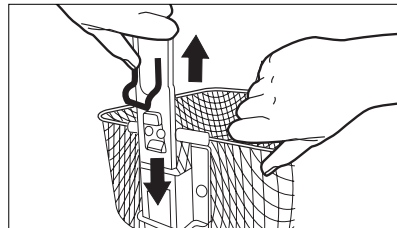

Removal of handles

Rest the basket on a level, firm surface, press the handle down against the spring force and remove.

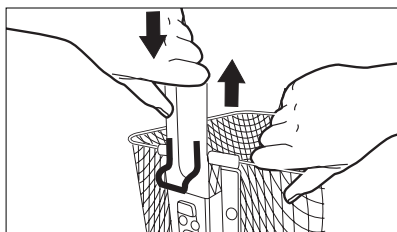

Basket operation

The handles are removable so they can be attached to the 2 small or 1 large basket.

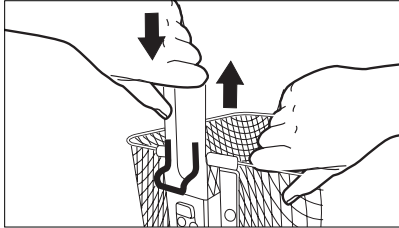

Location of basket to drain

With the lid open and in the vertical position, the basket can be raised into the

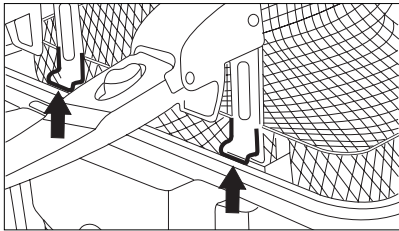

rest draining position or removed completely.

When in the draining position the basket should be hooked on the basket rest lip (shown by the arrow). When lowering the basket back, lift up to remove from the basket rest position, push forward slightly and lower down. Press the basket release button and allow the handle to lower.

When using the large single basket both basket release buttons must be pressed to allow the basket to lower into the oil.

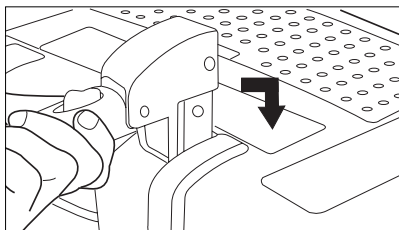

Assembly/Disassembly sequence

The fryer has to be disassembled and assembled following this procedure.

- Open the lid and remove.
- Remove the basket.
- Lift out the tank.
- Pull out the pod control.

Assembly is the reverse of the above process.

Removal of the pod

- 1 Lift up the fryer body at the front as shown and pull out the pod.
- 2 Replace by locating the pod in the guides and push fully in.
- 3 Once the pod is in place route the mains cable to the side or out of the back, whichever is convenient.

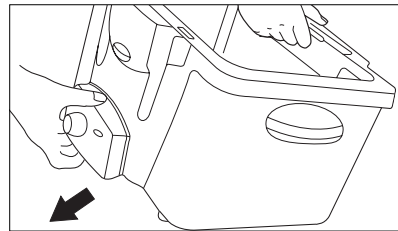

Replacing the bowl

Ensure bowl contacts are dry before replacing.

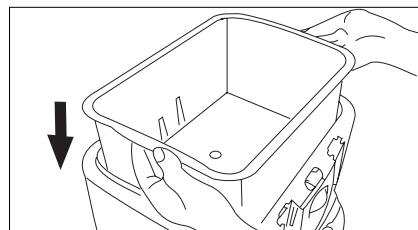

Filter

Press the 2 locking tabs back and lift out the panel. The mesh filter can be left to soak in hot soapy water to clean. Allow to drain and dry before replacing.

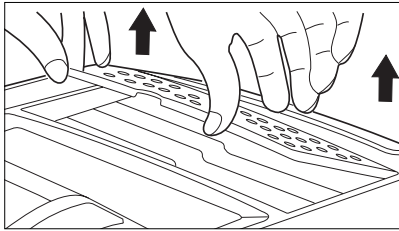

Filling with oil

Pour oil into the tank up to the maximum level indicated (approx 2.7 litres of oil).

Lightly smear the inside of the viewing window with the oil to inhibit any condensation which could reduce visibility.

- Use good quality liquid vegetable oil, see getting the best from your fryer page 7.

Cooking

WARNING: Never operate the fryer without oil in the bowl.

- 1 Lower the basket and close the lid.
- 2 Plug into the mains and switch the power on at the socket and switch on the fryer to position I.
- 3 The red power light and green temperature light will illuminate.
- 4 Set the variable temperature control to the required setting see 'frying times and temperature section'.
- 5 The fryer is now pre-heating the oil, the green temperature light may go out and come back on once or twice during pre-heat. After approx 15 minutes the oil will be at the correct temperature.

- When using small baskets both must be in place when frying to ensure that there is no escape of steam and fumes from the handle opening in the lid.

6 Lift the lid.

- Do not over fill the basket when frying, the food must be covered with the bubbling hot oil, depending on the size and shape of the food to be cooked.

There are two methods of cooking in your fryer, one general method for most food types and another for home battered products.

General cooking method

- 1 Place the basket in the raised position. The basket should always be in the raised position when it is to be filled with food.
- 2 Place the food, which should be dry as possible, into the raised basket. When frying frozen food, avoid adding ice particles to the hot oil. Remove the basket from the fryer, add the frozen food and shake the basket to remove excess ice and frost. The oil temperature and oil life expectancy will be improved.
- 3 Lower the basket onto basket rest **9**.
- 4 Lower the lid.
- 5 Lower the basket to the frying position.
 - You can observe the cooking process by raising the lid or looking through the viewing window to observe progress.
- 6 When the food is cooked, raise the lid, lift the basket out of the oil, give it a shake, and place it in its raised rest position for a few seconds to drain.
- 7 Lift the basket out and shake the fried food into a dish with oil absorbing kitchen paper.
- 8 After use, disconnect from the mains supply and allow to cool. Wipe any spilt oil from the fryer body.
 - You can store the basket in the oil.

Cooking home-battered foods

This method allows for the fact that if wet batter is placed in the basket prior to cooking the food may stick.

- 1 Leave the basket in the down position.
- 2 Coat the raw food in the batter and allow it to drain slightly to get rid of the excess coating.
- 3 Very carefully, slowly lower the coated food into the hot oil, using a suitable implement or tongs. This allows the batter to become solid and prevents it sealing to the mesh of the basket.

WARNING: Take care as the oil may spit as the food is added.

Getting the best from your fryer

Oil

- Always ensure that you use good quality oil for deep frying. We recommend liquid vegetable oils, alternatively use corn, groundnut or rapeseed oil. Avoid mixing oils of different types and quality.
- Solid fat (lard) and solid oil can be used, this should be first melted in a pan until softened, then carefully transferred into the fryer bowl.
- Change the oil when it becomes brown or cloudy in colour, usually after frying 15 times.
IMPORTANT: Do not switch the fryer on until the fryer bowl is filled with oil or solid oil or lard.

Cooking

- Your food must always be completely dry in order to avoid overflowing, to prolong the use of the oil and to give a crispier finish to the food.
- Pieces of food should be of the same size and thickness.
- As a general guide pre-cooked foods need a higher cooking temperature than raw foods.
- Do not overload the basket as it may cause a drop of temperature that may leave the food greasy.
- Cook your food thoroughly. Remember that your food may begin to turn golden brown before it is cooked through.
- Avoid leaving food to drain for too long in the basket as the food may become soft and lose its crunchiness.
- Select your cooking utensils with care. Do not use utensils that may melt. Metal utensils become hot and therefore should have insulated handles. When using metal utensils, take care not to damage the non-stick coating of the bowl.
- All foodstuffs contain moisture. When lowered into the hot oil the water turns to steam. Most of the steam escapes harmlessly through the lid vent, but trapped steam may escape when opening the lid - so care is needed.

Chips

- Old potatoes are ideal for making chips. Your chips should be evenly sized so that they cook evenly. They should be rinsed in a colander under a cold tap and dried using a kitchen towel or absorbent paper. For best results fry your chips for 10-12 minutes; shaking the basket at intervals to ensure chips get an overall browning.
- For best results, we recommend no more than 900g of frozen chips or 1.2kg of fresh chips are fried.

Emptying and cleaning

WARNING: Cleaning should only be carried out with the plug removed from the socket. The fryer should have completely cooled. Allow 3 hours for cooling.

- 1 Remove the lid.
- 2 Remove the basket.
- 3 Lift out the bowl.

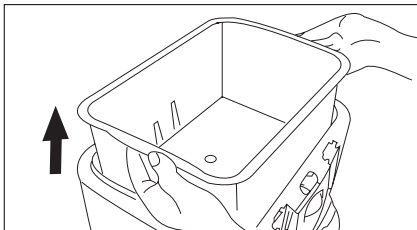

- 4 Pour out the oil through fine muslin or absorbent paper placed in a suitable funnel into a container.
- 5 Wash the lid, basket, handle and the inside of the tank by hand with hot soapy water.
 - The lid can be washed in a dishwasher.
 - The basket and bowl should **NOT** be washed in a dishwasher.
- 6 Clean the body of the fryer with a warm moistened cloth, washing up liquid can be used.

WARNING: Never immerse the control pod in water, if required remove any stains with a moistened cloth.

- 7 Dry all parts of your fryer thoroughly and reassemble all parts with the max and min at the back of the bowl. Refer to the assembly sequence.
 - The outside of the bowl is not non-stick coated, if care is taken, it is unlikely to become dirty. If oil does drip down the exterior when the oil is being emptied out, make sure that it is hand washed thoroughly. The exterior may appear discoloured, this is quite normal and will not detract from the performance of the fryer.

Helpline

If you have any difficulty with your appliance, do not hesitate to call us.

We are more likely able to help than the store from where you bought it.

Please have the following information ready to enable our staff to deal with your query quickly.

- Name of the product
- Model number as shown on the underside of the appliance.



Frying times and temperature chart

These frying times are intended as a guide only and should be adjusted to suit quantity or thickness of food and your own taste. Times listed are normally the maximum time required.

Quantities listed are for use in the large basket. When using the 2 small baskets fill as required, but make sure the food is covered with the hot bubbling oil.

Fresh cut chips	1.2kg	
190°C		10-12 mins
Frozen chips	900g	
190°C		12-15 mins
Fresh cod or haddock		
300g/400g 2 or 3 pieces		
190°C		8-10 mins
Frozen cod or haddock		
300g/400g 2 or 3 pieces		
170°C		10-15 mins
Frozen plaice		
1x150g piece		
190°C		5-6 mins
Whitebait	just enough to cover base of basket	
190°C		1-2 mins
Scampi	frozen in crumbs	
170°C		3-5 mins
	Just enough to cover base of basket.	
Beefburgers*		
150° or 170°C		
2oz/55g 4 pieces		4-6 mins
4oz/110g 2 pieces		5-10 mins
Fresh or defrosted chicken portions in crumbs*		
2 x 200g pieces		
170°C		20-25 mins
Frozen chicken portions in crumbs*		
2 x 200g pieces		
170°C		25-30 mins
Mushrooms		
200g		
190°C		2-3 mins

Weights stated are maximum advised.

*Chicken and beef burgers taint the oil leaving a taste you may not want when frying other foods, if so change the oil.

Your two year guarantee

It is important to retain the retailers receipt as proof of purchase. Staple your receipt to this back cover for future reference.

Please quote the following information if the product develops a fault. These numbers can be found on the base of the product.

Model no. Serial no.

All Morphy Richards products are individually tested before leaving the factory. In the unlikely event of any appliance proving to be faulty within 28 days of purchase it should be returned to the place of purchase for it to be replaced.

If the fault develops after 28 days and within 24 months of original purchase, you should contact the Helpline number quoting Model number and Serial number on the product, or write to Morphy Richards at the address shown.

You will be asked to return the product (in secure, adequate packaging) to the address below along with a copy of proof of purchase.

Subject to the exclusions set out below (see Exclusions) the faulty appliance will then be repaired or replaced and dispatched usually within 7 working days of receipt.

If for any reason this item is replaced during the 2 year guarantee period, the guarantee on the new item will be calculated from original purchase date. Therefore it is vital to retain your original till receipt or invoice to indicate the date of initial purchase.

Morphy Richards products are intended for household use only.

Morphy Richards has a policy of continuous improvement in product quality and design. The company, therefore reserves the right to change the specification of its models at any time.

To qualify for the 2 year guarantee the appliance must have been used according to the manufacturers instructions. For example fryers should have been regularly cleaned.

EXCLUSIONS

Morphy Richards shall not be liable to replace or repair the goods under the terms of the guarantee where:

- 1** The fault has been caused or is attributable to accidental use, misuse, negligent use or used contrary to the manufacturers recommendations or where the fault has been caused by power surges or damage caused in transit.
- 2** The appliance has been used on a voltage supply other than that stamped on the products.
- 3** Repairs have been attempted by persons other than our service staff (or authorised dealer).
- 4** Where the appliance has been used for hire purposes or non domestic use.
- 5** Morphy Richards are not liable to carry out any type of servicing work, under the guarantee.
- 6** Plastic filters for all Morphy Richards kettles and coffee makers are not covered by the guarantee.

This guarantee does not confer any rights other than those expressly set out above and does not cover any claims for consequential loss or damage. This guarantee is offered as an additional benefit and does not affect your statutory rights as a consumer.

- This guarantee is valid in the UK and Ireland only.

morphy richards[®]

The After Sales Division
Registered address
Morphy Richards Ltd, Mexborough
South Yorkshire, England, S64 8AJ

Helpline (office hours)
UK **0870 060 2613**
Republic of Ireland **1800 409119**