

The Fireplace by PurATron SAFETY INFORMATION AND INSTALLATION MANUAL

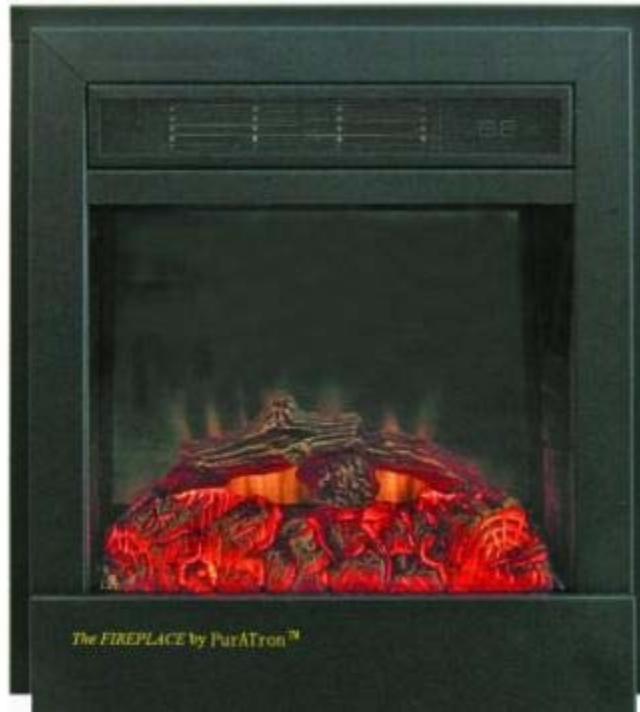

Read these instructions completely before beginning installation. Failure to follow them could cause a heater malfunction and result in serious injury and/or property damage.

WARNING: All electric heaters have hot and arcing or sparking parts inside. Do not use it in areas where gasoline, paint or flammable liquids are stored.

WARNING: This heater is tested and listed for use only with the optional accessories listed in these instructions. Use of optional accessories not specifically tested for this heater could void the heater warranty and/or result in a safety hazard.

Keep this manual for future reference.

TABLE OF CONTENTS

Safety Information	2
Listing Approvals	3
Product Dimension	3
Fireplace Placement.....	3
Specifications.....	4
Cleaning and Maintenance	6
Trouble shooting	8

SAFETY INFORMATION

Due to high temperatures, the fireplace should be located out of traffic and away from furniture and draperies.

Do not place clothing or other flammable material on or near the fireplace. Never place any objects on the fireplace.

The fireplace can become very hot when running. Keep children and adults away from hot surfaces to avoid burns or clothing ignition. The fireplace will remain hot for a time after shutdown. Allow surfaces to cool before touching.

When using electrical heaters, basic precautions, like the ones listed below, should always be followed in order to reduce the risk of fire, electric shock and injury.

- 1. Read all instructions before using this heater.**
2. Keep combustible materials, such as furniture, pillows, bedding, papers, clothes and curtains at least 3 feet from the front of the heater; keep them away from sides and rear as well.
3. Always unplug heater when it's not in use.
4. Do not operate the fireplace if it has a damaged cord or plug, after it has malfunctioned, or if the unit has been dropped or damaged in any way.
5. Do not use the heater outdoors.

Unpacking and Testing Fireplace	4
Installation	4
Operating Instructions	5

6. This heater is not intended for use in bathrooms, laundry areas and similar indoor locations. Never place the heater where it may fall into a bathtub or other water containers.

7. Do not run the cord under carpeting. Do not cover the cord with throw rugs, runners or anything else. Arrange the cord away from traffic areas where it could not be tripped over.

8. To disconnect the heater, turn the controls to "OFF" before removing the plug from the outlet.

9. Do not insert or allow foreign objects to enter any ventilation or exhaust opening, as this may cause an electric shock, fire or damage to the heater.

10. To prevent a possible fire, do not block air intakes in any manner.

11. A heater has hot and arcing or sparking parts inside. Do not use it in areas where gasoline, paint or flammable liquids are used or stored.

12. Use this heater only as described in this manual. Any other use not recommended by the manufacturer may cause fire, electric shock or injury to persons.

13. Avoid the use of an extension cord because the extension cord may overheat and cause a fire. If you have to use an extension cord, the cord should be No. 14 AWG minimum size and rated not less than 1875 WATTS.

14. Always use properly grounded fused and polarized outlets.

15. Always use ground fault protection where it is required by electrical codes.

16. Always disconnect the power before performing any cleaning, maintenance or relocation of the heater.

17. To prevent a possible fire, do not burn wood or other materials in this heater.

18 To prevent electric shock or fire, always use a certified electrician, should new circuits or outlets be required.

19. When transporting or storing the heater, keep it in a dry place, free from excessive vibration.

LISTING APPROVALS

This heater has been tested in accordance with the CSA Standards for fixed and location-dedicated electric room heaters in the United States. All components are UL or CSA safety certified.

Description:	21" Fireplace/Insert
Voltage/Hz:	120/60
Watts:	1500
Amps:	15 Amp Grounded Circuit

Note: This heater must be electrically wired and grounded in accordance with local codes or, in the absence of local codes, with National Electric Code.

PRODUCT DIMENSION

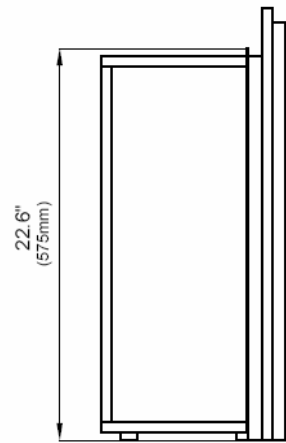
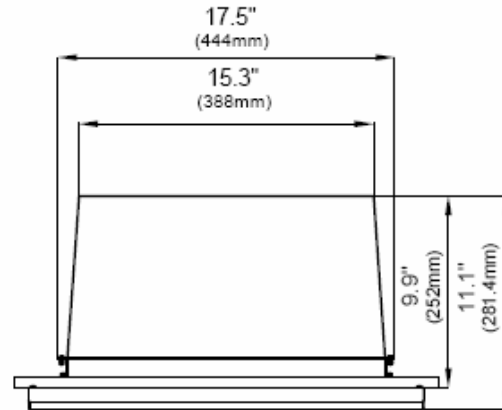
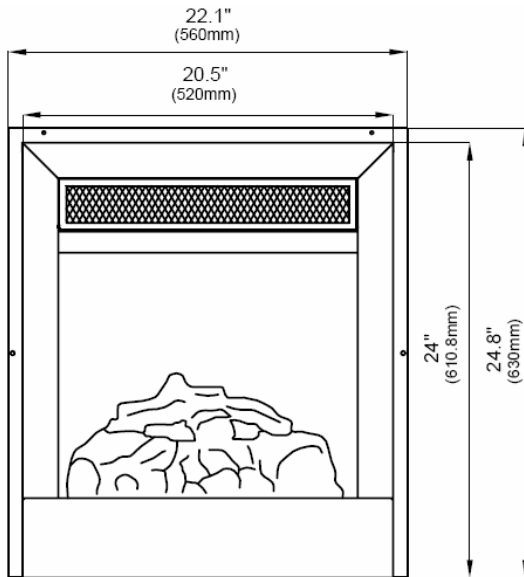

Figure 1 - Heater Dimensions

FIREPLACE PLACEMENT

⚠ WARNING: Never locate this heater where it may fall into a bathtub or any water container.

NOTICE: Minimum and maximum clearances must be maintained at all times. Illustrations throughout these instructions reflect typical installations and are for design purposes only. Actual installations may vary slightly due to individual preferences.

Figure 2 illustrates a variety of ways the heater may be located in a room. The heater may be installed directly on the floor, carpet or raised on a hearth.

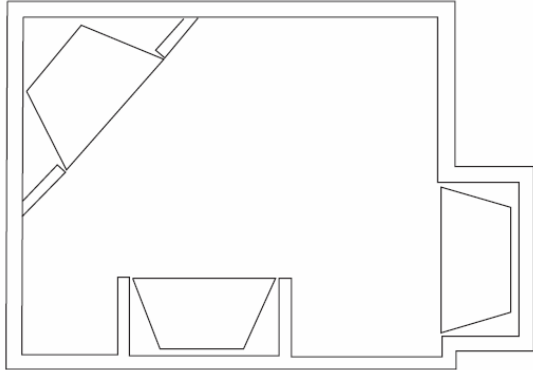

Figure 2 - Heater Locations

SPECIFICATIONS

Power Supply: 120V; 15-Amp Grounded Plug
 Frequency: 60 Hz
 BTU Output: 5,000 BTU
 Heater Power: 1,500 W
 Net Weight: 38 lbs

UNPACKING AND TESTING FIREPLACE

Carefully remove the unit from the box. Prior to permanently installing the unit, test it to make sure it operates properly. To do this, plug the unit's power supply cord into a 120-volt grounded outlet.

⚠ CAUTION: The unit's power supply cord must be connected to a properly grounded and protected 120-volt outlet. Always use ground fault protection where required by the electrical code.

INSTALLATION

⚠ WARNING - RISK OF FIRE! To prevent a possible fire, do not block the air intake or exhaust in any manner.

⚠ WARNING - RISK OF FIRE! The power cord must not be pinched or placed against a sharp edge. Secure the cord to avoid tripping or snagging thus reducing the risk of fire, electric shock or personal injury. Do not run the cord under carpeting. Do not cover the cord with throw rugs, runners or similar items. Arrange the cord away from traffic areas where it could be tripped over.

Once the mantel has been prepared, the fireplace can be installed.

Select a suitable location that is not susceptible to moisture and is away from drapes, furniture and high traffic areas. Note: Follow all national and local electrical codes. This insert can be installed into an existing mantle or as a new construction.

1. Unplug the unit and turn the power switch to the "OFF" position.
2. Push the fireplace (from the back) to the front of the mantel.
3. Secure the insert to the mantel by screwing the 4 screws supplied along with insert (See figure 3).

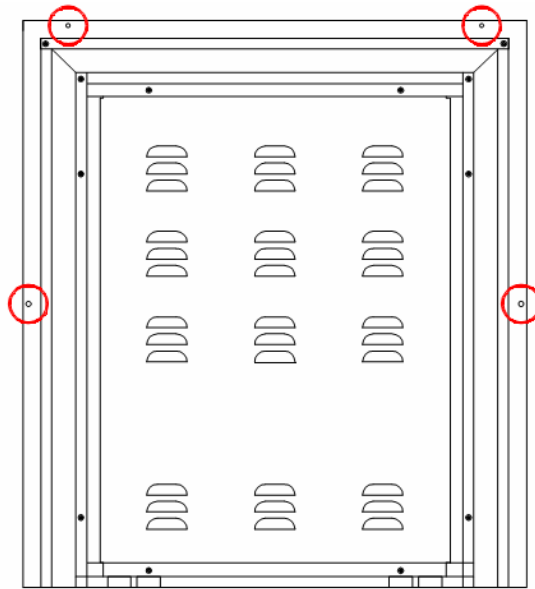

4. Plug the fireplace into a 15amp/120V, grounded outlet.

OPERATING INSTRUCTIONS

OPERATING BY CONTROL PANEL

Controls (see figure4) are located at the top behind the net.

1. Plug in your electric fireplace.
2. Push the main "ON/OFF" power switch to "I" to turn on the power. The "I" indicates ON and "O" indicates OFF.
3. Turn the "Remote/Manual" switch to the "Manual" position to operate the unit manually, using the switches and dials on the control panel.

4 Turn the "Flame and Ember" dial clockwise to increase the height of flame and brightness of the ember bed. Turn the dial counterclockwise to decrease the height of the flame and brightness of the ember bed.

5. Turn the "Heater" dial clockwise, toward number 8, to increase to the desired temperature. Turn the dial counterclockwise, toward number 1, to decrease the desired temperature.

Note: When the heater is turned on for the first time, it may release a slight, harmless odor. This odor is a normal occurrence caused by the initial heating of the internal heating elements and should not occur after the initial burn off. (This odor may occur again if dust or debris has been trapped in the unit.)

NOTICE: Number 1 to 8 means the following temperature: 50° F (10° C), 55.4° F (13° C), 60.8° F (16° C), 66.2° F (19° C), 71.6° F (22° C), 77° F (25° C), 82.4° F (28° C), 86° F (30° C).

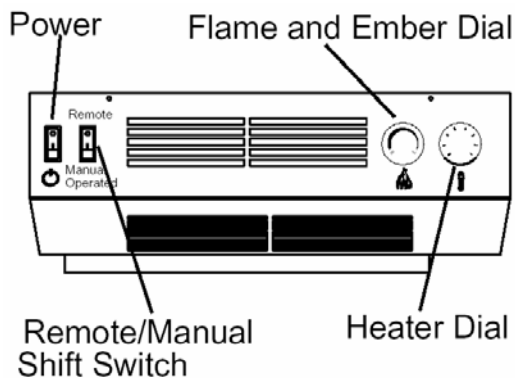

Figure 4 - Controls For Electric Fireplace

OPERATING BY REMOTE CONTROL

1. Plug in your electric fireplace.
2. Push the ON/OFF Power Button to turn the unit on. The power LED will light.
3. Turn the Remote/Manual shift switch to the Remote position to operate the insert using the remote control.
4. When operating the remote control, it must be pointed at the glass.
5. Press the ON/OFF button at the top left of the remote control to activate the power to the unit.
6. To adjust the ember bed brightness, press the

"+" button to increase the ember brightness. Press the "-" button to decrease the ember bed brightness.

7. The heater button activates the heater. Select HI, MED or LO to reach your desired temperature. HI will shut off when the room reaches approximately 86° F (30° C).

MED will shut off when the room reaches approximately 75° F (24° C).

LO will shut off when the room reaches approximately 64° F (18° C).

NOTICE: The heater will automatically turn on when room temperature drops below your desired setting.

8. To adjust the back flames, use the "FLAME" button. To increase or decrease flame, press the "+" or "-" buttons.

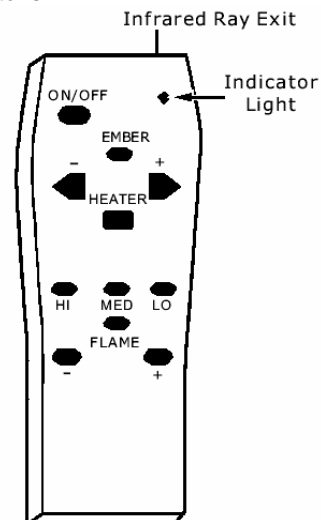

Figure 5 - Remote Control For Electric Fireplace

9. To turn off the fireplace, press the ON/OFF button once. When you restart the fireplace with the remote control, all of the features that were set will

remain in effect.

NOTICE: This remote control must remain within 26 ft. (8 m) of the fireplace to be effective.

NOTICE: Do not mix old and new batteries.

NOTICE: If you want to use the insert by the control panel, the remote/manual shift switch must be turned to the Manual operated position.

If you want to use the fireplace by the remote, the remote/manual shift switch must be turned to the Remote position.

Note: Make sure your batteries are fully charged and installed correctly in your remote control.

CLEANING AND MAINTENANCE

WARNING: Always disconnect the power and allow the heater to cool before performing any cleaning, maintenance or relocation. Turn the controls to OFF and remove the plug from the outlet or turn off the circuit breaker before attempting any cleaning.

BACK GLASS

1. The glass is cleaned in the factory during assembly. During shipment, installation, handling, etc. the glass surface may collect dust particles. These can be removed by buffing lightly with a clean dry cloth.

2. To remove fingerprints or other marks, the glass can be cleaned with a damp cloth using a good quality household glass cleaner. The glass should be completely dried with a lint free cloth or paper towel.

3. In the event of glass breakage, vacuum all remaining glass pieces with a shop vac. DO NOT VACUUM WHILE THE PIECES ARE HOT. Replace glass only with replacement parts made specifically for this heater. Never substitute material. Only fully tempered soda lime safety glass may be used on this heater.

BULB REPLACEMENT

WARNING: The halogen light bulbs in your unit can become extremely hot. Allow at least 10 minutes between turning off the heater and removing the light bulbs to avoid accidental burns.

There are a total of 6 halogen light bulbs (type GX6.35 in your unit.

- 2 bulbs provide illumination for the ember bed beneath the log set(120V,35w Max.)
- 2 bulbs provide illumination for the flame generation assembly (120V, 45w Max.)
- 2 bulbs are for replacement

WARNING: Do not install replacement bulbs that exceed specified maximum watts.

Your fireplace must be opened in order to replace the light bulbs. To reduce the number of times you need to open the unit, replace all bulbs at the same time. If the unit has been running, turn off the power and let fireplace cool before changing bulb.

EMBER BED BULBS

1. Disconnect the power.
2. Remove the back cover by removing 6 screws in the back.(See Figure6)

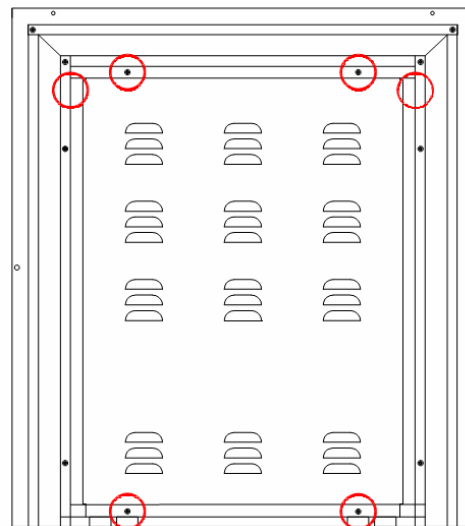

Figure 6

3. Reach inside and remove the spring clip. Pull out the old bulbs. (See Figure7)

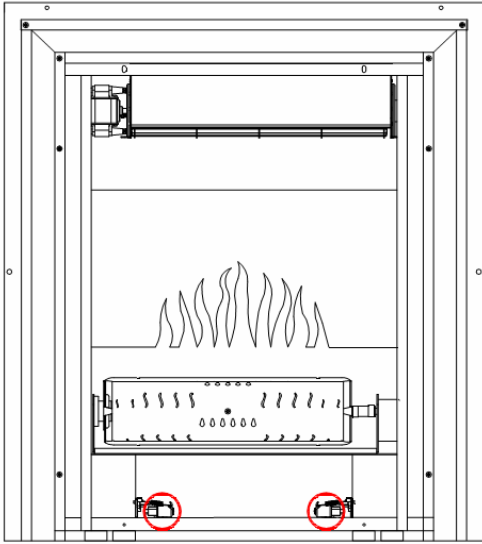

Figure 7

4. Hold the socket and push in the new bulb (DO NOT exceed wattage).
5. Repeat steps 3 and 4 with the second bulb. Reconnect the spring.
6. Replace the back cover.

FLAME GENERATION BULBS

1. Disconnect the power.
2. Remove the back cover by removing 6 screws in the back.(see Figure6)
3. Locate the flame generation cylindrical drum.
4. Remove the 2 screws on the cylinder drum. (See Figure8)

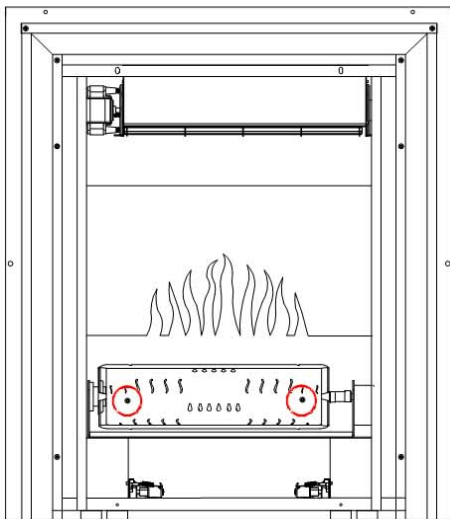

Figure 8

5. Squeeze half of drum cylinder until its top edge clears the top drum track. Remove the bottom edge of cylinder drum from the bottom drum track. This will give you access to the light bulbs.

Note: Do not exert excessive pressure on the drum cylinder, as this may cause damage.

6. Remove the spring clip. Hold socket and pull out the old bulb.(See Figure9).

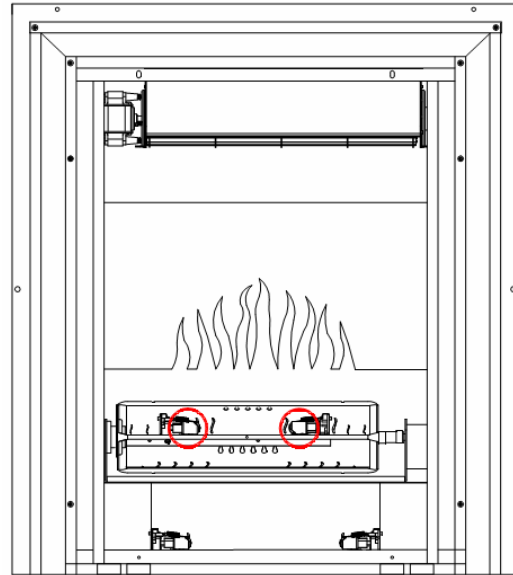

Figure 9

7. Hold the socket and push in the new bulb (DO NOT exceed wattage).
8. Repeat steps 6 and 7 for the second bulb. Reconnect the spring.
9. Replace the back cover.

TROUBLE SHOOTING

⚠ WARNING: Turn off the appliance and let it cool before servicing it. Only a qualified service person should service and repair the heater.

OBSERVED PROBLEM	POSSIBLE CAUSE	REMEDY
Fireplace turns off and will not turn on	1. Fireplace has overheated and safety device has caused thermal switch to disconnect or home circuit breaker has opened	1. Reset switch by turning main power switch off and waiting 5 minutes, then turning it back on
Flame is not moving	1. Bulbs are burnt out 2. Wiring is loose	1. Inspect bulbs and replace if necessary. 2. Inspect wiring for loose connections and repair or replace if necessary
Log set and/or ember is not glowing	1. Bulbs are burnt out	1. Inspect bulbs and replace if necessary
Flame sputters	1. Flame motor is defective	1. Call a qualified service technician
Remote control does not work	1. Low Batteries 2. Remote/Manual shift switch is in Manual position 3. Power switch is in OFF Position	1. Replace AA batteries in remote control 2. Turn Remote/Manual shift switch to Remote position. 3. Turn on the main power switch
Heater does not provide heat when turned on	1. Thermal switch has been tripped 2. Circuit breaker has been tripped	1. Turn the unit off and unplug the unit for 5 minutes. Plug back in and turn the unit on. If plug can not be reached, follow directions for tripped circuit breaker 2. Turn off circuit breaker that supplies electricity to the unit. Wait 5 minutes then flip circuit Breaker back on.



Very Important!

PLEASE KEEP THIS INFORMATION WITH YOUR INSTRUCTION MANUAL

- In the unlikely event that your unit does not appear to be working properly, you may contact your Sales Representative for immediate assistance.
- Prior to your call, we encourage you to visit our service-related website www.edenpureservice.com for numerous troubleshooting tips and possible service instructions if needed.
- If you are unable to reach your Sales Representative and www.edenpureservice.com does not answer your questions, you may contact our Resource Partner's Customer Service Team by calling 1-866-786-8946 or email us at custserv@rppurchase.com.
Please have your proof of purchase handy when you make your call or Resource Partners will be unable to assist you. The information necessary for us to help you will be on your proof of purchase.

Thank you!