

# **MIB MASTER-BILT**® *Refrigeration Solutions*



## **GT-50, GT-60 & GT-80** **Installation & Operations Manual**

**J - Version**

**Master-Bilt Products**  
908 Highway 15 North  
New Albany, MS 38652  
Phone: (800) 684-8988

PN 029-91000  
Rev \_ 2-21-07



## TABLE OF CONTENTS

<b>INTRODUCTION</b> .....	<b>4</b>
<b>STORE CONDITIONS</b> .....	<b>4</b>
<b>WARNING LABELS AND SAFETY INSTRUCTIONS</b> .....	<b>5</b>
<b>PRE-INSTALLATION INSTRUCTIONS</b> .....	<b>5</b>
Inspection for Shipping Damage .....	5
<b>INSTALLATION INSTRUCTIONS</b> .....	<b>6</b>
General Instructions .....	6
Electrical .....	6
Mechanical .....	6
Leveling Cabinet.....	6
Grille Removal and Compressor Check.....	7
Startup.....	7
Fan Operation and Vibration; Voltage Check.....	7
Thermostat Check.....	7
Defrost and Temperature Control .....	7
<b>REFRIGERATION SYSTEM AND OPERATION</b> .....	<b>8</b>
<b>CLEANING</b> .....	<b>9</b>
<b>EXTERIOR PARTS NOMENCLATURE</b> .....	<b>9</b>
Glass Lid and Top Deck Removal.....	9
Drain Pan, Light Shield, and Lamp Removal/Replacement .....	10
<b>SERVICE INSTRUCTIONS</b> .....	<b>10</b>
Operation Conditions and Pressures .....	10
Trouble Shooting Guide .....	11
<b>MASTER-BILT PART NUMBERS</b> .....	<b>12</b>
<b>ACCESSORIES</b> .....	<b>13</b>
<b>SALE AND DISPOSAL</b> .....	<b>13</b>
<b>WIRING DIAGRAMS GT</b> .....	<b>14-15</b>

## INTRODUCTION

Thank you for purchasing a Master-Bilt cabinet. This manual contains important instructions for installing, using and servicing a Master-Bilt **GT** case. A parts list is included in with this manual. Read all these documents carefully before installing or servicing your equipment.

## STORE CONDITIONS

The Master-Bilt **GT** cases are designed to operate in the controlled environment of an air-conditioned store. The store temperature should be at or below 75°F and a relative humidity of 55% or less. At higher temperature or humidity conditions, the performance of these cases may be affected and the capacity diminished. It is not uncommon in a newly constructed store for the temperature and humidity to be above design conditions. These excessive conditions may produce sweating in the case until the store is operational and the ambient environment is more desirable.

The Master-Bilt **GT** should not be positioned where it is directly exposed to rays of sun or near a direct source of radiant heat or airflow. This will adversely affect the case and will result in poor performance.

The Master-Bilt **GT** cabinets may be placed directly against the wall. This is due to the cabinet's condenser cooling air entering and discharging through the front grille.



**Read this manual before installing your cabinet. Keep the manual and refer to it before doing any service on the equipment. Failure to do so could result in personal injury or damage to the cabinet.**



**Improper or faulty hook-up of electrical components of the refrigeration units can result in severe injury or death.**

**All electrical wiring hook-ups must be done in accordance with all applicable local, regional or national standards.**



**Installation and service of the refrigeration and electrical components of the cabinet must be performed by a refrigeration mechanic and/or a licensed electrician.**

The portions of this manual covering refrigeration and electrical components contain technical instructions intended only for persons qualified to perform refrigeration and electrical work. This manual cannot cover every installation, use or service situation. If you need additional information have the serial number at hand and call or write us:

Customer Service Department  
Master-Bilt Products  
Highway 15 North  
New Albany, MS 38652  
Phone (800) 684-8988  
Fax (800) 684-8988

## WARNING LABELS AND SAFETY INSTRUCTIONS



This symbol is the safety-alert symbol. When you see this symbol on your cabinet or in this manual, be alert to the potential for personal injury or damage to your equipment.

Be sure you understand all safety messages and always follow recommended precautions and safe operating practices.



### NOTICE TO EMPLOYERS

**You must make sure that everyone who installs, uses or services your cabinet is thoroughly familiar with all safety information and procedures.**

Important safety information is presented in this section and throughout this section and throughout the manual. The following signal words are used in the warnings and safety messages:

**DANGER:** Severe injury or death will occur if you ignore the message.

**WARNING:** Severe injury or death can occur if you ignore the message.

**CAUTION:** Minor injury or damage to your cabinet can occur if you ignore the message.

**NOTICE:** This is important installation, operation or service information. If you ignore the message, you may damage your cabinet.

**The warning and safety labels shown throughout this manual are placed on your Master-Bilt Products cabinet at the factory. Follow all warning label instructions. If any warning or safety labels become lost or damaged, call your customer service department at (800) 684-8988 for replacements.**

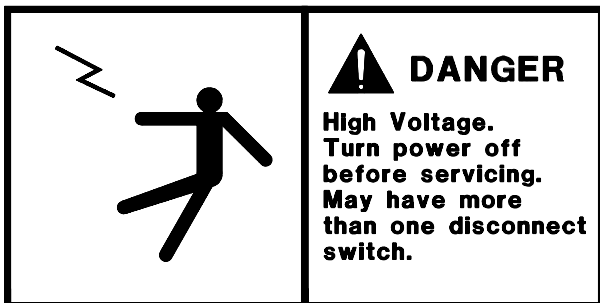

*This label is located on top of the electrical control label and on the wiring channel.*

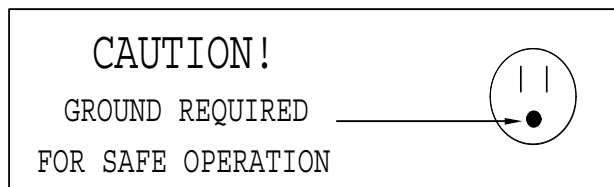

*This label is attached to the cabinet power cord on models with a power cord.*

## PRE-INSTALLATION INSTRUCTIONS

### INSPECTION FOR SHIPPING DAMAGE

You are responsible for filing all freight claims with the delivering truck line. Inspect all cartons and crates for damage as soon as they arrive. If damage is noted to shipping crates or cartons or if a shortage is found, note this on the bill of lading (all copies) prior to signing.

If damage is discovered when the cabinet is uncrated, immediately call the delivering truck line and follow up the call with a written report indicating concealed damage to your shipment. Ask for an immediate inspection of your concealed damage item. Crating material must be retained to show the inspector from the truck line.

## INSTALLATION INSTRUCTIONS

### GENERAL INSTRUCTIONS

1. Be sure the equipment is properly installed by competent service people.
2. Keep the equipment clean and sanitary so it will meet your local sanitation codes.
3. Rotate your stock so that older stock does not accumulate. This is especially important for ice cream. A "First-In, First-Out" rotation practice will keep the products in good sellable condition.
4. Do not place product in the case when it is soft or partially thawed. Also, product should not be put in the case for at least 6 hours after it is started.
5. Stock cases as quickly as possible, exposing only small quantities to store temperatures for short periods of time.
6. When replacing burned out fluorescent tubes, be sure that the electrical power to the lighting circuit is turned off.

### NOTICE TO STORE OWNERS / MANAGERS

**Moisture or liquid around or under the cabinet is a potential slip/fall hazard for persons walking by or working in the general area of the cabinet. Any cabinet malfunction or housekeeping problem that creates a slip/fall hazard around or under the cabinet should be corrected immediately.**

If moisture or liquid is observed around or under a Master-Bilt cabinet, an immediate investigation should be made by qualified personnel to determine the source of the moisture or liquid. The investigation should determine if the cabinet is malfunctioning or if there is a drainpipe leaking.

### ELECTRICAL



**Before servicing electrical components in the case, make sure all power to case is off. Always use a qualified technician.**

### ELECTRICAL INFORMATION AND GROUNDING

**A separate circuit for each cabinet is recommended to avoid the possibility of other appliances on a circuit to one of these cabinets overloading that circuit and causing malfunction. The electrical service should be grounded upon installation.**

### MECHANICAL

#### LEVELING CABINET

Level the cabinet so as to insure proper drainage of the drain pan and proper operation of the lids and refrigeration system. The GT cabinet condenser has cooling air entering and discharging through the front grille. This allows the cabinet to be placed against a wall or solid object without blocking the flow of condenser air.

To comply with Sanitation requirements, the cabinet must be mounted on legs (6" high minimum) or the base must be sealed to the floor using N.S.F. listed RTV silicone sealant. Minimum clearance as follows: 0" rear and side, top and front are open required for compliance.

## GRILLE REMOVAL AND COMPRESSOR CHECK

**Remove grille and check refrigeration lines to see that they are free (not touching each other or compressor). Spin condenser fan blade to see that it is free.**

Check that all service valves (2) are open (if equipped). The compressor is hermetic, it is internally spring mounted and ready to run.



Hermetic Compressor

## STARTUP

### FAN OPERATION AND VIBRATION; VOLTAGE CHECK

Uncoil the lead cord and pass it through the hole provided in the cover. While the cabinet is in operation, check the voltage draw and the amperage draw versus this rating on the nameplate. Check for fan noise and vibration, while the fan is running. Voltage should be checked at the compressor terminals while the compressor is initially starting. The unit is designed to operate at +/- 10% of 115 volts, 60 cycle, single phase. This means that the voltage should be between 103 and 126.5 volts.

### THEROMSTAT CHECK

After the cabinet has pulled down in temperature to approximately 0°F at load line, check the thermostatic control by turning it to its warmest position. This should shut the compressor off. Also check that the main double-pole double throw toggle switch turns the refrigeration system and cabinet lights. A separate circuit for each cabinet is recommended to avoid the possibility of other appliances on a circuit overloading the circuit and causing a malfunction. Make sure that the electrical service is grounded upon installation.

## DEFROST AND TEMPERATURE CONTROL SETTINGS

The **GT** cabinet has a temperature control that is adjustable from #1 (warmest setting) to #9 (coldest setting). Turn the control knob in line with the punch mark to the desired setting. The temperature control is located near the condensing unit at the bottom of the cabinet.

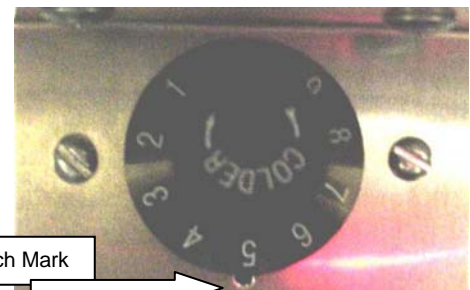

The unit defrost is controlled by a timer in the control box. After removing the condenser grille, the control box will slide out until the defrost timer is visible. The factory set defrost is two times in 24 hours with a maximum timed interval of 30 minutes. The unit contains a defrost termination sensor so in actual use the defrost time will be less than 30 minutes in most cases. The timer can be converted to operate for a timed defrost termination by disconnecting the blue/white from the X terminal. NOTE: When disconnected, it is recommended that the terminal be cut off of the blue/white wire and the wire end be capped with a wire nut.

The defrost time is set by switching a white key from the center to the outside edge of the dial. Each key is 15 minutes so two successive keys must be switched outward for a 30 minute maximum time defrost. If it is noted that more defrost time is needed, then switch outward the third successive key for a 45-minute maximum timed defrost. If another defrost in 24 hours is needed then more keys can be switched outward as needed. If possible, try to keep defrosts evenly spaced in a 24 hour period.

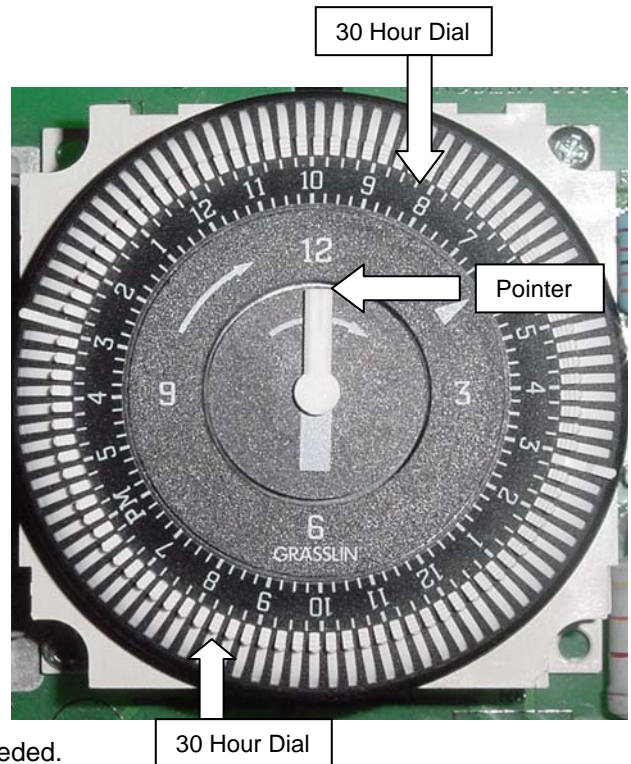

The current time can be set by turning the outer dial in the direction of the arrow until the correct clock time is shown and the small arrow aligns with either the AM or PM scale.

**NOTE:** The cabinet serial number for the GT is on the data plate located on the end opposite the condensing unit.

## REFRIGERATION SYSTEM AND OPERATION

The cabinet utilizes a Hermetic compressor and operates with refrigerant 404A. Cabinet operates on 115/60/1 power. The cabinet has a bare tube type condenser, which virtually eliminates the possibility of condenser blockage by dust and dirt.

The cabinet operates with a specific charge of refrigerant 404A. The amount of the charge of refrigerant is listed on the cabinet nameplate in ounces. These systems use one or two captubes to meter refrigerant to the evaporator. They include automatic electric defrost systems which are time initiated (by the timeclock) and terminated by a defrost termination thermostat which is mounted on a coil supporting bracket in the gravity coil section directly beneath the top of the cabinet. This defrost termination overrides the time clock and turns the compressor back on line when the gravity coil is defrosted. This is the point at which the coil has reached sufficient temperature to incur complete defrost. If the defrost termination control should fail to operate, the time clock will automatically turn off defrost and again turn on the compressor after the 34 minute (or the time interval you selected) interval set on the time clock. If the time clock fails to turn the heaters off, a final back-up safety thermostat will shut off the heaters when gravity coil temperature reaches +80 °F.

Cabinet has a refrigeration system known as automatic defrost gravity coil with cold wall construction. This means the inner liner of the cabinet below the load level line is refrigerated by gravity flow of air from a fin and tube coil, as well as copper refrigerant lines attached to the back of the inner liner tank on all sides and the bottom.



## CLEANING

**WARNING: DO NOT REMOVE FROST WITH A KNIFE, PICK, OR SHARP OBJECTS. DO NOT USE ABRASIVE CLEANERS OR CAUSTIC CLEANERS OR SCOURING PADS**

Every 30 to 60 days (depending on frost accumulation), the cabinet should be emptied, warmed up, and wiped down using a solution of 1 teaspoon of baking soda with 1 quart of water. This solution will help eliminate odors. Do not use strong soaps or detergents as they leave odors that can contaminate your product. The **GT** line cabinets are equipped with a floor drain that exits out the lower rear of the cabinet. This exit has a convenient garden hose fitting.

If it is not convenient to turn the power off the cabinet, lay a piece of plastic sheeting on the floor of the cabinet and scrape the frost off walls using a plastic scraper. Do not use metal scrapers. This will damage the interior paint of the cabinet.

## EXTERIOR PARTS NOMENCLATURE

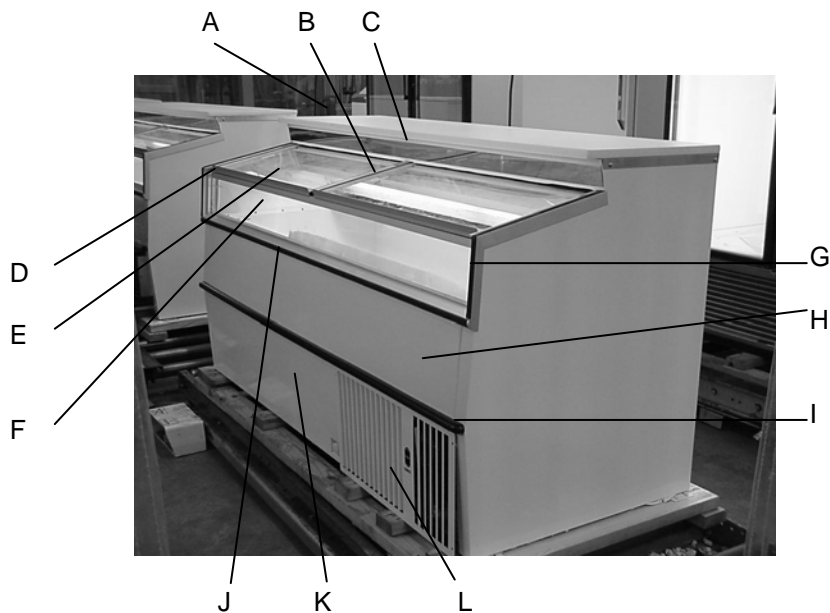

- A. TOP DECK
- B. CENTER TRACK
- C. TRIM MOLDING
- D. GLASS RAIL
- E. GLASS LID
- F. FRONT GLASS

- G. VERTICAL TRIM
- H. FRONT PANEL
- I. LOWER BUMPER
- J. UPPER BUMPER
- K. ACCESS PANEL
- L. UNIT GRILLE

## Glass Lid and Top Deck Removal

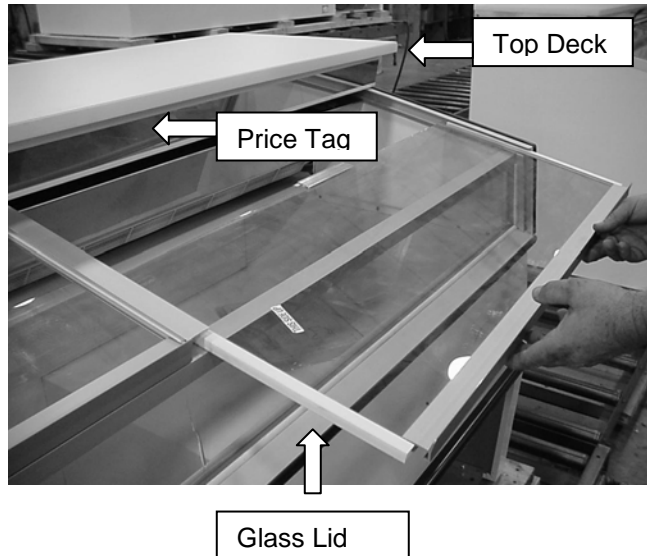

To remove the glass lid, start in the closed position and lift up on the front extrusion. Pull the glass lid towards you to remove it from the track. Reverse procedure to reinstall.

To remove the top deck, slide (remove) insert strip from price tag moulding. Remove screws which are now exposed to remove the price tag moulding. Remove screws on sides of the cabinet which also attach the top deck. Reverse procedure to reinstall.

## Drain Pan, Light Shield, and Lamp Removal /Replacement

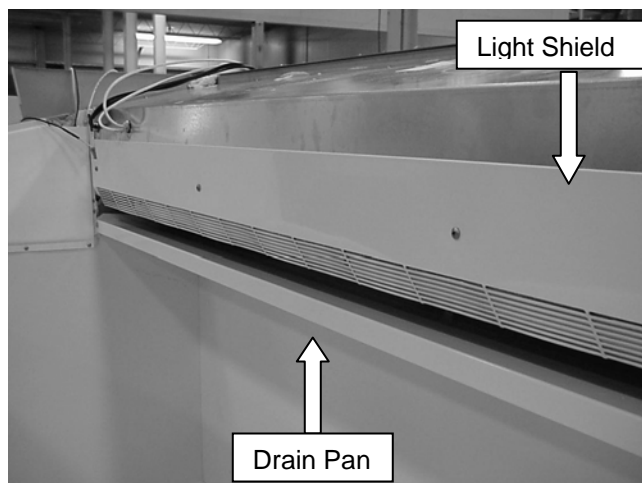

To remove the drain pan, remove screws along the front face of the drain pan. Lift the rear of the pan up and out of the drain trough. Slide pan towards you and out. Reverse procedure to install.

To remove the light shield, remove screws along the front face of the light shield. Pull the light shield towards you and out. Reverse procedure to reinstall.

The fluorescent lamps are held in place with spring type retainers. First turn off the lamps at the toggle switch or unplug the cabinet from the wall outlet. To remove the lamps push toward the spring-loaded retainer until completely compressed and rotate the lamp down and out of the fixed retainer. Installation is the reverse of removal.

## SERVICE INSTRUCTIONS

### OPERATION CONDITIONS AND PRESSURES

With room ambient temperature of +80 °F and cold cabinet (unit cycling on control):

Suction pressure – 6 to 8 psig.  
Head pressure – 240 to 260 psig.

If room ambient is low, 60 °F or lower, then the suction pressure could be as low as 4 psig. Temporary block the condenser coil to raise head pressure to 240 psig in order to verify proper charge and a suction pressure of 6psig to 8 psig. Remove blockage after pressure check.

## TROUBLE SHOOTING GUIDE

1. High head pressure and high back pressure:
  - A. Condenser coil clogged or restricted.
  - B. Condenser fan motor defective.
  - C. Air in the system.
  - D. Refrigeration overcharge.
2. Low back pressure and low head pressure:
  - A. Restriction in system.
  - B. Refrigerant undercharged.
  - C. Leak in system.
3. Pressures normal – cabinet warm:
  - A. Refrigerant undercharged.
  - B. Control set too warm.
4. Compressor starts and runs – but cycles on overload:
  - A. Low voltage.
  - B. Overload protector defective.
  - C. High head pressure (see#1).
  - D. Refrigerant under charged.
5. Compressor will not start – hums, but cycles on overload:
  - A. Low voltage.
  - B. Relay defective.
  - C. Overload defective.
  - D. High head pressure (see #1).
6. Cabinet sweating:
  - A. High ambient humidity.
  - B. Defective condensate heater.
7. Cabinet not cycling – coil blocked with frost:
  - A. Defective temperature controller.
  - B. Refrigerant overcharged.
  - C. Location too hot.
  - D. Condenser clogged.
  - E. Condenser fan motor defective.
  - F. Defrost heater not operating.
8. Gravity coil will not defrost (coil loaded with ice or frost)
  - A. Solenoid in timer sticking closed, preventing unit from going into defrost.
  - B. Defrost termination thermostat is defective.
  - C. Safety thermostat is defective.
  - D. Timer defrost is not set at minimum 30 minutes
  - E. Defective defrost coil heater.
9. Defrost cycle too long.
  - A. Defective time clock solenoid.
  - B. Defective defrost end thermostat and/or defective safety thermostat.

10. Special service situations:

If moisture or liquid is observed around or under a Master-Bilt cabinet, an immediate investigation should be made by qualified personnel to determine the source of moisture or liquid. The investigation made should determine if the cabinet is malfunctioning or if there is a simple housekeeping problem.

Moisture or liquid around or under a cabinet is a potential slip/fall hazard for persons walking by or working in the general area of the cabinet.

Any cabinet malfunction or housekeeping problem that creates a slip/fall hazard around or under a cabinet should be corrected immediately.

## MASTER-BILT PART NUMBERS

The table below gives Master-Bilt part numbers. Use this chart when ordering replacement parts for your **GT** cases.

Description	GT-50	GT-60	GT-80
Aluminum Extrusions:			
Bumper	49-01127	49-01128	49-01129
Upper Hand Rail	49-01122	49-01123	49-01124
Lid Handle	49-01118	49-01119	49-01120
Trim, L.H. and Front	49-01138	49-01138	49-01138
Trim, R.H. and Front	49-01139	49-01139	49-01139
Coil Defrost Heater	17-00488	17-00491	17-00492
Compressor	03-14902	03-14902	03-14902
Condenser Coil	07-13296	07-13296	07-13296
Condenser Fan Blade	15-13093	15-13093	15-13093
Condenser Fan Motor	13-00311	13-00311	13-00311
Condenser Fan Motor Bracket	13-00754	13-00754	13-00754
Crankcase Pressure Valve			
Defrost Heater Clip	17-09128	17-09128	17-09128
Defrost Termination Control	19-01163	19-01163	19-01163
Drain Trough Heater	17-00448	17-00449	17-00451
Drier	09-09171	09-09171	09-09171
Evaporator Coil	07-01018	07-01019	07-01017
Capillary tub	11-01450	11-01450	11-01450
Fluorescent Lamp, 24"		23-01576	
Fluorescent Lamp, 36"	23-01577	23-01577	23-01577
Front Glass Heater	17-00394	17-00392	17-09039
Front Glass Seal	31-00859	31-00859	31-00859
Glass	31-01171	31-01172	31-01174
Glass Lid	31-00853	31-00851	31-00850
Heater Safety Control	19-01164	19-01164	19-01164
Lamp Ballast	23-01693	23-01693	23-01693
Lid Center Track	49-01131	49-01131	49-01131
Light Shield Heater	17-00397	17-00386	17-00385
Mullion Heater	17-00389	17-00387	17-00388
Plastic Trim, RH Side Panel	29-00600	29-00600	29-00600
Plastic Trim, LH Side Panel	29-00601	29-00601	29-00601
Power Cord	21-00312	21-00312	21-00312
Price Tag Extrusion, 10'	49-01434	49-01434	49-01434
Side Panel Heater, RH	17-00408	17-00408	17-00408
Side Panel Heater, LH	17-00409	17-00409	17-00409
Lamp Socket, Spring	23-01698	23-01698	23-01698
Lamp Socket, Fixed	23-01699	23-01699	23-01699
Temperature Control	19-13765	19-13765	19-13765

Timer	19-00818	19-00818	19-00818
Toggle Switch	19-01090	19-01090	19-01090
Toggle Switch (Lights and Heaters)	19-00199	19-00199	19-00199

## ACCESSORIES

Description	GT-50	GT-60	GT-80
Casters 3" Dia.	A029-11140 (4)	A029-11140 (4)	A032-11140 (6)
Load Level Shelves	A030-18027	A031-18027	A033-18027
Lid Locking Kits-Less Locks	A029-11129	A029-11129	A032-11129
Novelty Baskets (White Epoxy-Coated) 9.125" X 12" X 7.125"	33-01405	33-01405	33-01405
Sack Rack 48" X 17.5" X 3"	A030-20400	A030-20400	A030-20400
Superstructures	A030-20200	A031-20200	A032-20200

## SALE AND DISPOSAL

### OWNER RESPONSIBILITY

If you sell or give away your Master-Bilt cabinet you must make sure that all safety labels and the Installation - Service Manual are included with it. If you need replacement labels or manuals, Master-Bilt will provide them free. Contact the customer service department at Master-Bilt at (800) 684-8988.

The customer service department at Master-Bilt should be contacted at the time of sale or disposal of your cabinet so records may be kept of its new location.

If you sell or give away your Master-Bilt cabinet and you evacuate the refrigerant charge before shipment, Master-Bilt recommends that the refrigerant charge be properly recovered in compliance with section 608 of the Clean Air Act effective November 1995 and in accordance with all applicable local, regional, or national standards.

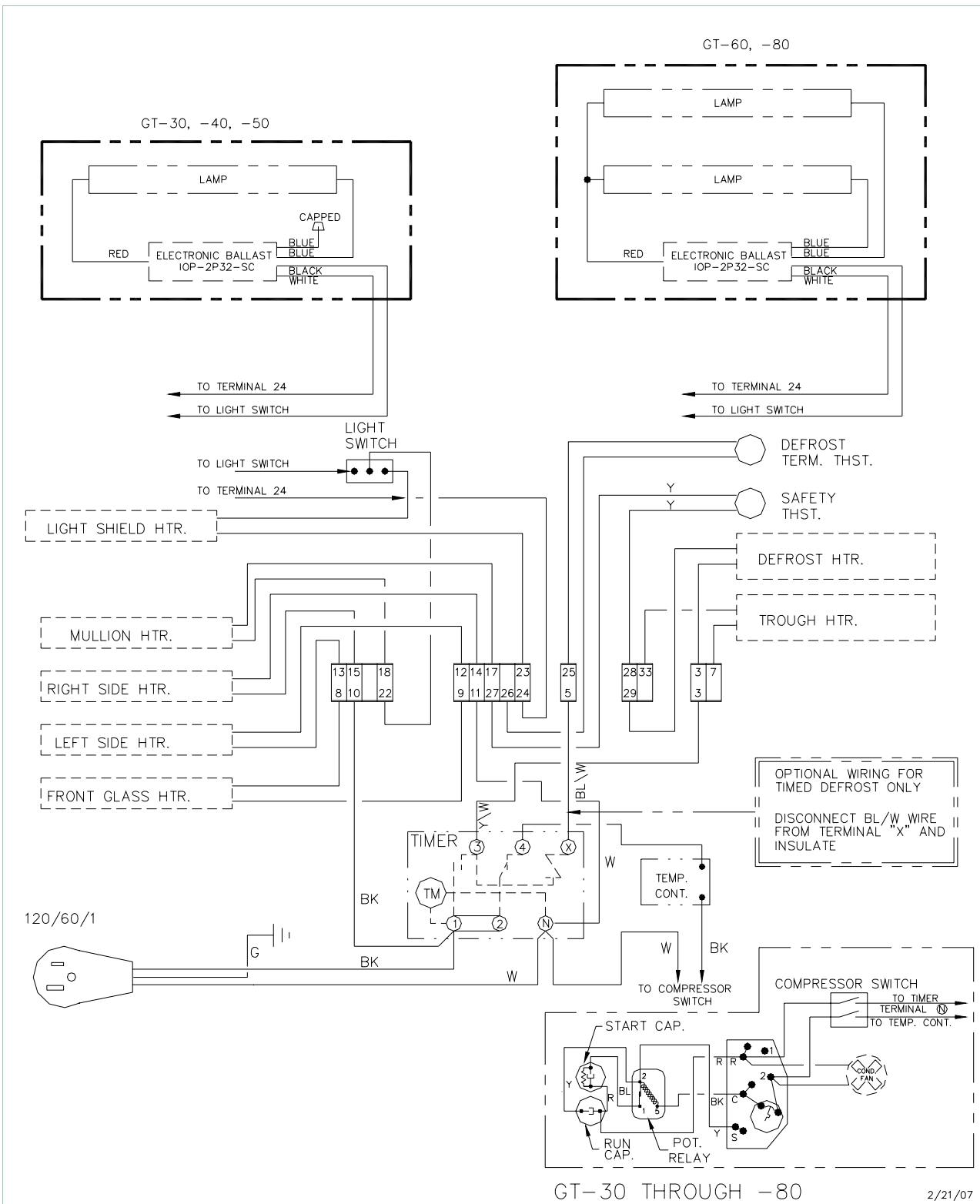

WIRING DIAGRAM GT-30, -40, -50, -60, -80  
(WITH ELECTRONIC BALLAST)

GT115EB

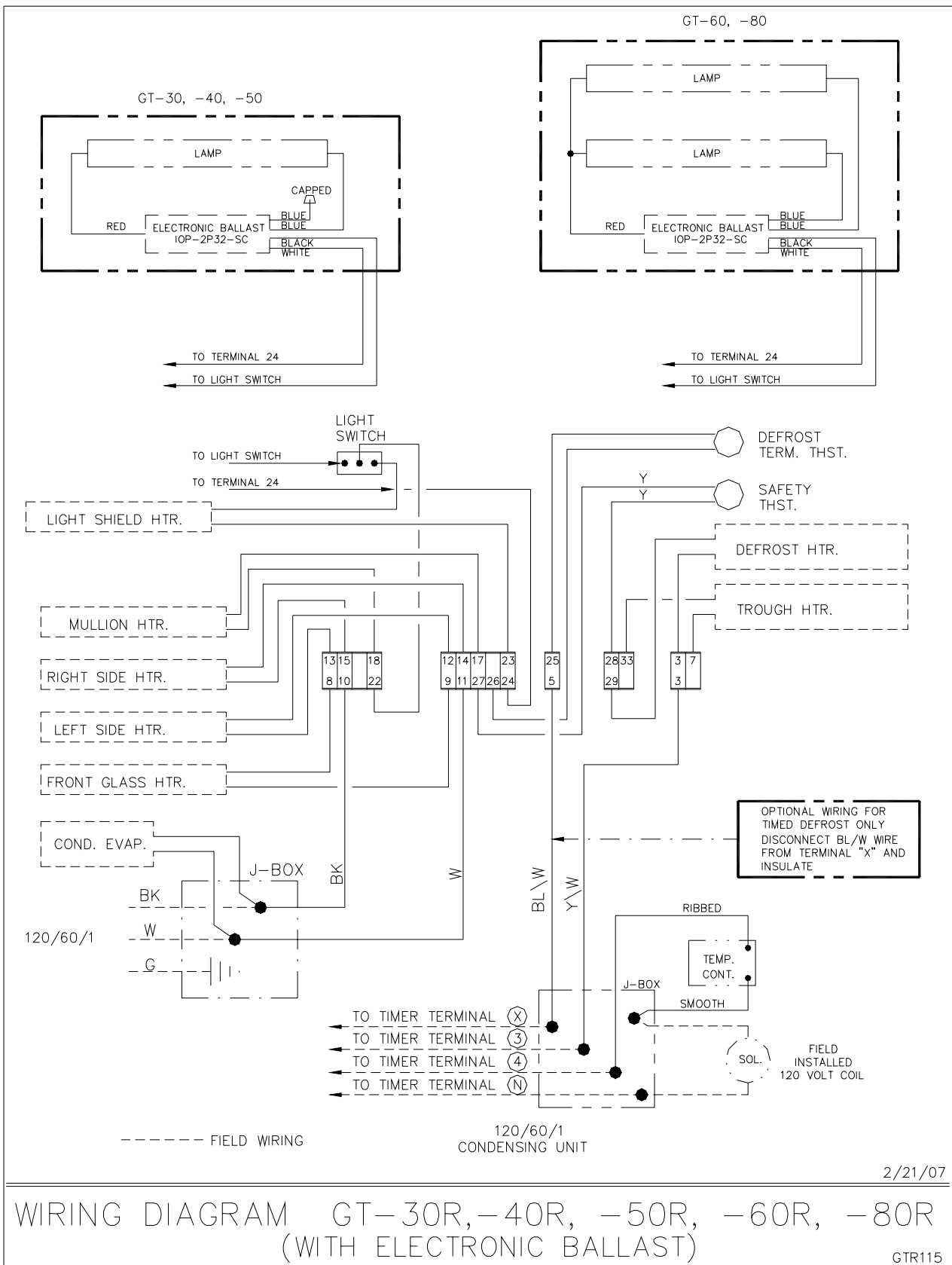

WIRING DIAGRAM GT-30R, -40R, -50R, -60R, -80R  
(WITH ELECTRONIC BALLAST)

GTR115