

TOSHIBA

Carrier

AIR-DISCHARGE DIRECTION KIT FOR AIR CONDITIONER (SPLIT TYPE)

Installation Manual

Air-Discharge Direction Kit
(for 4-way air discharge cassette Type)

Model name:

Air-discharge direction kit

TCB-BC1602UUL

Installation Manual Air-discharge direction kit	1	English
--	---	---------

Manuel du propriétaire Climatiseur (Type à deux éléments)	7	Français
--	---	----------

- Thank you for purchasing the “Air-discharge direction kit” of TOSHIBA/Carrier Air Conditioner. Before starting the installation work, please read this manual carefully and install the product properly.
- As for the “**Safety precaution**”, please read the installation manual and the instruction manual for the 4-way air discharge cassette type air conditioner (indoor unit) carefully, and also read the installation manual supplied with the ceiling panel carefully.
- Please use this kit when controlling the air direction in 3-way or 2-way air flow depending on the installation location status of the indoor unit.

1 APPLICABLE MODELS AND APPLICATIONS

MODEL	Applicable model	Application
TCB-BC1602UUL	SP180 to SP420	Controlling the blockage of 3-way or 2-way air flow.

2 ACCESSORIES

The following parts are included.

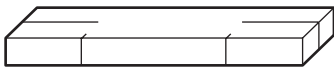
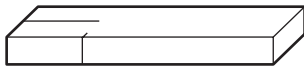
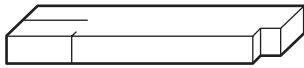
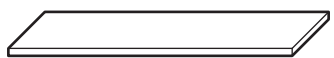
MODEL	Product name	Dimensions (in (mm))	Shape	Quantity
TCB-BC1602UUL	Wind shield	A 18.9" x 3.2" x 1.6" (480 x 80 x 40)		1
		B 15.8" x 3.2" x 1.6" (400 x 80 x 40)		1
		C 15.8" x 3.2" x 1.6" (400 x 80 x 40)		1
	Packing	18.1" x 4.3" x 0.1" (460 x 110 x 2)		2

3 INSTALLATION METHODS

CAUTION

- Before installing the wind shield, change the air conditioner settings. Refer to “Changing the setting” on page 4.
- Unless the setting is changed, the air blow temperature becomes low. This may cause the dew condensation.

■ Installing the wind shield(s) and packings

- Attach the wind shields to the air flow openings (made of styrene foam) of the indoor unit and place the packings on them to block the air flow. (Refer to Fig. 1 to 3.)
- Put the packings bending along the edges of the indoor unit external surface without blocking the concaved portions of the drain pans. (If the packings are not put bending along the edge of the indoor unit external surface, the dew condensation may occur.) (Refer to Fig. 1 and 3.)
- * The size adjustment is required for the packing which are attached on the wind shield C. Cut 1.58” (40 mm) to adjust its size in 16.5” x 4.3” (420 mm x 110 mm).

(Fig. 1)

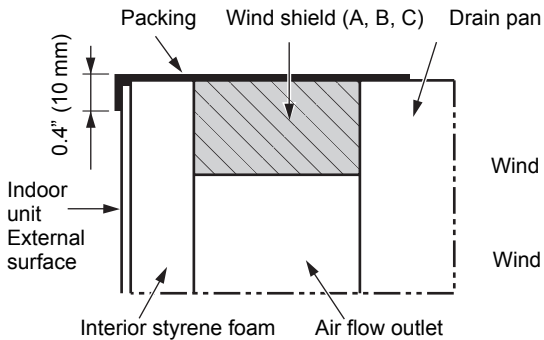

(Fig. 2)

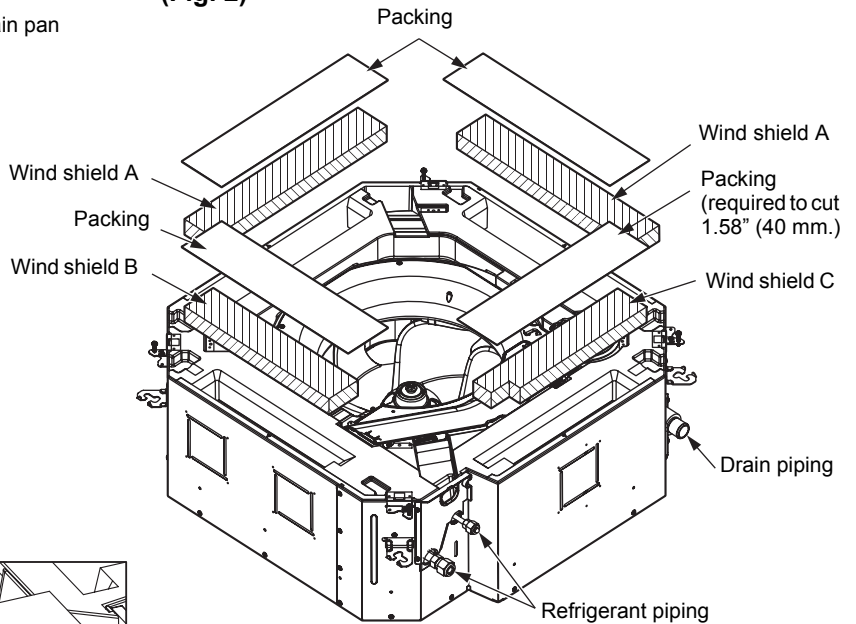

(Fig. 3)

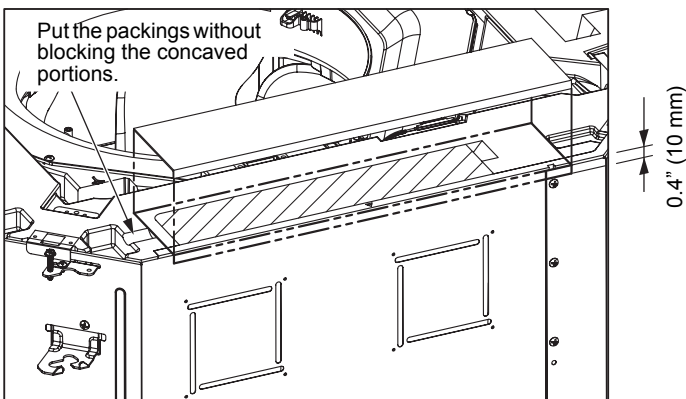

■ Installing the indoor unit

- Install the indoor unit (Install the indoor unit following the instructions described on the installation manual of the indoor unit.)
- Block the air flow outlets following the air flow blocking pattern shown in the table below when controlling 3-way or 2-way air flow.
- The blockage portions of the air flow outlet are specified depending on the models. Do not specify the blockage of the airflow outlet other than specified in the table below.

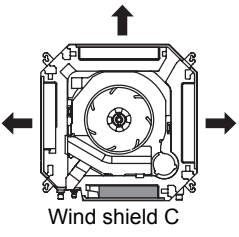
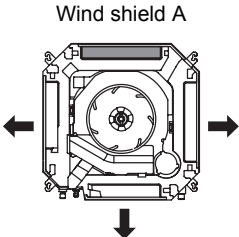
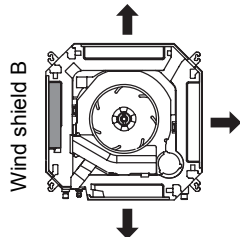
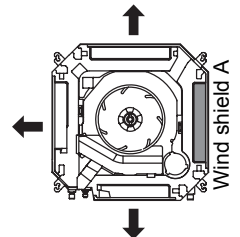
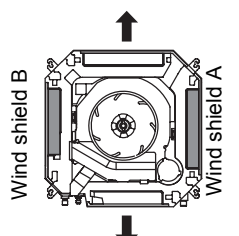
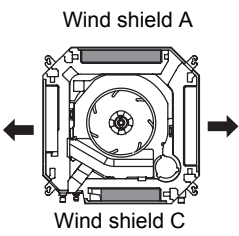
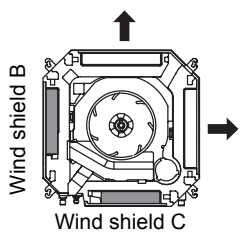
		Limited models only		
3-way air flow	 <p>Wind shield C</p>	 <p>Wind shield A</p>	 <p>Wind shield B</p>	 <p>Wind shield A</p>
	Available for all models	Available for all models	Available only for SP180 to SP240.	Available only for SP300 to SP420.
2-way air flow	 <p>Wind shield B Wind shield A</p>	 <p>Wind shield A Wind shield C</p>	 <p>Wind shield B Wind shield C</p>	
	Available for all models	Available for all models	Available for all models	

■ Changing the setting

- The setting is changed by using a wired remote controller. (For the details, Refer to “Changing procedure” described below.)
- Perform “■Setting the louver lock (Louver position fixing)”.

⚠ CAUTION

When the ceiling is higher than the specification, the fan control is required. So, in that case, perform the “high ceiling setting” other than the setting described below.

The setting should be performed according to the instructions described on the installation manual attached to the indoor unit.

“Changing procedure”: Change the setting while the device stops.

- 1** Push **SET** + **CL** + **TEST** buttons simultaneously for more than 4 sec.

The unit No. displayed at first shows the indoor unit address of the header unit in group control operation. The fan operation of the indoor unit (header unit), selected at this time, is carried out.

- 2** Every time when **UNIT LOUVER** (Left button) is pushed, the No. in the group control operation are displayed in order.

The fan operation of the indoor unit, selected at this time, is carried out.

- 3** Set the **CODE No.** **88** by using the **TEMP.** **▼** / **▲** button.

- 4** Set the setting data by pushing **TIME** **▼** / **▲** buttons for the **TIME** setting.

3-way air flow	00 60
2-way air flow	00 50

- 5** Push the **SET** button. (The setting completes if the setting data are displayed.)

When changing the setting of other indoor unit in the group control operation, return to **2**.

- 6** Pushing the **TEST** button enters to the normal stop status.

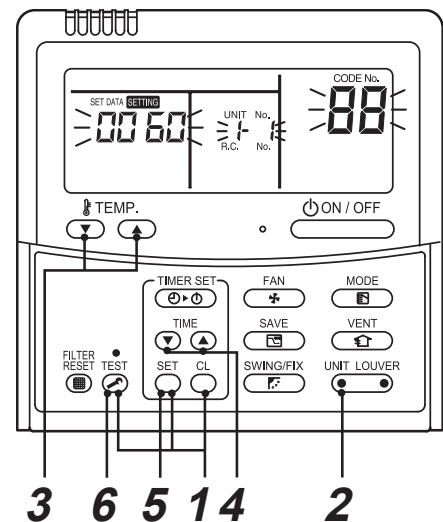

■ Setting the louver lock (Louver position fixing)

- Fix the louver at the air flow blockage portions. (For the setting methods, follow the procedures below.)

1 Push the LOUVER  (Right button) for more than 4 seconds while the air conditioner is stopped.

The **SETTING** blinks.

2 Push the UNIT  (Left button) to select the indoor unit you want to set.

Every time you push the button, the Unit No. changes.
The fan of the selected indoor unit starts its operation and the louvers swing.

3 Push the TEMP.  /  buttons to display the louver No. with the wind shield applied.

The selected louver starts to swing.

4 Select the code 0001 by pushing the TIME  /  buttons.

5 Push the  button to define the setting contents.

After the setting contents is defined, the  mark lights.
(Return to step 3 if there are other two wind shields.)

6 Push the  button to exit the setting.

“F1” is displayed in the CODE No. on the remote controller display.
This means that the 01 louver shown on the illustration is selected.

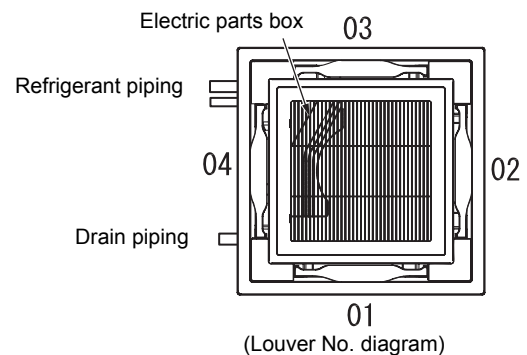
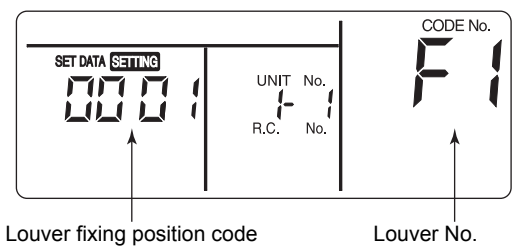
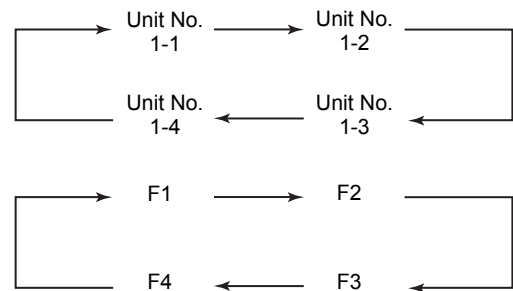

■ Confirming the installation

- After the installation completes, perform the test run to confirm that no abnormality is found.
- For your future reference, please keep the installation manual on your side.

TOSHIBA CARRIER CORPORATION

EH99678401