



# JVC

**D.I.S.T.**  
Digital Image Scaling Technology

InteriArt

**HV-36P38SJE**

**HV-32P37SJE**

**HV-28P37SJE**

*Natural Vision*

**T-V LINK**

**COLOUR TELEVISION**

**INSTRUCTIONS**



*plain English  
approved*

by the word centre

## ■ Warning

**DO NOT cut off the mains plug from this equipment.** If the plug fitted is not suitable for the power points in your home or the cable is too short to reach a power point, then obtain an appropriate safety approved extension lead or adaptor or consult your dealer.

If nonetheless the mains plug is cut off, remove the fuse and dispose of the plug immediately, to avoid a possible shock hazard by inadvertent connection to the mains supply.

If a new mains plug has to be fitted, then follow the instruction given below:

### Important

**Do not** make any connection to the larger terminal which is marked with the letter E or by the safety earth symbol  $\perp$  or coloured green or green-and-yellow.

The wires in the mains lead on this product are coloured in accordance with the following code:

Blue: Neutral

Brown: Live

As these colours may not correspond with the coloured marking identifying the terminals in your plug proceed as follows:

The wire which is coloured blue must be connected to the terminal which is marked with the letter N or coloured black.

The wire which is coloured brown must be connected to the terminal which is marked with the letter L or coloured red.

When replacing the fuse, use only a correctly rated approved type and always re-fit the fuse cover.

## ■ If in doubt — consult a competent electrician.

### How to replace the fuse

Open the fuse compartment with a blade screwdriver, and replace the fuse.

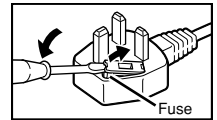

## ■ Guidelines for safe operation

This equipment has been designed and manufactured to comply with international safety standards. However, as with any electrical appliance, care must be taken to ensure optimal results and operational safety.

- Before attempting to use this equipment, read the operating instructions thoroughly.
- Ensure that all electrical connections (including the mains plug, extension leads, etc.) have been made in accordance with the manufacturer's instructions.
- If ever in doubt about the installation, operation or safety of this equipment, consult your dealer.
- Handle all glass panels or covers with care.
- Never operate this equipment if it appears damaged or operates abnormally. Turn the power off, disconnect the main power plug and consult your dealer.
- Never remove any affixed panels or covers. Doing so may result in electrical shock.
- Never leave this equipment operating unattended unless otherwise specifically stated that it is designed to do so or in standby mode. Only use the designated power switch to turn off the power and ensure that all potential users are instructed how to do so. Make special arrangements for infirm or handicapped persons.
- Never watch TV while operating a motor vehicle. It is illegal to watch TV while driving.
- Never listen to headphones at high volume. Doing so may damage your hearing.
- Never obstruct the ventilation of this equipment. Doing so may cause overheating and result in a malfunction or damage.
- Never use makeshift stands or attempt to affix legs with wood screws. When using a manufacturer's approved stand or legs, use only the fixtures provided and follow the installation instructions.
- Never allow this equipment to be exposed to rain or moisture.
- Never allow anyone, especially children, to insert anything into an opening in the case. Doing so may result in a fatal electrical shock.
- Never guess or take chances with electrical equipment of any kind. It is better to be safe than sorry.

Thank you for buying this JVC colour television.

To make sure you understand how to use your new TV, please read this manual thoroughly before you begin.

**WARNING: TO PREVENT FIRE OR SHOCK HAZARD, DO NOT EXPOSE THIS APPLIANCE TO RAIN OR MOISTURE.**

---

**CAUTION:**

- Operate only from the power source specified (AC 220 – 240 V, 50 Hz) on the unit.
- Avoid damaging the AC plug and power cord.
- When you are not using this unit for a long period of time, it is recommended that you disconnect the power cord from the main outlet.
- The main power button on the TV does not fully isolate the TV from the mains supply. If you are not going to use this TV for a long period of time, be sure to disconnect the mains plug from the mains outlet.

---

Avoid improper installation and never put the unit where good ventilation is not possible.

When installing this TV, distance recommendations must be maintained between the set and the wall, as well as inside a tightly enclosed area or piece of furniture.

Adhere to the minimum distance guidelines shown for safe operation.

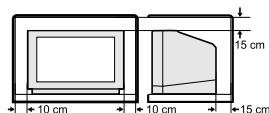

**Failure to heed the following precautions may result in damage to the TV or remote control.**

**DO NOT block the TV's ventilation openings or holes.**

(If the ventilation openings or holes are blocked by a newspaper or cloth, etc., the heat may not be able to get out.)

**DO NOT place anything on top of the TV.**

(such as cosmetics or medicines, flower vases, potted plants, cups, etc.)

**DO NOT allow objects or liquid into the cabinet openings.**

(If water or liquid is allowed to enter this equipment, fire or electric shock may be caused.)

**DO NOT place any naked flame sources, such as lighted candles, on the TV.**

The surface of the TV screen is easily damaged. Be very careful with it when handling the TV. Should the TV screen become soiled, wipe it with a soft dry cloth. Never rub it forcefully. Never use any cleaner or detergent on it.

In the event of a fault, unplug the unit and call a service technician. Do not attempt to repair it yourself or remove the rear cover.

---

**D.I.S.T. demonstration**

To start the D.I.S.T. demonstration:

Press the **MENU** button to display the menu bar. Then press the yellow button.

A picture split in two (D.I.S.T. turned on and D.I.S.T. turned off) will appear on the screen.

To quit the D.I.S.T. demonstration:

Press the yellow button, **TV** button, **P**  $\vee/\wedge$  buttons or any of the number buttons.

---

# CONTENTS

---

<b>Setting up your TV</b> .....	<b>5</b>	<b>SOUND menu</b> .....	<b>30</b>
Connecting the aerial and video cassette recorder (VCR) .....	5	STEREO / I • II .....	30
Connecting and placing the woofer unit (HV-36P38SJE only) .....	7	BASS .....	30
Connecting the power cord to the AC outlet .....	8	TREBLE .....	30
Putting the batteries into the remote control .....	8	BALANCE .....	30
Initial settings .....	8	HEADPHONE VOLUME .....	30
T-V LINK functions .....	12	3D CINEMA SOUND .....	30
<b>TV buttons and functions</b> .....	<b>13</b>	<b>FEATURES menu</b> .....	<b>31</b>
Turn the main power on .....	14	SLEEP TIMER .....	31
Turn the TV on from standby mode .....	14	CHILD LOCK .....	31
Choose a TV channel .....	14	APPEARANCE .....	32
Adjust the volume .....	14	BLUE BACK .....	32
<b>Remote control buttons and functions</b> .....	<b>15</b>	<b>SET UP menu</b> .....	<b>33</b>
Turn the TV on or off from standby mode ..	15	AUTO PROGRAM .....	33
Choose a TV channel and watch images from external devices .....	16	EDIT/MANUAL .....	33
Adjust the volume .....	17	LANGUAGE .....	38
Information function .....	17	PICTURE TILT .....	38
ZOOM function .....	18	DECODER (EXT-2) .....	38
3D CINEMA SOUND function .....	19	EXT SETTING .....	39
Return to TV channel instantly .....	19	<b>Additional preparation</b> .....	<b>42</b>
Using the FREEZE function .....	19	Connecting external equipment .....	42
Using the MULTI-PICTURE function .....	20	<b>Troubleshooting</b> .....	<b>45</b>
Operating a JVC brand VCR or DVD player .....	21	<b>Specifications</b> .....	<b>47</b>
<b>Teletext function</b> .....	<b>22</b>		
Basic operation .....	22		
Using the List Mode .....	22		
Hold .....	23		
Sub-page .....	23		
Reveal .....	23		
Size .....	23		
Index .....	23		
Cancel .....	24		
<b>Using the TV's menu</b> .....	<b>25</b>		
Basic operation .....	25		
<b>PICTURE menu</b> .....	<b>26</b>		
PICTURE MODE .....	26		
CONTRAST .....	26		
BRIGHT .....	26		
SHARP .....	26		
COLOUR .....	26		
HUE .....	26		
COLOUR TEMP .....	26		
FEATURES .....	27		

# Setting up your TV

## Caution

- Turn off all the equipment including the TV before connecting anything.

## Connecting the aerial and video cassette recorder (VCR)

- The connecting cables are not provided.
- For further details, refer to the manuals provided with the devices to be connected.

■ If you are connecting a VCR, follow ① → ② → ③ in the diagram opposite.

■ If you are not connecting a VCR, follow ①.

To use the T-V LINK functions, you must have a T-V LINK compatible VCR connected by a SCART cable ③ to the EXT-2 terminal on the TV. For details about T-V LINK functions, see “T-V LINK functions” on page 12.

- You can watch a video using the VCR without doing ③. For details, see your VCR instruction manual.
- To connect more equipment, please see “Connecting external equipment” on page 42.
- To connect additional audio equipment, see “Connecting speakers/amplifier” on page 44.
- If you connect a decoder to a T-V LINK compatible VCR, set the DECODER (EXT-2) function to ON. For details, see “DECODER (EXT-2)” on page 38. Otherwise, you will not be able to watch scrambled channels.

HV-36P38SJE

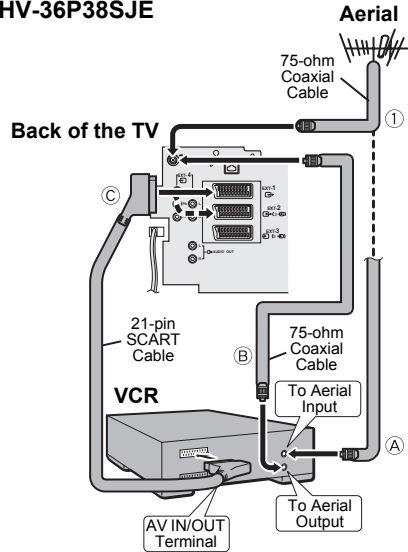

HV-32P37SJE/HV-28P37SJE

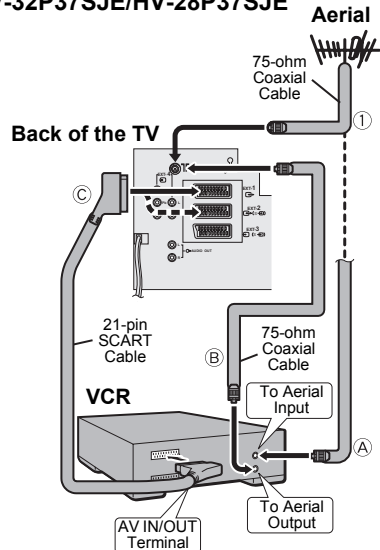

## ■ Rear Panel HV-36P38SJE

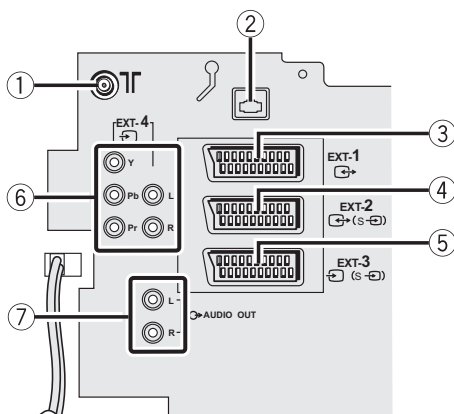

- ① Aerial socket (page 5)
- ② Woofer terminal (pages 7)
- ③ EXT-1 terminal (pages 5, 39, 42)
- ④ EXT-2 terminal (pages 5, 12, 39, 42)
- ⑤ EXT-3 terminal (pages 39, 42)
- ⑥ EXT-4 terminal (pages 39, 42)
- ⑦ AUDIO OUT terminal (page 44)

## HV-32P37SJE/HV-28P37SJE

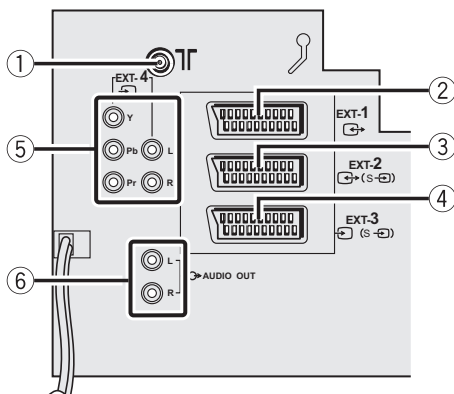

- ① Aerial socket (page 5)
- ② EXT-1 terminal (pages 5, 39, 42)
- ③ EXT-2 terminal (pages 5, 12, 39, 42)
- ④ EXT-3 terminal (pages 39, 42)
- ⑤ EXT-4 terminal (pages 39, 42)
- ⑥ AUDIO OUT terminal (page 44)

## Connecting and placing the woofer unit (HV-36P38SJE only)

Connect the supplied woofer connector to the woofer terminal on the back of the TV.  
If the woofer unit is not connected, you will not be able to enjoy the bass sound.

- Connect so that the lever is raised.

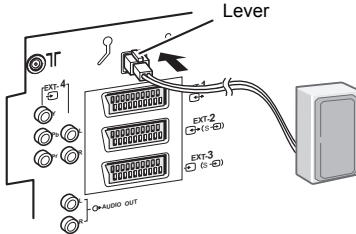

- When disconnecting the woofer connector, do so while pushing the lever.

### ■ Placing the woofer unit

**As shown in the diagram, fix the supplied stoppers to the four corners of the side of the woofer unit that will be used as the base.**

The woofer unit can be used either standing up or lying down.

There is no difference between the top and bottom of the woofer unit irrespective of whether it is being used standing up or lying down.

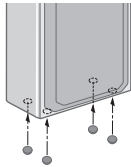

### Place the woofer unit within the range of the connection cable.

It is recommended that the woofer unit be placed with the speaker facing forwards.

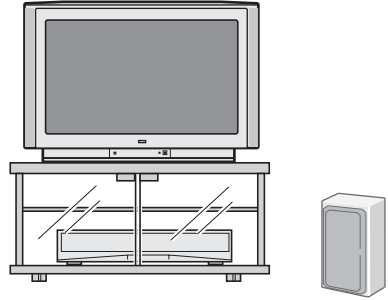

### Pay attention to the following in order to prevent unnatural colours from appearing in the corner of the screen.

- Place the woofer unit at least 20 cm away from either side of the TV.
- Do not place the woofer unit on top of the TV.
- When the TV is used on a TV stand or table, do not place the woofer unit underneath the TV.

## Connecting the power cord to the AC outlet

### Caution

- Operate only from the power source specified (AC 220 – 240 V, 50 Hz) on the unit.

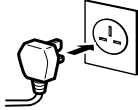

## Putting the batteries into the remote control

Use two AA/R6 dry cell batteries. Insert the batteries from the ⊖ end, making sure the ⊕ and ⊖ polarities are correct.

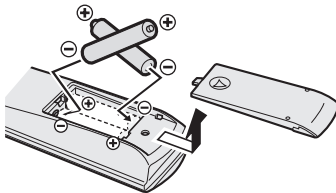

- Follow the warnings printed on the batteries.
- Battery life is about six months to one year, depending on how much you use the remote control.
- The batteries we supply are only for setting up and testing your TV, please replace them as soon as you need to.
- If the remote control does not work properly, replace the batteries.

## Initial settings

When the TV is first turned on, it goes into the initial settings mode, and you will see the JVC logo. Follow the instructions on the screen display to make the initial settings.

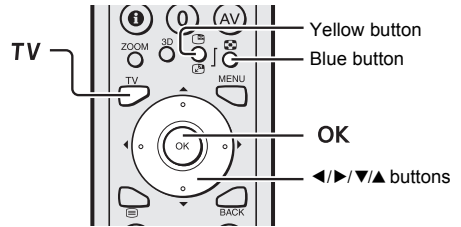

### 1 Press the main power button on the TV

The power lamp lights red (for power on), then green (for TV on) and the JVC logo appears.

#### HV-36P38SJE

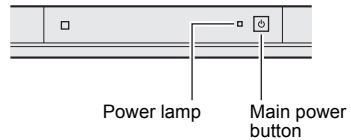

#### HV-32P37SJE/HV-28P37SJE

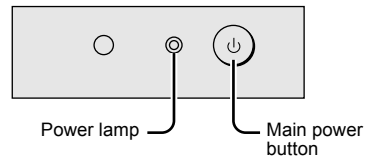

- If the power lamp stays red and does not change to green:  
Your TV is in the standby mode. To turn the TV on, set the VCR/TV/DVD switch on the remote control to the TV position and press the ⏻/I button. (See page 15.)



- If the JVC logo does not appear this is because your TV has already been turned on for the first time: use the “LANGUAGE” and “AUTO PROGRAM” functions to make the initial settings. For details, see “SET UP menu” on page 33.

## 2 Press the OK button

The LANGUAGE menu appears.



D0002(E)-EN

## 3 Press the ▼/▲ buttons to choose ENGLISH. Then press the OK button

The on-screen display will then be in English.

The COUNTRY menu appears as a sub-menu of the AUTO PROGRAM function.

There are two COUNTRY menus.

Pressing the yellow button changes the COUNTRY menu as follows:

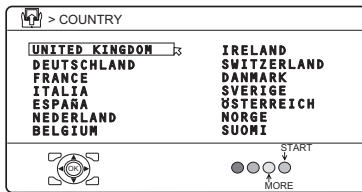

D0003-EN

## 4 Press the ◀/▶ and ▼/▲ buttons to choose the country where you are

- To receive SKY 1 you need a satellite tuner. You must have the satellite tuner set to SKY 1 before starting the AUTO PROGRAM function which follows.

## 5 Press the blue button to start the AUTO PROGRAM function

The AUTO PROGRAM menu appears and received TV channels are automatically stored in the programme numbers (PR).

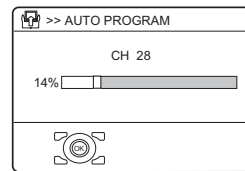

D0004-EN

- Perform the “ACI function” operation (see page 10) when “ACI START/ACI SKIP” is displayed.
- To cancel the AUTO PROGRAM function: Press the TV button.



After the TV channels have been registered in the programme numbers (PR), the EDIT menu appears

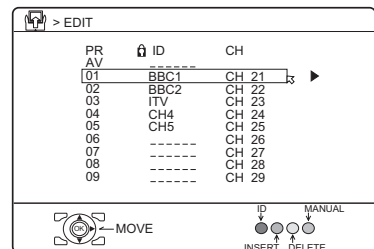

D0038-EK

- If you want to, you can now edit the programme numbers (PR) using the EDIT/MANUAL function. For details, see “EDIT/MANUAL” on page 33.
- If you do not want to edit programme numbers (PR), go to the next step.

### 6 Press the **OK** button to display the **T-V LINK** menu

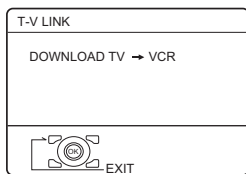

#### If you do not have a T-V LINK compatible VCR connected:

Press the **TV** button to exit the T-V LINK menu.

The T-V LINK menu disappears.

#### If you have a T-V LINK compatible VCR connected to the EXT-2 terminal:

Follow the operating procedure “Downloading the data to VCR” on page 11 to transmit the Programme number (PR) data.

### Now, the initial settings are complete, and you can watch the TV

- **When the COUNTRY setting is UNITED KINGDOM:**  
BBC1, BBC2, ITV, Channel 4 and Channel 5 are automatically set to the programme numbers PR1 to PR5. If the TV doesn't receive one of these TV channels, that programme number (PR) will not be set. Programme number PR6 is not normally set.
- **When the COUNTRY setting is IRELAND:**  
If your TV can detect the TV channel name from the TV channel broadcast signal, the TV channel name is assigned to the programme number (PR) to which the TV channel has been set. However, which TV channels are set to which programme numbers (PR) will depend on the area in which you live.
- If a TV channel you want to view is not set to a programme number (PR), you can set it using the **MANUAL** function. For details, see “EDIT/MANUAL” on page 33.

- The **AUTO PROGRAM** function does not set the programme number PR 0 (AV) for your video cassette recorder. You will need to set this using the **MANUAL** function.
- In some areas you may get TV reception from more than one transmitter, for example different ITV regions. In this case each TV channel could be set twice. If this happens, the first set of channels will have the stronger signal. If you want to delete the second set of channels, you will have to do it manually (see page 33).

#### For users in the UK:

If you have any problems setting up your new TV, please call the **JVC** Helpline on **0870 330 5000**.

#### For users in the Republic of Ireland:

If you have any problems setting up your new TV, please call the **JVC** Helpline on **1890-582500**.

### ■ **ACI function**

This TV has an ACI function which decodes the ACI (Automatic Channel Installation) data.

Using the ACI function allows all TV channels transmitted from the cable TV station to be properly registered quickly according to the data from the cable TV station.

#### If “**ACI START/ACI SKIP**” appears in the **AUTO PROGRAM** menu:

You can use the ACI (Automatic Channel Installation) function to decode the ACI data and complete the registration of all the TV channels in a short period of time.

#### Press the **▼/▲** buttons to choose **ACI START**. Then press the **OK** button to start the ACI function

Depending on your cable TV station, there may be a broadcast selection menu set up by the cable TV station.

Follow the menu instructions and use the **◀/▶** and **▼/▲** buttons to operate the menu. After you have made the setting, press the **OK** button.

- If you have any questions about the items in the Broadcast Selection menu or how to operate the menu, please contact your cable TV station.
- If you don't want to use the ACI function, press the ▼/▲ buttons to choose ACI SKIP and then press **OK**.
- When the cable TV broadcast reception is poor, the ACI function will not work properly.
- If there is an error in the ACI data itself, the TV channel cannot be registered properly. If this happens, turn the ACI function off (ACI SKIP) and use the AUTO PROGRAM function. Alternatively, use the EDIT/MANUAL function to correct the Programme number (PR) setting.

#### If "ACI ERROR" is displayed in the AUTO PROGRAM menu:

"ACI ERROR" means that the ACI function is not working properly. Press the ◀ button to start the ACI function again.

If "ACI ERROR" still appears even after you have tried to start the ACI function several times, press the ▶ button to start the AUTO PROGRAM function. It does not cause any problem because all the TV channels are registered to the Programme numbers (PR) by the AUTO PROGRAM function.

#### ■ Downloading the data to VCR

You can transmit to the latest Programme numbers (PR) data to a VCR with the T-V LINK function.

#### Caution

- This only works when a T-V LINK compatible VCR is connected to the EXT-2 terminal.
- This only works when the T-V LINK menu is being displayed.

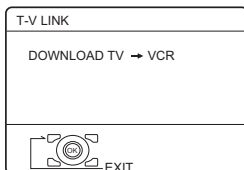

D0005-EN

## 1 Turn on the VCR

### 2 Press the **OK** button

The data transmission begins.

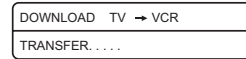

D0037-EN

The T-V LINK menu disappears once the data transmission ends.

#### When the T-V LINK menu is changed over to another menu:

The TV has finished its menu. This new menu is operated from the VCR. See the VCR instruction manual for what to do next.

#### If "FEATURE NOT AVAILABLE" appears at the T-V LINK menu:

Check the following three items. Then press the ◀ button to retry data transmission.

- Has a T-V LINK compatible VCR been connected to the EXT-2 terminal?
- Has the VCR power been turned on?
- Does the SCART cable that is connected to the EXT-2 terminal to T-V LINK compatible VCR have all its proper connections?

---

## T-V LINK functions

---

When you have a T-V LINK compatible VCR connected to the EXT-2 Terminal on the TV, it is easier to set up the VCR and to view videos. T-V LINK uses the following features:

### To use T-V LINK functions:

A “T-V LINK compatible VCR” means a JVC video cassette recorder with the T-V LINK logo, or with one of the following logos. However, these VCRs may support some or all of the features described earlier. For details, see your VCR instruction manual.

“Q-LINK” (a trademark of Panasonic Corporation)

“Data Logic” (a trademark of Metz Corporation)

“Easy Link” (a trademark of Phillips Corporation)

“Megalogic” (a trademark of Grundig Corporation)

“SMARTLINK” (a trademark of Sony Corporation).

### ■ Pre-set download

The VCR will automatically download the registered data on the TV channels from the TV. This means you do not need to set up the program channels on your VCR manually. The preset download function automatically begins when the initial setting is complete or whenever you carry out the AUTO PROGRAM or EDIT/MANUAL functions.

You can also carry out this function using your VCR controls.

### When “FEATURE NOT AVAILABLE” is displayed:

If “FEATURE NOT AVAILABLE” is displayed, the download was not performed correctly. Before trying to download again, check that:

- the VCR power is turned on
- the VCR is T-V LINK compatible
- the VCR is connected to the EXT-2 terminal
- the SCART cable is fully wired.

### ■ Direct Rec

“What You See Is What You Record”

You can easily record to VCR the images that you are watching on the TV.

For details, read the manual for your VCR. Use your VCR controls. “VCR IS RECORDING” is displayed.

**In the following situations, the VCR will stop recording if the TV is turned off, if the TV channel or input is changed, or if the menu is displayed on the TV:**

- when recording images from an external device connected to the TV (for example a camcorder)
- when recording a TV channel after it has been unscrambled on a decoder
- when recording a TV channel by using the TV’s output because the VCR’s own tuner cannot properly receive that channel.

When the VCR is not ready (for example when there is no tape inserted), “NO RECORDING” is displayed.

You cannot carry out Direct Rec using your TV’s control.

Generally, the VCR cannot record a TV channel that it cannot receive properly on its own tuner, even if you can view that TV channel on the TV. However, some VCRs can record a TV channel by using the TV’s output if that channel can be viewed on the TV. For details, see your VCR instruction manual.

# TV buttons and functions

## HV-36P38SJE

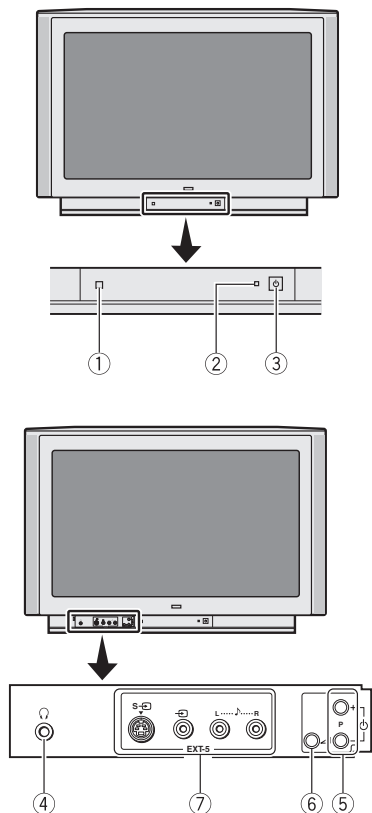

See the pages in parentheses for details.

- ① Remote control sensor
- ② Power lamp (pages 8, 14)
- ③ Main power button (pages 8, 14)
- ④ Headphone jack (mini jack) (page 42)
- ⑤ P  $\nabla/\wedge$  buttons/  $-/+$  buttons (page 14)
- ⑥  $\blacktriangleleft$  (Volume) button (page 14)
- ⑦ EXT-5 terminal (pages 39, 42)

## HV-32P37SJE/HV-28P37SJE

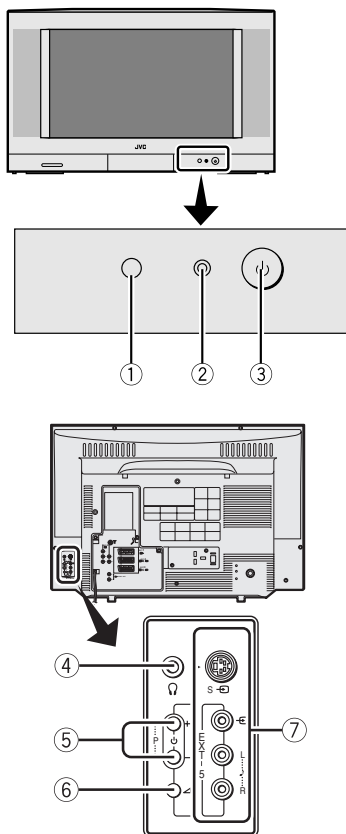

See the pages in parentheses for details.

- ① Remote control sensor
- ② Power lamp (pages 8, 14)
- ③ Main power button (pages 8, 14)
- ④ Headphone jack (mini jack) (page 42)
- ⑤ P  $\nabla/\wedge$  buttons/  $-/+$  buttons (page 14)
- ⑥  $\blacktriangleleft$  (Volume) button (page 14)
- ⑦ EXT-5 terminal (pages 39, 42)

---

## Turn the main power on

---

**Press the main power button on the TV.**

The power lamp lights red and your TV is in standby mode.

- If the power lamp lights green, the TV is already on.

**To turn the main power off:**

Press the main power button again.

The power lamp goes off.

### Caution

- The main power button on the TV does not fully isolate the TV from the AC supply. If you are not going to use the TV for a long period, be sure to disconnect the AC plug from the AC socket.

---

## Turn the TV on from standby mode

---

**Press the P  $\nabla/\wedge$  buttons to turn the TV on from standby mode**

---

## Choose a TV channel

---

**Press the P  $\nabla/\wedge$  buttons to choose a programme number (PR) or an EXT terminal**

---

## Adjust the volume

---

**1 Press the  $\triangleleft$  (Volume) button**

The volume level indicator appears.

---

**2 Press the  $-/+$  buttons while the volume level indicator is displayed**

# Remote control buttons and functions

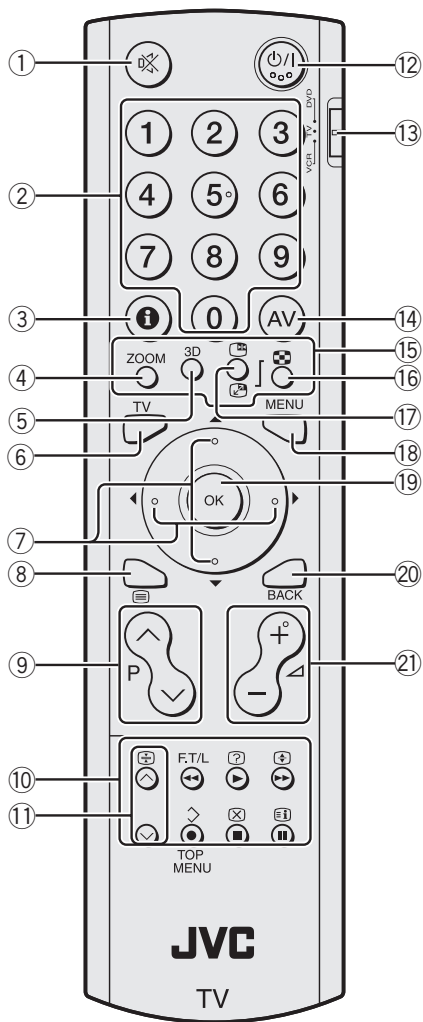

- ① Muting button
- ② Number buttons
- ③ Information button
- ④ **ZOOM** button
- ⑤ **3D** sound button
- ⑥ **TV** button
- ⑦ ◀/▶/▼/▲ buttons
- ⑧ ≡ (Text) button
- ⑨ **P** ∨/∧ buttons
- ⑩ VCR/DVD/Teletext control buttons
- ⑪ ∨/∧ buttons
- ⑫ ⏻/⏼ (Standby) button
- ⑬ VCR/TV/DVD switch
- ⑭ **AV** button
- ⑮ Colour button
- ⑯ **Colour** button
- ⑰ **Multi** button
- ⑱ **Freeze/Swap** button
- ⑲ **MENU** button
- ⑲ **OK** button
- ⑲ **BACK** button
- ⑲ ◀ (Volume) -/+ buttons

## Turn the TV on or off from standby mode

Press the ⏻/⏼ (standby) button to turn the TV on or off.

When the TV is turned on, the power lamp changes from red to green.

- The power can be turned on by pressing the **TV** button, **P** ∨/∧ buttons or Number buttons.

To turn the TV on or off, set the VCR/TV/DVD switch on the remote control to the TV position and press the ⏻/⏼ button. If the VCR/TV/DVD switch on the remote control is set to a position other than TV, the TV will not be turned on or off even if the ⏻/⏼ button is pressed.

## Choose a TV channel and watch images from external devices

- If the picture is tilted, correct it. See “PICTURE TILT” on page 38.

### ■ Use the number buttons: Enter the programme number (PR) of the channel using the number buttons.

Example:

- PR 6 → press **6**
- PR 12 → press **1** and **2**

### ■ Use the **P** $\nabla/\blacktriangle$ buttons: Press the **P** $\nabla/\blacktriangle$ buttons to choose the programme number (PR) you want or an EXT terminal.

### ■ Use the AV button: Press the AV button to choose an EXT terminal.

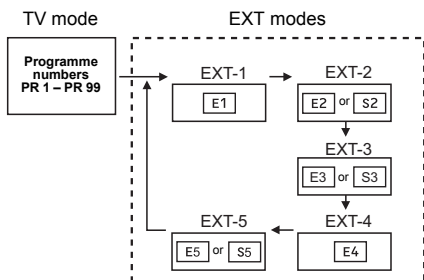

- You can choose a video input signal from the S-VIDEO signal (Y/C signal) and regular video signal (composite signal). For details, see “S-IN (S-VIDEO input)” on page 39.
- If you do not have a clear picture or no colour appears, change the colour system manually. See “COLOUR SYSTEM” on page 28.
- If you choose an EXT terminal with no input signal, the EXT terminal number becomes fixed on the screen.

- This TV set has a function which can automatically change over the input according to a special signal output from an external device. (The EXT-4 and EXT-5 terminals do not support this function.)
- Since this TV is designed to make full use of the resolution of the original video source, the motion may appear unnatural when the video source is input with 625p progressive-scanning component signals. If this happens, change the output setting of the connected device to 625i interlace-scanning component signal output. See the instructions that came with the device for more information.

### To return to a TV channel:

Press the **TV** button, the  $\nabla/\blacktriangle$  buttons or the number buttons.

### To use the programme number PR 0 (AV):

When the TV and VCR are connected only by the aerial cable, choosing the programme number PR 0 (AV) allows you to view images from the VCR. Set the VCR RF channel to the programme number PR 0 (AV) manually. For details, see “EDIT/MANUAL” on page 33.

Pressing the **AV** button changes the choice as follows:

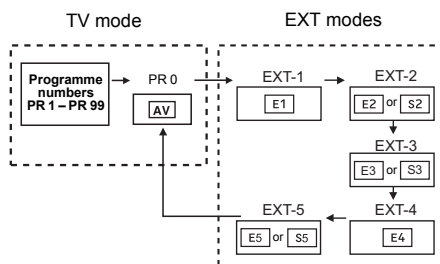

- The VCR sends its playback image along the aerial cable as an RF (radio frequency) signal.
- Also see your VCR instruction manual.



## Adjust the volume

Press the buttons to adjust the volume.

The volume indicator appears and the volume changes as you press the buttons.

### ■ Muting the sound

Press the (muting) button to turn off the sound.

Pressing the (muting) button again restores the previous volume level.

## Information function

You can see the channel number of the programme you are watching, the current time or the PR LIST.

From the PR LIST, you can choose a channel or EXT terminal.

Press the (Information) button to display the information you want to see.

Pressing the (Information) button changes the display as follows:

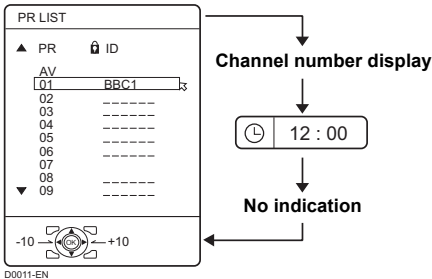

### Channel number display:

The channel number and channel name (when the channel name is registered) of the programme you are watching or the EXT terminal number is displayed.

### Time display:

The current time of the teletext data is displayed.

If the TV has not received a TV channel that has teletext programmes since it was turned on, the time display is blank. To view the current time, choose a TV channel that has teletext programmes. The time will continue to be displayed until the TV is turned off even if you choose other TV channels.

- An incorrect current time is sometimes displayed when watching videos.

### PR LIST:

The programme number (PR) and EXT terminal list is displayed.

Pressing the **OK** button after choosing the programme number (PR) or EXT terminal with the buttons will display the chosen programme or EXT terminal.

- For programme numbers (PR) for which the CHILD LOCK function is set, the (CHILD LOCK) mark is displayed. For details see “CHILD LOCK” on page 31.

## ZOOM function

You can change the screen size according to the picture aspect ratio. Choose the optimum one from the following ZOOM modes.

### AUTO:

When a WSS (Wide Screen Signalling) signal, which shows the aspect ratio of the picture, is included in the broadcast signal or the signal from an external device, the TV automatically changes the ZOOM mode to 16:9 ZOOM mode or FULL mode according to the WSS signal.

If a WSS signal is not included, the picture is displayed according to the ZOOM mode set with the 4:3 AUTO ASPECT function.

- For details of the 4:3 AUTO ASPECT function, see “4:3 AUTO ASPECT” on page 29.
- When the AUTO (WSS) mode does not function correctly due to poor WSS signal quality or when you want to change the ZOOM mode, press the **ZOOM** button and change to another ZOOM mode.

### REGULAR:

Use to view a normal picture (4:3 aspect ratio) as this is its original shape.



### PANORAMIC:

This stretches the left and right sides of a normal picture (4:3 aspect ratio) to fill the screen, without making the picture appear unnatural.



- The top and bottom of the picture are slightly cut off.

### 14:9 ZOOM:

This zooms up the wide picture (14:9 aspect ratio) to the upper and lower limits of the screen.



### 16:9 ZOOM:

This zooms up the wide picture (16:9 aspect ratio) to the full screen.



### 16:9 ZOOM SUBTITLE:

This zooms up the wide picture (16:9 aspect ratio) with subtitles to the full screen.

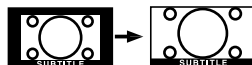

### FULL:

This uniformly stretches the left and right sides of a normal picture (4:3 aspect ratio) to fill the wide TV screen.

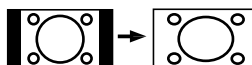

- For 16:9 aspect ratio pictures that have been squeezed into a normal picture (4:3 aspect ratio), use the FULL mode to restore the picture to its original shape.

## ■ Choose the ZOOM mode

### 1 Press the ZOOM button to display the ZOOM menu

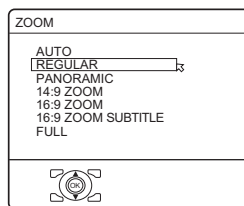

D0009-EN

### 2 Press the ▼/▲ buttons to choose a ZOOM mode. Then press the OK button

The picture expands and the chosen ZOOM mode is displayed in about 5 seconds.

- The ZOOM mode may be automatically changed by the control signal from an external device. When you want to return to the previous ZOOM mode, choose the ZOOM mode again.

## ■ Adjusting the visible area of the picture

If subtitles or the top (or bottom) of the picture are cut off, you can adjust the visible area of the picture manually.

### 1 Press the **ZOOM** button

The ZOOM menu appears.

### 2 Press the **OK** button to display the **ZOOM** mode indicator

The indicator appears.



D0010-EN

### 3 While it is displayed, press the **▼/▲** buttons to change the position of the picture

- You cannot adjust the visible area in REGULAR or FULL mode.

## 3D CINEMA SOUND function

You can enjoy sounds with a wider ambience.

- This function does not work for the sound from headphones.

**Press the 3D button and choose "ON", "MONO" or "OFF".**

### **ON:**

Choose to add the 3D CINEMA SOUND effect to stereo sound.

### **MONO:**

Choose to add the 3D CINEMA SOUND effect to mono sound.

### **OFF:**

Choose to cancel the 3D CINEMA SOUND effect.

- The 3D CINEMA SOUND effect can be adjusted with the "3D CINEMA SOUND" menu (see page 30).

## Return to TV channel instantly

You can return to a TV channel instantly.

### **Press the TV button**

The TV returns to the TV mode and a TV channel appears.

## Using the FREEZE function

You can view the current programme as a still picture.

### 1 Press the **FREEZE** button

The still picture of the current picture will appear.

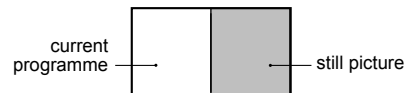

D0056-EN

### To cancel the FREEZE function:

Press the button, the **P**  $\nabla/\wedge$  buttons or the number buttons.

- The FREEZE function does not work while a sub-picture is displayed.
- The still picture cannot be output from the TV.
- The FREEZE function does not work for pictures of 625p, 525p and 1125i signals.

## Using the MULTI-PICTURE function

### 1 Press the button

The MULTI-PICTURE menu appears.

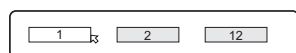

D0101-EN

### 2 Press the $\leftarrow/\rightarrow$ buttons to choose the number of screens and then press the OK button

Choose to return to one screen.

D0102

Choose to change to 2-pictures multi.

D0103

Choose to change to 12-pictures multi.

D0104

### 2-pictures multi:

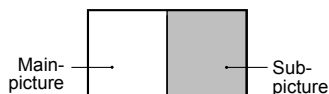

D0056-EN

### 12-pictures multi:

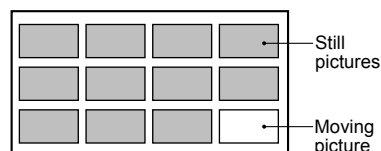





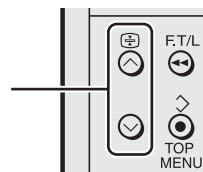

D0058-EN

- When set to 2-pictures multi, you can view a TV picture and a picture from an external device. You can not view a TV picture on more than one screen at the same time.
- When 12-pictures multi is set, pictures from external devices are not displayed.
- When set to 2-pictures multi, the main-picture can be changed by pressing the **P**  $\nabla/\wedge$  buttons. The sub-picture screen can be changed by pressing the  $\nabla/\wedge$  buttons.  
When set to 12-pictures multi and there are more than 12 pictures, the next or previous 12 screens can be displayed by pressing the  $\nabla/\wedge$  buttons.



Changing the sub-picture  
Displaying the next or  
previous 12 screens



- When set to 2-pictures multi, press the (swap) button to switch the main-picture and sub-picture.
- 2-pictures multi function does not work for a picture of 1125i signal.
- A picture of 625p or 525p signal cannot be displayed as the sub-picture. Pay attention to the following.
  - When the EXT-4 picture is a picture of 625p or 525p signal, you cannot choose EXT-4 with the  $\nabla/\wedge$  buttons.
  - When the EXT-4 picture signal is changed to 625p, 525p or 1125i signal while the EXT-4 picture is displayed as the sub-picture, the 2-pictures multi function is cancelled.

- The pictures cannot be swapped when a picture of 625p or 525p signal from EXT-4 is being displayed as the main picture.
- Do not press the  (swap) button while you are recording the TV output on the VCR. If you do, the TV output signal will change.
- You cannot view a scrambled channel in the sub-picture. If the  (swap) button is pressed when viewing a scrambled channel in the main-picture using an external decoder, the channel you have been viewing in the sub-picture will appear in both the main-picture and sub-picture.
- When set to 2-pictures multi and the headphones are connected, the sound for the main-picture is output from the TV speakers and the sound from the sub-picture is output from the headphones.
  - Adjust the volume of the sub-picture sound from the headphones with “HEADPHONE VOLUME” in the “SOUND” menu (see page 30).
  - The main-picture sound can not be heard through the headphones.
- When set to 12-pictures multi, press the /// buttons to choose the screen you want to view and the press the **OK** button to display that picture on the whole screen.
- The BLUE BACK function does not work when the MULTI-PICTURE function is being used.
- The ZOOM function does not work when the MULTI-PICTURE function is being used.

### To return the multi-picture to one screen:

Press the **MULTI** button, press the / buttons to choose one screen, and then press the **OK** button.

- Pressing the **TV** button will also return the display to one screen.

## Operating a JVC brand VCR or DVD player

These buttons will operate a JVC brand VCR or DVD player. Pressing a button that looks the same as the device’s original remote control button has the same effect as the original remote control.

### 1 Set the VCR/TV/DVD Switch to the VCR or DVD position

#### VCR:

When you are operating the VCR, set the switch to the VCR position.







- You can turn the VCR on or off with the /I (standby) button.

#### DVD:

When you are operating the DVD player, set the switch to the DVD position.

- You can turn the DVD player on or off with the /I (standby) button.

### 2 Press the VCR/DVD Control Button to control your VCR or DVD player

- If your device is not made by JVC, these buttons will not work.
- Even if your device is made by JVC, some of these buttons may not work, depending on the device you are using.
- You can use the / buttons to choose a TV channel the VCR will receive, or choose the chapter the DVD player plays back.
- Some models of DVD player use the / buttons for both operating the fast forward/backward functions and for choosing the chapter. In this case, the / buttons do not work.

You cannot turn the TV on or off when the VCR/TV/DVD switch is set to the VCR or DVD position.

When you turn the TV on or off, set the VCR/TV/DVD switch to the TV position.

# Teletext function

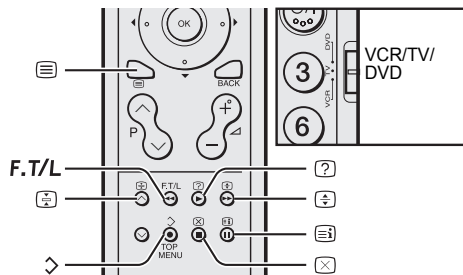

## Basic operation

You can view three types of teletext broadcasts on the TV:

FLOF (Fastext), TOP and WST.

- TOP is not available when the COUNTRY setting is UNITED KINGDOM.

### 1 Choose a TV channel with a teletext broadcast

### 2 Set the VCR/TV/DVD switch to the TV position



### 3 Press (Text) button to display the teletext

Pressing  (Text) button changes the mode as follows:

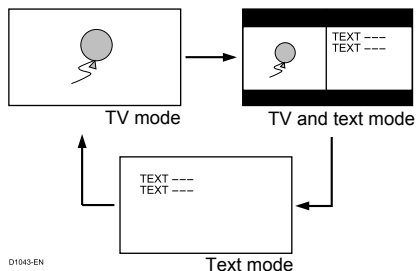

01045-EN

### 4 Choose a teletext page by pressing the **P** buttons, number buttons or colour buttons

**To return to the TV mode:**

Press the **TV** button or  (Text) button.

- If you have trouble receiving teletext broadcasts, consult your local dealer or the teletext station.
- The ZOOM function will not work in the TV and text mode or Text mode.
- You cannot operate menus when viewing a teletext programme.
- Language display depends on the country which was set on the COUNTRY menu. If characters do not appear properly, change the COUNTRY setting to other country's. To change the COUNTRY setting, perform steps 1 and 2 of the "AUTO PROGRAM" procedure on page 33 and then press the **OK** button.

## Using the List Mode

You can store the numbers of your favourite teletext pages in memory and call them up quickly using the colour buttons.

### ■ To store the page numbers:

#### 1 Press **F.T/L** button to go into the List mode

The page numbers you have stored are displayed at the bottom of the screen.

#### 2 Press a colour button to choose a position. Then press the number buttons to enter the page number

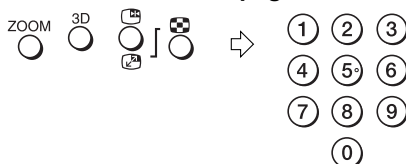

### 3 Press and hold down the $\triangleright$ (Store) button

The four page numbers blink white to show that they are stored in memory.

## ■ To call up a stored page:

### 1 Press the **F.T/L** button to enter the List mode

### 2 Press a colour button having a stored page

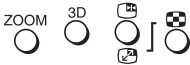

#### To exit the List mode:

Press the **F.T/L** button again.

## Hold

You can hold a teletext page on the screen for as long as you want, even while several other teletext pages are being received.

### Press the $\text{☐}$ (Hold) button

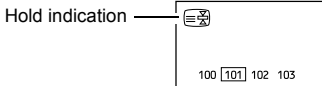

#### To cancel the Hold function:

Press  $\text{☐}$  (Hold) button again.

## Sub-page

Some teletext pages include sub-pages that are automatically displayed.

### 1 Choose a teletext page that includes sub-pages

Sub-page numbers that can be viewed are automatically displayed at the top of the screen.

### 2 Press the $\blacktriangleleft/\blacktriangleright$ buttons to choose a sub-page number

## Reveal

Some teletext pages include hidden text (such as answers to a quiz).

You can display the hidden text.

### Each time you press the $\text{?}$ (Reveal) button, text is hidden or revealed

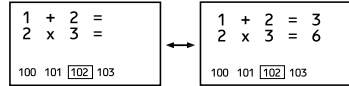

## Size

You can double the height of the teletext display.

### Press the $\text{☐}$ (Size) button

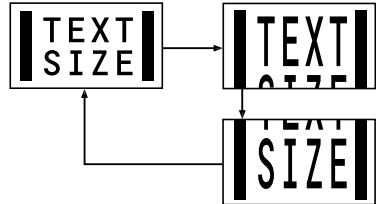

## Index

You can return to the index page instantly.

### Press the $\text{☐}$ (Index) button

Returns to page 100 or a previously specified page.

---

## Cancel

---

You can search for a teletext page while watching TV.

---

### 1 Press the number button to enter a page number, or press a colour button

The TV searches for a teletext page.

---

### 2 Press (Cancel) button

The TV programme appears. When the TV finds the teletext page, its page number appears in the upper left of the screen.

---

### 3 Press (Cancel) button to return to a teletext page when the page number is on the screen

- The TV mode cannot be resumed by pressing the  (Cancel) button. To return to the TV mode press **TV**.



# Using the TV's menu

This TV has a number of functions you can operate using menus. To use all your TV's functions, you need to understand the basic menu operating techniques fully.

## Buttons used to operate the menus

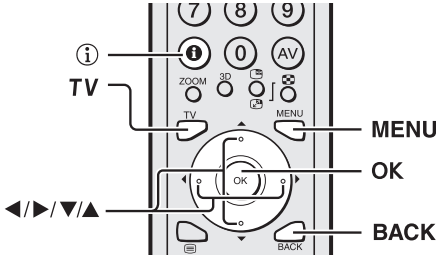

## Basic operation

- 1 Press the **MENU** button to display the menu bar



- 2 Press the **◀/▶** buttons to choose the menu you want to use and then press the **OK** button



- 3 Press the **▼/▲** buttons to choose the item to be set, press the **◀/▶** buttons to set the item, and then press the **OK** button

If there are sub-menus, use the **◀/▶/▼/▲** buttons to operate them.

- Press the **BACK** button to return to the previous menu.
- Press the **TV** or **MENU** button to exit from the menu.

## Types of menu



**PICTURE menu**  
Choose to set the screen settings.



**SOUND menu**  
Choose to set the sound settings.



**FEATURES menu**  
Choose to set the sleep timer and child lock settings.



**SET UP menu**  
Choose to edit the channels or set the display language settings.

The menu guide area can be made to appear and disappear for some menus. While the menu is displayed, press the **i** button to change between the guide area being displayed and not displayed.

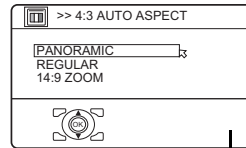

Guide area

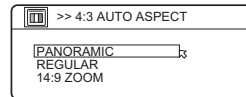

- The guide area for some menus will still be displayed even if the **i** button is pressed. This is not a fault.

# PICTURE menu

---

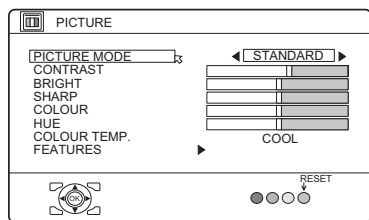

D0014-EN

- While the PICTURE menu is displayed, pressing the blue button will set the CONTRAST, BRIGHT, SHARP, COLOUR, HUE settings to their default settings.

---

## PICTURE MODE

You can choose one of three PICTURE MODEs to adjust the picture settings automatically.

### **BRIGHT:**

Heightens contrast and sharpness.

### **STANDARD:**

Standardizes picture adjustment.

### **SOFT:**

Softens contrast and sharpness.

---

## CONTRAST

You can adjust the picture contrast.

- ◀ : lower
- ▶ : higher

---

## BRIGHT

You can adjust the picture brightness.

- ◀ : darker
- ▶ : brighter

---

## SHARP

You can adjust the picture sharpness.

- ◀ : softer
- ▶ : sharper

---

## COLOUR

You can adjust the picture colour.

- ◀ : lighter
- ▶ : deeper

---

## HUE

You can adjust the picture tint.

- ◀ : reddish
- ▶ : greenish
- You can change the HUE setting (picture hue) when the colour system is NTSC 3.58, or NTSC 4.43.

---

## COLOUR TEMP.

You can select one of three COLOUR TEMP. modes (three tones of white) to adjust the white balance of the picture. Since white is the colour which is used as a reference for all the other colours, changing the COLOUR TEMP. mode affects the appearance of all the other colours on the screen.

### **COOL:**

A bluish white. Using this mode when watching bright pictures allows you to enjoy a more vivid and bright picture.

### **NORMAL:**

The normal white colour.

### **WARM:**

A reddish white. Using this mode when watching films allows you to enjoy colours that are characteristic of films.

## FEATURES

Choose **FEATURES** and press the **OK** or ► button to display the sub-menu.

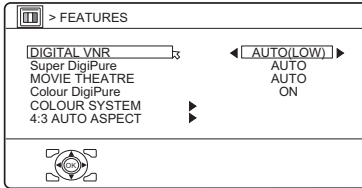

### ■ DIGITAL VNR

The DIGITAL VNR function cuts down the amount of ‘noise’ (‘snow’ or interference) in the original picture.

You can choose from the three DIGITAL VNR function settings of AUTO, MIN and MAX.

#### **AUTO(LOW)/AUTO(HIGH):**

The TV will automatically adjust the level of the DIGITAL VNR effect to match the amount of noise in the picture, giving you the best possible picture.

- If you set the DIGITAL VNR effect too high it can make the picture less sharp. It is recommended you use the AUTO(LOW) setting if you can. If you set the DIGITAL VNR function to AUTO(LOW) but still notice some noise, change the setting from AUTO(LOW) to AUTO(HIGH).

#### **MIN:**

The level of the DIGITAL VNR effect is set to the minimum. If you set the DIGITAL VNR function to AUTO(LOW) but feel that the sharpness of the original picture has not been reproduced fully, change the setting from AUTO(LOW) to MIN.

- The MIN setting is not suitable for low-quality pictures which contain a lot of noise.

#### **MAX:**

The level of the DIGITAL VNR effect is set to the maximum. If you set the DIGITAL VNR function to AUTO(HIGH) but still notice some noise, change the setting from AUTO(HIGH) to MAX.

- The MAX setting is not suitable for high-quality pictures which contain very little noise.

### ■ Super DigiPure

The Super DigiPure function uses the latest in digital technology to give you a natural-looking picture. The Super DigiPure function includes the following two functions.

#### **DigiPure function:**

This function helps to create a natural-looking picture by eliminating unnecessary edges from high-contrast and crisp images. For images with low-contrast, edges are added to produce a sharper, more detailed picture.

You can choose from the three DigiPure function settings of AUTO, MIN and MAX.

- If you set the DigiPure effect too high on a low-quality picture that contains a lot of noise, this may actually make the noise worse. We recommend you use the AUTO setting if you can.

#### **Picture motion compensation function:**

This function displays fast-moving pictures (for example, the players or ball in a football game) more smoothly and naturally on the screen.

- The effect level of the picture motion compensation function cannot be changed. The effect level is the same no matter which of the AUTO, MIN or MAX settings is used.

#### **AUTO:**

The TV will automatically adjust the level of the DigiPure effect to match the amount of noise in the picture, giving the best possible picture.

**MIN:**

The level of DigiPure effect is set to the minimum. When you set the Super DigiPure function to AUTO and notice some noise, change the setting from AUTO to MIN.

- The MIN setting is not suitable for high-quality pictures which contain very little noise.

**MAX:**

The level of DigiPure effect is set to the maximum. If you set the Super DigiPure function to AUTO but feel that the original picture quality has not been reproduced fully, change the setting from AUTO to MAX.

- The MAX setting is not suitable for low-quality pictures which contain a lot of noise.

**OFF:**

The Super DigiPure function is turned off.

■ **MOVIE THEATRE**

The MOVIE THEATRE function displays a cinema film picture more smoothly and naturally on the screen.

**AUTO:**

The television automatically recognizes the type of signal and turns the function on and off.

**ON:**

This function is turned on.

**OFF:**

This function is turned off.

- The motion may appear unnatural when viewing images with the NTSC colour system. When the MOVIE THEATRE function is set to AUTO or ON, the motion may appear unnatural when viewing images with the NTSC colour system.

■ **Colour DigiPure**

Makes the colour outline stand out and increases the sharpness giving a clearer picture.

**ON:**

Colour DigiPure works. Normally use with this function turned on.

**OFF:**

Colour DigiPure doesn't work. This gives a less clear picture than when this function is turned on.

■ **COLOUR SYSTEM**

The colour system is chosen automatically. However, if the picture is not clear or no colour appears, choose the colour system manually.

**1 Choose COLOUR SYSTEM. Then press the OK or ► button**

The sub-menu of the COLOUR SYSTEM function appears.

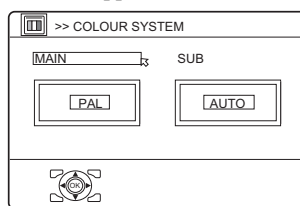

**2 Press the ◀/▶ buttons to choose MAIN or SUB**

**MAIN:**

You can change the colour system of the main-picture.

**SUB:**

You can change the colour system of the sub-picture.

- Choose MAIN when a sub-picture is not displayed.

**3 Press the ▼/▲ buttons to choose the appropriate colour system. Then press the OK button**

**PAL:**

PAL system

**SECAM:**

SECAM system

**NTSC 3.58:**

NTSC 3.58 MHz system

**NTSC 4.43:**

NTSC 4.43 MHz system

**AUTO:**

This function detects a colour system from the input signal. You can only use this when you are viewing a picture from programme number PR 0 (AV), or an EXT terminal.

- The AUTO function may not function properly if you have poor signal quality. If the picture is abnormal in the AUTO function, choose another colour system manually.
- When in the Programme numbers PR 0 (AV) to PR 99, you cannot choose NTSC 3.58 or NTSC 4.43. SECAM cannot be chosen when the COUNTRY setting is UNITED KINGDOM.
- “COLOUR SYSTEM” cannot be chosen when you are watching the EXT-4 picture.

## ■ 4:3 AUTO ASPECT

You can choose one of three ZOOM modes, REGULAR, PANORAMIC or 14:9 ZOOM, as the ZOOM mode for the normal picture (4:3 aspect ratio).

### 1 Choose 4:3 AUTO ASPECT then press the **OK** button

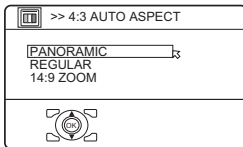

D0017-EN

### 2 Press the **▼/▲** buttons to choose a ZOOM mode

# SOUND menu

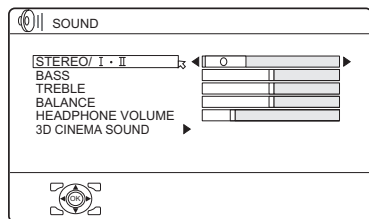

D0019-EN

- Functions in the “SOUND” menu other than “HEADPHONE VOLUME” work for the TV speakers. They do not work for the sound from the headphones.
- When the headphones are connected and only one screen is displayed, only “HEADPHONE VOLUME” can be used.

## STEREO / I • II

When you are viewing a bilingual broadcast programme, you can choose the sound from Bilingual I (Sub I) or Bilingual II (Sub II). If you have poor reception on a stereo broadcast, you can change from stereo to mono sound so that you can hear the broadcast more clearly and easily.

∞ : Stereo sound

○ : mono sound

I : Bilingual I (sub I)

II : Bilingual II (sub II)

- The sound mode you can choose differs depending on the TV programme.
- This function does not work in the EXT modes.

## BASS

You can adjust the low tone of the sound.

- ◀ : weaker
- ▶ : strong

## TREBLE

You can adjust the high tone of the sound.

- ◀ : weaker
- ▶ : strong

## BALANCE

You can adjust the volume balance between the left and right speaker.

- ◀ : turn the left speaker’s volume level up.
- ▶ : turn the right speaker’s volume level up.

## HEADPHONE VOLUME

Adjust the volume of the sub-picture sound which is heard through the headphones when set to 2-pictures multi.

- ◀ : Reduce volume
- ▶ : Increase volume

- When not set to 2-pictures multi, the headphone volume is adjusted with the  $\triangleleft$  /  $\triangleright$  (volume) buttons.

## 3D CINEMA SOUND

Press the **3D** button to set the 3D CINEMA SOUND effect when 3D CINEMA SOUND is set to ON or MONO.

**Choose 3D CINEMA SOUND. Then press the OK or ▶ button to display the sub-menu.**

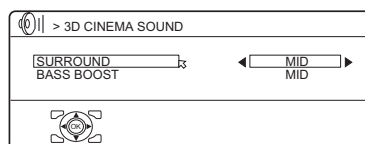

D0111-EN

### ■ SURROUND

Adjust the surround effect.

You can choose HIGH, MID or LOW.

Choosing LOW will reduce the surround effect and choosing HIGH will increase the surround effect.

### ■ BASS BOOST

Adjust the bass sound.

You can choose HIGH, MID or LOW.

Choosing LOW will reduce the bass sound and choosing HIGH will increase the bass sound.

# FEATURES menu

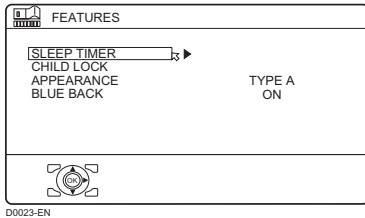

## SLEEP TIMER

You can set the TV to automatically turn off after a set period of time.

### 1 Choose SLEEP TIMER. Then press the OK or ► button

A Sub-menu of the SLEEP TIMER function appears.

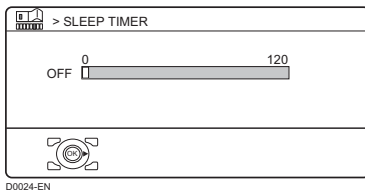

### 2 Press the ◀/▶ buttons to set the period of time. Then press the OK button

You can set the period of time for up to 120 minutes (2 hours) in 10 minute steps.

- One minute before the SLEEP TIMER function turns off the TV, “GOOD NIGHT!” appears.
- The SLEEP TIMER function cannot be used to turn off the TV’s main power.
- When the SLEEP TIMER function is on, you can display the sub-menu of the SLEEP TIMER function again to confirm or change the remaining period of time of the SLEEP TIMER function. Press the OK button to leave the menu after confirming or changing the remaining time.

### To cancel the SLEEP TIMER function:

Press the ◀ button to set the period of time to “OFF”.

## CHILD LOCK

When there is a TV channel you do not want your children to watch, you can use the CHILD LOCK function to lock out the TV channel. Even when a child chooses a programme number (PR) for a locked TV channel the screen will change to blue and display  (CHILD LOCK) so the TV channel cannot be viewed. Unless you enter a pre-set ID number by a special operation, the lock cannot be released and the child cannot view the TV channel.

### ■ To set the CHILD LOCK function

#### 1 Choose CHILD LOCK, then press the 0 button

“SET ID NO.” (ID number setting screen) appears.

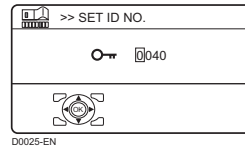

#### 2 Set the ID number to your liking

#### 1 Press the ▼/▲ buttons to choose a number.

#### 2 Press the ◀/▶ buttons to move the cursor.

#### 3 Press the OK button

The Sub-menu of CHILD LOCK appears.

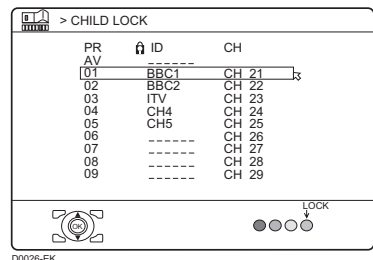

**4 Press the ▼/▲ buttons to choose a TV channel**

Every time you press the ▼/▲ buttons, the Programme number (PR) changes, and the picture of the TV channel registered in the Programme number (PR) is displayed on the screen.

**5 Press the blue button and set the CHILD LOCK function. Then press the OK button**

🔒 (CHILD LOCK) appears and the TV channel is locked.

**To reset the CHILD LOCK function:**

Press the blue button again.

🔒 (CHILD LOCK) disappears.

To disable easy resetting of the CHILD LOCK function, the menu disappears if you choose the CHILD LOCK function and press the **OK** button.

**■ To view a locked TV channel**

**1 Choose a programme number (PR) of a locked TV channel with the number buttons or PR LIST**

The screen changes to blue and the 🔒 (CHILD LOCK) appears. You cannot view the TV channel.

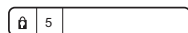

D0027-EN

**2 Press the ⓘ (Information) button to display “ID NO.” (ID No. input screen)**

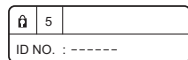

D0028-EN

**3 Press the number buttons to enter the ID number**

The lock is temporarily released so you can view the TV channel.

**If you have forgotten the ID number:**

Perform step 1 of “To set the CHILD LOCK function”. After confirming the ID number, press the **TV** button to exit the menu.

- Even if you reset the lock temporarily, it does not mean that the CHILD LOCK function set for the TV channel is cancelled. The next time anyone tries to view the TV channel, it will be locked again.
- When you want to cancel the CHILD LOCK function, you must perform the operation “To set the CHILD LOCK function” again.
- To stop it being easy to choose the programme number (PR) of a locked TV channel, the programme number (PR) has been set so that it cannot be chosen with the ▼/▲ buttons or the buttons of the TV.
- To stop it being easy to reset the lock, “ID NO.” (ID No. input screen) is set so that it cannot appear unless you press the ⓘ (Information) button.

**APPEARANCE**

Press the ◀/▶ button and choose the format in which the channel number is displayed from the three types: TYPE A, TYPE B and TYPE C.

**BLUE BACK**

You can set the TV to automatically change to a blue screen and mute the sound if the signal is weak or absent, or when there is no input from an external device.

**ON:**

This function is turned on.

**OFF:**

This function is turned off.



# SET UP menu

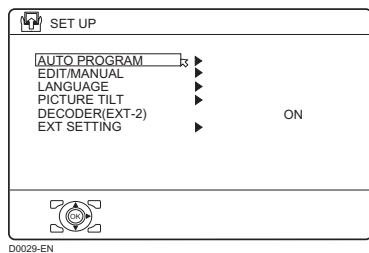

## AUTO PROGRAM

You can again perform the AUTO PROGRAM function TV channel automatic registration which was performed in the “Initial settings” (page 8).

To receive SKY 1 you need a satellite tuner. You must have the satellite tuner set to SKY 1 before starting the AUTO PROGRAM function.

### 1 Choose AUTO PROGRAM, then press the OK or ► button

The COUNTRY menu appears as a sub-menu of the AUTO PROGRAM function. There are two COUNTRY menus. Pressing the yellow button changes the COUNTRY menu as follows:

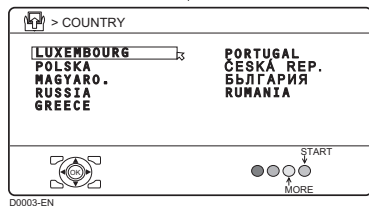
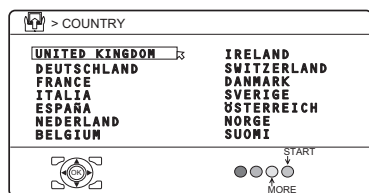

### 2 Press the ◀/▶ and ▼/▲ buttons to choose the country where you are

### 3 Perform steps 5 and 6 of the “Initial settings” (page 9)

## EDIT/MANUAL

The EDIT/MANUAL functions are divided into two types:

- editing the current programme numbers (PR) (EDIT functions); and
- manually storing a TV channel you want to view on a particular programme number (PR) (MANUAL function).

Here are the details about these functions:

### MOVE:

This function changes the programme number (PR) of a TV channel.

### ID:

This function registers a channel name (ID) to a TV channel.

### INSERT:

This function adds a new TV channel in the current programme numbers (PR) list by using the CH number.

- You cannot use the INSERT function if you do not know the channel number of a TV channel. Use the MANUAL function to register a TV channel in the programme number (PR).

### DELETE:

This function deletes a TV channel you do not want to list.

### MANUAL:

This function manually stores a new TV channel in a programme number (PR).

## Caution

- Using the MOVE, DELETE or INSERT functions rewrites the current programme numbers (PR) list. Therefore, the programme numbers (PR) of some of the TV channels will change.
- Using the MANUAL function for a TV channel for which the CHILD LOCK function has been set cancels the CHILD LOCK function for that channel.
- Using the MANUAL function for a TV channel for which the DECODER (EXT-2) function has been set to ON returns the setting of the DECODER (EXT-2) function for that channel to OFF.
- When a TV channel has already been registered in PR 99, using the INSERT function deletes that TV channel.

■ **Basic operation**

**1 Choose EDIT/MANUAL, then press the OK or ► button**

The EDIT menu appears.

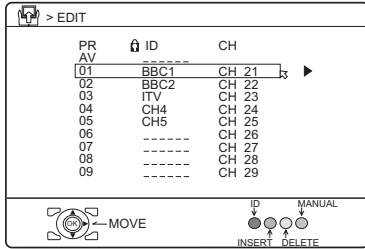

D0038-EK

**2 Follow the description for the function you want to use**

**3 Press the OK button to complete the settings**

The T-V LINK menu appears.

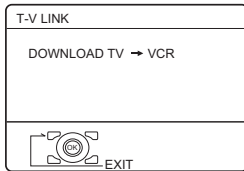

D0005-EN

**If you do not have a T-V LINK compatible VCR connected:**

Press the **TV** button to exit the T-V LINK menu.

The T-V LINK menu disappears.

**If you have a T-V LINK compatible VCR connected to the EXT-2 terminal:**

Follow “Downloading the data to VCR” on page 11 to transmit the programme number (PR) data.

- For programme number PR 0, “AV” appears in the programme numbers (PR) list.
- An EXT terminal number does not appear in the programme numbers (PR) list.

- The CH/CC number is a number unique to the TV and corresponds to the channel number of a TV channel. For the relationship between a channel number and a CH/CC number, see “CH/CC NUMBER” on page 37.

■ **MOVE**

**1 Press the ▼/▲ buttons to choose a TV channel**

Every time you press the ▼/▲ buttons, the programme number (PR) changes and the picture of the TV channel stored in the programme number (PR) appears on the screen.

**2 Press the ► button to start the MOVE function**

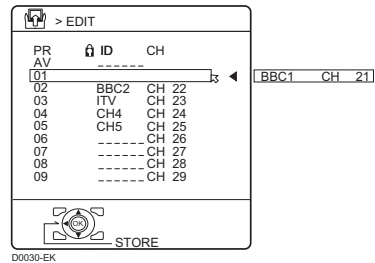

D0030-EK

**3 Press the ▼/▲ buttons to choose a new programme number (PR)**

**To cancel the MOVE function:**  
Press the **BACK** button.

**4 Press the ◀ button to change the programme number (PR) of a TV channel to a new programme number (PR)**

## ■ DELETE

### 1 Press the ▼/▲ buttons to choose a TV channel

Every time you press the ▼/▲ buttons, the programme number (PR) changes and the picture of the TV channel stored in the programme number (PR) appears on the screen.

### 2 Press the yellow button to delete the TV channel

The TV channel is deleted from the programme numbers (PR) list.

## ■ ID

### 1 Press the ▼/▲ buttons to choose a TV channel

Every time you press the ▼/▲ buttons, the programme number (PR) changes and the picture of the TV channel stored in the programme number (PR) appears on the screen.

### 2 Press the red button to start the ID function

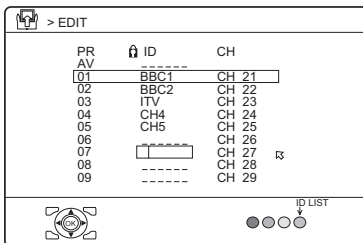

D0031-EK

### 3 Press the ▼/▲ buttons to choose the first character of a channel name (ID) you want to give the TV channel

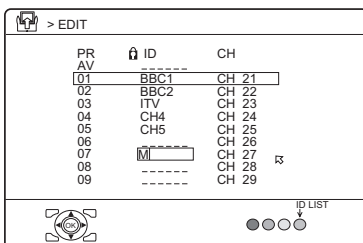

D0032-EK

### 4 Press the blue button to display the ID LIST (channel name list)

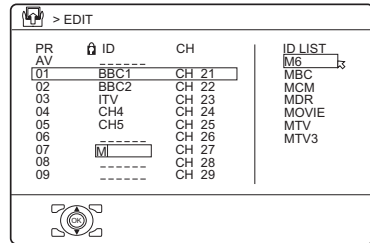

D0033-EK

### 5 Press the ▼/▲ buttons to choose the channel name (ID)

#### To cancel the ID function:

Press the **BACK** button.

### 6 Press the OK button to give a channel name (ID) to a TV channel

- You can give your own unique channel name (ID) to the TV channel. When you have finished step 3, do not go to step 4. Press the ◀/▶ buttons to move the cursor, and press the ▼/▲ buttons to choose each character of the channel name (ID). Then press the **OK** button to register the channel name (ID) to the TV channel.

### Before performing INSERT or MANUAL operation

- If you register the TV channel (SECAM-L system) from a French station, be sure to set the **COUNTRY** setting to **FRANCE**. If the **COUNTRY** setting is not set to **FRANCE**, perform steps 1 and 2 of the “**AUTO PROGRAM**” (page 33) procedure and set the **COUNTRY** setting to **FRANCE** before pressing the **OK** button.
- A **CH/CC** number unique to this TV and corresponding to the Channel number of a TV channel is required. Find the corresponding **CH/CC** number from a table “**CH/CC NUMBER**” on page 37 based on the Channel number of the TV channel.

- When the COUNTRY setting is not FRANCE, use a two-digit CH/CC number. When the COUNTRY setting is FRANCE, use a three-digit CH/CC number.

■ **INSERT**

- Press the ▼/▲ buttons to choose a programme number (PR) for which you will register a new TV channel
- Press the green button and start the INSERT function

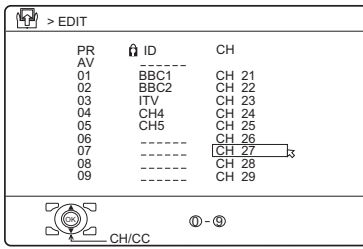

**To cancel the INSERT function:**  
Press the **BACK** button.

- When the COUNTRY setting is UNITED KINGDOM:  
Press the number buttons to enter the remaining CH number
  - You cannot enter CC numbers.
- When the COUNTRY setting is IRELAND:  
Press the ▼/▲ buttons to choose “CH” or “CC”, then enter the remaining CH or CC number

The TV shifts to registration mode. When the registration is completed, the picture of the TV channel appears on the screen.

- The CH/CC number is a number given to each broadcast frequency that carries a TV channel. If the TV cannot detect the TV channel corresponding to the broadcast frequency indicated by the CH/CC number, a “no-signal” picture appears.

■ **MANUAL**

- Press the ▼/▲ buttons to choose a programme number (PR) for a new TV channel
- Press the blue button to activate the MANUAL function

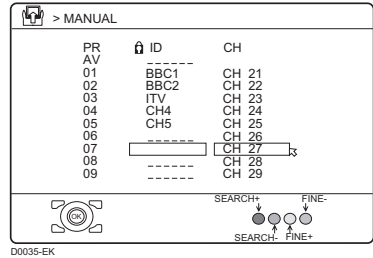

**To cancel the MANUAL function:**  
Press the **BACK** button.

**When the COUNTRY setting is IRELAND:**  
At the right side following the CH/CC number, the SYSTEM (broadcasting system) of the TV channel appears.

- When the COUNTRY setting is UNITED KINGDOM:  
Continue to step 4
- When the COUNTRY setting is IRELAND:  
Press the ► button to choose the SYSTEM (broadcasting system) for a TV channel you want to register  
If you do not know the correct broadcasting system, set the SYSTEM to “I”. If “I” is not correct, you will not hear the sound normally when the TV detects a TV channel. In this case, retry to set the SYSTEM correctly so that no problem arises.

- Press the green or red button to search for a TV channel  
Scanning stops when the TV finds a TV channel. Then the TV channel is displayed.

## 5 Press the green or red button repeatedly until the TV channel you want appears

**If the TV channel reception is poor:**  
Press the blue or yellow button to fine-tune the TV channel.

## 6 Press the OK button and register the TV channel to a Programme number (PR)

The normal EDIT menu is resumed.

### ■ CH/CC NUMBER

- When you want to use the INSERT function on page 36, find the CH/CC number corresponding to the channel number of the TV channel from this table. If you want to know a particular TV channel's channel menu, look in TV listings magazines or contact the broadcaster.
- When the COUNTRY setting is UNITED KINGDOM, the CC number channels and the channels from CH/CC 02 to CH/CC 12 cannot be received.

CH	Channel
CH 02	E2, IR A
CH 03	E3, IR B
CH 04	E4, IR C
CH 05	E5, IR D
CH 06	E6, IR E
CH 07	E7, IR F
CH 08	E8, IR G
CH 09	E9
CH 10	E10, IR H
CH 11	E11, IR J
CH 12	E12
CH 21	E21
CH 22	E22
CH 23	E23
CH 24	E24
CH 25	E25
CH 26	E26
CH 27	E27
CH 28	E28
CH 29	E29
CH 30	E30
CH 31	E31
CH 32	E32
CH 33	E33
CH 34	E34
CH 35	E35
CH 36	E36
CH 37	E37
CH 38	E38
CH 39	E39

CC	Channel
CC 01	S1
CC 02	S2
CC 03	S3
CC 04	S4
CC 05	S5
CC 06	S6
CC 07	S7
CC 08	S8
CC 09	S9
CC 10	S10
CC 11	S11
CC 12	S12
CC 13	S13
CC 14	S14
CC 15	S15
CC 16	S16
CC 17	S17
CC 18	S18
CC 19	S19
CC 20	S20
CC 21	S21
CC 22	S22
CC 23	S23
CC 24	S24
CC 25	S25
CC 26	S26
CC 27	S27
CC 28	S28
CC 29	S29
CC 30	S30

CH	Channel
CH 40	E40
CH 41	E41
CH 42	E42
CH 43	E43
CH 44	E44
CH 45	E45
CH 46	E46
CH 47	E47
CH 48	E48
CH 49	E49
CH 50	E50
CH 51	E51
CH 52	E52
CH 53	E53
CH 54	E54
CH 55	E55
CH 56	E56
CH 57	E57
CH 58	E58
CH 59	E59
CH 60	E60
CH 61	E61
CH 62	E62
CH 63	E63
CH 64	E64
CH 65	E65
CH 66	E66
CH 67	E67
CH 68	E68
CH 69	E69

CC	Channel
CC 31	S31
CC 32	S32
CC 33	S33
CC 34	S34
CC 35	S35
CC 36	S36
CC 37	S37
CC 38	S38
CC 39	S39
CC 40	S40
CC 41	S41
CC 75	X
CC 76	Y
CC 77	Z
CC 78	Z+1
CC 79	Z+2

## LANGUAGE

The LANGUAGE setting which was performed in the “Initial settings” (page 8) can be changed.

### 1 Choose LANGUAGE, then press the OK or ► button

A sub-menu of the LANGUAGE function appears.

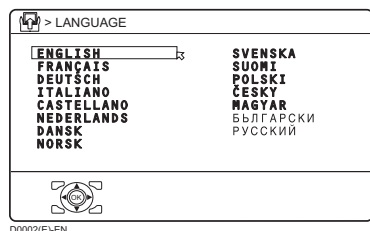

### 2 Press the ◀/▶ and ▼/▲ buttons to choose a language. Then press the OK button

## PICTURE TILT

There are cases where the Earth’s magnetic field may make the picture tilt or make unnatural colours appear in the corner of the screen. If this happens, you can correct it.

### 1 Choose PICTURE TILT, then press the OK or ► button

The sub-menu of the PICTURE TILT function appears.

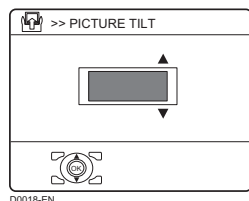

### 2 Press the ▼/▲ buttons until the picture becomes level. Then press the OK button

## DECODER (EXT-2)

If you have a decoder connected to a T-V LINK compatible VCR, which in turn is connected to the EXT-2 terminal, use the DECODER (EXT-2) function to unscramble the scrambled TV channels.

### 1 Turn on the decoder power

### 2 Display the scrambled TV channel on the TV

Even if the decoder is working, a scrambled picture appears.

### 3 Display the SET UP menu and choose DECODER (EXT-2)

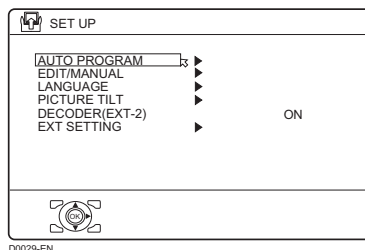

### 4 Press the ◀/▶ buttons to choose ON

An unscrambled picture appears.

### To cancel the DECODER (EXT-2) function:

Press the ◀/▶ buttons to choose OFF.

### 5 Press the OK button to complete the setting

The T-V LINK menu appears.

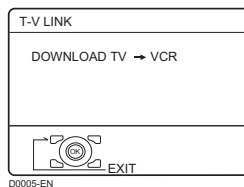

You can send the programme numbers data to a VCR with the T-V LINK function.

## 6 Turn on the VCR, and then press the **OK** button to transmit the data to VCR

The T-V LINK menu disappears once the data transmission ends.

## 7 If you have another TV channel capable of being unscrambled with a Decoder, repeat steps 2 to 6

If the DECODER (EXT-2) function has been set to “ON” but the TV channel cannot be unscrambled, check the following:

- Has the decoder been connected to the VCR properly according to the VCR and decoder instruction manuals?
- Has the decoder power been turned on?
- Can the TV channel be unscrambled with a decoder?
- Do you need to change the VCR settings in order to connect the decoder? Confirm that the VCR is set properly by rechecking the VCR instruction manual.

## EXT SETTING

### 1 Choose **EXT SETTING**, then press the **OK** or **▶** button

The EXT SETTING menu appears.

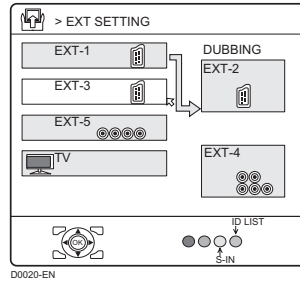

### 2 Follow the instructions for the function you want to use and operate the function

#### **S-IN:**

You can enjoy the high-quality picture of the 2 S-VIDEO signal (Y/C signal).

#### **ID LIST:**

You can have a name for each of the devices connected for each EXT terminal.

#### **DUBBING:**

You can choose a signal source to be output from an EXT-2 terminal.

### ■ **S-IN (S-VIDEO input)**

You can connect a device (such as an S-VHS VCR) to enjoy the high-quality picture of the S-VIDEO signal (Y/C signal).

#### **Preparation:**

- First read the device’s instruction manual and “Additional preparation” on page 42 to connect the device to the TV properly. Second, follow the device’s instruction manual to set the device so that it sends an S-VIDEO signal (Y/C signal) to the TV.
- Do not set S-IN (S-VIDEO input) to an EXT terminal connected to a device which cannot output an S-VIDEO (Y/C signal). If it is set wrongly, a picture cannot appear.

**1 Press the ◀/▶ or ▼/▲ buttons to choose an EXT terminal**

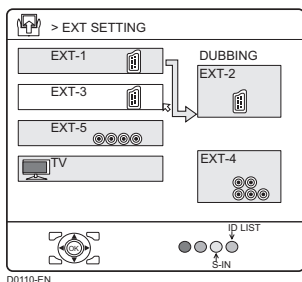

D0110-EN

**2 Press the yellow button and set the S-IN (S-VIDEO input). Then press the OK button**

An S-IN (S-VIDEO input) mark is displayed. You can view an S-VIDEO signal (Y/C signal) instead of the regular video signal (composite signal).

**To cancel the S-IN (S-VIDEO input) setting:**

Press the yellow button and turn off S-IN (S-VIDEO input) mark. The regular video signal (composite signal) pictures are resumed.

- The EXT-1 terminal does not support S-VIDEO signal (Y/C signal) and you cannot set S-IN (S-VIDEO input) in the EXT-1 terminal.
- Setting S-IN (S-VIDEO input) changes the head character from “E” to “S”. When an EXT terminal receives a normal video signal, “E1”, “E2”, “E3” or “E4” appears on the display. This changes to “S2”, “S3” or “S5” when it receives an S-VIDEO signal.
- Even a device which can output an S-VIDEO signal (Y/C signal) may output a regular video signal (composite signal) depending on the device setting. If a picture cannot appear because the S-IN (S-VIDEO input) setting has been made, read the device instruction manual carefully again to check for the device settings.

**■ ID LIST**

You can store a name for each of the devices connected to each EXT terminal. Giving a name to an EXT terminal makes the EXT terminal number appear on the screen, together with its name.

**1 Press the ◀/▶ or ▼/▲ buttons to choose an EXT terminal**

**2 Press the blue button to display the name list (ID LIST)**

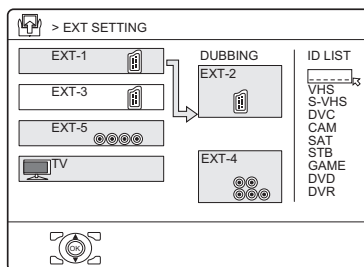

D0021-EN

**3 Press the ▼/▲ buttons to choose a name. Then press the OK button**

The ID LIST disappears and the name is assigned to the EXT terminal.

- You cannot assign an EXT terminal name not found in the name list (ID LIST).

**To erase a name assigned to the EXT terminal:**

Choose a blank space.

**4 Press the OK button to complete the setting**



## ■ DUBBING

You can choose a signal source to be output from the EXT-2 terminal.

You can do this with the output signals of the devices connected to other EXT terminals, or with the picture and sound from a TV channel you are currently viewing.

### 1 Press the ◀/▶ buttons to choose the arrow from the menu

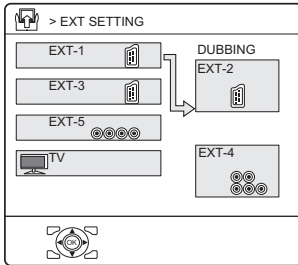

D0022-EN

### 2 Press the ▼/▲ buttons to choose an EXT terminal or TV. Then press the OK button

The arrow in the menu represents a signal flow. The left side of the arrow shows a signal source output from the EXT-2 terminal.

#### EXT-1/EXT-3/EXT-5:

The output signal of the device connected to an EXT terminal passes through the TV and is output from the EXT-2 terminal.

#### TV:

The picture and sound of the TV channel you are currently viewing are output from the EXT-2 terminal.

- During dubbing, you cannot turn off the TV. Turning off the TV also turns off the output from the EXT-2 terminal.
- When you choose an EXT terminal as an output, you can view a TV programme or a picture from the other EXT terminal while dubbing the picture from a device connected to the EXT terminal onto a VCR connected to the EXT-2 terminal.
- The RGB signals from TV games cannot be output. Teletext programmes cannot be output.

# Additional preparation

## Connecting external equipment

Connect the equipment to the TV, making the correct rear panel and front panel connections.

### Before connecting anything:

- Read the manuals that came with the equipment.  
Depending on the equipment, the connection method may be different from the diagram. Also, the equipment settings may need to change depending on the connection method.
- Turn off all the equipment including the TV.
- The “Specifications” on the back cover give the details of the EXT terminals. If you are connecting equipment not listed in the following connection diagram, see the table to choose the best EXT terminal.
- Connecting cables are not supplied.

- ① VCR (composite signal)
- ② VCR (composite signal/S-VIDEO signal)
- ③ T-V LINK compatible VCR (composite signal/S-VIDEO signal)
- ④ Decoder
- ⑤ DVD player (composite signal/S-VIDEO signal)
- ⑥ DVD player (composite signal/RGB signal)
- ⑦ DVD player (component video signals; Pr/Pb/Y)
- ⑧ TV game (composite signal/RGB signal)
- ⑨ TV game (composite signal/S-VIDEO signal)
- ⑩ Headphones
- ⑪ Camcorder (composite signal/S-VIDEO signal)
- ⑫ SCART cable
- ⑬ Audio cable
- ⑭ Video cable
- ⑮ S-VIDEO cable
- ⑯ Component cable

### HV-36P38SJE

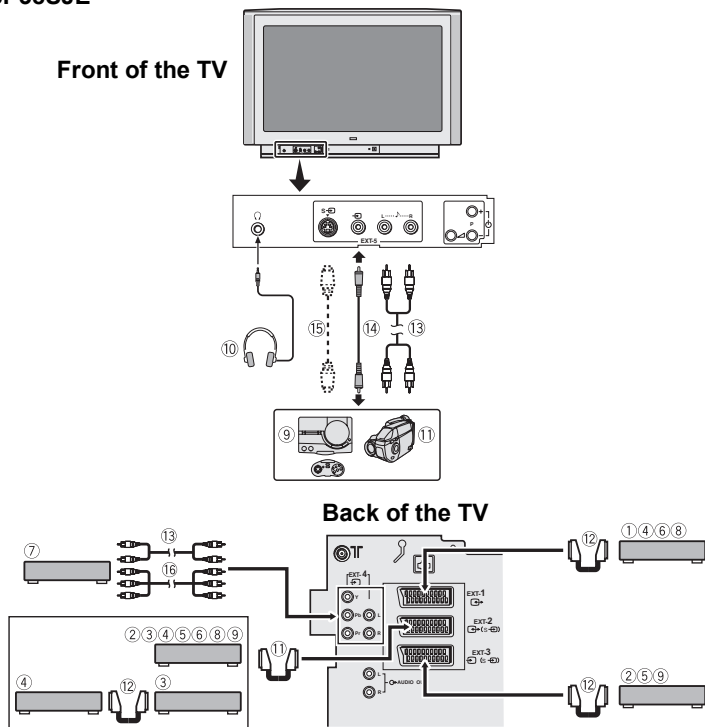

HV-32P37SJE/HV-28P37SJE

Back of the TV

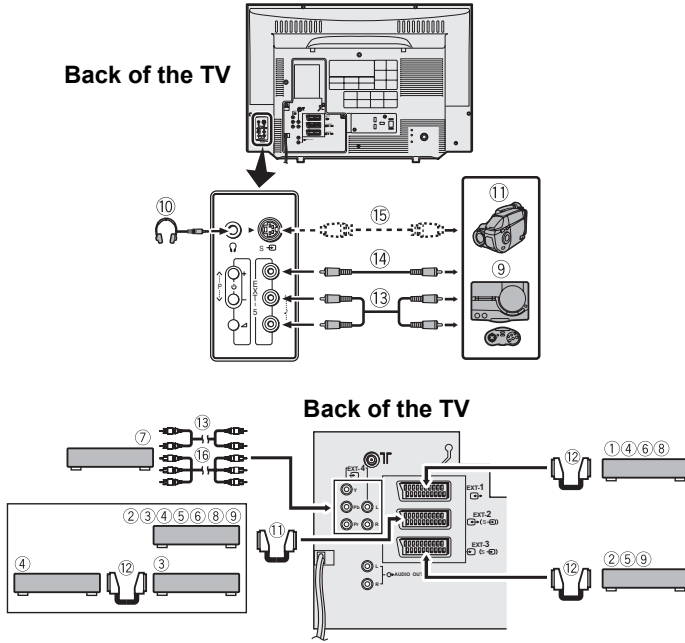

■ **Equipment which can output the S-VIDEO signal (Y/C signal) such as an S-VHS VCR**

Connect the equipment to an EXT terminal (but not the EXT-1 terminal).

You can choose between an S-VIDEO signal (Y/C signal) and a regular video signal (composite signal). For details of how to operate the equipment, see “S-IN (S-VIDEO input)” on page 39.

■ **T-V LINK compatible VCR**

Be sure to connect the T-V LINK compatible VCR to the EXT-2 terminal. If not, the T-V LINK function will not work properly.

- When connecting a T-V LINK compatible VCR to the EXT-2 terminal, be sure to connect the decoder to the VCR. If not, the T-V LINK function may not work properly. After you have stored TV channels in the programme numbers (PR) list, set the DECODER (EXT-2) function for the programme number (PR) to ON to unscramble a scrambled TV channel. For details, see “EXT SETTING” on page 39.

■ **Connecting headphones**

Connect the headphones with a stereo mini-jack (3.5 mm diameter) to the headphone socket at the TV rear panel.

- No sound comes from the TV speakers when the headphones are connected and only one screen is displayed.

■ **Video or sound signal output from the EXT-2 terminal**

You can change over the output of the video/sound signal from the EXT-2 terminal. This is useful when you want to dub the video/sound from another device onto the VCR connected to the EXT-2 terminal. For details on how to do this, see “DUBBING” on page 41.

■ **TV output from the EXT-1 terminal**

The video/sound signal of a TV channel you are viewing is always output from the EXT-1 terminal.

- Changing over a programme number (PR) also changes over the TV output from the EXT-1 terminal.
- The video/sound signal from an EXT terminal cannot be output.
- Teletext programmes cannot be output.

■ **Connecting speakers/amplifier**

While referring to the audio equipment connection diagram, connect the audio equipment you want to the TV. You can use external front speakers to listen to the TV sound instead of the TV speakers.

**Before connecting anything:**

- Read the manuals provided with the amplifier and speakers.
- Turn the TV and amplifier off.
- To prevent magnetism from the speakers adversely affecting the TV screen, use magnetic-shielded speakers for the front speakers.
- Note that connecting cables are not supplied.

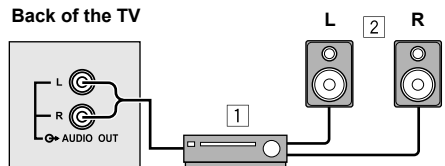

1 Amplifier  
2 Front speakers (Magnetic-shielded type)

- The output from the AUDIO OUT terminal is not interrupted by headphone connection to the TV. You cannot cut the sound from the front speaker even if you connect a headphone to the TV.
- Adjust the volume of the external speakers with the amplifier.

# Troubleshooting

---

If a problem arises while you are using the TV, please read this troubleshooting guide carefully before you ask to have the TV repaired. You may be able to fix it easily by yourself. For example, if the mains plug is disconnected from the mains outlet, or the TV aerial has problems, you may think there is a problem with the TV itself.

## Important:

- This troubleshooting guide only covers problems whose causes are not easy to decide. If you have a question when you are operating a function, read the page(s) for that function carefully, not this troubleshooting guide.
- If you follow the advice in this troubleshooting guide without any success, unplug the mains plug and ask for your TV to be repaired. Do not attempt to repair the TV by yourself or to remove the rear cover of the TV.

## ■ If you cannot turn on the TV

- Is the mains plug connected to the mains outlet?
- Is the power lamp lit? If not, press the main power button.
- Make sure you set the VCR/TV/DVD switch to the TV position. You cannot turn the TV on when the VCR/TV/DVD switch is set to the VCR or DVD position.

## ■ If you cannot turn off the TV

- Make sure you set the VCR/TV/DVD switch to the TV position. You cannot turn the TV off when the VCR/TV/DVD switch is set to the VCR or DVD position.

## ■ No picture or no sound

- Have you chosen a TV channel with very poor reception? If so, the BLUE BACK function will be activated: the entire screen becomes blue, and the sound is muted. If you still want to view the TV channel, follow the description “BLUE BACK” on page 32 to change the BLUE BACK function setting to OFF.
- If the SYSTEM setting for a TV channel is incorrect, it may prevent the sound from being issued. Follow the description “EDIT/MANUAL” on page 33 to use the MANUAL function to try to change the SYSTEM setting.

## ■ Poor picture

- If noise (snow) totally blocks out the picture, there may be a problem with the aerial or aerial cable. Check the following to try to solve the problem:

–Have the TV and aerial been connected properly?

–Has the aerial cable been damaged?

–Is the aerial pointing in the right direction?

–Is the aerial itself faulty?

- If the TV or aerial suffers interference from other equipment, stripes or noise may appear in the picture. Move any equipment such as an amplifier, personal computer, or a hair drier, that can cause interference away from your TV. Or try moving the TV. If the aerial suffers interference from a radio tower or high-voltage wire, please contact your local dealer.
- If the TV suffers interference from signals reflecting from mountains or buildings, double-pictures (ghosting) will occur. Try to change the aerial’s direction or replace it with one with better directionality.
- Are your COLOUR SYSTEM settings correct? Follow the description “COLOUR SYSTEM” on page 28 to try to solve the trouble.
- Have the COLOUR and BRIGHT settings been adjusted properly? Follow the description “BRIGHT” and “COLOUR” on page 26 to try to adjust them properly.
- Videotaping teletext is not recommended because it may not record correctly.
- When a white and bright still image (such as a white dress) is displayed on the screen, the white part may look as if it is coloured. This is unavoidable due to the nature of the picture tube itself, and not due to a TV failure. When the picture disappears from the screen, the unnatural colours will also disappear.

- When viewing images from commercially available video software products, or videos from videotapes which have been recorded improperly, the top of the image may be distorted. This is due to the condition of the video signal. There is nothing wrong with the TV.
- Since this TV is designed to make full use of the resolution of the original video source, the motion may appear unnatural when the video source is input with 625p progressive-scanning component signals. If this occurs, change the output setting of the connected device to 625i interlace-scanning component signal output. See the instructions that came with the device for more information.

### ■ Poor sound

- Have you adjusted BASS or TREBLE properly? If not, follow the description “BASS” or “TREBLE” on page 30.
- When TV channel reception is poor, it can be hard to hear stereo or bilingual sound. In this case, follow the description “STEREO / I • II” on page 30 to hear the sound more easily by changing it to a mono sound.

### ■ If the TV does not respond to the remote control

- Have the batteries of the remote control worn out? Follow the description “Putting the batteries into the remote control” on page 8 and replace them with new batteries.
- Have you attempted to use the remote control from the sides or rear of the TV or from more than seven metres away from the TV? Use the remote control in front of your TV or from less than seven metres away.
- When you are viewing a teletext programme, you cannot operate the menus. Press the **TV** button to return to the ordinary TV programme, and then try operating the menus.
- If the TV suddenly stops responding, press the main power button on the TV and turn off the main power. Press the main power button again to turn on the TV. If the TV returns to a normal state, it is not a failure.

### ■ Other issues

- When the SLEEP TIMER function operates, the TV is automatically turned off. If the TV suddenly turns off, try to press the  $\odot$ /I (standby) button to turn on the TV once again. If the TV goes back to normal, there is no problem.
- When the TV is receiving a wide-screen signal (WSS) or a signal from an external device affecting the screen size, the ZOOM mode automatically changes. When you want to resume the previous ZOOM mode, press the **ZOOM** button again.
- If you bring magnetised equipment such as a speaker near to your TV, the picture may be warped or unnatural colours may appear at the corners of the screen. In this case, keep the equipment away from your TV. If speakers cause this to happen, use magnetically-shielded speakers instead.
- A picture may be tilted due to the earth’s magnetic field. If so, use the “PICTURE TILT” on page 38 to correct the tilt.
- It takes a short period of time from the time an operation such as changing channels is performed until an image is displayed. This is not a fault. This is the time needed for the image to stabilize before it can be displayed.
- The TV may make a crackling sound due to a sudden change in temperature. The picture or sound may be normal. If you hear crackling sounds frequently while you are viewing the TV, there may be other causes. As a precaution, ask your service technician to inspect it.
- Touching the screen may cause you to feel a slight electric shock due to its static electricity. This is unavoidable due to the construction of the picture tube. It is not a problem with the TV. You can rest assured that this static discharge is not harmful.
- When set to 2-pictures multi, adjust the headphone sound with HEADPHONE VOLUME in the SOUND menu.

# Specifications

Model	HV-36P38SJE	
	When the COUNTRY setting is <b>UNITED KINGDOM</b>	When the COUNTRY setting is <b>IRELAND</b>
Broadcasting systems	CCIR I	CCIR B/G, I, D/K, L
Colour systems	PAL • The EXT terminals also support the NTSC 3.58/4.43 MHz system.	PAL, SECAM • The EXT terminals also support the NTSC 3.58/4.43 MHz system.
Channels and frequencies	E21-E69	IR A-J, E2-E12, E21-E69, S1-S41, X, Y, Z, Z+1, Z+2
Sound-multiplex systems	NICAM (I) system	NICAM (B/G, I, D/K, L) system, A2 (B/G, D/K) system
Teletext systems	FLOF (Fastext), WST (World Standard System)	FLOF (Fastext), TOP, WST (World Standard System)
Power requirements	220 - 240 V AC, 50 Hz	
Power consumption	141 W (Standby: 2.0 W)	
Picture tube size	Viewable area 86 cm (measured diagonally)	
Audio output	Rated Power output: TV: 10 W + 10 W, Woofer: 18 W	
Speakers	TV: 2 cm round × 2, (3 cm × 10 cm) oval × 4, Woofer: 16 cm round × 1	
EXT-1 terminal	Euroconnector (21-pin, SCART) • Video input, Audio L/R inputs and RGB inputs are available. • TV broadcast outputs (Video and Audio L/R) are available.	
EXT-2 terminal	Euroconnector (21-pin, SCART) • Video input, S-VIDEO (Y/C) input, Audio L/R inputs and RGB inputs are available. • Video and Audio L/R outputs are available. • T-V LINK functions are available.	
EXT-3 terminal	Euroconnector (21-pin, SCART) • Video input, S-VIDEO (Y/C) input and Audio L/R inputs are available.	
EXT-4 terminal	RCA connectors × 5 • Component video (Pr, Pb, Y) inputs (625p, 525p, 1125i) and Audio L/R inputs are available.	
EXT-5 terminal	RCA connectors × 3 S-VIDEO connector × 1 • Video input, S-VIDEO (Y/C) input and Audio L/R inputs are available.	
AUDIO OUT terminal	RCA connectors × 2 • Audio L/R outputs are available. • Output level 0.5 Vrms.	
Headphone jack	Stereo mini-jack (3.5 mm in diameter)	
Dimensions (W × H × D)	TV: 912 mm × 624 mm × 593 mm, Woofer: 435 mm × 230 mm × 120 mm	
Weight	TV: 70 kg, Woofer: 4 kg	
Accessories	Remote control unit × 1 (RM-C1800), Woofer × 1 AA/R6 dry cell battery × 2	

## We may change the design and specifications without notice.

Pictures displayed on the screen using this TV's ZOOM functions should not be shown for any commercial or demonstration purpose in public places (cafes, hotels, etc.) without the consent of the owners of copyright of the original picture sources, as this would be an infringement of copyright.

Model	HV-32P37SJE/HV-28P37SJE	
	COUNTRY setting	When the COUNTRY setting is <b>UNITED KINGDOM</b>
Broadcasting systems	CCIR I	CCIR B/G, I, D/K, L
Colour systems	PAL • The EXT terminals also support the NTSC 3.58/4.43 MHz system.	PAL, SECAM • The EXT terminals also support the NTSC 3.58/4.43 MHz system.
Channels and frequencies	E21-E69	IR A-J, E2-E12, E21-E69, S1-S41, X, Y, Z, Z+1, Z+2
Sound-multiplex systems	NICAM (I) system	NICAM (B/G, I, D/K, L) system, A2 (B/G, D/K) system
Teletext systems	FLOF (Fastext), WST (World Standard System)	FLOF (Fastext), TOP, WST (World Standard System)
Power requirements	220 - 240 V AC, 50 Hz	
Power consumption	HV-32P37SJE: 137 W (Standby: 2.0 W) HV-28P37SJE: 127 W (Standby: 2.0 W)	
Picture tube size	HV-32P37SJE: Viewable area 76 cm (measured diagonally) HV-28P37SJE: Viewable area 66 cm (measured diagonally)	
Audio output	Rated Power output: 10 W + 10 W	
Speakers	(13 cm × 6.5 cm) oval × 2	
EXT-1 terminal	Euroconnector (21-pin, SCART) • Video input, Audio L/R inputs and RGB inputs are available. • TV broadcast outputs (Video and Audio L/R) are available.	
EXT-2 terminal	Euroconnector (21-pin, SCART) • Video input, S-VIDEO (Y/C) input, Audio L/R inputs and RGB inputs are available. • Video and Audio L/R outputs are available. • T-V LINK functions are available.	
EXT-3 terminal	Euroconnector (21-pin, SCART) • Video input, S-VIDEO (Y/C) input and Audio L/R inputs are available.	
EXT-4 terminal	RCA connectors × 5 • Component video (Pr, Pb, Y) inputs (625p, 525p, 1125i) and Audio L/R inputs are available.	
EXT-5 terminal	RCA connectors × 3 S-VIDEO connector × 1 • Video input, S-VIDEO (Y/C) input and Audio L/R inputs are available.	
AUDIO OUT terminal	RCA connectors × 2 • Audio L/R outputs are available. • Output level 0.5 Vrms.	
Headphone jack	Stereo mini-jack (3.5 mm in diameter)	
Dimensions (W × H × D)	HV-32P37SJE: 948 mm × 562 mm × 550 mm HV-28P37SJE: 854 mm × 508 mm × 493 mm	
Weight	HV-32P37SJE: 54.0 kg HV-28P37SJE: 38.0 kg	
Accessories	Remote control unit × 1 (RM-C1800) AA/R6 dry cell battery × 2	

### We may change the design and specifications without notice.

Pictures displayed on the screen using this TV's ZOOM functions should not be shown for any commercial or demonstration purpose in public places (cafes, hotels, etc.) without the consent of the owners of copyright of the original picture sources, as this would be an infringement of copyright.