

Radio Cassette Player

Operating Instructions

WALKMAN

WALKMAN is a registered trademark of Sony Corporation.

WM-FX251

©1997 by Sony Corporation

Printed in Malaysia

OWNER'S RECORD

The model number is located at the front and the serial number is located inside the cassette holder. Record the serial number in the space provided below. Refer to them whenever you call upon your Sony dealer regarding this product.

Model No. WM-FX251

Serial No. _____

INFORMATION

This equipment has been tested and found to comply with the limits for a Class B digital device, pursuant to Part 15 of the FCC Rules. These limits are designed to provide reasonable protection against harmful interference in a residential installation. This equipment generates, uses, and can radiate radio frequency energy and, if not installed and used in accordance with the instructions, may cause harmful interference to radio communications. However, there is no guarantee that interference will not occur in a particular installation. If this equipment does cause harmful interference to radio or television reception, which can be determined by turning the equipment off and on, the user is encouraged to try to correct the interference by one or more of the following measures:

- Reorient or relocate the receiving antenna.
- Increase the separation between the equipment and receiver.
- Connect the equipment into an outlet on a circuit different from that to which the receiver is connected.
- Consult the dealer or an experienced radio/TV technician for help.

This device complies with Part 15 of the FCC Rules. Operation is subject to the following two conditions:

(1) This device may not cause harmful interference, and (2) this device must accept any interference received, including interference that may cause undesired operation.

You are cautioned that any changes or modifications not expressly approved in this manual could void your authority to operate this equipment.

SAFETY NOTES ON THE UNIT

WARNING

- To prevent fire or shock hazard, do not expose the unit to rain or moisture.
- Do not use headphones/earphones while driving, cycling, or operating a motorized vehicle. It may create a traffic hazard and is illegal in some areas. It can also be potentially dangerous to play your headphones/earphones at high volume while walking, especially at pedestrian crossings. You should exercise extreme caution or discontinue use in potentially hazardous situations.
- To prevent shock hazards, never open the unit while it is connected to the power source.

CAUTION

- Do not use headphones/earphones at high volume. Hearing experts advise against continuous, loud and extended play. If you experience a ringing in your ears, reduce volume or discontinue use.
- Keep the volume at a moderate level. This will allow you to hear outside sounds and to be considerate to the people around you.

SAFETY NOTES ON POWER SOURCES

To avoid battery leakage, fire, damage, explosion, etc., follow the descriptions below.

DANGER

- Do not carry dry batteries with coins or other metallic objects. It can generate heat if the positive and negative terminals of the batteries are accidentally contacted by a metallic object.

WARNING

- Use only the Sony AC-E30HG AC power adaptor (not supplied).
- To disconnect the AC power adaptor, only use the plug and not the cable.
- Do not charge a dry battery.
- Check the **+** and **-** on the batteries, and be sure to insert them like the illustration in this manual.

CAUTION

- When you are not going to use your Walkman for a long time, remove the batteries to prevent damage from battery leakage and corrosion.

Precautions

- Do not leave the unit in a location near heat sources, or in a place subject to direct sunlight, excessive dust or sand, moisture, rain, mechanical shock, or in a car with its windows closed.
- Do not wind the headphones/earphones cord around the unit. The buttons may be kept pressed, causing unnecessary battery usage.
- Do not use cassettes longer than 90 minutes except for long continuous playback.
- If the unit has not been used for a long time, set it in the playback mode to warm it up for a few minutes before inserting a cassette.
- For cleaning the case, use a soft cloth slightly moistened with mild detergent solution. Do not use alcohol, benzine or thinner.

If you have any questions or problem concerning your Walkman, please consult your nearest Sony dealer.

Specifications

- **Frequency range**
For U area indication:
FM: 87.5-108MHz (0.1MHz step)
AM: 530-1710kHz (10kHz step)
For E area indication:
FM: 87.5-108MHz (0.05MHz step)
AM: 531-1602kHz (9kHz step)
- **Power requirements**
3V DC batteries AA (R6) x 2/External DC 3V power sources
- **Dimensions**
115 x 90.5 x 34.4 mm (4 ³/₈ x 3 ³/₈ x 1 ³/₈ inches)
(w/h/d) incl. projecting parts and controls
- **Mass**
Approx. 150g (5.3 oz)
Approx. 230g (8.2 oz) incl. batteries and a tape
- **Supplied accessories**
Stereo headphones (1)/Carrying case (1)

Design and specifications are subject to change without notice.

Troubleshooting

The volume is not turned up.

- AVLS is set to LIMIT.

The sound is unstable or no audio.

- Insert two size AA (R6) batteries properly.
- Replace all batteries if they are weak.

The display shows incorrect information

- The display may show incorrect information or the preset stations may not be recalled correctly when you use the unit for the first time, or when you have left the unit without batteries for a long time. In these cases, turn the tape and radio off and then press BAND for about 10 seconds, you will hear a beep sound through the headphones and the memories of all the preset stations will be canceled. Reset these functions again.

Poor tape playback quality.

- Clean the headphones plug.
- Dirty heads. Clean them with a cotton swab slightly moistened with cleaning fluid or alcohol.

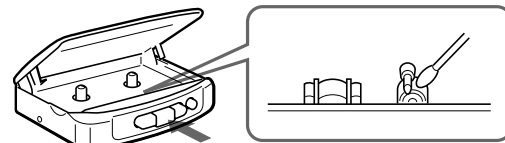

Preparations

To Insert batteries

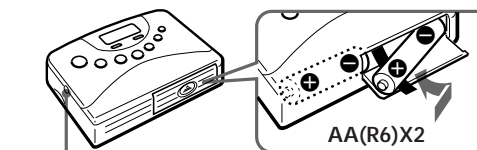

DC IN 3V

Battery life (approximate hours)

	Sony alkaline LR6 (SG)	Sony R6P (SR)
playback	22	7
radio	33	13

Notes

- When the batteries become weak, the sound will be unstable or cannot be heard. In such case, replace both batteries.
- When replacing batteries, replace both batteries within 30 minutes; otherwise all the memories will be canceled.
- The battery life may shorten depending on the operation of the unit.
- If the battery compartment lid comes off, attach it as shown.

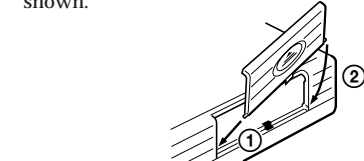

To use external power

- For house current: Connect AC-E30HG AC power adaptor (not supplied) to the DC IN 3V jack.



The polarity of the plug

To use the carrying case

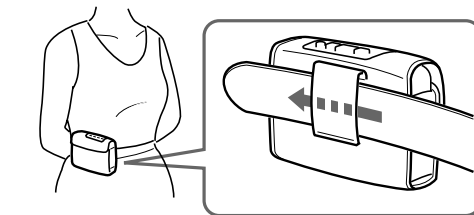

This warranty is valid only in the United States.

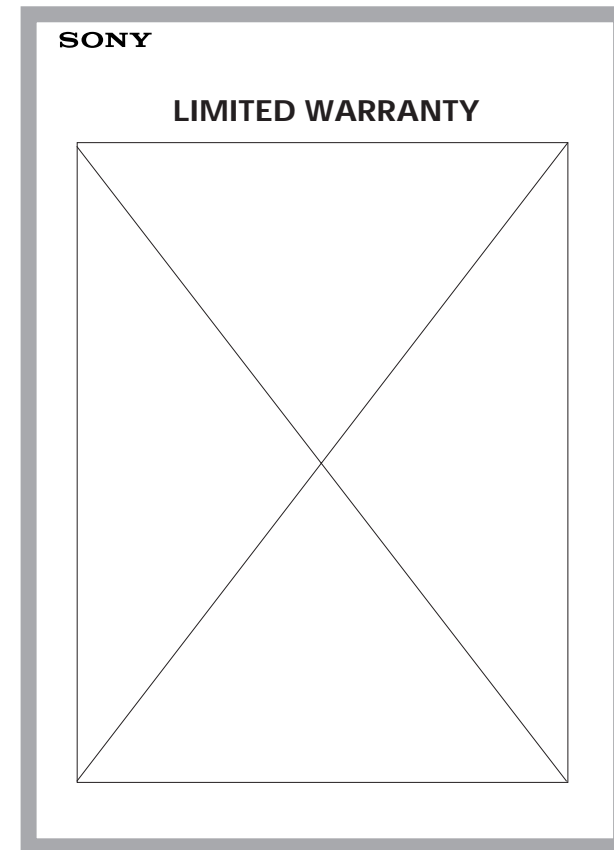

Location of parts and controls

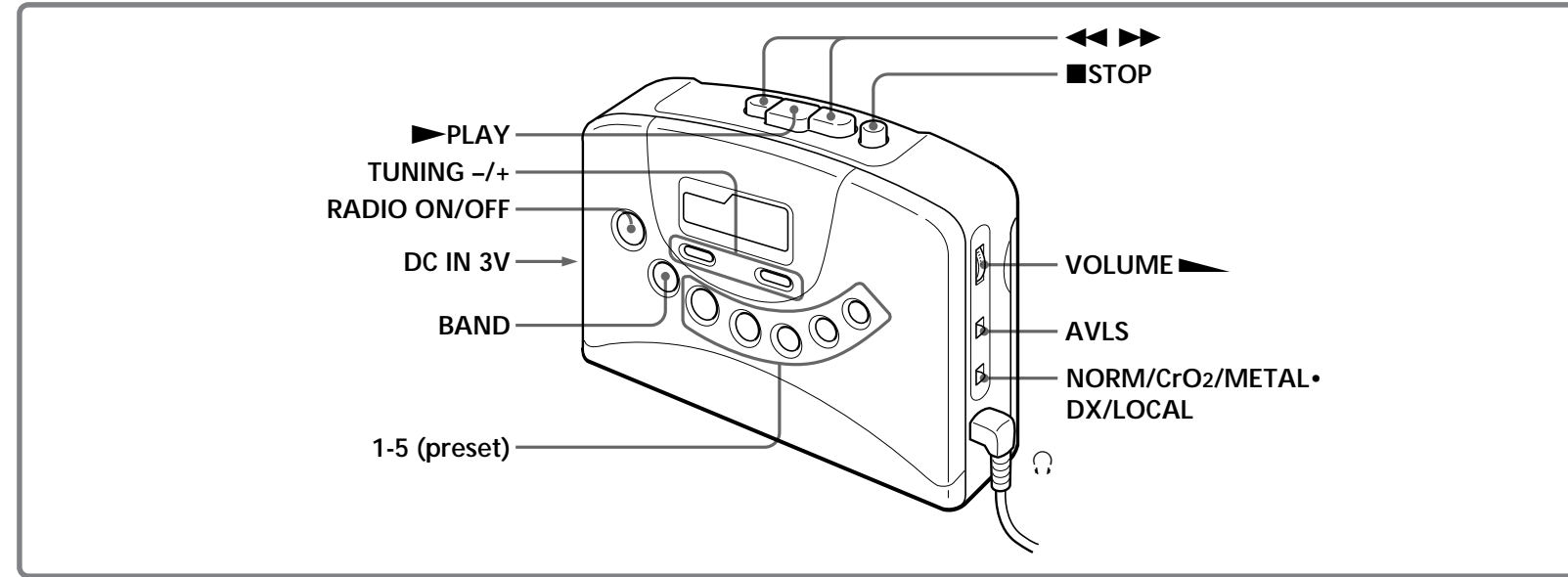

Playing a tape

- 1 Set NORM•CrO₂/METAL to match the tape type.

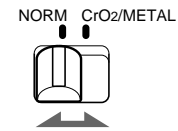

- 2 Insert a cassette and press ►PLAY.

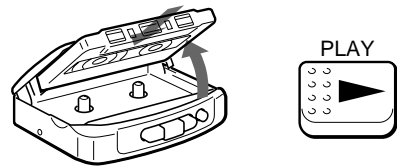

To	Press
Stop playback	■
Fast-forward or rewind the tape	▶▶ or ◀◀ (For the side facing forward)

To limit the maximum volume automatically

Set AVLS (Automatic Volume Limiter System) to LIMIT. The maximum volume is kept down to protect your ears, even if you turn the volume up. To cancel the AVLS function, set AVLS to NORM.

Note

- Do not open the cassette holder while the tape is running.

Listening to the radio

- 1 Press RADIO ON/OFF.



- 2 Press BAND to select the band (FM1, FM2, FM3 or AM).

Each time you press the button, the display changes.

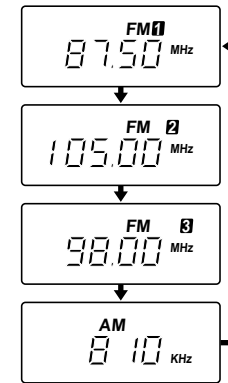

- 3 Press TUNING -/+ to tune the station you want.

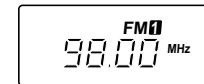

To turn off the radio

Press RADIO ON/OFF.

To tune the station quickly

Hold down TUNING -/+ in step 3. The frequency digits change quickly. When you release the button, the frequency digits change slowly. When the desired frequency digits appear, press TUNING -/+ again.

To improve broadcast reception

For FM, extend the headphones/earphones cord or adjust the DX/LOCAL.

For AM, reorient the unit itself.

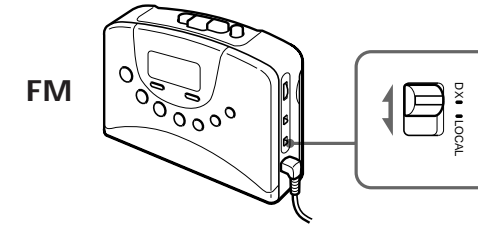

AM

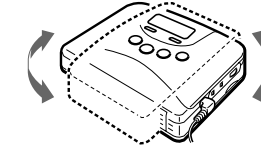

Note

If the broadcast becomes noisy when a cassette with a metallic shell or label is inserted, remove the cassette.

To listen to the radio abroad

The frequency range differs depending on the area. If you listen to the radio in an area of different frequency range, change the area indication in the display.

- 1 Press BAND for about 10 seconds while the radio is turned on.
- 2 Press TUNING - or + to change the area indication. ("U": U.S.A., Canada and Central and South America, "E": European and other countries).
- 3 Press BAND to set the frequency range.

Notes

- If you change the frequency range, all the preset stations will be canceled.
- When you want to cancel during a change of the area indication. Press BAND after pressing TUNING - or +, all the preset stations will be canceled.

To preset radio stations

You can store radio stations into the unit's memory. You can preset up to 20 radio stations, 5 for each FM1, FM2, FM3 or AM bands.

- 1 Press RADIO ON/OFF.



- 2 Tune in the desired station by using the BAND and TUNING - or +.

- 3 Press a preset number (1-5) for 2 seconds, the displayed frequency will flash with a beep sound and the station is stored.

If a station is already stored, the new station replaces the old one.

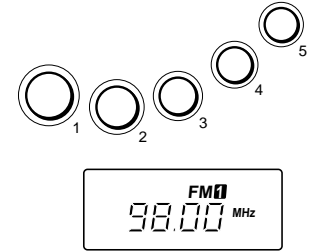

To play the preset radio stations

Press BAND to select the band, and then press the corresponding preset button.