

**USER MANUAL GUIDE  
GUIDE D'UTILISATION  
MODO DE EMPLEO**

**PORTABLE AIR CONDITIONER  
CLIMATISEUR MOBILE  
AIRE ACONDICIONADO PORTATIL**

**9,000BTU**

*Sunbeam*



**Model #KY-25/Y:  
9000 BTU PORTABLE  
DIGITAL AIR CONDITIONER  
WHITE METAL  
METAL BLANC  
METAL BLANCO**



**Model #KY-25/Y:  
9000 BTU PORTABLE  
DIGITAL AIR CONDITIONER  
STAINLESS STEEL  
ACIER INOXYDABLE  
ACERO INOXIDABLE**



# TABLE OF CONTENTS

<b>USE AND CARE GUIDE AND INSTALLATION INSTRUCTIONS</b> .....	1
<b>SECTION 1</b>	
<b>IMPORTANT SAFETY INSTRUCTIONS</b>	
1.1 PORTABLE AIR CONDITIONER SAFETY.....	2
1.2 DANGER AND WARNING.....	2
1.3 SAVE INSTRUCTIONS FOR FUTURE REFERENCE.....	2-3
1.4 SPECIAL RECOMMENDATIONS.....	4
1.5 ELECTRICAL REQUIREMENTS.....	4
1.6 RECOMMENDED GROUNDING METHOD.....	5
1.7 LCDI PLUG (US ONLY).....	5
1.8 UNPACKING YOUR PRODUCT PARTS.....	6
1.9 TECHNICAL SPECIFICATIONS.....	6
<b>SECTION 2</b>	
<b>A NOTE TO YOU</b>	
USER'S RECORD OF MODEL AND SERIAL NUMBER INFORMATION.....	7
<b>SECTION 3</b>	
<b>GETTING STARTED</b>	
3.1 TOOLS NEEDED.....	8
3.2 ACCESSORIES.....	8
3.3 POWER SUPPLY CORD AND RECEPTACLE.....	9
3.4 KNOWING YOUR PORTABLE AIR CONDITIONER.....	9
<b>SECTION 4</b>	
<b>INSTALLATION INSTRUCTIONS</b>	
4.1 PORTABLE AIR CONDITIONER INSTALLATION.....	10
4.2 ASSEMBLING THE AIR-EXHAUST DUCT.....	10
4.3 INSTALLING THE DUCTS IN THE WALL.....	11
<b>SECTION 5</b>	
<b>OPERATING YOUR PORTABLE AIR CONDITIONER</b>	
5.1 CONTROL PANEL AND OPERATING FUNCTIONS.....	12-13
5.2 LCD DISPLAY PANEL.....	13
5.3 OPERATING REMOTE CONTROL (MODEL KY-25Y ONLY).....	14-16
5.4 WATER FULL INDICATION AND DRAINING.....	16-17
<b>SECTION 6</b>	
<b>CARING FOR YOUR PORTABLE AIR CONDITIONER</b>	
6.1 MAINTENANCE.....	18
6.2 CLEANING OR REPLACING THE AIR FILTER.....	18
6.3 EXTERNAL PLASTIC PARTS.....	18
6.4 STORAGE AT THE END OF THE COOLING SEASON.....	18
<b>SECTION 7</b>	
<b>TROUBLESHOOTING</b>	
7.1 PORTABLE AIR CONDITIONER DOES NOT WORK AT ALL.....	19
7.2 LOW COOLING EFFICIENCY.....	19-20
7.3 NOISE AND VIBRATION.....	20
7.4 THE UNIT TURNS ON AND OFF FREQUENTLY.....	20
<b>SECTION 8</b>	
<b>ELECTRICAL DIAGRAM</b> .....	21
<b>SECTION 9</b>	
<b>WARRANTY</b> .....	22-23
<b>NOTES</b> .....	70-71

*Sunbeam.*

## 1.1 PORTABLE AIR CONDITIONER SAFETY

**Your safety and the safety of others are very important.**

We have provided many important safety messages in this manual and on your appliance. Always read and obey all safety messages.

## 1.2 DANGER AND WARNING



This is the safety alert symbol.



This symbol alerts you to potential hazards that can kill or hurt you and others.

All safety messages will follow the safety alert symbol and either the word “DANGER” or “WARNING”.

**⚠ DANGER**

**⚠ WARNING**

These words mean:

**You can be killed or seriously injured if you don't immediately follow instructions.**

All safety messages will tell you what the potential hazard is, tell you how to reduce the chance of injury, and tell you what can happen if the instructions are not followed.

## 1.3 SAVE THESE INSTRUCTIONS FOR FUTURE REFERENCE

**WARNING** – To reduce the risk of fire, electrical shock, injury, or sickness when using your portable air conditioner, follow these basic precautions:

- Plug into an exclusive grounded 3-prong outlet.
- Do not remove ground prong.
- Do not use an adapter.
- Use two or more people to move or install portable air conditioner.
- Do not drink the water collected inside the cabinet.
- Follow the instructions in this manual for cleaning the unit.
- Do not insert any objects into the unit.
- Always turn off the unit before unplugging it.
- Turn off and unplug the unit before cleaning or any other kind of servicing.
- Never repair the unit or change the cord by yourself. Any repair or manipulation to the unit carried out by a non qualified individual will void the guarantee.
- Do not place objects inside the air outlet or inlet grids. Do not block air outlet and/or inlet grids.
- Do not use this unit inside closets, cabinets and/or cramped spaces between furniture.
- Do not use this unit in proximity of inflammable and/or explosive substances.
- Do not operate this unit without filters. Keep the filters clean.
- Always turn this unit on and off using the ON/OFF switch.

# SECTION 1 IMPORTANT SAFETY INSTRUCTIONS

This portable air conditioner has been designed to create ideal climate in your room. Use it only for this specific purpose and according to the instructions in this manual.

This unit is intended for household consumer use only, and is not for commercial use.

Please use the unit in the recommended room size (refer to "Technical Specifications").

Do not place the air conditioner where furniture or other objects can obstruct the cooling airflow.

Set the unit to maximum cooling and high fan initially, then adjust the unit to a comfortable setting.

**Note:** It is recommended to turn on the air conditioner when the room temperature is around 75°F/23.9°C. Do not wait until the room is excessively hot.

**Note:** This unit is equipped with a thermostat, and should automatically turn on when the pre-set temperature is reached, but only if set in the Cooling Mode. If it is set in Soft-Dry or Fan Only, the compressor will not turn on.

## Please help us to help you:

- Make sure that your electric power voltage corresponds with the voltage on the nameplate of the unit.
- Keep children away from the unit.
- Check the electric cord periodically. Do not use a damaged electric cord.
- The cord length of this portable air conditioner is properly selected to reduce risk of danger. Do not use an extension cord.
- The unit should be located in a dry area.
- The unit is for indoor use only. Do not use outdoors.
- Only use the accessories supplied by the supplier. Using accessories from any source other than the supplier is dangerous and may damage the unit.
- Keep the unit away from any kind of heat source and direct sunlight - keep blinds/curtains closed during sunniest part of the day.
- Do not immerse the unit into water or any kind of liquid.
- Keep the unit away from any areas that have a chance of splashing water.
- To avoid the risk of shock, the unit should never be used in bathrooms, shower rooms or in any other steamy or wet areas.
- Do not use this unit at a slope - the unit is supported by four castors.
- In the event of fire, use Carbon Dioxide (CO<sub>2</sub>) extinguishers. Do not use water or powder extinguishers.

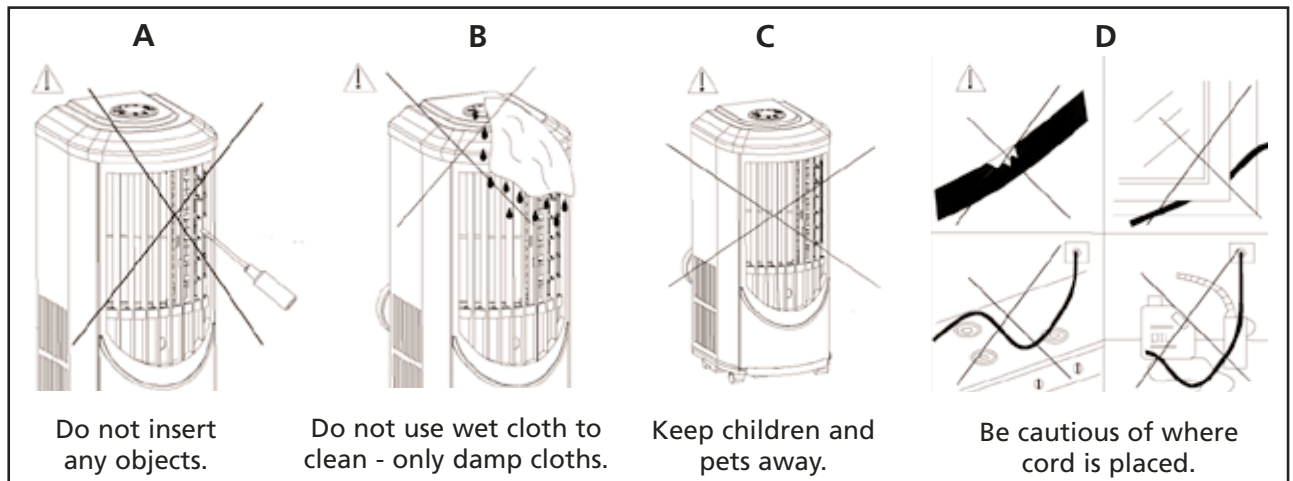

Figure 1

## 1.4 SPECIAL RECOMMENDATIONS

- Place the portable air conditioner in a level spot. Leave at least 20" (50.8 cm) between the unit and the wall.
- The plug should always be accessible after the unit is settled.
- In order to let the compressor work properly, always keep the portable air conditioner in a vertical position.
- Do not place the portable air conditioner near gas or any flammable liquids.
- Keep the unit far away from TVs or radios in order to avoid electromagnetic interference.
- Do not use any chemical sprays such as insecticides, painting or any flammable products near the unit. These chemical substances may interact with the plastic cabinet and warp it and cause electric interference.

## 1.5 ELECTRICAL REQUIREMENTS

### WARNING

#### Electrical Shock Hazard



Plug into a grounded (3-prong) outlet.  
Do not remove ground prong.  
Do not use an extension cord.  
Failure to follow these instructions can result in death,  
fire, or electrical shock.

**In the U.S. only: If codes permit and a separate ground wire is used, it is mandatory that the ground path is adequate.**

Check with a qualified electrician if you are not sure if the portable air conditioner is grounded.

A three-wire, single-phase, 60Hz AC only, electrical supply is required on a separate circuit. See model and serial label for circuit amperage required for your specific model.

If the portable air conditioner has a serial plate rating 115 Volts and up to and including 7.5 Amps, the unit may conflict with a fuse or circuit breaker with other devices.

**HOWEVER, THE MAXIMUM AMPS OF ALL DEVICES ON THAT FUSE OR CIRCUIT BREAKER CAN NOT EXCEED THE AMPS OF THE FUSE OR CIRCUIT BREAKER.**

If the portable air conditioner has a serial plate rating of 115 Volts and greater than 7.5 Amps it must have its own fuse or circuit breaker, and no other device or unit should be operated on that fuse or circuit breaker.

**NOTE:** The label lists the BTU capacity, amperage, voltage and refrigerant charge requirements.

# SECTION 1 IMPORTANT SAFETY INSTRUCTIONS

## 1.6 RECOMMENDED GROUNDING METHOD

For your personal safety, this portable air conditioner must be grounded. The portable air conditioner is equipped with a power supply cord with a 3-prong grounding plug. To minimize possible electrical shock hazard, the cord must be plugged into a mating 3-prong grounding type outlet, grounded in accordance with all local codes and ordinances. If a mating 3-prong type outlet is not available, it is the consumer's responsibility to have a properly grounded, 3-prong outlet installed by a licensed installer.

It is the customer's responsibility:

- To contact a qualified electrical installer.
- To assure that the electrical installation is adequate and in conformance with National Electrical Code, ANSI/NFPA 70 – latest edition, and all local codes and ordinances.

Copies of the standards listed may be obtained from:

National Fire Protection Association  
Batterymatch Park  
Quincy, Massachusetts 02269.  
Or your state board of electricity.

## 1.7 LCDI PLUG TECHNOLOGY (US ONLY)

A Leakage-Current Detect and Interrupt (LCDI) is a device that senses leakage current flowing between or from the power conductors in an appliance cord and interrupts the circuit as a predetermined level of leakage current. Since an LCDI specifically can detect a current leakage flowing to ground, it provides ground fault protection from arcing and other problems, which arise due to leakage between conductors.

LCDIs are covered under the UL 1699 standard for ARC Fault Current Interrupts, which was first published in June of 2002. LCDI devices have been mandated by the National Electric Code and Underwritten Laboratories for the cordsets on room air conditioners beginning in August 2004. Other classes of appliances will require LCDI protection in the near future.

### TESTING

1. Press test button, unit should trip.
2. Press reset button for use.

### NOTE: DO NOT USE IF ABOVE TEST FAILS.

In the event this device trips, the cause of the malfunction is to be corrected before use of the device.

### CAUTION

The conductors inside this cord are surrounded by shields, which monitor leakage current. THESE SHIELDS ARE NOT GROUNDED. Periodically examine the cord for any damage. DO NOT USE this product in the event the shields become exposed.

### WARNING

This product contains chemicals, including lead, known to the State of California to cause cancer, and birth defects or other reproductive harm.  
Wash hands after handling.

*Sunbeam*

# SECTION 1 IMPORTANT SAFETY INSTRUCTIONS

## 1.8 UNPACKING YOUR PRODUCT PARTS

When you get this unit, please transport the product in an upright position only, and place the product on an even surface. Remove the cardboard box without turning it upside down, or laying it on its side.

**Please note: If this unit is transported, it must be left in the normal up right position for at least 8 hours before using, to allow the coolant and compressor oil to settle.**

- Remove the adhesive tape on the top of the cardboard box.
- Open the cardboard box.
- Remove the Styrofoam packing and angle-protection board.
- Lift and hold the unit from the Styrofoam packing base by using two people, so as not to tilt the unit.
- Remove the plastic bag.
- Wipe it clean if necessary.
- Then install hot air exhaust duct for condenser side according to the installation instructions.

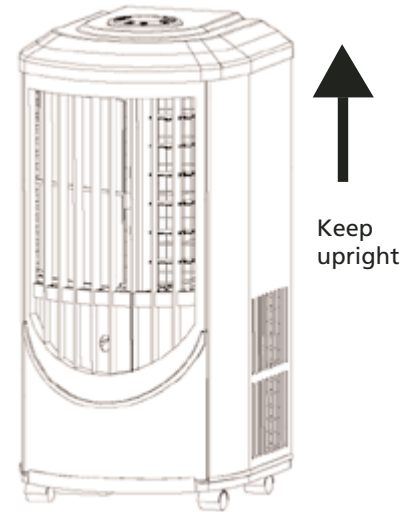

Figure 2

## 1.9 TECHNICAL SPECIFICATIONS

Model #	KY-25/Y
Color	Stainless Steel/White Metal
Rate Cooling Capacity	9000 BTU/hr
Voltage, Frequency, Phase	AC~115V/60Hz/1 PH
Rated Current	8.2A
Design Pressure	Max/High 370 psi, Min/Low 150psi
Refrigerant, Quantity	R22/500g (17.6oz)
Plug Capacity	125V/15A
Plug Type	5-15P
Cord Length	6.43ft/1.96M
Dehumidifying Amount	25.4oz/h / 0.75L/hour
Air Circulation Volume	5.67CMM/200CFM
Net Weight (Unit only)	24.75 kgs/54.56 lbs
Dimensions	13.8" L x 14"W x 31.42"H / 35.1cmL x 35.6cmW x 79.8cm H

**NOTE:**

The above data are obtained under the following conditions:

Cooling condition: Dry bulb/Wet bulb: 95°F/83°F (35°C/28.3°C) according to American standard 128-2001.

**Operating Limits During Cooling**

Maximum condition: Dry bulb/Wet bulb: 104°F/80°F (40°C/26.7°C)

Minimum condition: Dry bulb/Wet bulb: 64.4°F/57.2°F (18°C/14°C)

Thank you for buying this high quality Sunbeam® portable air conditioner. To ensure you enjoy years of trouble-free operation, we developed the Use and Care Guide. It contains valuable information about how to operate and maintain your appliance properly and safely. Please read it carefully.

Please record your model's information.

Whenever you call to request service on your appliance, you need to know your complete model number and serial number. You can find this information on the model and serial number label.

Please record the model and serial number information below. Also, record the purchase date of your appliance.

Model Number	_____
Serial Number	_____
Purchase Date	_____
Company Name	<b>Star Elite, a subsidiary of Elite Group</b>
Address	<b>1175 Place du Frère-André, Montréal, Québec H3B 3X9</b>
Telephone	<b>1-877-383-6399 (8:30am-5:30pm E.S.T.)</b>

**KEEP THIS BOOK AND  
THE ORIGINAL PROOF OF PURCHASE TOGETHER IN A SAFE PLACE FOR FUTURE REFERENCE.**

The label is placed  
on right side of unit

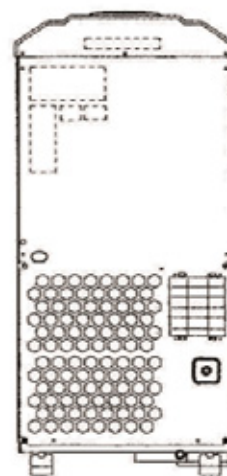

Back:  
Technical data  
Service call number and label  
Back:  
Warning label

**Figure 3**



## 3.1 TOOLS NEEDED

1. Flat-blade and Phillips screwdrivers
2. Gloves
3. Tape measure
4. Utility knife

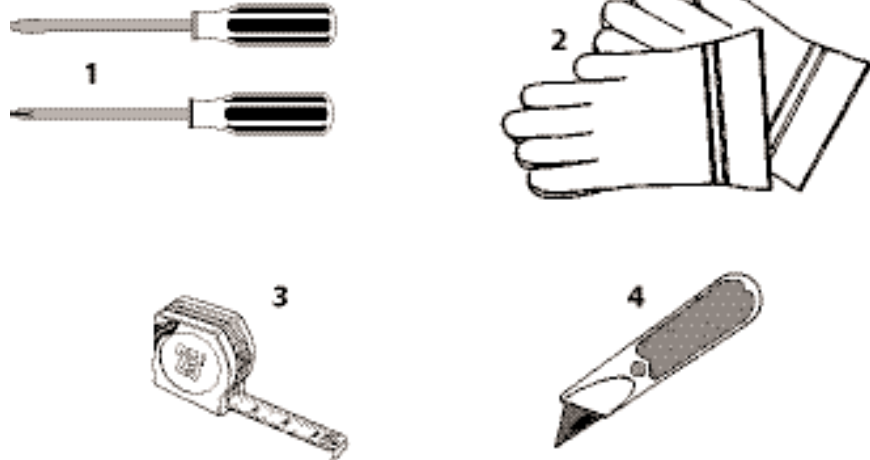

Figure 4

## 3.2 ACCESSORIES

1. Indoor terminal end
2. Exhaust duct
3. Window assembly kit
4. Main piece
5. Window kit adapter
6. Drain hose (2)



Figure 5

## 3.3 POWER SUPPLY CORD AND RECEPTACLE

- The plug should be well fixed and not damaged.
- Do not plug the unit with an adapter.
- Be sure the plug is fully inserted into the receptacle.
- The power cable must not come into contact with liquid of any kind; do not handle with damp or wet hands.
- Do not squeeze the cable or let it come into contact with a sharp surface.
- Do not use the power cables to drag the unit.
- Do not leave the cable in a tangled coil when it is working.
- Do not let the power cable come into contact with a hot surface.
- Do not leave the power cable in a high traffic area that will be more likely to lead to a damaged cord.



**Figure 6**

115 volt (103.5 min. - 126.5 max.) 0-12 amperes  
 15-amp time-delay fuse or circuit breaker  
 14 gauge copper wiring

## 3.4 KNOWING YOUR PORTABLE AIR CONDITIONER

**Front**

**Back**

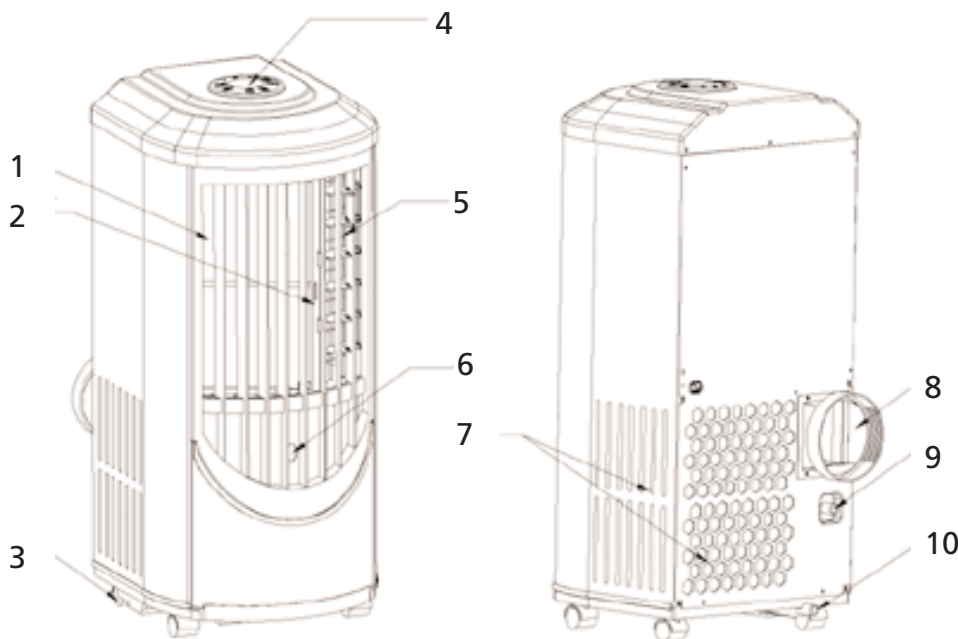

**Figure 7**

1. Air inlet
2. Air filter
3. Castor
4. Operation panel
5. Air outlet
6. Control signal receptor

7. Air inlet for condensor side
8. Hot air discharging port  
(Use to connect air hose)
9. Pump Drain
10. Lower drain port

## 4.1 PORTABLE AIR CONDITIONER INSTALLATION

- Find a proper place for the portable air conditioner.  
Leave at least 20" (50.8cm) space around the unit (Fig. 8).

When you use the unit as an air conditioner or a dehumidifier, the hot air must be exhausted out of the room to complete the air exchange of the condenser. When the unit is operating on fan, no outdoor air exchange takes place. You do not need to hook up the window kits and hot air exhaust ducts when you use the unit as a fan.

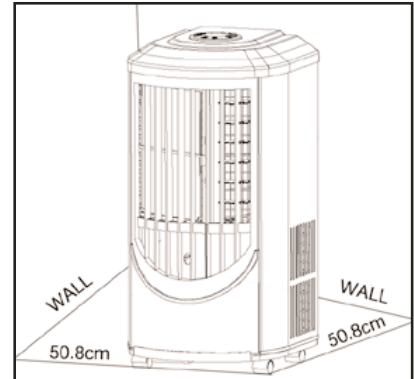

Figure 8

## 4.2 INSTALLING THE DUCTS IN A WINDOW/SLIDING DOOR

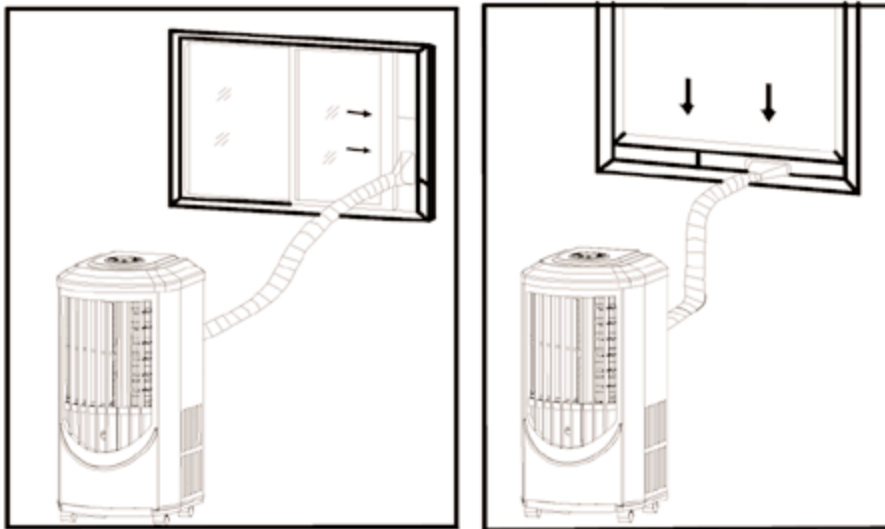

Figure 9

- Pull out both ends of the hot air exhaust ducts for approximately 6"/15.24cm.
- Screw the exhaust ducts clockwise with one end to the terminal end of the back of the unit and the other end to the window kit adapter.
- Mount the terminal end of the exhaust duct to the back of the unit.
- Open window or sliding door for approximately 5"/12.7cm.
- Adjust the length of the window kit to the same length of the window or the sliding door. Use all of the panels if necessary. Cut the window piece as needed to fit the length of your window or sliding door. Make sure that the hole on the main piece is not covered by other pieces.
- Place the window kit in the window or sliding door. Close the window or door as far as it goes.
- Adjust the length of exhaust duct and affix the window kit adapter onto the holes on the window kit.

**NOTE:** When using the window kit on a window or sliding door it will cause the window or sliding door to not be properly closed and/or locked. Additional security measurements should be taken.

## 4.3 INSTALLING THE DUCTS IN THE WALL

**! CAUTION**

**MANUFACTURER'S RECOMMENDATION.**  
**BEFORE UNDERTAKING ANY INSTALLATION OF DUCTS INTO WALL, WE RECOMMEND THAT YOU CONSULT A KNOWLEDGABLE PROFESSIONAL.**

- A) You do not need to use window kit adapter. Mount one end of the exhaust duct into a hole of 5.6"/14.22cm in diameter in the wall; attach the other end to the back of the unit (same as above).
- B) Use the exhaust outlet wall covers to cover the holes in the wall when the unit is not in use.

**NOTE:****Mounting the exhaust pipe**

- The supplied exhaust hose can extend from 5.75" to 63" / 40cm to 160cm for mounting. It is recommended that you use the shortest possible length of hose.
- Take care to prevent any kind of bend in the middle of the exhaust hose, as this will trap hot exhaust air, which will radiate back into the room and affect the cooling function of the unit (Fig. 10).

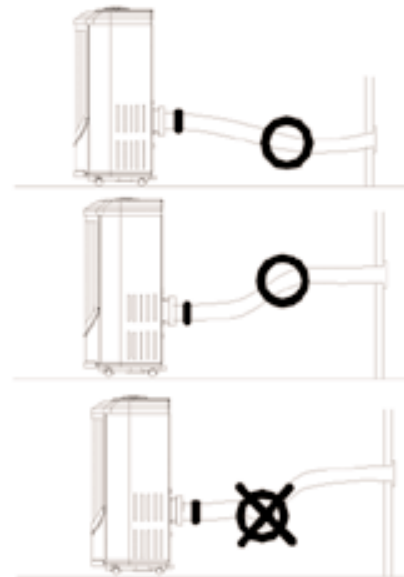

Figure 10

**! WARNING**

The length of the exhaust pipe is specially designed according to the specification of this product. Do not replace or extend it with your own hose as this could cause the unit to malfunction (Fig. 11).

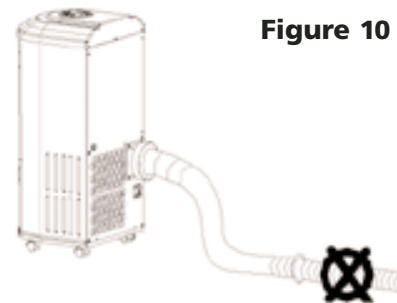

Figure 11

- C) After installing the ducts, plug in the unit and turn the unit on.

# SECTION 5 OPERATING YOUR PORTABLE AIR CONDITIONER

## 5.1 CONTROL PANEL AND OPERATING FUNCTIONS

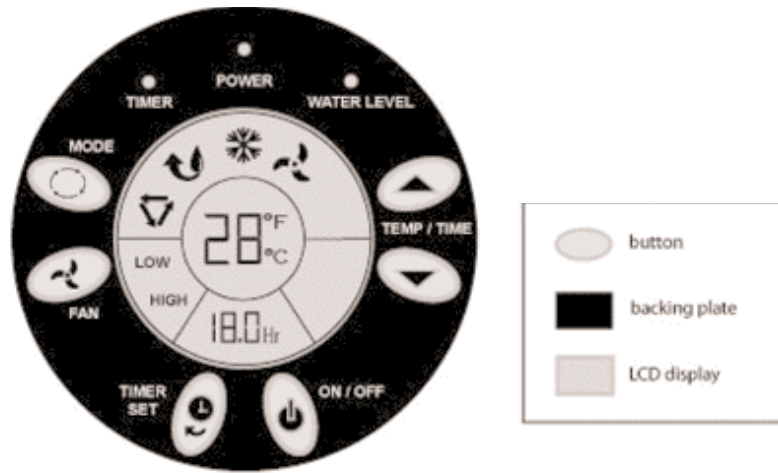

Figure 12

### ⚠ WARNING

If the unit is turned off during operation please wait at least three minutes before starting it again.



- 1) **On/Off Button:** Use to Start or Stop the unit.
- 2) **Operation Mode Selection Button:** Use to select the operation mode: **Auto** Mode, **Fan-Only** Mode, **Soft-Dry** Mode, and **Cooling** Mode.
- 3) **Fan Speed Selection Button:** Use to Select the fan speed: **High** speed or **Low** speed.
- 4) **"Up" or "Down": Temperature or Time Changing Button:** Use these two buttons to set to your desired temperature. The temperature unit can be on Fahrenheit or Centigrade. Press the **ON/OFF Button** for more than 20 seconds, then release. The temperature unit will be changed from Fahrenheit to Centigrade or vice versa. During the timer set-up, these buttons are also used to change the time.
- 5) **Timer Setting or Cancel Button:** Use to set or cancel **TIMER-ON** or **TIMER-OFF** timer. When the unit is on, the unit can be set with **Timer-OFF**. When the unit is off, the unit can be set with **Timer-ON**.



Sunbeam.

## SECTION 5 OPERATING YOUR PORTABLE AIR CONDITIONER

### 5.1 CONTROL PANEL AND OPERATING FUNCTIONS CONT'D

#### HOW TO SET:

When the unit is ON, press the  **Timer button**, "3.0Hr" will flash in **Timer Set Display Window** and the **Timer Indicator** will be on in the control panel. Pressing the  "Up" or the  "Down" button will change the time accordingly; the flashing digits will change accordingly, until your desired delay time appears. Your desired time delay will flash for ten (10) seconds. After these ten (10) seconds the digits will change to display your selected time delay. Time displayed will decrease in ten (6) minute increments.

When the unit is OFF, if it hasn't been set on Time Delay, press the  **Timer button**. The unit enters **Timer Program**. Also, the "3.0Hr" will flash in **Timer Set Display Window** and the Timer Indicator will be on in the control panel. Press the  "Up" or the  "Down" button to set to your desired time. When you are setting the time, the other settings like **Operation Mode**, **Fan Mode**, or **Set Temperature**, will also display. Ten (10) seconds later, these modes will disappear but be remembered by the Main Controller.

#### HOW TO CANCEL:

When the unit is set with the TIMER-OFF or the TIMER-ON procedures, press the  **Timer button** to check the Timer set time, then press within ten (10) seconds to cancel the timer setting.

### 5.2 LCD DISPLAY PANEL

-  Auto mode
-  Soft-dry mode
-  Cooling mode
-  Fan-only mode
-  Fahrenheit mode
-  Centigrade mode

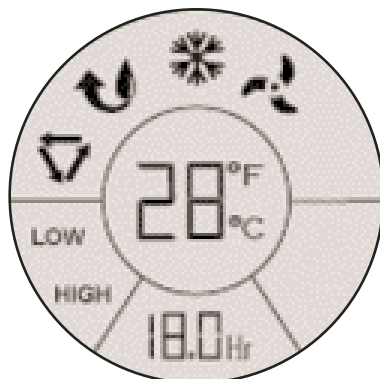

Figure 13

## SECTION 5 OPERATING YOUR PORTABLE AIR CONDITIONER

### 5.3 OPERATING REMOTE CONTROL (MODEL KY-25Y ONLY)

The functionality of the six (6) buttons on the Remote Control are identical to the functionality of the buttons on the Control Panel. Icons for certain buttons may differ slightly. The Remote Control uses the lithium batteries, Model: CR2025 (Included). Install the batteries before using the Remote Control.

You can operate the unit either on the Control Panel or with the Remote Control.

#### COOLING OPERATION:

- 1) Plug the Power Cord into the power outlet.
- 2) Turn on the unit by pressing the **ON/OFF Button** on the control panel or the remote control.
- 3) Press the **Mode Button** on the remote control or the control panel until the **❄** symbol appears on the display.
- 4) Set the room temperature to your desired room temperature with the temperature ranges from 64°F-90°F/18°C-32°C. Recommended temperatures are 80°F-84°F/27°C-29°C.
- 5) Select the fan speed by pressing the **Fan Button** on either the remote control or the control panel.

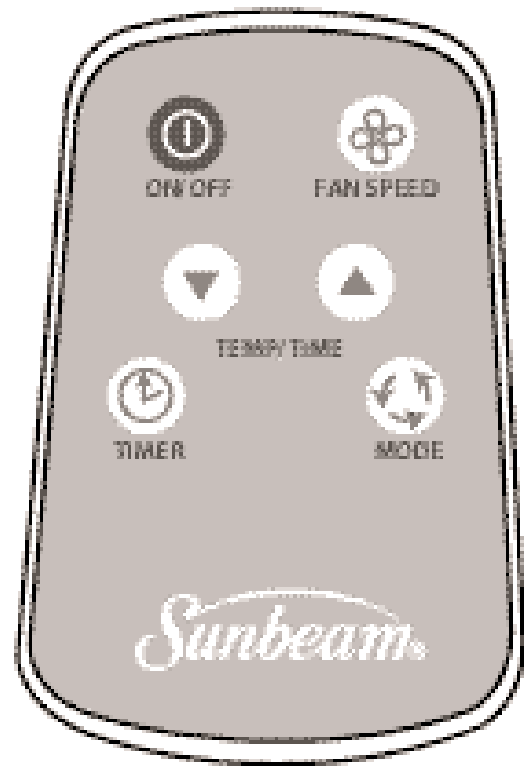

Figure 14

#### SOFT-DRY OPERATION:

- 1) Plug the Power Cord into the power outlet.
- 2) Turn on the unit by pressing the **ON/OFF Button** on the control panel or the remote control.
- 3) Press the **Mode Button** on the remote control or the control panel until the **💧** symbol appears on the display.
- 4) Set the room temperature to an appropriate temperature.
- 5) Keep the windows and the doors closed to aid the effectiveness of the unit in removing the moisture from the room.

**NOTE:** The unit will not perform its dehumidifying function when the room temperature is lower than 64°F/18°C. **Soft-Dry Mode** is a very gentle cooling operation consisting primarily of dehumidifying. It will not lower the room temperature very much. The indoor unit Fan always runs at Low speed.

## SECTION 5 OPERATING YOUR PORTABLE AIR CONDITIONER

### 5.3 OPERATING REMOTE CONTROL (MODEL KY-25Y ONLY) CONT'D...

#### FAN-ONLY OPERATION:

- 1) Plug the Power Cord into the power outlet.
- 2) Turn on the unit by pressing the **ON/OFF Button** on the control panel or the remote control.
- 3) Press the **Mode Button** on the remote control or the control panel until the symbol appears on the display.
- 4) Select the fan speed by pressing the **Fan Button** on either the remote control or the control panel.

When in **Fan-Only Mode**, the exhaust duct is not needed, and the compressor and condenser side fan motor will not work. Temperature setting has no meaning and no controlling action.

#### AUTO OPERATION:

- 1) Plug the Power Cord into the power outlet.
- 2) Turn on the unit by pressing the **ON/OFF Button** on the control panel or the remote control.
- 3) Press the **Mode Button** on the remote control or the control panel until the symbol appears on the display.
- 4) Set the room temperature to your desired room temperature with "Down" or "Up" **Temperature Changing Buttons**.
- 5) Select the fan speed by using the **FAN Speed button** on either the remote control or the control panel.

When in the **AUTO** mode, the unit will be in Fan-Only Mode when the room temperature is below 81°F/27°C. It will operate in Cooling Mode when the room temperature is above 81°F/27°C.

#### TIMER-ON PROGRAM SETTING:

##### How to set:

When the unit is off, you can set the timer to let the unit automatically turn on.

- 1) Press the **Timer Set Button** on the control panel or on the remote control. The "3.0hr" will flash in Timer Set Display Window, and the Timer Indicator, on the control panel, will turn on. The other mode settings like **Operation Mode, Fan Mode, Set Temperature Mode**, will also be displayed, allowing you to change or set them as well.
- 2) Press the "Down" button or the "Up" button to change the Timer delay time to your desired time.
- 3) After a ten (10) second delay (not pressing on any buttons), the digit will change to display, and the other setting modes will disappear. Now the Timer Setting Process is complete. Once some time has passed, the digits will decrease in 6 minute increments.

**When the digits decrease to ZERO and disappear, the unit will start to run automatically according to your setting.**

##### How to cancel:

When the unit is set with TIMER-ON while it's off, press the **Timer Button** on the control panel or on the remote control to check the Timer setting and the Time digits will flash. Press the **TIMER** button again; this will cancel the timed setting. The Timer Indicator on the control panel will then turn off.

Sunbeam







## SECTION 5 OPERATING YOUR PORTABLE AIR CONDITIONER

### 5.3 OPERATING REMOTE CONTROL (MODEL KY-25Y ONLY) CONT'D...



#### TIMER-OFF PROGRAM SETTING:

##### How to set:

When the unit is on, after being set with the TIMER-OFF, the unit will stop after your set delay time.

- 1) Press the **Timer Button** on the control panel  or on the remote control . Now the TIMER INDICATOR "3.0Hr" will flash in the Timer Set Display Window, and the Timer Indicator on the control panel will be on.
- 2) Press the  "Down" button or the  "Up" button to change the delay time to your desired time.
- 3) After a 10 second delay (not pressing on any buttons), the digits will change to display. The Timer Setting Process is complete. Once some time has passed, the digits will decrease in 10 minute increments.

##### How to cancel:

When the unit is set with TIMER-OFF, while the unit is on, first press **Timer Button** on the control panel  or on the remote control  to check the Timer setting and the Time digits will flash. Press the **TIMER button** again and the Timer Setting will be cancelled. The Timer Indicator on the control panel will then turn off.

### 5.4 WATER FULL INDICATION AND DRAINING

#### WATER FULL INDICATION:

**Under normal temperatures, water will evaporate without the need to drain it from the unit.**

The **WATER FULL** indicator light will turn on during days of extreme humidity, when in Cooling Mode or Soft-Dry Mode. When the **WATER FULL** indicator light turns on, it means that the water reservoir is full. The compressor will stop working, but both of the two fan motors will continue working. The unit will drain excess water once a Drain Hose or Garden Hose is connected to it. When the **WATER FULL** indicator light disappears, the compressor will start to work again.

#### DRAINING:

##### Only in extreme humidity

- 1) To add a Drain Hose or Garden Hose you must first stop the unit by turning it OFF. You must then unscrew the Drain Cap on the Pump Drain before inserting the white Drain Hose (5'3"/1.61m) provided with your unit. (**Attention: there may be some water behind the Drain Cap. Have a bowl or receptacle ready to catch any runoff.**)  
After connecting the Drain Hose to the inner spout (Fig.15) of the Pump Drain, ensure that the other end is placed in a bucket or receptacle for gathering the excess water. Check the water level in the receptacle to avoid any possibilities of leaking.  
Instead of the Drain Hose provided with your unit, you may also use a Garden Hose (in cases where you require a distance longer than that provided by the Drain Hose). In this case screw the female end of a Garden Hose to the outer threaded spout of the Pump Drain (Fig.16). After connecting the Garden Hose, place the outer end outside of the house or in a convenient area where the excess water can be safely expelled.
- 2) Now, turn the unit ON and back to its previous setting (either COOLING or SOFT-DRY mode). The Pump Drain will begin to pump water out of the unit. (If using a water bucket, please check the expelled water level to ensure that it does not over flow.) Once the WATER FULL light indicator turns off ... the DRAIN cycle is complete. At this point, turn OFF the unit, remove the Drain Hose or Garden Hose and then turn the unit back ON and to its previous setting (COOLING or SOFT-DRY mode).

Sunbeam

## 5.4 WATER FULL INDICATION AND DRAINING CONT'D...

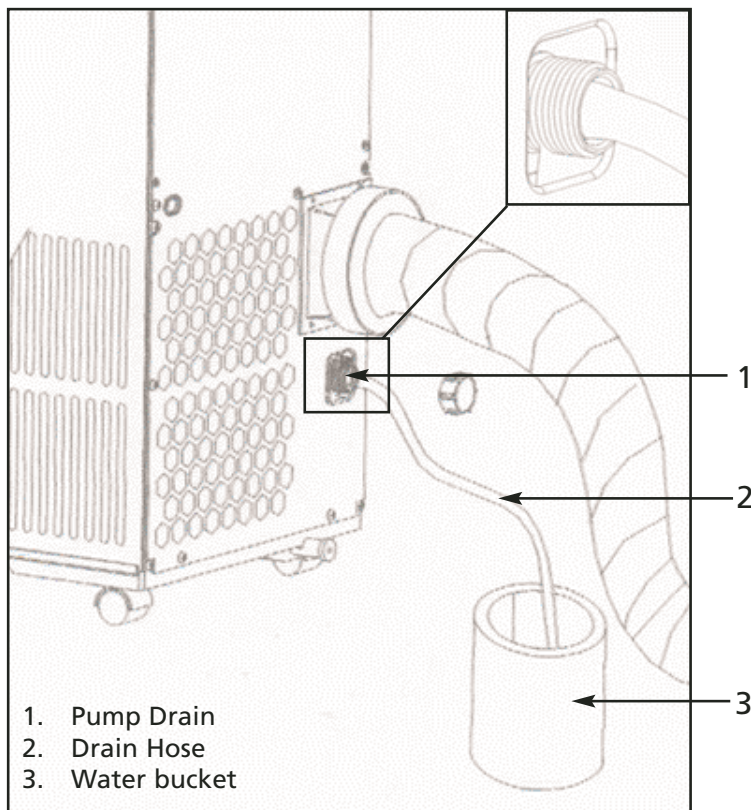

Figure 15

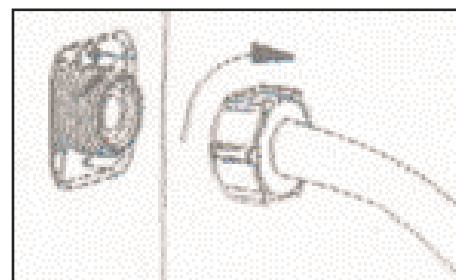

Figure 16

**NOTE:** The cooling efficiency of your unit will be affected if the Drain Hose or the Garden Hose is always attached to it. The Drain Hose or Garden Hose must be used only when the WATER FULL indicator is on.

**MAKE SURE THAT THE DRAIN CAP IS REINSTALLED PROPERLY TO PREVENT LEAKING.**

# SECTION 6 CARING FOR YOUR PORTABLE AIR CONDITIONER

## 6.1 MAINTENANCE

### **⚠ WARNING**

- Make sure the power supply is switched off and the plug is pulled out of the power outlet before performing any maintenance activities.
- Do not immerse the unit in water or other liquids.
- Do not pour liquids into the unit.
- Take special precaution to avoid the sharp cutting edges of some parts.
- Do not use any kind of chemical solvents to clean the unit, as they may deform the unit cabinet.

## 6.2 CLEANING OR REPLACING THE AIR FILTER

If the air filter is blocked with a lot of dust, the volume of airflow will be reduced and the cooling effect will be lower. It is recommended to clean the filter once every two weeks or as needed.

- A) Pull out the filter from the filter compartment in front of the unit.
- B) Wash the air filter by immersing it gently into warm (about 104°F/40°C) water with a gentle detergent. Rinse the filter and dry it thoroughly in a shaded place.
- C) Place the filter back into the filter compartment after it is thoroughly dried.
- D) If the filter is torn or unusable, order a new filter by calling the Sunbeam Customer Service department at 1-877-383-6399 (8:30am-5:30pm E.S.T.).

## 6.3 EXTERNAL PLASTIC PARTS

- A) Keep the unit from being exposed directly to the sun.
- B) Clean the surface with a damp cloth.
- C) For the Stainless Steel finished models, a good quality stainless steel cleaner should be used.

## 6.4 STORAGE AT THE END OF THE COOLING SEASON

- A) On a warm day, turn the unit on in the FAN-ONLY Mode for a couple of hours so that the inside can dry out completely.
- B) Turn off the unit and unplug the unit.
- C) Empty the residual condensed water by unplugging the LOWER WATER DRAINAGE CAP at the back towards the bottom of the unit. After connecting the 12'/3.65m white Drain Hose, ensure that the other end is in a bucket or receptacle for gathering the water.
- D) Discharge the Hot air duct and shorten it and pack it in the box.
- E) Clean the filter and dry it completely before fitting back in place.
- F) Cover the appliance to protect it from dust. It is recommended that the unit be put back into its original box and package.
- G) The unit should be stored in a cool dry place. Do not stack heavy objects on the top of the unit.

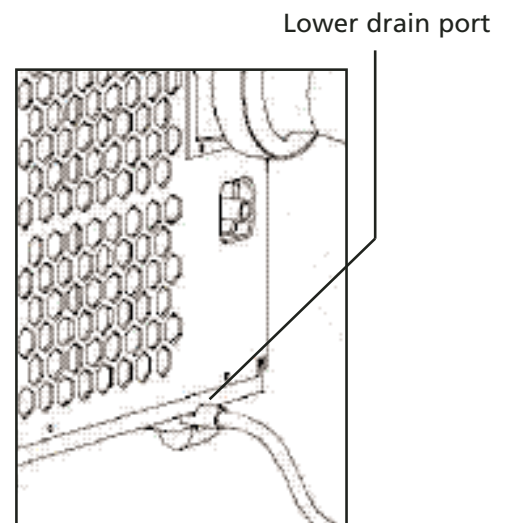

**Figure 17**

You can solve many common portable air conditioner problems easily, saving you the cost of a service call. Try the suggestions below to see if you can solve your problem without outside help.

**7.1 PORTABLE AIR CONDITIONER DOES NOT WORK AT ALL**

Check if...	Then...
The local power has failed.	Wait until local power is restored.
The plug is loose.	Firmly insert the plug into the wall socket.
The power fuse is burned.	Replace the fuse. Make sure the portable air conditioner is plugged into an exclusive properly grounded outlet as described in the Installation Instructions.
The water tank is full.	Drain out the water (see page 16).
LCDI plug has tripped.	Press the RESET button on the LCDI plug.
The time is set properly.	Set the proper time.
Water-Full Indicator is displayed.	Empty the water inside the unit (see page 16). Wait 1 hour to let the condenser side fan blow out the water.

**7.2 LOW COOLING EFFICIENCY**

Check if...	Then...
The air inlet or outlet is closed.	Open the air inlet and outlet.
There is a heat source in the room.	Move the heat source away.
The air filter is dirty.	Clean the air filter, referring to "Cleaning the Air Filter" section.
The cooling temperature is set properly.	Set the cooling temperature at a proper level.
The indoor fan is set at a low speed.	Set the indoor fan speed higher.



## 7.2 LOW COOLING CONT'D

Check if...	Then...
The outside temperature is lower than 64°F (18°C).	Do not operate your portable air conditioner in cooling mode when the outside temperature is lower than 64°F (18°C).
Windows and doors are open.	Close all doors and windows.
Unit is set at dehumidifying mode.	Set unit at cooling mode.

## 7.3 NOISE AND VIBRATION

Check if...	Then...
There is noise from the unit.	If the sound is not too high and comes from the compressor, the evaporator or the condenser, it is normal.
The unit is vibrating while working.	The unit is not on a flat place. Put the unit on a solid, flat place.

## 7.4 THE UNIT TURNS ON AND OFF FREQUENTLY

Check if...	Then...
The voltage of the local power is normal.	Wait until the local power is normal.
The hot air discharging port is properly installed.	Install the hot air discharging port properly as instructed in this manual.
The outside temperature is extremely hot.	Set the fan on high speed to let air pass cooling coils faster.

*Sunbeam*

© 2006 Sunbeam Products, Inc., doing business as Jarden Consumer Solutions.  
All rights reserved.

*Sunbeam* is a registered trademark of Sunbeam Products, Inc.,  
Manufactured in China for Star Elite, a division of the Elite Group, Inc., Quebec, Canada, H3B 3X9.

© 2006 Sunbeam Products, Inc., exploitée sous la raison sociale Jarden Consumer Solutions.  
Tout droits réservés.

*Sunbeam* est une marque déposée de Sunbeam Products, Inc., utilisée sous licence.  
Fabriqué en Chine pour Star Elite, une division de Elite Group, Inc., Quebec, Canada, H3B 3X9.

©2006 Sunbeam Products, Inc., funcionando bajo el nombre de Jarden Consumer Solutions.  
Todos los derechos reservados.

*Sunbeam* es una marca registrada de Sunbeam Products, Inc., usa bajo licencia.  
Fabricado por Star Elite, una subsidiaria de Elite Group Inc., Montréal, Canada H3B 3X9.

Star Elite  
1175 Place du Frère André  
Montreal, Quebec, Canada  
H3B 3X9  
Toll Free Tel / Tél. sans frais / Tel sin cargo:  
1-877-383-6399  
(8:30am-5:30pm E.S.T)  
(8h30-17h30 H.N.E)  
(8:30am-5:30pm E.S.T.E.)