



Product Manual

Constellation[®] CS Serial ATA

Standard Models

ST3000NC002
ST2000NC001
ST1000NC001

Seagate Instant Secure Erase Models

ST3000NC000
ST2000NC000
ST1000NC000

100695091
Rev. C
November 2012

Document Revision History

Revision	Date	Description of Change
Rev. A	07/18/2012	Initial release.
Rev. B	10/05/2012	8-10 & 18.
Rev. C	11/13/2012	5, 16 & 19.

© 2012 Seagate Technology LLC. All rights reserved.

Publication number: 100695091, Rev. C November 2012

Seagate, Seagate Technology and the Wave logo are registered trademarks of Seagate Technology LLC in the United States and/or other countries. Constellation CS and SeaTools are either trademarks or registered trademarks of Seagate Technology LLC or one of its affiliated companies in the United States and/or other countries. The FIPS logo is a certification mark of NIST, which does not imply product endorsement by NIST, the U.S., or Canadian governments. All other trademarks or registered trademarks are the property of their respective owners.

No part of this publication may be reproduced in any form without written permission of Seagate Technology LLC. Call 877-PUB-TEK1 (877-782-8351) to request permission.

When referring to drive capacity, one gigabyte, or GB, equals one billion bytes and one terabyte, or TB, equals one trillion bytes. Your computer's operating system may use a different standard of measurement and report a lower capacity. In addition, some of the listed capacity is used for formatting and other functions, and thus will not be available for data storage. Actual quantities will vary based on various factors, including file size, file format, features and application software. Actual data rates may vary depending on operating environment and other factors. The export or re-export of hardware or software containing encryption may be regulated by the U.S. Department of Commerce, Bureau of Industry and Security (for more information, visit www.bis.doc.gov), and controlled for import and use outside of the U.S. Seagate reserves the right to change, without notice, product offerings or specifications.

Contents

Seagate® Technology Support Services	1
---	----------

1.0 Introduction	2
1.1 About the SATA interface	3

2.0 Drive Specifications	4
2.1 Specification summary tables	4
2.2 Formatted capacity	5
2.2.1 LBA mode	6
2.3 Default logical geometry	6
2.4 Recording and interface technology	6
2.5 Physical characteristics	6
2.6 Seek time	7
2.7 Start/stop times	7
2.8 Power specifications	7
2.8.1 Power consumption	7
2.8.2 Conducted noise	12
2.8.3 Voltage tolerance	12
2.8.4 Power-management modes	13
2.9 Environmental limits	16
2.9.1 Ambient temperature	16
2.9.2 Humidity	16
2.9.3 Altitude	17
2.9.4 Shock	17
2.9.5 Vibration	17
2.10 Acoustics	18
2.11 Test for Prominent Discrete Tones (PDTs)	18
2.12 Electromagnetic immunity	18
2.13 Reliability	19
2.13.1 Annualized Failure Rate (AFR) and Mean Time Between Failures (MTBF)	19
2.14 Agency certification	19
2.14.1 Safety certification	19
2.14.2 Electromagnetic compatibility	19
2.14.3 FCC verification	20
2.15 Environmental protection	21
2.15.1 European Union Restriction of Hazardous Substances (RoHS) Directive	21
2.15.2 China Restriction of Hazardous Substances (RoHS) Directive	21
2.16 Corrosive environment	21
2.17 Product warranty	21

3.0 Configuring and Mounting the Drive	23
3.1 Handling and static-discharge precautions	23
3.2 Configuring the drive	23
3.3 SATA cables and connectors	23
3.4 Drive mounting	24

4.0 About Seagate Instant Secure Erase drives	25
4.1 Data encryption	25
4.2 Cryptographic erase	25
4.3 Power requirements	25
4.4 RevertSP	25
4.5 ATA Security Erase Unit Command on SED SATA drives	25
4.6 Sanitize Feature Set on SED Drives	25

5.0	SATA Interface	26
5.1	Hot-Plug compatibility	26
5.2	SATA device plug connector pin definitions	27
5.3	Supported ATA commands	28
5.3.1	Identify Device command	30
5.3.2	Set Features command	33
5.3.3	S.M.A.R.T. commands	34

Figures

Figure 1	Typical 3TB model 5V - 6Gb/s startup and operation current profile	9
Figure 2	Typical 3TB model 12V - 6Gb/s startup and operation current profile	9
Figure 3	Typical 2TB model 12V - 6Gb/s startup and operation current profiles	10
Figure 4	Typical 1TB model 12V - 6Gb/s startup and operation current profiles	11
Figure 5	Location of the HDA temperature check point	16
Figure 6	Attaching SATA cabling.	23
Figure 7	Mounting dimensions	24

Seagate® Technology Support Services

For information regarding online support and services, visit <http://www.seagate.com/about/contact-us/technical-support/>

Available services include:

- Presales & Technical support
- Global Support Services telephone numbers & business hours
- Authorized Service Centers

For information regarding Warranty Support, visit <http://www.seagate.com/support/warranty-and-returns/>

For information regarding data recovery services, visit <http://www.seagate.com/services-software/data-recovery-services/>

For Seagate OEM and Distribution partner portal, visit <https://direct.seagate.com/portal/system>

For Seagate reseller portal, visit <http://spp.seagate.com>

1.0 Introduction

This manual describes the functional, mechanical and interface specifications for the following Seagate Constellation® CS Serial ATA model drives:

Model Number	Seagate Instant Secure Erase (ISE)
ST3000NC002	No
ST3000NC000	Yes
ST2000NC001	No
ST2000NC000	Yes
ST1000NC001	No
ST1000NC000	Yes

These drives provide the following key features:

- 7200 RPM spindle speed.
- PowerChoice™ for selectable power savings
- High instantaneous (burst) data-transfer rates (up to 600MB per second).
- Perpendicular recording technology provides the drives with increased areal density.
- State-of-the-art cache and on-the-fly error-correction algorithms.
- Native Command Queueing with command ordering to increase performance in demanding applications.
- Full-track multiple-sector transfer capability without local processor intervention.
- SeaTools™ diagnostic software performs a drive self-test that eliminates unnecessary drive returns.
- Support for S.M.A.R.T. drive monitoring and reporting.
- Supports latching SATA cables and connectors.
- Worldwide Name (WWN) capability uniquely identifies the drive.

1.1 About the SATA interface

The Serial ATA (SATA) interface provides several advantages over the traditional (parallel) ATA interface. The primary advantages include:

- Easy installation and configuration with true plug-and-play connectivity. It is not necessary to set any jumpers or other configuration options.
- Thinner and more flexible cabling for improved enclosure airflow and ease of installation.
- Scalability to higher performance levels.

In addition, SATA makes the transition from parallel ATA easy by providing legacy software support. SATA was designed to allow you to install a SATA host adapter and SATA disk drive in your current system and expect all of your existing applications to work as normal.

The SATA interface connects each disk drive in a point-to-point configuration with the SATA host adapter. There is no master/slave relationship with SATA devices like there is with parallel ATA. If two drives are attached on one SATA host adapter, the host operating system views the two devices as if they were both “masters” on two separate ports. This essentially means both drives behave as if they are Device 0 (master) devices.

Note

The host adapter may, optionally, emulate a master/slave environment to host software where two devices on separate SATA ports are represented to host software as a Device 0 (master) and Device 1 (slave) accessed at the same set of host bus addresses. A host adapter that emulates a master/slave environment manages two sets of shadow registers. This is not a typical SATA environment.

The SATA host adapter and drive share the function of emulating parallel ATA device behavior to provide backward compatibility with existing host systems and software. The Command and Control Block registers, PIO and DMA data transfers, resets, and interrupts are all emulated.

The SATA host adapter contains a set of registers that shadow the contents of the traditional device registers, referred to as the Shadow Register Block. All SATA devices behave like Device 0 devices. For additional information about how SATA emulates parallel ATA, refer to the “Serial ATA International Organization: Serial ATA Revision 3.0”. The specification can be downloaded from www.sata-io.org.

2.0 Drive Specifications

Unless otherwise noted, all specifications are measured under ambient conditions, at 25°C, and nominal power. For convenience, the phrases *the drive* and *this drive* are used throughout this manual to indicate the following drive models:

Standard models	Seagate In(SED) models
ST3000NC002	ST3000NC000
ST2000NC001	ST2000NC000
ST1000NC001	ST1000NC000

2.1 Specification summary tables

The specifications listed in [Table 1](#).

For details on specification measurement or definition, refer to the appropriate section of this manual.

Table 1 Drive specifications summary for 3TB, 2TB and 1TB models

Drive Specification*	ST3000NC002 ST3000NC000	ST2000NC001 ST2000NC000	ST1000NC001 ST1000NC000
Formatted capacity (512 bytes/sector)*	3000GB (3TB)	2000GB (2TB)	1000GB (1TB)
Guaranteed sectors	5,860,533,168	3,907,029,168	1,953,525,168;
Heads	6	4	2
Disks	3	2	1
Bytes per sector	4096 (512 byte emulation)		
Default sectors per track	63		
Default read/write heads	16		
Default cylinders	16,383		
Recording density, KBPI (Kb/in max)	1807		
Track density, KTPI (ktracks/in avg.)	340		
Areal density, (Gb/in ² avg)	625		
Spindle speed (RPM)	7200		
Internal data transfer rate (Mb/s max)	2147		
Sustained data transfer rate OD (MB/s)	150 to 180		
I/O data-transfer rate MB/s max)	600		
ATA data-transfer modes supported	PIO modes 0–4 Multiword DMA modes 0–2 Ultra DMA modes 0–6		
Cache buffer	64MB		
Height (max)	26.1mm / 1.028 in		20.17mm / 0.7825 in
Width (max)	101.85mm / 4.010 in		
Length (max)	147.00mm / 5.787 in		
Weight (typical)	626g (1.38 lb)	535g (1.18 lb)	400g (0.88 lb)
Average latency	4.16ms		
Power-on to ready (sec max)	15.0	10.0	7.0
Standby to ready (sec max)	15.0	10.0	7.0
Track-to-track seek time (ms typical)	0.5 read 0.8 write		
Average seek, read (ms typical)	9.5		
Average seek, write (ms typical)	10.5		
Startup current (typical) 12V (peak)	2.8A 2.0A (optional configuration through Smart Command Transport)		
Voltage tolerance (including noise)	5V: ± 5% 12V: ± 10%		

Table 1 Drive specifications summary for 3TB, 2TB and 1TB models (Continued)

Drive Specification*	ST3000NC002 ST3000NC000	ST2000NC001 ST2000NC000	ST1000NC001 ST1000NC000
Temperature gradient (°C per hour max)	20°C (operating) 30°C (non-operating)		
Relative humidity	5% to 90% (operating) 5% to 95% (non-operating)		
Relative humidity gradient (per hour max)	30%		
Altitude, operating	-304.80 m to 3048 m (-1000 ft to 10,000+ ft)		
Altitude, non-operating (below mean sea level, max)	-304.80 m to 12,192 m (-1000 ft to 40,000+ ft)		
Operational Shock (max @ 2 ms)	Read 70 Gs / Write 40 Gs		
Non-Operational Shock (max @ 2 ms))	300 Gs		350 Gs
Vibration, operating	5–22 Hz: 0.25 Gs, Limited displacement 22–350 Hz: 0.50 Gs 350–500 Hz: 0.25 Gs		
Vibration, non-operating	5Hz to 22Hz: 3.0 Gs 22Hz to 350Hz: 3.0 Gs 350Hz to 500Hz: 3.0 Gs		
Drive acoustics, sound power (bels)			
Idle**	2.5 (typical) 2.6 (max)	2.4 (typical) 2.5 (max)	2.2 (typical) 2.3 (max)
Performance seek	2.5 (typical) 2.6 (max)	2.4 (typical) 2.5 (max)	2.2 (typical) 2.3 (max)
Non-recoverable read errors	1 per 10 ¹⁴ bits read		
Annualized Failure Rate (AFR)	1.095% based on 8760 POH		
Warranty	To determine the warranty for a specific drive, use a web browser to access the following web page: http://www.seagate.com/support/warranty-and-returns/ From this page, click on the “Verify Your Warranty” link. You will be asked to provide the drive serial number, model number (or part number) and country of purchase. The system will display the warranty information for your drive.		
Load/Unload cycles (25°C, 50% rel. humidity)	300,000		
Supports Hotplug operation per the Serial ATA Rev. 3.0 specification	Yes		

* One GB equals one billion bytes and 1TB equals one trillion bytes when referring to hard drive capacity. Accessible capacity may vary depending on operating environment and formatting.

** During periods of drive idle, some offline activity may occur according to the S.M.A.R.T. specification, which may increase acoustic and power to operational levels.

2.2 Formatted capacity

Model	Formatted capacity*	Guaranteed sectors	Bytes per sector
ST3000NC002 ST3000NC000	3TB	5,860,533,168	4096 (512 byte emulation)
ST2000NC001 ST2000NC000	2TB	3,907,029,168	
ST1000NC001 ST1000NC000	1TB	1,953,525,168	

*One GB equals one billion bytes and 1TB equals one trillion bytes when referring to hard drive capacity. Accessible capacity may vary depending on operating environment and formatting.

2.2.1 LBA mode

When addressing these drives in LBA mode, all blocks (sectors) are consecutively numbered from 0 to $n-1$, where n is the number of guaranteed sectors as defined above.

See Section 5.3.1, "Identify Device command" (words 60-61 and 100-103) for additional information about 48-bit addressing support of drives with capacities over 137GB.

2.3 Default logical geometry

- Cylinders: 16,383
- Read/write heads: 16
- Sectors per track: 63

LBA mode

When addressing these drives in LBA mode, all blocks (sectors) are consecutively numbered from 0 to $n-1$, where n is the number of guaranteed sectors as defined above.

2.4 Recording and interface technology

Interface	Serial ATA (SATA)
Recording method	Perpendicular
Recording density, KBPI (Kb/in max)	1807
Track density, KTPI (ktracks/in avg)	340
Areal density (Gb/in ² avg)	625
Spindle speed (RPM) (\pm 0.2%)	7200
Internal data transfer rate (Mb/s max)	2147
Sustained data transfer rate (MB/s)	150 to 180
I/O data-transfer rate (MB/s max)	600 (Ultra DMA mode 5)

2.5 Physical characteristics

Weight: (maximum)	
3TB models	626g (1.38 lb)
2TB models	535g (1.18 lb)
1TB models	400g (0.88lb)
Cache buffer	64MB (64,768KB)

2.6 Seek time

Seek measurements are taken with nominal power at 25°C ambient temperature. All times are measured using drive diagnostics. The specifications in the table below are defined as follows:

- Track-to-track seek time is an average of all possible single-track seeks in both directions.
- Average seek time is a true statistical random average of at least 5000 measurements of seeks between random tracks, less overhead.

Typical seek times (ms)	Read	Write
Track-to-track	0.5	0.8
Average	9.5	10.5
Average latency	4.16	

Note

These drives are designed to consistently meet the seek times represented in this manual. Physical seeks, regardless of mode (such as track-to-track and average), are expected to meet the noted values. However, due to the manner in which these drives are formatted, benchmark tests that include command overhead or measure logical seeks may produce results that vary from these specifications.

2.7 Start/stop times

	3TB models	2TB models	1TB models
Power-on to ready (sec)	15 (max)	10 (max)	7.0 (max)
Standby to ready (sec)	15 (max)	10 (max)	7.0 (max)
Ready to spindle stop (sec)	20 (max)		

2.8 Power specifications

The drive receives DC power (+5V or +12V) through a native SATA power connector. Refer to [Figure 6 on page 23](#).

2.8.1 Power consumption

Power requirements for the drives are listed in [Table 2](#). Typical power measurements are based on an average of drives tested, under nominal conditions, using 5.0V and 12.0V input voltage at 25°C ambient temperature.

- Spinup power
Spinup power is measured from the time of power-on to the time that the drive spindle reaches operating speed.
- Seek mode
During seek mode, the read/write actuator arm moves toward a specific position on the disc surface and does not execute a read or write operation. Servo electronics are active. Seek mode power represents the worst-case power consumption, using only random seeks with read or write latency time. This mode is not typical and is provided for worst-case information.
- Read/write power and current
Read/write power is measured with the heads on track, based on a 16-sector write followed by a 32-ms delay, then a 16-sector read followed by a 32-ms delay.
- Operating power and current
Operating power is measured using 40 percent random seeks, 40 percent read/write mode (1 write for each 10 reads) and 20 percent drive idle mode.
- Idle mode power
Idle mode power is measured with the drive up to speed, with servo electronics active and with the heads in a random track location.
- Standby mode
During Standby mode, the drive accepts commands, but the drive is not spinning, and the servo and read/write electronics are in power-down mode..

Table 2: 3TB Drive DC power requirements

		3.0Gb mode		6.0Gb mode		
Voltage		+5V	+12V	+5V	+12V	
Regulation		±5%	±5%	±5%	±5%	
Avg Idle Current *		0.28	0.34	0.29	0.34	
Advanced Idle Current *						
	Idle_A	0.17	0.34	0.18	0.34	
	Idle_B	0.15	0.30	0.16	0.30	
	Idle_C	0.15	0.19	0.16	0.19	
	Standby	0.12	0.01	0.13	0.01	
Average Sleep Current		0.12	0.01	0.13	0.01	
Maximum Start Current						
	DC (peak DC)	3 σ	0.45	1.16	0.45	1.16
	AC (peak DC)	3 σ	0.68	1.94	0.70	1.95
	Delayed Motor Start (DC max)	3 σ	0.13	0.01	0.14	0.01
Peak operating current (random read):						
	Typical DC		0.31	0.52	0.32	0.52
	Maximum DC	3 σ	0.33	0.53	0.34	0.53
	Maximum DC(peak)	3 σ	1.83	1.56	1.80	1.56
Peak operating current (random write)						
	Typical DC		0.31	0.37	0.33	0.37
	Maximum DC	3 σ	0.33	0.38	0.34	0.39
	Maximum DC(peak)	3 σ	2.32	2.49	2.29	1.46
Peak operating current (sequential read)						
	Typical DC		0.61	0.37	0.62	0.37
	Maximum DC	3 σ	0.64	0.38	0.65	0.39
	Maximum DC(peak)	3 σ	1.20	2.24	1.19	1.84
Peak operating current (sequential write)						
	Typical DC		0.54	0.42	0.55	0.42
	Maximum DC	3 σ	0.57	0.43	0.58	0.43
	Maximum DC(peak)	3 σ	0.79	1.77	0.90	2.40

*During periods of drive idle, some offline activity may occur according to the S.M.A.R.T. specification, which may increase acoustic and power to operational levels.

2.8.1.1 Typical current profiles

3TB model current profile

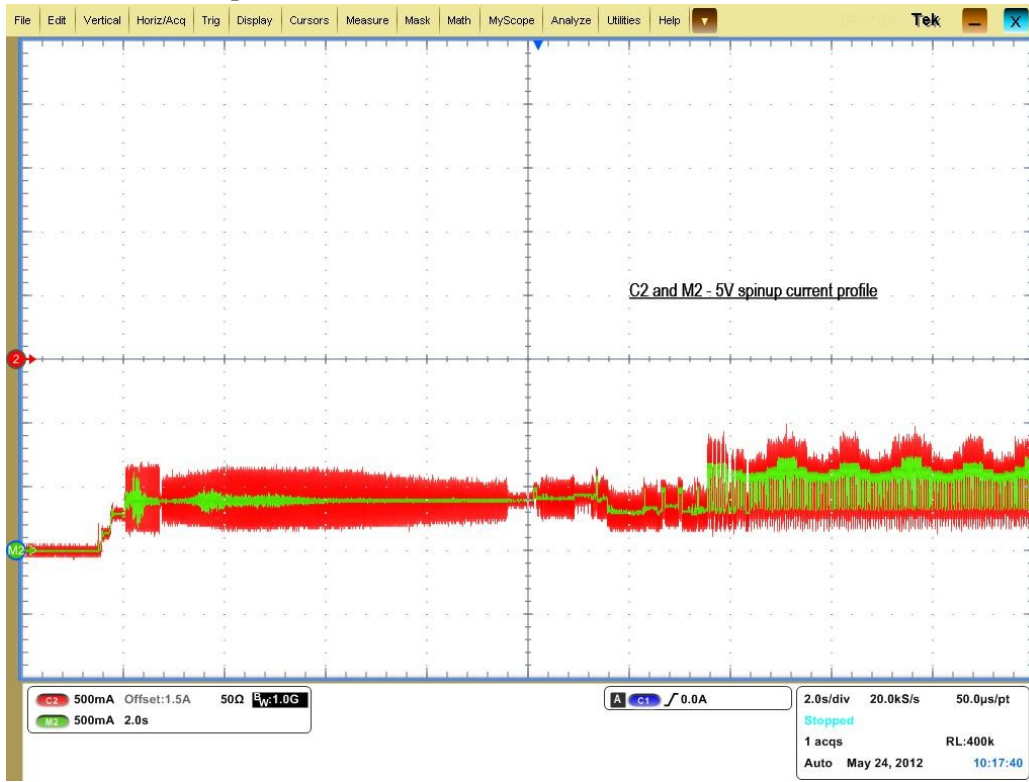

Figure 1 Typical 3TB model 5V - 6Gb/s startup and operation current profile

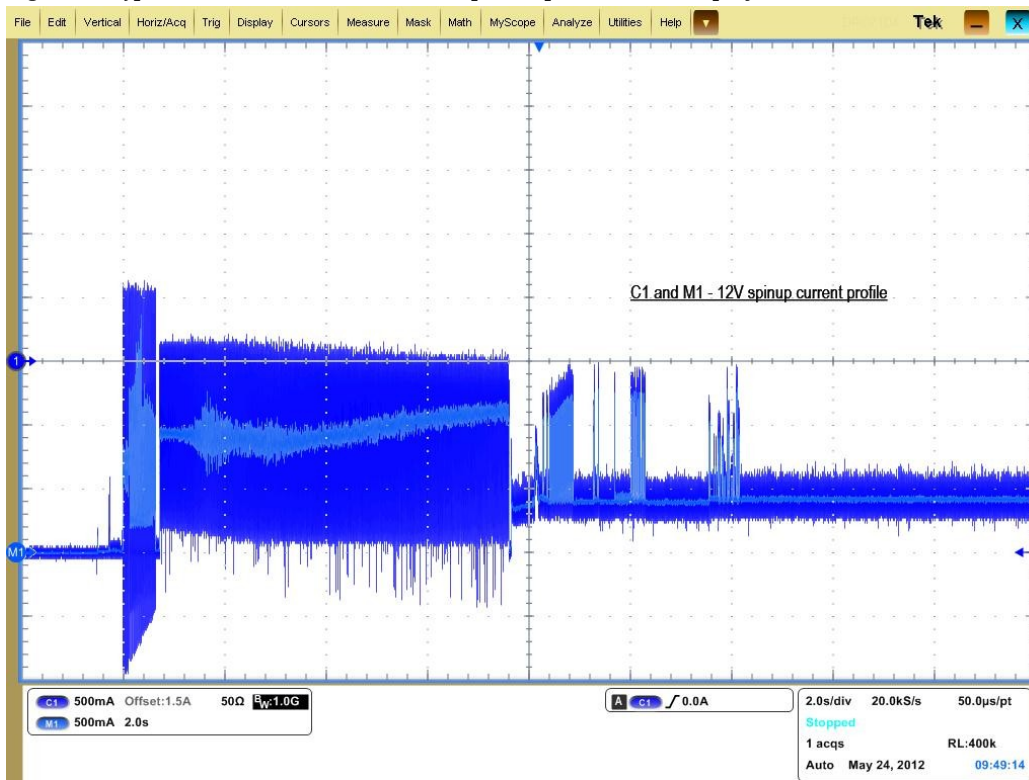
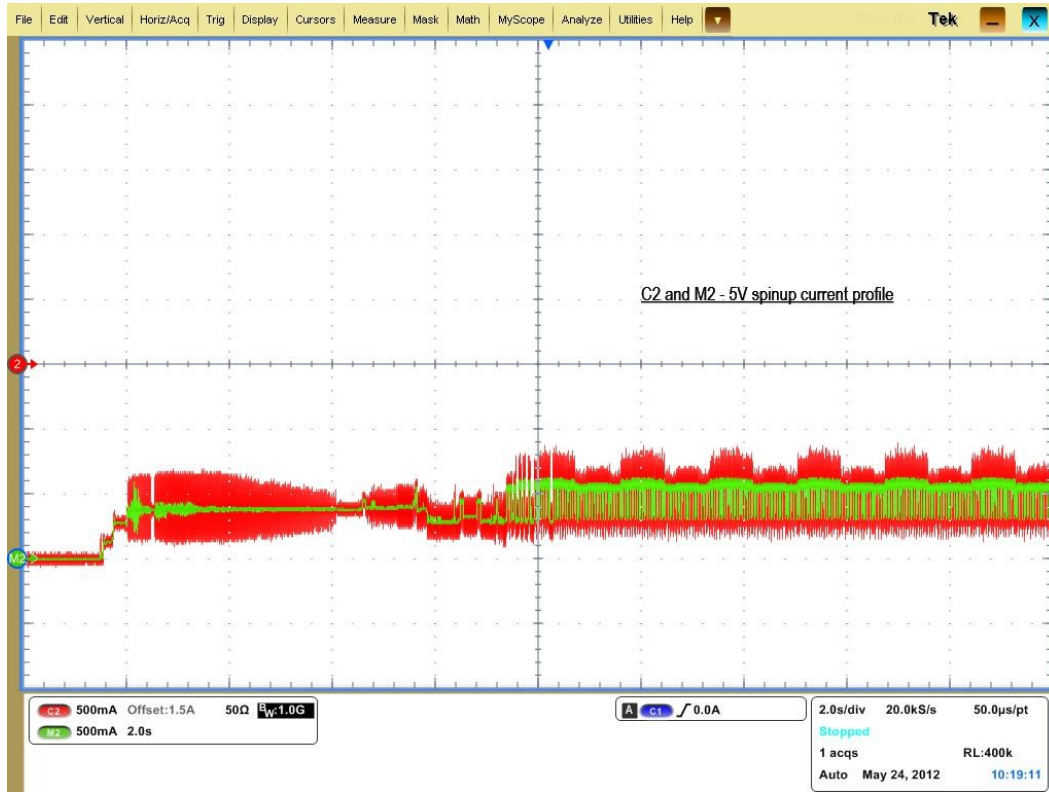

Figure 2 Typical 3TB model 12V - 6Gb/s startup and operation current profile

2TB model current profile



Typical 2TB model 5V - 6Gb/s startup and operation current profiles

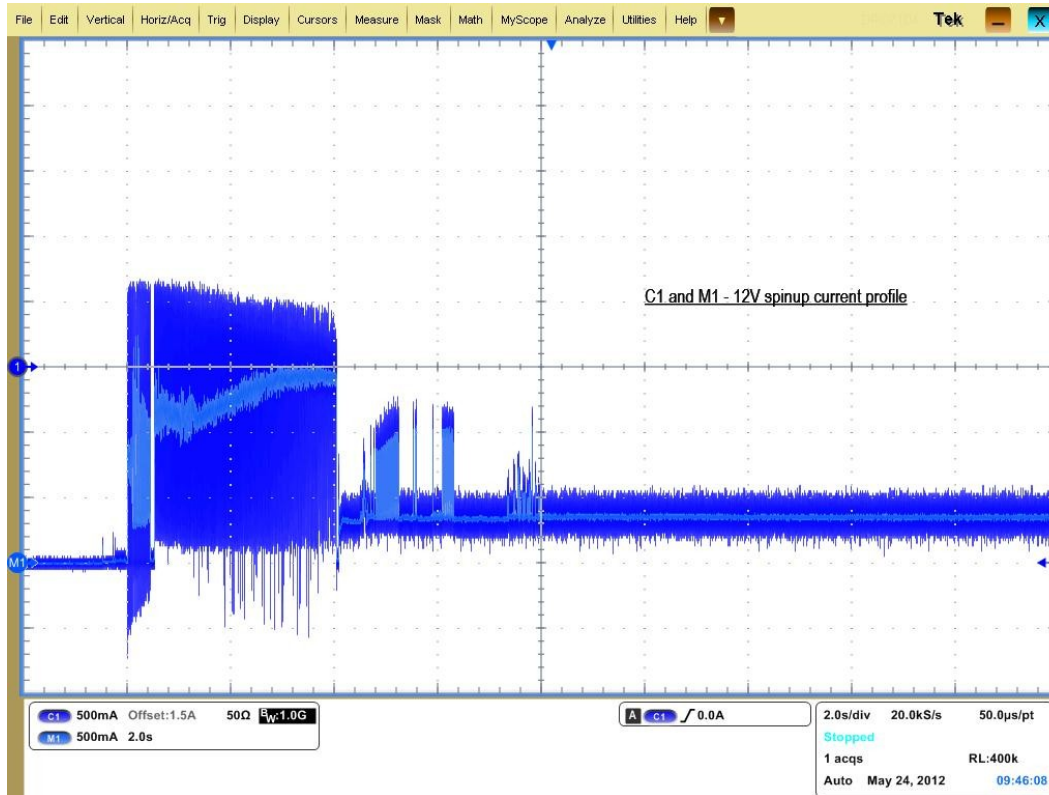
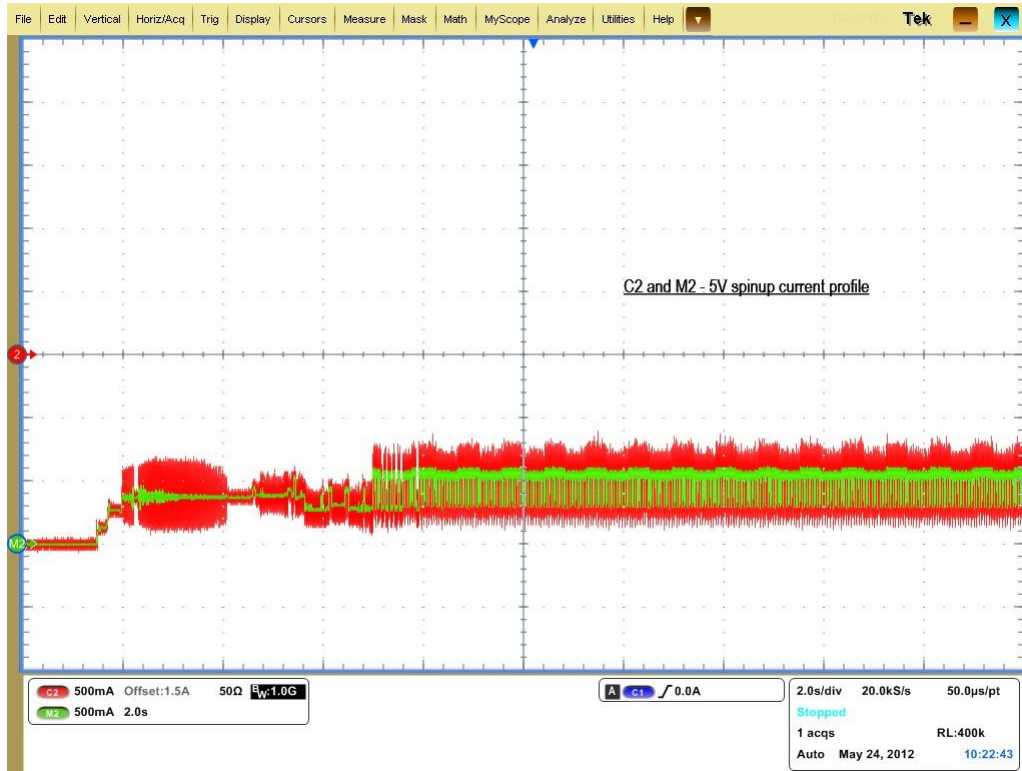

Figure 3 Typical 2TB model 12V - 6Gb/s startup and operation current profiles

1TB model current profile



Typical 1TB model 5V - 6Gb/s startup and operation current profiles

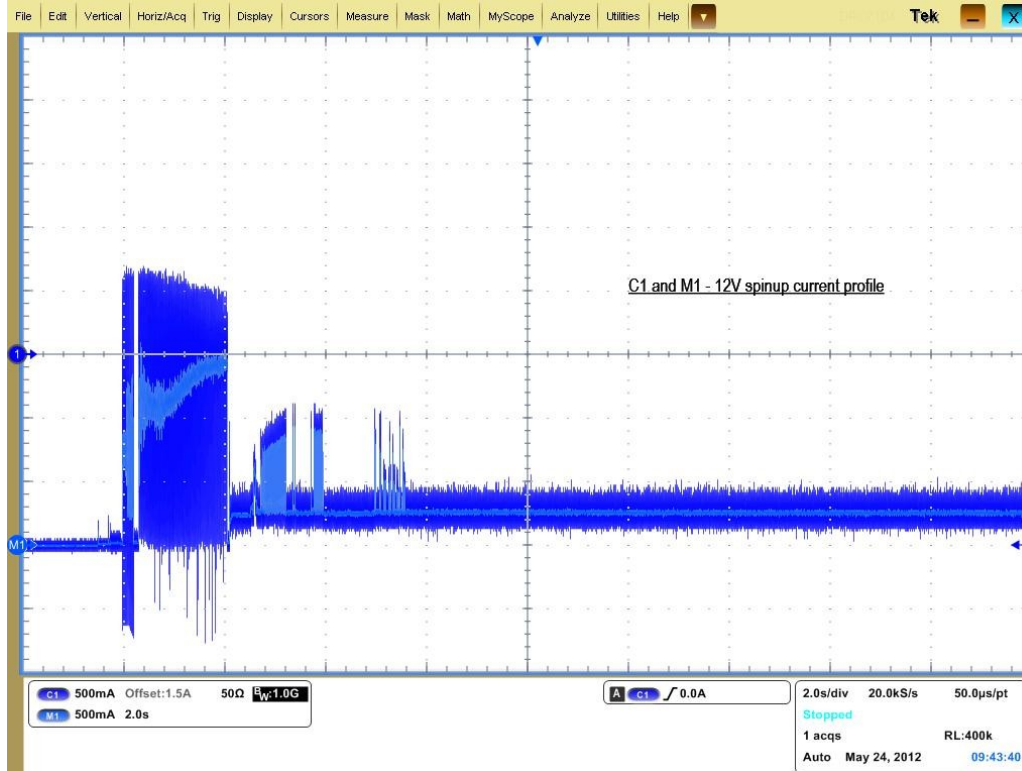

Figure 4 Typical 1TB model 12V - 6Gb/s startup and operation current profiles

2.8.2 Conducted noise

Input noise ripple is measured at the host system power supply across an equivalent 80-ohm resistive load on the +12 volt line or an equivalent 15-ohm resistive load on the +5 volt line.

- Using 12-volt power, the drive is expected to operate with a maximum of 120 mV peak-to-peak square-wave injected noise at up to 10MHz.
- Using 5-volt power, the drive is expected to operate with a maximum of 100 mV peak-to-peak square-wave injected noise at up to 10MHz.

Note	Equivalent resistance is calculated by dividing the nominal voltage by the typical RMS read/write current.
-------------	--

2.8.3 Voltage tolerance

Voltage tolerance (including noise):

- 5V \pm 5%
- 12V \pm 10%

2.8.4 Power-management modes

The drive provides programmable power management to provide greater energy efficiency. In most systems, you can control power management through the system setup program. The drive features the following power-management modes:

Power modes	Heads	Spindle	Buffer
Active	Tracking	Rotating	Enabled
Idle_a	ID Biased	Rotating	Enabled
Idle_b	Parked	Rotating	Enabled
Idle_c	Parked	Rotating at lower RPM	Enabled
Standby	Parked	Stopped	Enabled
Sleep	Parked	Stopped	Disabled

- Active mode
The drive is in Active mode during the read/write and seek operations.
- Idle mode
The buffer remains enabled, and the drive accepts all commands and returns to Active mode any time disk access is necessary.
- Standby mode
The drive enters Standby mode when the host sends a Standby Immediate command. If the host has set the standby timer, the drive can also enter Standby mode automatically after the drive has been inactive for a specifiable length of time. The standby timer delay is established using a Standby or Idle command. In Standby mode, the drive buffer is enabled, the heads are parked and the spindle is at rest. The drive accepts all commands and returns to Active mode any time disk access is necessary.
- Sleep mode
The drive enters Sleep mode after receiving a Sleep command from the host. In Sleep mode, the drive buffer is disabled, the heads are parked and the spindle is at rest. The drive leaves Sleep mode after it receives a Hard Reset or Soft Reset from the host. After receiving a reset, the drive exits Sleep mode and enters Standby mode with all current translation parameters intact.
- Idle and Standby timers
Each time the drive performs an Active function (read, write or seek), the standby timer is reinitialized and begins counting down from its specified delay times to zero. If the standby timer reaches zero before any drive activity is required, the drive makes a transition to Standby mode. In both Idle and Standby mode, the drive accepts all commands and returns to Active mode when disk access is necessary.

2.8.4.1 Extended Power Conditions - PowerChoice™

Utilizing the load/unload architecture a programmable power management interface is provided to tailor systems for reduced power consumption and performance requirements.

The table below lists the supported power conditions available in PowerChoice. Power conditions are ordered from highest power consumption (and shortest recovery time) to lowest power consumption (and longest recovery time) as follows: Idle_a power >= Idle_b power >= Idle_c power >= Standby_z power. The further you go down in the table, the more power savings is actualized. For example, Idle_b results in greater power savings than the Idle_a power condition. Standby results in the greatest power savings.

Power Condition Name	Power Condition ID	Description
Idle_a	81 _H	Reduced electronics
Idle_b	81 _H	Heads unloaded. Disks spinning at full RPM
Idle_c	81 _H	Heads unloaded. Disks spinning at reduced RPM
Standby_z	00 _H	Heads unloaded. Motor stopped (disks not spinning)

Each power condition has a set of current, saved and default settings. Default settings are not modifiable. Default and saved settings persist across power-on resets. The current settings do not persist across power-on resets. At the time of manufacture, the default, saved and current settings are in the Power Conditions log match.

PowerChoice is invoked using one of two methods

- Automatic power transitions which are triggered by expiration of individual power condition timers. These timer values may be customized and enabled using the Extended Power Conditions (EPC) feature set using the standardized Set Features command interface.
- Immediate host commanded power transitions may be initiated using an EPC Set Features "Go to Power Condition" subcommand to enter any supported power condition. Legacy power commands Standby Immediate and Idle Immediate also provide a method to directly transition the drive into supported power conditions.

PowerChoice exits power saving states under the following conditions

- Any command which requires the drive to enter the PM0: Active state (media access)
- Power on reset

PowerChoice provides the following reporting methods for tracking purposes

Check Power Mode Command

- Reports the current power state of the drive

Identify Device Command

- EPC Feature set supported flag
- EPC Feature enabled flag is set if at least one Idle power condition timer is enabled

Power Condition Log reports the following for each power condition

- Nominal recovery time from the power condition to active
- If the power condition is Supported, Changeable, and Savable
- Default enabled state, and timer value
- Saved enabled state, and timer value
- Current enabled state, and timer value

S.M.A.R.T. Read Data Reports

- Attribute 192 - Emergency Retract Count
- Attribute 193 - Load/Unload Cycle Count

PowerChoice Manufacture Default Power Condition Timer Values

Default power condition timer values have been established to assure product reliability and data integrity. A minimum timer value threshold of two minutes ensures the appropriate amount of background drive maintenance activities occur. Attempting to set a timer values less than the specified minimum timer value threshold will result in an aborted EPC "Set Power Condition Timer" subcommand.

Power Condition Name	Manufacturer Default Timer Values
Idle_a	2 min
Idle_b	4 min
Idle_c	10 min
Standby_z	15 min

Setting power condition timer values less than the manufacturer specified defaults or issuing the EPC "Go to Power Condition" subcommand at a rate exceeding the default timers may limit this products reliability and data integrity.

PowerChoice Supported Extended Power Condition Feature Subcommands

EPC Subcommands	Descriptions
00 _H	Restore Power Condition Settings
01 _H	Go to Power Condition
02 _H	Set Power Condition Timer
03 _H	Set Power Condition State

PowerChoice Supported Extended Power Condition Identifiers

Power Condition Identifiers	Power Condition Name
00 _H	Standby_z
01-80 _H	Reserved
81 _H	Idle_a
82 _H	Idle_b
83 _H	Idle_c
84-FE _H	Reserved
FF _H	All EPC Power Conditions

2.9 Environmental limits

Temperature and humidity values experienced by the drive must be such that condensation does not occur on any drive part. Altitude and atmospheric pressure specifications are referenced to a standard day at 58.7°F (14.8°C). Maximum wet bulb temperature is 82°F (28°C).

Note	The recommended storage period: <ul style="list-style-type: none"> • 1 year under controlled conditions of 34°C 90%RH or less • 90 days in uncontrolled storage conditions
-------------	--

2.9.1 Ambient temperature

a Operating

The drive meets the operating specifications over a 41°F to 140°F (5°C to 60°C) drive case temperature range with a maximum temperature gradient of 36°F (20°C) per hour.

The maximum allowable drive case temperature is 60°C. See [Figure 5](#) for HDA case temperature measurement location

The MTBF specification for the drive assumes the operating environment is designed to maintain nominal case temperature. The rated MTBF is based upon a sustained case temperature of 104°F (40°C). Occasional excursions in operating temperature between the rated MTBF temperature and the maximum drive operating case temperature may occur without impact to the rated MTBF temperature. However, continual or sustained operation at case temperatures beyond the rated MTBF temperature will degrade the drive MTBF and reduce product reliability.

Air flow may be required to achieve consistent nominal case temperature values (see [Section 3.4](#)). To confirm that the required cooling is provided for the electronics and HDA, place the drive in its final mechanical configuration, and perform random write/read operations. After the temperatures stabilize, measure the case temperature of the drive.

b Non-operating

–40° to 158°F (–40° to 70°C) package ambient with a maximum gradient of 36°F (20°C) per hour. This specification assumes that the drive is packaged in the shipping container designed by Seagate for use with drive.

Figure 5 Location of the HDA temperature check point

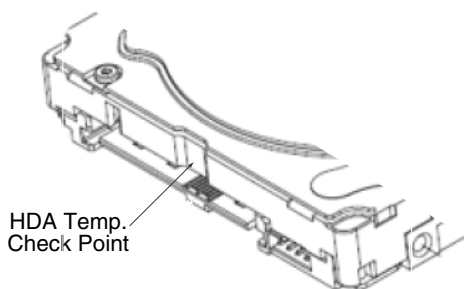

Note	Image is for reference only, may not represent actual drive
-------------	---

2.9.2 Humidity

2.9.2.1 Relative humidity

Operating	5% to 90% non-condensing (30% per hour max)
Nonoperating	5% to 95% non-condensing (30% per hour max)

2.9.3 Altitude

Operating	-304.80 m to 3048 m (-1000 ft. to 10,000+ ft.)
Non-operating	-304.80 m to 12,192 m (-1000 ft. to 40,000+ ft.)

2.9.4 Shock

All shock specifications assume that the drive is mounted securely with the input shock applied at the drive mounting screws. Shock may be applied in the X, Y or Z axis.

2.9.4.1 Operating shock

These drives comply with the performance levels specified in this document when subjected to a maximum operating shock of 70 Gs (read) and 40 Gs (write) based on half-sine shock pulses of 2 ms during read operations. Shocks should not be repeated more than two times per second.

2.9.4.2 Non-operating shock

3TB, 2TB and 1TB models

The non-operating shock level that the drive can experience without incurring physical damage or degradation in performance when subsequently put into operation is 300 Gs based on a non-repetitive half-sine shock pulse of 2 ms duration.

2.9.5 Vibration

All vibration specifications assume that the drive is mounted securely with the input vibration applied at the drive mounting screws. Vibration may be applied in the X, Y or Z axis.

2.9.5.1 Operating vibration

The maximum vibration levels that the drive may experience while meeting the performance standards specified in this document are specified below.

5Hz to 22Hz	0.25 Gs
22Hz to 350Hz	0.50 Gs
350Hz to 500Hz	0.25 Gs
20 - 1500Hz *(RROV)	12.5 rads/s ² w/RVFF

* Rotary Random Operating Vibration

All vibration specifications assume that the drive is mounted securely with the input vibration applied at the drive mounting screws. Vibration may be applied in the X, Y or Z axis. Throughput may vary if improperly mounted.

2.9.5.2 Non-operating vibration

The maximum non-operating vibration levels that the drive may experience without incurring physical damage or degradation in performance when subsequently put into operation are specified below.

10Hz to 500Hz Linear Random	4.9 Grms ref
--------------------------------	--------------

2.10 Acoustics

Drive acoustics are measured as overall A-weighted acoustic sound power levels (no pure tones). All measurements are consistent with ISO document 7779. Sound power measurements are taken under essentially free-field conditions over a reflecting plane. For all tests, the drive is oriented with the cover facing upward.

Note	For seek mode tests, the drive is placed in seek mode only. The number of seeks per second is defined by the following equation: (Number of seeks per second = $0.4 / (\text{average latency} + \text{average access time})$)
-------------	---

Table 3 Fluid Dynamic Bearing (FDB) motor acoustics

	Idle*	Performance Seek
3 Disks (3TB)	2.5 bels (typical) 2.6 bels (max)	2.5 bels (typical) 2.6 bels (max)
2 Disk (2TB)	2.4 bels (typical) 2.5 bels (max)	2.4 bels (typical) 2.5 bels (max)
1 Disk (1TB)	2.2 bels (typical) 2.3 bels (max)	2.2 bels (typical) 2.3 bels (max)

*During periods of drive idle, some offline activity may occur according to the S.M.A.R.T. specification, which may increase acoustic and power to operational levels.

2.11 Test for Prominent Discrete Tones (PDTs)

Seagate follows the ECMA-74 standards for measurement and identification of PDTs. An exception to this process is the use of the absolute threshold of hearing. Seagate uses this threshold curve (originated in ISO 389-7) to discern tone audibility and to compensate for the inaudible components of sound prior to computation of tone ratios according to Annex D of the ECMA-74 standards.

2.12 Electromagnetic immunity

When properly installed in a representative host system, the drive operates without errors or degradation in performance when subjected to the radio frequency (RF) environments defined in [Table 4](#).

Table 4 Radio frequency environments

Test	Description	Performance level	Reference standard
Electrostatic discharge	Contact, HCP, VCP: ± 4 kV; Air: ± 8 kV	B	EN61000-4-2: 95
Radiated RF immunity	80MHz to 1,000MHz, 3 V/m, 80% AM with 1kHz sine 900MHz, 3 V/m, 50% pulse modulation @ 200Hz	A	EN61000-4-3: 96 ENV50204: 95
Electrical fast transient	± 1 kV on AC mains, ± 0.5 kV on external I/O	B	EN61000-4-4: 95
Surge immunity	± 1 kV differential, ± 2 kV common, AC mains	B	EN61000-4-5: 95
Conducted RF immunity	150kHz to 80MHz, 3 Vrms, 80% AM with 1kHz sine	A	EN61000-4-6: 97
Voltage dips, interrupts	0% open, 5 seconds 0% short, 5 seconds 40%, 0.10 seconds 70%, 0.01 seconds	C C C B	EN61000-4-11: 94

2.13 Reliability

2.13.1 Annualized Failure Rate (AFR) and Mean Time Between Failures (MTBF)

The product shall achieve an Annualized Failure Rate (AFR) of 1.1% (MTBF of 800 thousand hours) when operated at nominal power and typical case temperatures of 40°C. Operation at temperatures outside the specifications in Section 2.9 may increase the product AFR (decrease MTBF). AFR and MTBF are population statistics that are not relevant to individual units.

AFR and MTBF specifications are based on the following assumptions for business critical storage system environments:

- 8760 power-on-hours per year.
- Operations at nominal voltages.
- Temperatures outside the specifications in Section 2.9 may reduce the product reliability.
- A workload rate below the average annualized specified limits. Operation at excessive I/O duty cycle may degrade product reliability.

The enterprise application nearline environment of power-on-hours, temperature, and I/O duty cycle affect the product AFR and MTBF.

Nonrecoverable read errors	1 per 10 ¹⁴ bits read, max
Annualized Failure Rate (AFR)	1.1% (nominal power, 40°C case temperature)
Load/unload cycles	300,000 cycles
Rated Workload	Average rate of <180TB/year The MTBF specification for the drive assumes the I/O workload does not exceed the Average Annualized Workload Rate Limit of <180TB/year. Workloads exceeding the annualized rate may degrade the drive MTBF and impact product reliability. The Average Annualized Workload Rate Limit is in units of TB per year, or TB per 8760 power on hours. Workload Rate = TB transferred x (8760 / recorded power on hours).
Warranty	To determine the warranty for a specific drive, use a web browser to access the following web page: http://www.seagate.com/support/warranty-and-returns/ From this page, click on the "Verify Your Warranty" link. You will be asked to provide the drive serial number, model number (or part number) and country of purchase. The system will display the warranty information for your drive.
Preventive maintenance	None required.

2.14 Agency certification

2.14.1 Safety certification

These products are certified to meet the requirements of UL60950-1, CSA60950-1 and EN60950 and so marked as to the certify agency.

2.14.2 Electromagnetic compatibility

Hard drives that display the CE mark comply with the European Union (EU) requirements specified in the Electromagnetic Compatibility Directive (2004/108/EC) as put into place 20 July 2007. Testing is performed to the levels specified by the product standards for Information Technology Equipment (ITE). Emission levels are defined by EN 55022, Class B and the immunity levels are defined by EN 55024.

Drives are tested in representative end-user systems. Although CE-marked Seagate drives comply with the directives when used in the test systems, we cannot guarantee that all systems will comply with the directives. The drive is designed for operation inside a properly designed enclosure, with properly shielded I/O cable (if necessary) and terminators on all unused I/O ports. Computer manufacturers and system integrators should confirm EMC compliance and provide CE marking for their products.

Korean RRL

If these drives have the Korean Communications Commission (KCC) logo, they comply with paragraph 1 of Article 11 of the Electromagnetic Compatibility control Regulation and meet the Electromagnetic Compatibility (EMC) Framework requirements of the Radio Research Laboratory (RRL) Communications Commission, Republic of Korea.

These drives have been tested and comply with the Electromagnetic Interference/Electromagnetic Susceptibility (EMI/EMS) for Class B products. Drives are tested in a representative, end-user system by a Korean-recognized lab.

- Family name: Constellation CS
- Certificate number: STX-Constell-ES
- Date of certification: Aug. 20, 2009

Australian C-Tick (N176)

If these models have the C-Tick marking, they comply with the Australia/New Zealand Standard AS/NZ CISPR22 and meet the Electromagnetic Compatibility (EMC) Framework requirements of the Australian Communication Authority (ACA).

2.14.3 FCC verification

These drives are intended to be contained solely within a personal computer or similar enclosure (not attached as an external device). As such, each drive is considered to be a subassembly even when it is individually marketed to the customer. As a subassembly, no Federal Communications Commission verification or certification of the device is required.

Seagate has tested this device in enclosures as described above to ensure that the total assembly (enclosure, disk drive, motherboard, power supply, etc.) does comply with the limits for a Class B computing device, pursuant to Subpart J, Part 15 of the FCC rules. Operation with non-certified assemblies is likely to result in interference to radio and television reception.

Radio and television interference. This equipment generates and uses radio frequency energy and if not installed and used in strict accordance with the manufacturer's instructions, may cause interference to radio and television reception.

This equipment is designed to provide reasonable protection against such interference in a residential installation. However, there is no guarantee that interference will not occur in a particular installation. If this equipment does cause interference to radio or television, which can be determined by turning the equipment on and off, you are encouraged to try one or more of the following corrective measures:

- Reorient the receiving antenna.
- Move the device to one side or the other of the radio or TV.
- Move the device farther away from the radio or TV.
- Plug the computer into a different outlet so that the receiver and computer are on different branch outlets.

If necessary, you should consult your dealer or an experienced radio/television technician for additional suggestions. You may find helpful the following booklet prepared by the Federal Communications Commission: *How to Identify and Resolve Radio-Television Interference Problems*. This booklet is available from the Superintendent of Documents, U.S. Government Printing Office, Washington, DC 20402. Refer to publication number 004-000-00345-4.

2.15 Environmental protection

Seagate designs its products to meet environmental protection requirements worldwide, including regulations restricting certain chemical substances.

2.15.1 European Union Restriction of Hazardous Substances (RoHS) Directive

The European Union Restriction of Hazardous Substances (RoHS) Directive, restricts the presence of chemical substances, including Lead, Cadmium, Mercury, Hexavalent Chromium, PBB and PBDE, in electronic products, effective July 2006. This drive is manufactured with components and materials that comply with the RoHS Directive.

2.15.2 China Restriction of Hazardous Substances (RoHS) Directive 中国限制危险物品的指令

This product has an Environmental Protection Use Period (EPUP) of 20 years. The following table contains information mandated by China's "Marking Requirements for Control of Pollution Caused by Electronic Information Products" Standard.



该产品具有20年的环境保护使用周期（EPUP）。下表包含了中国“电子产品所导致的污染的控制的记号要求”所指定的信息。

Name of Parts 部件名称	Toxic or Hazardous Substances or Elements有毒有害物质或元素					
	Lead 铅 (Pb)	Mercury 汞 (Hg)	Cadmium 镉 (Cd)	Hexavalent Chromium 六价铬 (Cr6+)	Polybrominated Diphenyl 多溴联苯 (PBB)	Polybrominated Diphenyl Ether 多溴二苯醚 (PBDE)
PCBA	X	O	O	O	O	O
HDA	X	O	O	O	O	O

"O" indicates the hazardous and toxic substance content of the part (at the homogenous material level) is lower than the threshold defined by the China RoHS MCV Standard.

“O”表示该部件（于同类物品程度上）所含的危险和有毒物质低于中国RoHS MCV标准所定义的门槛值。

"X" indicates the hazardous and toxic substance content of the part (at the homogenous material level) is over the threshold defined by the China RoHS MCV Standard.

“X”表示该部件（于同类物品程度上）所含的危险和有毒物质超出中国RoHS MCV标准所定义的门槛值。

2.16 Corrosive environment

Seagate electronic drive components pass accelerated corrosion testing equivalent to 10 years exposure to light industrial environments containing sulfurous gases, chlorine and nitric oxide, classes G and H per ASTM B845. However, this accelerated testing cannot duplicate every potential application environment. Users should use caution exposing any electronic components to uncontrolled chemical pollutants and corrosive chemicals as electronic drive component reliability can be affected by the installation environment. The silver, copper, nickel and gold films used in Seagate products are especially sensitive to the presence of sulfide, chloride, and nitrate contaminants. Sulfur is found to be the most damaging. In addition, electronic components should never be exposed to condensing water on the surface of the printed circuit board assembly (PCBA) or exposed to an ambient relative humidity greater than 95%. Materials used in cabinet fabrication, such as vulcanized rubber, that can outgas corrosive compounds should be minimized or eliminated. The useful life of any electronic equipment may be extended by replacing materials near circuitry with sulfide-free alternatives.

2.17 Product warranty

Beginning on the date of shipment to the customer and continuing for the period specified in your purchase contract, Seagate warrants that each product (including components and subassemblies) that fails to function properly under normal use due to defect in materials or workmanship or due to nonconformance to the applicable specifications will be repaired or replaced, at Seagate's option and at no charge to the customer, if returned by customer at customer's expense to Seagate's designated

facility in accordance with Seagate's warranty procedure. Seagate will pay for transporting the repair or replacement item to the customer. For more detailed warranty information, refer to the standard terms and conditions of purchase for Seagate products on your purchase documentation.

The remaining warranty for a particular drive can be determined by calling Seagate Customer Service at 1-800-468-3472. You can also determine remaining warranty using the Seagate web site (www.seagate.com). The drive serial number is required to determine remaining warranty information.

Shipping

When transporting or shipping a drive, use only a Seagate-approved container. Keep your original box. Seagate approved containers are easily identified by the Seagate Approved Package label. Shipping a drive in a non-approved container voids the drive warranty.

Seagate repair centers may refuse receipt of components improperly packaged or obviously damaged in transit. Contact your authorized Seagate distributor to purchase additional boxes. Seagate recommends shipping by an air-ride carrier experienced in handling computer equipment.

Storage

The maximum recommended storage period for the drive in a non-operational environment is 90 days. Drives should be stored in the original unopened Seagate shipping packaging whenever possible. Once the drive is removed from the Seagate original packaging the recommended maximum period between drive operation cycles is 30 days. During any storage period the drive non-operational temperature, humidity, wet bulb, atmospheric conditions, shock, vibration, magnetic and electrical field specifications should be followed.

Product repair and return information

Seagate customer service centers are the only facilities authorized to service Seagate drives. Seagate does not sanction any third-party repair facilities. Any unauthorized repair or tampering with the factory seal voids the warranty.

3.0 Configuring and Mounting the Drive

This section contains the specifications and instructions for configuring and mounting the drive.

3.1 Handling and static-discharge precautions

After unpacking, and before installation, the drive may be exposed to potential handling and electrostatic discharge (ESD) hazards. Observe the following standard handling and static-discharge precautions:

Caution	<ul style="list-style-type: none"> • Before handling the drive, put on a grounded wrist strap, or ground yourself frequently by touching the metal chassis of a computer that is plugged into a grounded outlet. Wear a grounded wrist strap throughout the entire installation procedure. • Handle the drive by its edges or frame <i>only</i>. • The drive is extremely fragile—handle it with care. Do not press down on the drive top cover. • Always rest the drive on a padded, antistatic surface until you mount it in the computer. • Do not touch the connector pins or the printed circuit board. • Do not remove the factory-installed labels from the drive or cover them with additional labels. Removal voids the warranty. Some factory-installed labels contain information needed to service the drive. Other labels are used to seal out dirt and contamination.
----------------	---

3.2 Configuring the drive

Each drive on the SATA interface connects point-to-point with the SATA host adapter. There is no master/slave relationship because each drive is considered a master in a point-to-point relationship. If two drives are attached on one SATA host adapter, the host operating system views the two devices as if they were both “masters” on two separate ports. Both drives behave as if they are Device 0 (master) devices.

3.3 SATA cables and connectors

The SATA interface cable consists of four conductors in two differential pairs, plus three ground connections. The cable size may be 30 to 26 AWG with a maximum length of one meter (39.37 inches). See [Table 5](#) for connector pin definitions. Either end of the SATA signal cable can be attached to the drive or host.

For direct backplane connection, the drive connectors are inserted directly into the host receptacle. The drive and the host receptacle incorporate features that enable the direct connection to be hot pluggable and blind mateable.

For installations which require cables, you can connect the drive as illustrated in [Figure 6](#).

Figure 6 Attaching SATA cabling

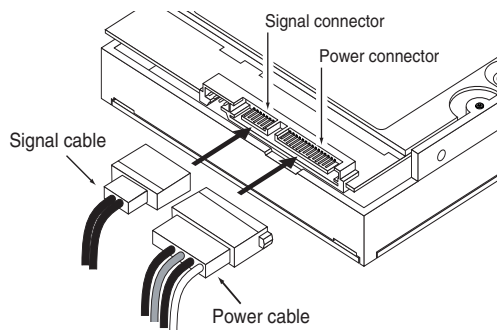

Each cable is keyed to ensure correct orientation. Constellation CS Serial ATA drives support latching SATA connectors.

3.4 Drive mounting

You can mount the drive in any orientation using four screws in the side-mounting holes or four screws in the bottom-mounting holes. Refer to **Figure 7** for drive mounting dimensions. Follow these important mounting precautions when mounting the drive:

- Allow a minimum clearance of 0.030 inches (0.76mm) around the entire perimeter of the drive for cooling.
- Use only 6-32 UNC mounting screws.
- The screws should be inserted no more than 0.150 inch (3.81mm) into the bottom or side mounting holes.
- Do not overtighten the mounting screws (maximum torque: 6 inch-lb).

Weight: (maximum)	3TB models	2TB models	1TB models
	626g (1.38 lb)	535g (1.18 lb)	400g (0.88 lb)

Note These dimensions conform to the Small Form Factor Standard documented in SFF-8301 and SFF-8323 found at www.sffcommittee.org

Figure 7 Mounting dimensions

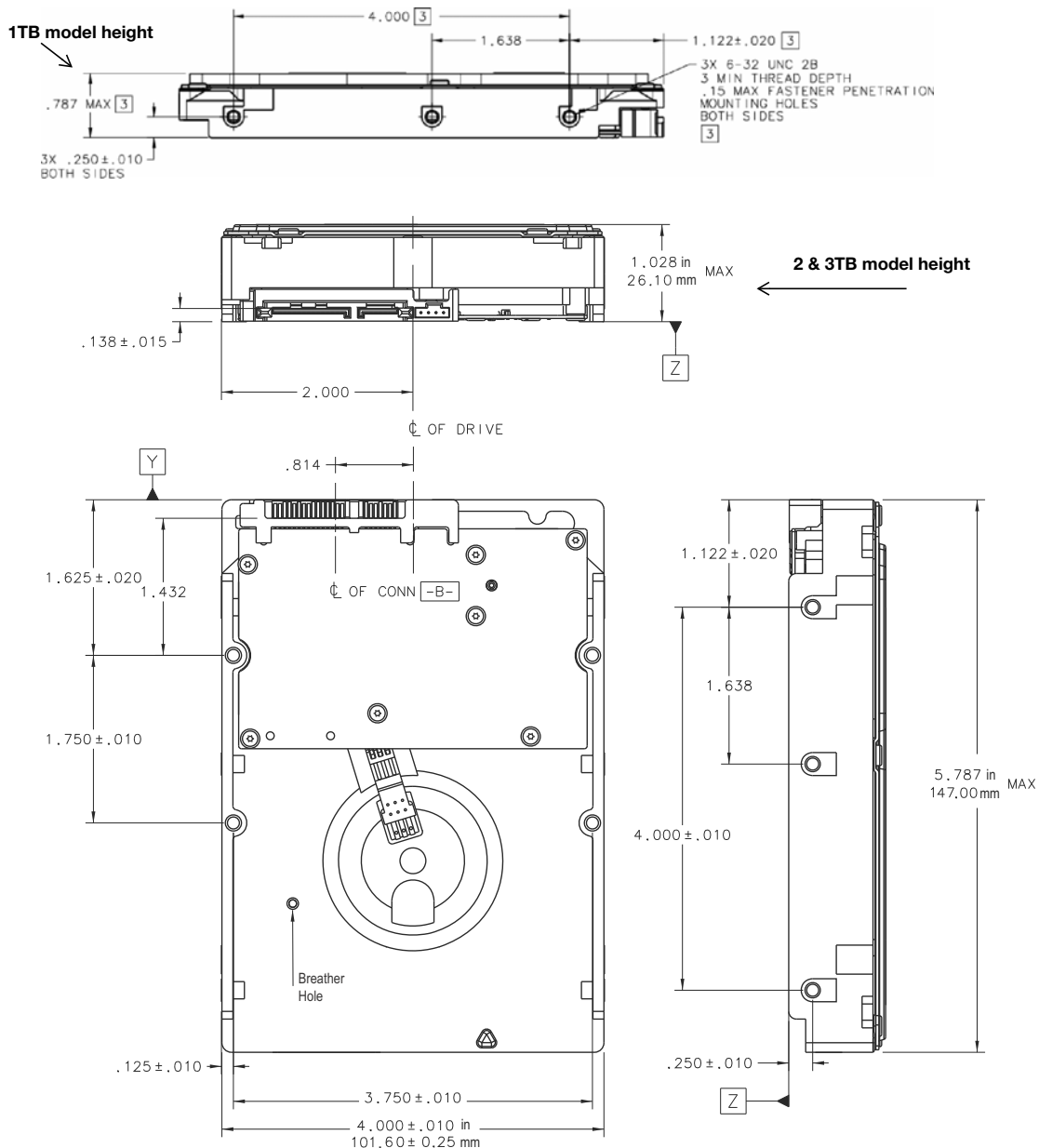

4.0 About Seagate Instant Secure Erase drives

Self-encrypting drives (SEDs) offer encryption and security services for the protection of stored data, commonly known as “protection of data at rest”.

4.1 Data encryption

Encrypting drives use one inline encryption engine for each port, employing AES-256 data encryption in Cipher Block Chaining (CBC) mode to encrypt all data prior to being written on the media and to decrypt all data as it is read from the media. The encryption engines are always in operation, cannot be disabled, and do not detract in any way from the performance of the drive.

The 32-byte Data Encryption Key (DEK) is a random number which is generated by the drive, never leaves the drive, and is inaccessible to the host system. The DEK is itself encrypted when it is stored on the media and when it is in volatile temporary storage (DRAM) external to the encryption engine. A unique data encryption key is used for each of the drive's possible 16 data bands (see Section 6.5).

4.2 Cryptographic erase

A significant feature of SEDs is the ability to perform a cryptographic erase. This involves the host telling the drive to change the data encryption key for a particular band. Once changed, the data is no longer recoverable since it was written with one key and will be read using a different key. Since the drive overwrites the old key with the new one, and keeps no history of key changes, the user data can never be recovered. This is tantamount to an instantaneous data erase and is very useful if the drive is to be scrapped or redispositioned.

4.3 Power requirements

The standard drive models and the SED drive models have identical hardware, however the security and encryption portion of the drive controller ASIC is enabled and functional in the SED models. This represents a small additional drain on the 5V supply of about 30mA and a commensurate increase of about 150mW in power consumption. There is no additional drain on the 12V supply. See the tables in Section 4.3 for power requirements on the standard (non-SED) drive models.

4.4 RevertSP

The SED models will support RevertSP feature where it erases all data in all bands on the device and returns the contents of all SPs (Security Providers) on the device to their Original Factory State.

4.5 ATA Security Erase Unit Command on SED SATA drives

The ATA SECURITY ERASE UNIT command shall support both the Normal and Enhanced erase modes with the following modifications/additions:

- Normal Erase: Normal erase shall be accomplished by changing the media encryption key for the drive followed by an overwrite operation that repeatedly writes a single sector containing random data to the entire drive. The write operation shall bypass the media encryption. On reading back the overwritten sectors, the host will receive a decrypted version, using the new encryption key, of the random data sector (the returned data will not match what was written).
- Enhanced Erase: Enhanced erase shall be accomplished by changing the media encryption key for the drive.

4.6 Sanitize Feature Set on SED Drives

The drive shall support the Sanitize Feature Set as defined in ANSI/INCITS ACS-2 with the exceptions and/or modifications described in this section.

The drive shall not support the OVERWRITE EXT and BLOCK ERASE EXT sub-commands.

Support of the SANITIZE FREEZE LOCK EXT command shall be determined on a customer-specific basis. OEM drives shall support the command.

5.0 SATA Interface

These drives use the industry-standard Serial ATA (SATA) interface that supports FIS data transfers. It supports ATA programmed input/output (PIO) modes 0 to 4; multiword DMA modes 0 to 2, and Ultra DMA modes 0 to 6.

For detailed information about the SATA interface, refer to the “Serial ATA: High Speed Serialized AT Attachment” specification.

5.1 Hot-Plug compatibility

Constellation CS Serial ATA drives incorporate connectors which enable you to hot plug these drives in accordance with the SATA Revision 3.0 specification. This specification can be downloaded from www.serialata.org.

Caution	The drive motor must come to a complete stop (Ready to spindle stop time indicated in Section 3.7) prior to changing the plane of operation. This time is required to insure data integrity.
----------------	--

5.2 SATA device plug connector pin definitions

Table 5 summarizes the signals on the SATA interface and power connectors.

Table 5 SATA connector pin definitions

Segment	Pin	Function	Definition
Signal	S1	Ground	2nd mate
	S2	A+	Differential signal pair A from Phy
	S3	A-	
	S4	Ground	2nd mate
	S5	B-	Differential signal pair B from Phy
	S6	B+	
	S7	Ground	2nd mate
Key and spacing separate signal and power segments			
Power	P1	V ₃₃	3.3V power
	P2	V ₃₃	3.3V power
	P3	V ₃₃	3.3V power, pre-charge, 2nd mate
	P4	Ground	1st mate
	P5	Ground	2nd mate
	P6	Ground	2nd mate
	P7	V ₅	5V power, pre-charge, 2nd mate
	P8	V ₅	5V power
	P9	V ₅	5V power
	P10	Ground	2nd mate
	P11	Ground or LED signal	If grounded, drive does not use deferred spin
	P12	Ground	1st mate.
	P13	V ₁₂	12V power, pre-charge, 2nd mate
	P14	V ₁₂	12V power
	P15	V ₁₂	12V power

Notes

- All pins are in a single row, with a 1.27 mm (0.050") pitch.
- The comments on the mating sequence apply to the case of backplane blindmate connector only. In this case, the mating sequences are:
 - the ground pins P4 and P12.
 - the pre-charge power pins and the other ground pins.
 - the signal pins and the rest of the power pins.
- There are three power pins for each voltage. One pin from each voltage is used for pre-charge when installed in a blind-mate backplane configuration.
 - All used voltage pins (V_x) must be terminated.

5.3 Supported ATA commands

The following table lists SATA standard commands that the drive supports.

For a detailed description of the ATA commands, refer to the Serial ATA International Organization: Serial ATA Revision 3.0 (<http://www.sata-io.org>).

See “S.M.A.R.T. commands” on page 34 for details and subcommands used in the S.M.A.R.T. implementation.

Command name	Command code (in hex)
Check Power Mode	E5 _H
Download Microcode	92 _H
Execute Device Diagnostics	90 _H
Flush Cache	E7 _H
Flush Cache Extended	EA _H
Identify Device	EC _H
Idle	E3 _H
Idle Immediate	E1 _H
NOP	00 _H
Read Buffer	E4 _H
Read Buffer DMA	E9 _H
Read DMA	C8 _H
Read DMA Extended	25 _H
Read FPDMA Queued	60 _H
Read Log Ext	2F _H
Read Log DMA Ext	47 _H
Read Multiple	C4 _H
Read Multiple Extended	29 _H
Read Native Max Address	F8 _H
Read Native Max Address Extended	27 _H
Read Sectors	20 _H
Read Sectors Extended	24 _H
Read Sectors Without Retries	21 _H
Read Verify Sectors	40 _H
Read Verify Sectors Extended	42 _H
Read Verify Sectors Without Retries	41 _H
Request Sense Data Ext	0B _H
Sanitize Device - Status Ext	B4 _H / 0000 _H
Sanitize Device - Crypto Scramble Ext	B4 _H / 0011 _H
Sanitize Device - Freeze Lock Ext	B4 _H / 0020 _H
Security Disable Password	F6 _H
Security Erase Prepare	F3 _H
Security Erase Unit	F4 _H
Security Freeze Lock	F5 _H

Command name	Command code (in hex)	
Security Set Password	F1 _H	
Security Unlock	F2 _H	
Seek	70 _H	
Set Features	EF _H	
Set Max Address	F9 _H	
Note: Individual Set Max Address commands are identified by the value placed in the Set Max Features register as defined to the right.	Address:	00 _H
	Password:	01 _H
	Lock:	02 _H
	Unlock:	03 _H
	Freeze Lock:	04 _H
Set Max Address Extended	37 _H	
Set Multiple Mode	C6 _H	
Sleep	E6 _H	
S.M.A.R.T. Disable Operations	B0 _H / D9 _H	
S.M.A.R.T. Enable/Disable Autosave	B0 _H / D2 _H	
S.M.A.R.T. Enable Operations	B0 _H / D8 _H	
S.M.A.R.T. Execute Offline	B0 _H / D4 _H	
S.M.A.R.T. Read Attribute Thresholds	B0 _H / D1 _H	
S.M.A.R.T. Read Data	B0 _H / D0 _H	
S.M.A.R.T. Read Log Sector	B0 _H / D5 _H	
S.M.A.R.T. Return Status	B0 _H / DA _H	
S.M.A.R.T. Save Attribute Values	B0 _H / D3 _H	
S.M.A.R.T. Write Log Sector	B0 _H / D6 _H	
Standby	E2 _H	
Standby Immediate	E0 _H	
Write Buffer	E8 _H	
Write Buffer DMA	EB _H	
Write DMA	CA _H	
Write DMA Extended	35 _H	
Write DMA FUA Extended	3D _H	
Write FPDMA Queued	61 _H	
Write Log Extended	3F _H	
Write Log DMA Ext	57 _H	
Write Multiple	C5 _H	
Write Multiple Extended	39 _H	
Write Multiple FUA Extended	CE _H	
Write Sectors	30 _H	
Write Sectors Without Retries	31 _H	
Write Sectors Extended	34 _H	
Write Uncorrectable	45 _H	

5.3.1 Identify Device command

The Identify Device command (command code EC_H) transfers information about the drive to the host following power up. The data is organized as a single 512-byte block of data, whose contents are shown on page 28. All reserved bits or words should be set to zero. Parameters listed with an “x” are drive-specific or vary with the state of the drive.

The following commands contain drive-specific features that may not be included in the SATA specification.

Word	Description	Value
0	Configuration information: Bit 15: 0 = ATA; 1 = ATAPI • Bit 7: removable media • Bit 6: removable controller • Bit 0: reserved	0C5A _H
1	Number of logical cylinders	16,383
2	ATA-reserved	0000 _H
3	Number of logical heads	16
4	Retired	0000 _H
5	Retired	0000 _H
6	Number of logical sectors per logical track: 63	003F _H
7–9	Retired	0000 _H
10–19	Serial number: (20 ASCII characters, 0000 _H = none)	ASCII
20	Retired	0000 _H
21	Retired	0000 _H
22	Obsolete	0000 _H
23–26	Firmware revision (8 ASCII character string, padded with blanks to end of string)	xxxx
27–46	Drive model number: (40 ASCII characters, padded with blanks to end of string)	
47	(Bits 7–0) Maximum sectors per interrupt on Read multiple and Write multiple (16)	8010 _H
48	Reserved	0000 _H
49	Standard Standby timer, IORDY supported and may be disabled	2F00 _H
50	ATA-reserved	0000 _H
51	PIO data-transfer cycle timing mode	0200 _H
52	Retired	0200 _H
53	Words 54–58, 64–70 and 88 are valid	0007 _H
54	Number of current logical cylinders	xxxx _H
55	Number of current logical heads	xxxx _H
56	Number of current logical sectors per logical track	xxxx _H
57–58	Current capacity in sectors	xxxx _H
59	Number of sectors transferred during a Read Multiple or Write Multiple command	xxxx _H
60–61	Total number of user-addressable LBA sectors available (see Section 2.2 for related information) *Note: The maximum value allowed in this field is: 0FFFFFFFh (268,435,455 sectors, 137GB). Drives with capacities over 137GB will have 0FFFFFFFh in this field and the actual number of user-addressable LBAs specified in words 100-103. This is required for drives that support the 48-bit addressing feature.	0FFFFFFFh*
62	Retired	0000 _H
63	Multiword DMA active and modes supported (see note following this table)	xx07 _H
64	Advanced PIO modes supported (modes 3 and 4 supported)	0003 _H
65	Minimum multiword DMA transfer cycle time per word (120 nsec)	0078 _H
66	Recommended multiword DMA transfer cycle time per word (120 nsec)	0078 _H
67	Minimum PIO cycle time without IORDY flow control (240 nsec)	0078 _H

Word	Description	Value
68	Minimum PIO cycle time with IORDY flow control (120 nsec)	0078 _H
69–74	ATA-reserved	0000 _H
75	Queue depth	001F _H
76	SATA capabilities	xxxx _H
77	Reserved for future SATA definition	xxxx _H
78	SATA features supported	xxxx _H
79	SATA features enabled	xxxx _H
80	Major version number	01F0 _H
81	Minor version number	0029 _H
82	Command sets supported	346B _H
83	Command sets supported	7501 _H
84	Command sets support extension (see note following this table)	4163 _H See Word 108-111 note. (4163H = 0100000101100011 binary)
85	Command sets enabled	3469 _H
86	Command sets enabled	B401 _H
87	Command sets enable extension	4163 _H
88	Ultra DMA support and current mode (see note following this table)	xx7F _H
89	Security erase time	009C _H
90	Enhanced security erase time	009C _H
92	Master password revision code	FFFE _H
93	Hardware reset value	0000 _H
95–99	ATA-reserved	0000 _H
100–103	Total number of user-addressable LBA sectors available (see Section 2.2 for related information). These words are required for drives that support the 48-bit addressing feature. Maximum value: 0000FFFFFFFFFh.	ST3000NC002 = 5,860,533,168 ST3000NC000 = 5,860,533,168 ST2000NC001 = 3,907,029,168 ST2000NC000 = 3,907,029,168 ST1000NC001 = 1,953,525,168 ST1000NC000 = 1,953,525,168
104–107	ATA-reserved	0000 _H
108–111	The mandatory value of the world wide name (WWN) for the drive. NOTE: This field is valid if word 84, bit 8 is set to 1 indicating 64-bit WWN support.	Each drive will have a unique value.
112–127	ATA-reserved	0000 _H
128	Security status	0021 _H
129–159	Seagate-reserved	xxxx _H
160–254	ATA-reserved	0000 _H
255	Integrity word	xxA5 _H

Note

See the bit descriptions below for words 63, 84, and 88 of the Identify Drive data.

Description (if bit is set to 1)		
Bit	Word 63	
0	Multiword DMA mode 0 is supported.	
1	Multiword DMA mode 1 is supported.	
2	Multiword DMA mode 2 is supported.	
8	Multiword DMA mode 0 is currently active.	
9	Multiword DMA mode 1 is currently active.	
10	Multiword DMA mode 2 is currently active.	

	Bit	Word 84
	0	SMART error login is supported.
	1	SMART self-test is supported.
	2	Media serial number is supported.
	3	Media Card Pass Through Command feature set is supported.
	4	Streaming feature set is supported.
	5	GPL feature set is supported.
	6	WRITE DMA FUA EXT and WRITE MULTIPLE FUA EXT commands are supported.
	7	WRITE DMA QUEUED FUA EXT command is supported.
	8	64-bit World Wide Name is supported.
	9-10	Obsolete.
	11-12	Reserved for TLC.
	13	IDLE IMMEDIATE command with IUNLOAD feature is supported.
	14	Shall be set to 1.
	15	Shall be cleared to 0.
	Bit	Word 88
	0	Ultra DMA mode 0 is supported.
	1	Ultra DMA mode 1 is supported.
	2	Ultra DMA mode 2 is supported.
	3	Ultra DMA mode 3 is supported.
	4	Ultra DMA mode 4 is supported.
	5	Ultra DMA mode 5 is supported.
	6	Ultra DMA mode 6 is supported.
	8	Ultra DMA mode 0 is currently active.
	9	Ultra DMA mode 1 is currently active.
	10	Ultra DMA mode 2 is currently active.
	11	Ultra DMA mode 3 is currently active.
	12	Ultra DMA mode 4 is currently active.
	13	Ultra DMA mode 5 is currently active.
	14	Ultra DMA mode 6 is currently active.

5.3.2 Set Features command

This command controls the implementation of various features that the drive supports. When the drive receives this command, it sets BSY, checks the contents of the Features register, clears BSY and generates an interrupt. If the value in the register does not represent a feature that the drive supports, the command is aborted. Power-on default has the read look-ahead and write caching features enabled. The acceptable values for the Features register are defined as follows:

02 _H	Enable write cache (<i>default</i>).
03 _H	Set transfer mode (based on value in Sector Count register). Sector Count register values:
	00 _H Set PIO mode to default (PIO mode 2).
	01 _H Set PIO mode to default and disable IORDY (PIO mode 2).
	08 _H PIO mode 0
	09 _H PIO mode 1
	0A _H PIO mode 2
	0B _H PIO mode 3
	0C _H PIO mode 4 (<i>default</i>)
	20 _H Multiword DMA mode 0
	21 _H Multiword DMA mode 1
	22 _H Multiword DMA mode 2
	40 _H Ultra DMA mode 0
	41 _H Ultra DMA mode 1
	42 _H Ultra DMA mode 2
	43 _H Ultra DMA mode 3
	44 _H Ultra DMA mode 4
	45 _H Ultra DMA mode 5
	46 _H Ultra DMA mode 6
10 _H	Enable use of SATA features
55 _H	Disable read look-ahead (read cache) feature.
82 _H	Disable write cache
90 _H	Disable use of SATA features
AA _H	Enable read look-ahead (read cache) feature (<i>default</i>).
F1 _H	Report full capacity available

Note

At power-on, or after a hardware or software reset, the default values of the features are as indicated above.

5.3.3 S.M.A.R.T. commands

S.M.A.R.T. provides near-term failure prediction for disk drives. When S.M.A.R.T. is enabled, the drive monitors predetermined drive attributes that are susceptible to degradation over time. If self-monitoring determines that a failure is likely, S.M.A.R.T. makes a status report available to the host. Not all failures are predictable. S.M.A.R.T. predictability is limited to the attributes the drive can monitor. For more information on S.M.A.R.T. commands and implementation, see the *Draft ATA-5 Standard*.

SeaTools diagnostic software activates a built-in drive self-test (DST S.M.A.R.T. command for D4H) that eliminates unnecessary drive returns. The diagnostic software ships with all new drives and is also available at:

<http://www.seagate.com/support/downloads/seatools/>.

This drive is shipped with S.M.A.R.T. features disabled. You must have a recent BIOS or software package that supports S.M.A.R.T. to enable this feature. The table below shows the S.M.A.R.T. command codes that the drive uses.

Code in features register	S.M.A.R.T. command
D0 _H	S.M.A.R.T. Read Data
D2 _H	S.M.A.R.T. Enable/Disable Attribute Autosave
D3 _H	S.M.A.R.T. Save Attribute Values
D4 _H	S.M.A.R.T. Execute Off-line Immediate (runs DST)
D5 _H	S.M.A.R.T. Read Log Sector
D6 _H	S.M.A.R.T. Write Log Sector
D8 _H	S.M.A.R.T. Enable Operations
D9 _H	S.M.A.R.T. Disable Operations
DA _H	S.M.A.R.T. Return Status

Note	If an appropriate code is not written to the Features Register, the command is aborted and 0x04 (abort) is written to the Error register.
-------------	---

A

ACA 20
 acoustics 18
 Active 13
 Active mode 13
 actuator arm 7
 AES-256 25
 Agency certification 19
 altitude 17
 ambient 16
 Ambient temperature 16
 ambient temperature 7
 Annualized Failure Rate 19
 Annualized Failure Rate (AFR) 19
 areal density 6
 ATA commands 28
 Australia/New Zealand Standard AS/NZ CISPR22 20
 Australian Communication Authority (ACA) 20
 Australian C-Tick 20
 average idle current 8
 Average latency 7
 Average seek time 7

B

BPI 6
 buffer 6

C

cables and connectors 23
 cache 6
 capacity 5
 CBC 25
 CE mark 19
 certification 19
 Check Power Mode 28
 China RoHS directive 21
 Cipher Block Chaining 25
 compatibility 19
 Conducted noise 12
 Conducted RF immunity 18
 Configuring the drive 23
 connectors 23
 Corrosive environment 21
 Cryptographic erase 25
 CSA60950-1 19

D

data bands 25
 Data encryption 25
 Data Encryption Key 25
 DC power 7
 decrypt 25
 Default logical geometry 6
 DEK 25
 density 6
 dimensions 24
 disc surface 7
 Download Microcode 28

E

Electrical fast transient 18

Electromagnetic compatibility 19
 Electromagnetic Compatibility (EMC) 20
 Electromagnetic Compatibility control Regulation 20
 Electromagnetic Compatibility Directive (2004/108/EC) 19
 Electromagnetic immunity 18
 Electrostatic discharge 18
 electrostatic discharge (ESD) 23
 EN 55022, Class B 19
 EN 55024 19
 EN60950 19
 enclosures 20
 encryption 25
 Environmental specifications 16
 errors 19
 ESD 23
 EU 19
 EU RoHS directive 21
 European Union (EU) requirements 19
 Execute Device Diagnostics 28

F

FCC verification 20
 Flush Cache 28
 Flush Cache Extended 28
 Formatted capacity 5

G

geometry 6
 gradient 16
 guaranteed sectors 6

H

Handling precautions 23
 humidity 16

I

I/O data-transfer rate 6
 Identify Device 28
 Identify Device command 30
 Idle 13, 28
 Idle Immediate 28
 Idle mode 7, 13
 Information Technology Equipment (ITE) 19
 Input noise ripple 12
 input voltage 7
 instanst secure erase drives 25
 interface 6, 26
 interference 20
 internal data-transfer rate OD 6
 is 7
 ISO document 7779 18
 ITE 19

K

KCC 20
 Korean Communications Commission 20
 Korean RRL 20

L

latency 7
 latency time 7
 LBA mode 6

logical geometry 6

M

maintenance 19

master/slave 3

maximum start current 8

mounting 24

mounting screws 17

mounting the drive 23

N

noise 12

nominal power 7

non-operating

temperature 16

Nonoperating shock 17

Nonoperating vibration 17

Nonrecoverable read errors 19

NOP 28

O

Operating power 7

Operating shock 17

Operating vibration 17

P

peak operating current 8

Physical characteristics 6

point-to-point 3, 23

Power consumption 7

power consumption 7

Power modes 13

Power specifications 7

Power-management modes 13

Power-on to Ready 7

precautions 23

printed circuit board 23

programmable power management 13

prominent discrete tone 18

R

Radiated RF immunity 18

radio and television interference 20

radio frequency (RF) 18

random seeks 7

Rated Workload 19

Read Buffer 28

Read Buffer DMA 28

Read DMA 28

Read DMA Extended 28, 29

read errors 19

Read Log Ext 28

Read Multiple 28

Read Multiple Extended 28

Read Native Max Address 28

Read Native Max Address Extended 28

Read Sectors 28

Read Sectors Extended 28

Read Sectors Without Retries 28

Read Verify Sectors 28

Read Verify Sectors Extended 28

Read Verify Sectors Without Retries 28

read/write actuator arm 7

Read/write power 7

recording density 6

recording method 6

Recording technology 6

relative humidity 16

Reliability 19

Request Sense Data Ext 28

RF 18

RMS read/write current 12

RoHS 21

RRL 20

S

S.M.A.R.T. Disable Operations 29

S.M.A.R.T. Enable Operations 29

S.M.A.R.T. Enable/Disable Autosave 29

S.M.A.R.T. Execute Offline 29

S.M.A.R.T. implementation 28

S.M.A.R.T. Read Attribute Thresholds 29

S.M.A.R.T. Read Data 29

S.M.A.R.T. Read Log Sector 29

S.M.A.R.T. Return Status 29

S.M.A.R.T. Save Attribute Values 29

S.M.A.R.T. Write Log sector 29

Safety certification 19

Sanitize Device 28

sanitize feature set 25

screws 17

sectors 6

Security Disable Password 28

Security Erase Prepare 28

Security Erase Unit 28

Security Freeze Lock 28

Security Set Password 29

Security Unlock 29

See "S.M.A.R.T. commands" on page 34 28

Seek 29

seek mode 7

Seek mode power 7

Seek time 7

Serial ATA (SATA) interface 26

serial ATA ports 3

Servo electronics 7

servo electronics 7

Set Features 29

Set Max Address 29

Set Max Address Extended 29

Set Multiple Mode 29

shipping container 16

Shock 17

single-track seeks 7

Sleep 13, 29

Sleep mode 13

sound 18

Specification summary table 4

spindle speed 6

Spinup power 7

- Standby 13, 29
- Standby Immediate 29
- Standby mode 7, 13
- standby timer 13
- Standby to Ready 7
- Start/stop times 7
- static-discharge 23
- subassembly 20
- Surge immunity 18
- T**
- temperature 7, 16
 - non-operating 16
- timer 13
- timers 13
- track density 6
- Track-to-track 7
- Track-to-track seek time 7
- U**
- UL60950-1 19
- V**
- Vibration 17
- voltage 7
- Voltage dips, interrupts 18
- Voltage tolerance 12
- W**
- weight 6
- Workload 19
- Write Buffer 29
- Write Buffer DMA 29
- Write DMA 29
- Write DMA Extended 29
- Write DMA FUA Extended 29
- Write Log DMA Ext 29
- Write Log Extended 29
- Write Multiple 29
- Write Multiple Extended 29
- Write Multiple FUA Extended 29
- Write Sectors 29
- Write Sectors Extended 29
- Write Sectors Without Retries 29



Seagate Technology LLC

AMERICAS Seagate Technology LLC 10200 South De Anza Boulevard, Cupertino, California 95014, United States, 408-658-1000

ASIA/PACIFIC Seagate Singapore International Headquarters Pte. Ltd. 7000 Ang Mo Kio Avenue 5, Singapore 569877, 65-6485-3888

EUROPE, MIDDLE EAST AND AFRICA Seagate Technology SAS 16-18 rue du Dôme, 92100 Boulogne-Billancourt, France, 33 1-4186 10 00

*Publication Number: 100695091, Rev. C
November 2012*