

LAKELAND™ KITCHEN SINKS

SERIES 7193

Thank you for selecting American-Standard...the benchmark of fine quality for over 100 years. To ensure that your installation proceeds smoothly-- please read these instructions carefully before you begin.

Certified to comply with ANSI A112.19.4.M
U.S. Patent No. 4,664,982
Other patents pending.
CAN/C.S.A. B-45
Observe local plumbing and building codes.

BEFORE YOU BEGIN...

Unpack new sink and inspect carefully for damage. Replace the sink in its original packing carton to protect it until you are ready to begin installation.

Recommended Tools & Materials

Silicone Sealant	Drill
Putty Knife	Basin Wrench
Pipe Wrench	Saber Saw
Channel Locks	Tubing Cutter
Phillips Screwdriver	Tape Measure
Regular Screwdriver	Hacksaw
Adjustable Wrench	Mineral Spirits

Refer to American Standard roughing-in information for specific dimensions for each model.

CUTOUT DIMENSIONS FOR SINKS:

Below are the dimensions needed to determine the cutout size for your installation. Select the correct diagram for your application and refer to the instructions below.

Locate and mark center lines of sink on countertop.

Provide proper clearance under the countertop for the faucet supply lines and the structural parts of the cabinet.

By using the diagrams below and measuring your sink, draw the outline of the sink onto the countertop. This is not the cutting outline.

Refer to the diagram for your sink and draw a line the required distance in from the sink outline. Cut on this line.

COUNTERTOP CUTOUT FOR NEW INSTALLATIONS

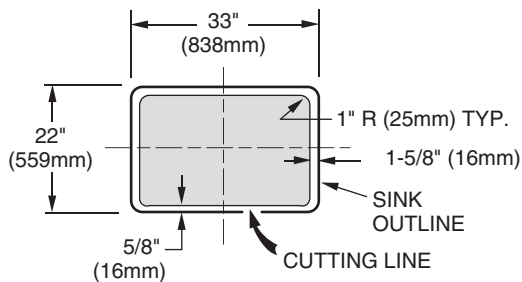

LAKELAND SINGLE BOWL MODEL 7193 SELF RIMMING

COUNTERTOP CUTOUT FOR REPLACEMENT INSTALLATIONS

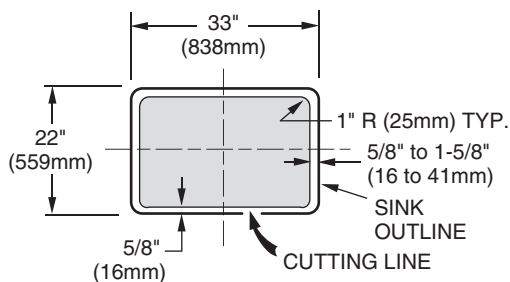

LAKELAND SINGLE BOWL MODEL 7193 SELF RIMMING

COUNTERTOP CUTOUT FOR UNDERCOUNTER INSTALLATIONS

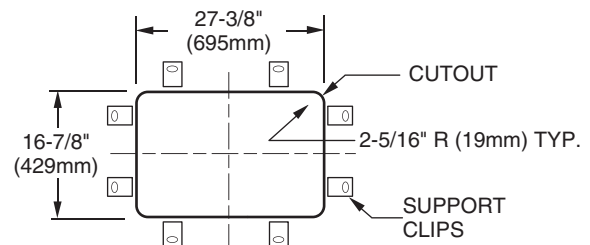

COUNTERTOP MOUNTED FAUCET MODEL 7193 UNDER COUNTER MOUNT LAKELAND SINGLE BOWL

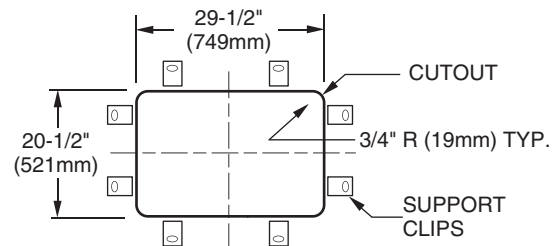

SINK MOUNTED FAUCET MODEL 7193 UNDER COUNTER MOUNT LAKELAND SINGLE BOWL

CAUTION:

1. Recommended Minimum Countertop Thickness Wood 19mm (3/4") Marble and Solid Surface 12mm (1/2")
2. Prior to cutting countertop ensure that the faucet shank has sufficient length to attach the mounting nut after the shank goes through both the countertop and the sink deck. The deck is 10mm (3/8") thick.

NOTE: Undercounter Installations of sinks should be done by trained and experienced installers due to the materials (such as marble, hard synthetics, etc.). Contact your countertop distributor for best method of cutting the opening.

IMPORTANT: DIMENSION OF FIXTURES ARE NOMINAL AND MAY VARY WITHIN THE RANGE OF TOLERANCES ESTABLISHED BY A.N.S.I. AND C.S.A. STANDARDS.

INSTRUCTIONS FOR COUNTERTOP MOUNTING.

AFTER THE CUTOUT IS DRAWN...

1

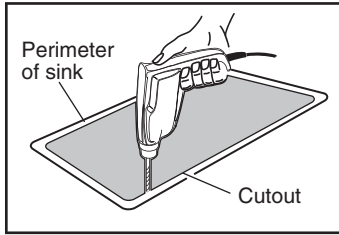

Drill a clearance hole inside the cutout line as marked on the countertop.

4

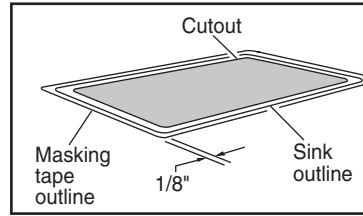

Remove sink and apply a masking tape outline 1/8" outside traced outline as a guide for application of silicone sealant.

2

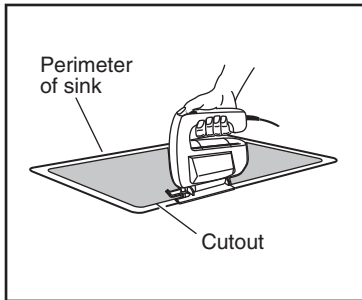

Cut opening on cut line inside the perimeter of sink.

Note - Formica countertop installation only is illustrated. Contact your countertop distributor for the best method of cutting other materials such as marble, hard synthetics, etc.

5

Apply a generous portion of silicone sealant inside line traced on countertop. Carefully lower sink into place and press down firmly. Use guidelines for proper positioning. Using water to dampen your finger, remove excess sealant for a smooth even line. Apply additional sealant if necessary to provide a uniform bead from the rim of sink to the masking tape line as shown. Carefully remove tape. Dampen finger and run it slightly over the sealant to remove any high spots. Use mineral spirits to remove excess silicone from countertop and sink.

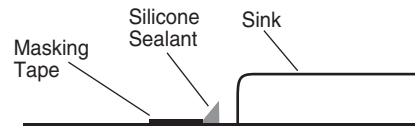

NOTE:
Silicone must be removed within 10 minutes of application or a permanent residue may remain on the surfaces.

3

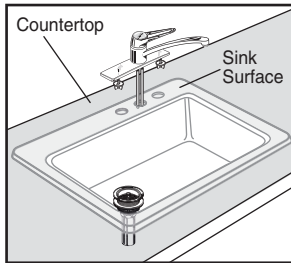

Mount the faucet and drain assembly on the sink or countertop following the manufacturer's instructions.

6

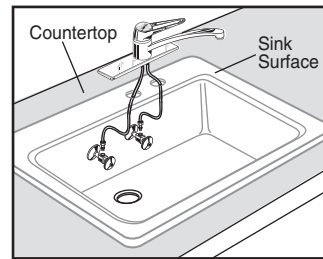

Connect supply lines to faucet finger tight, and carefully bend to engage with the supply stops. Tighten connections to faucet for secure seal.

7

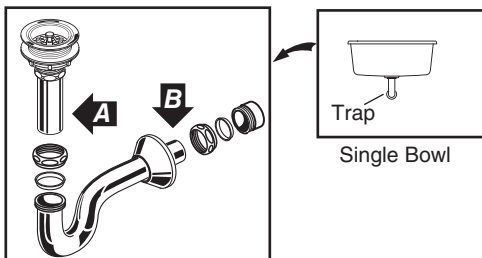

Connect drain assembly hand tight to check alignment. It may be necessary to cut off part of the tailpiece (area "A") or part of the horizontal leg of the trap (area "B").

Secure joint for watertight assembly.

INSTRUCTIONS FOR UNDERCOUNTER MOUNTED SINK WITH COUNTERTOP MOUNTED FAUCET.

1

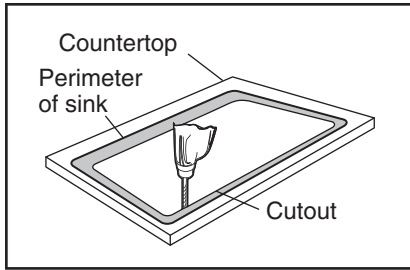

Drill a clearance hole inside the cutout line as marked on the countertop.

5

Apply a bead of sealant to the edge of the sink. Hold the sink against the under-side of the countertop and rotate the clips to hold the sink in place. Snug the screws to hold the sink. Attach all the additional clips.

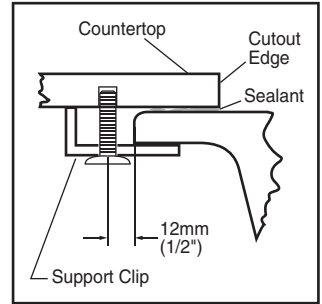

2

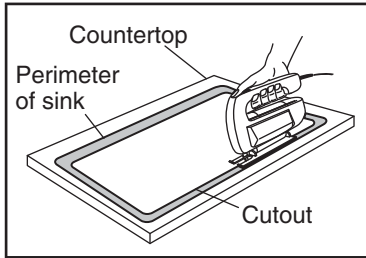

Cut opening on cut line inside the perimeter of sink.

Note - Formica countertop installation only is illustrated. Contact your countertop distributor for the best method of cutting other materials such as marble, hard synthetics, etc.

6

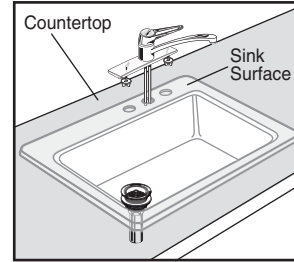

Mount the faucet and drain assembly on the sink or countertop following the manufacturer's instructions.

3

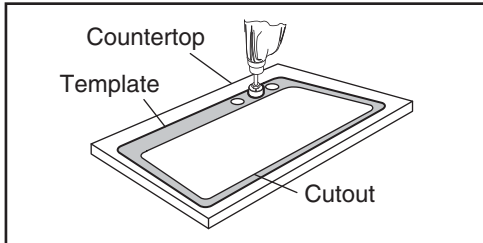

Cut faucet holes in the countertop and remove the template.

7

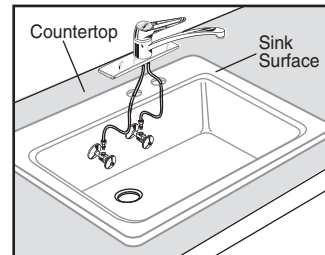

Connect supply lines to faucet finger tight, and carefully bend to engage with the supply stops. Tighten connections to faucet for secure seal.

CAUTION

Prior to beveling the countertop edge, be sure that the faucet escutcheon does not extend onto the curved portion of the countertop.

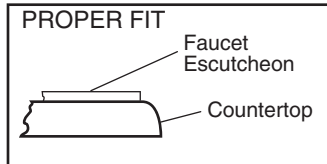

4

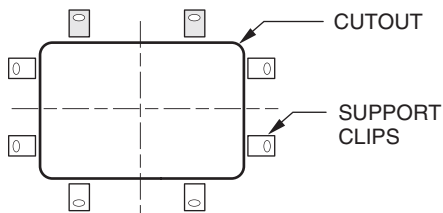

Attach at least eight of the support clips to the underside of the countertop as shown below. The location of the clips should be as shown in the sink diagram. The wood screws are for use in wood, plywood, or particle board (drill appropriate pilot hole). The inserts supplied are for use in marble or hard synthetic material.

8

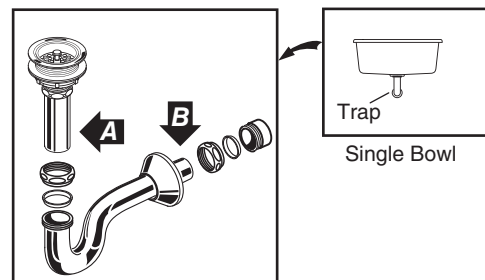

Connect drain assembly hand tight to check alignment. It may be necessary to cut off part of the tailpiece (area "A") or part of the horizontal leg of the trap (area "B").

Secure joint for watertight assembly.

INSTRUCTIONS FOR UNDERCOUNTER MOUNTED SINK WITH SINK TOP MOUNTED FAUCET.

1

Drill a clearance hole inside the cutout line as marked on the countertop.

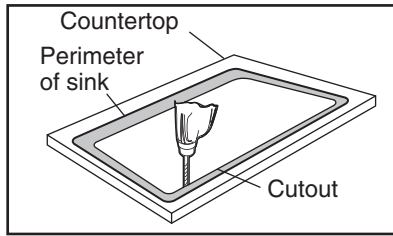

2

Cut opening on cut line inside the perimeter of the template.

Note - Formica countertop installation only is illustrated. Contact your countertop distributor for the best method of cutting other materials such as marble, hard synthetics, etc.

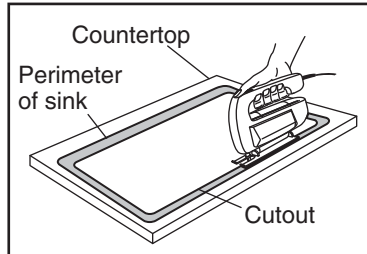

3

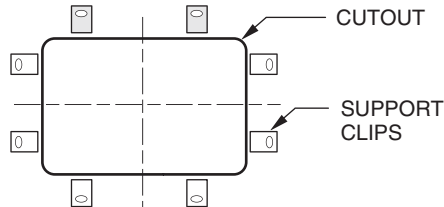

Attach at least eight of the support clips to the underside of the countertop as shown below. The location of the clips should be as shown in the sink diagram. The wood screws are for use in wood, plywood, or particle board (drill appropriate pilot hole). The inserts supplied are for use in marble or hard synthetic material.

4

Apply a bead of sealant to the edge of the sink. Hold the sink against the under-side of the countertop and rotate the clips to hold the sink in place. Snug the screws to hold the sink. Attach all the additional clips.

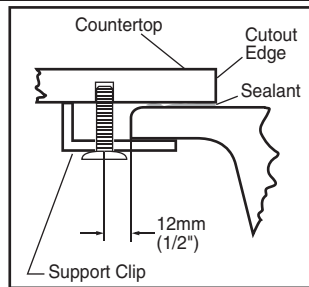

5

Mount the faucet and drain assembly on the sink or countertop following the manufacturer's instructions.

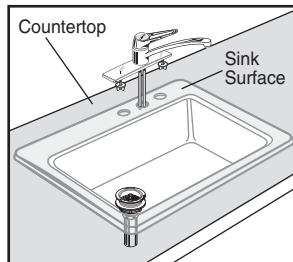

6

Connect supply lines to faucet finger tight, and carefully bend to engage with the supply stops. Tighten connections to faucet for secure seal.

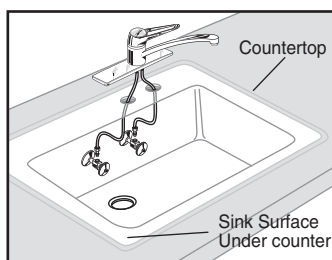

7

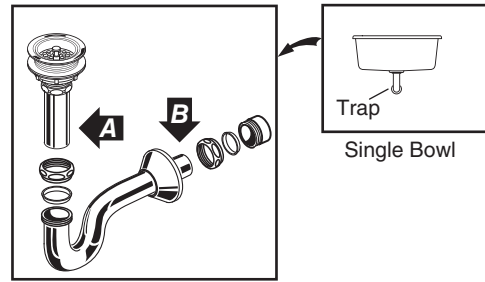

Connect drain assembly hand tight to check alignment. It may be necessary to cut off part of the tailpiece (area "A") or part of the horizontal leg of the trap (area "B").

Secure joint for watertight assembly.

CARE AND CLEANING...

For all porcelain enamel surfaces, regular, gentle care is best. The recommended way to preserve the finish, avoid scratches, and clean porcelain enamel fixtures is to rinse them with detergent and water. Generally, any of the light duty liquid dishwashing detergents, such as Palmolive or Dawn, work well. In areas where the water is hard, a heavy duty liquid laundry detergent such as liquid Tide will work better.

Product names listed herein are trademarks of American Standard Inc. unless otherwise noted.

Palmolive® is a registered trademark of Colgate-Palmolive Co.

Tide® and Dawn® are registered trademarks of Procter and Gamble.

AMERICAST® LIMITED LIFETIME WARRANTY

If an American-Standard Americast® brand product is found to be defective in materials or workmanship, after inspection by an authorized American-Standard representative, American-Standard will repair or, at its option, exchange the product for a similar model. This warranty extends for the lifetime of the product, so long as it remains in use in its original place of installation, except that the warranty applies to a bathing vessel's slip-resisting surface only for the first year after the product's initial installation.

This warranty applies only to the original purchaser and installation of these products.

This warranty **does not apply** to whirlpool components or to faucets, drains, mounting rims, grab bars or other accessories. If manufactured or supplied by American-Standard, such whirlpool components and accessories are covered under separate limited warranties.

This warranty **does not apply** to local building code compliance. Since local building codes vary considerably, the purchaser of this product should check with a local building or plumbing contractor to assure local code compliance before installation.

This warranty **shall be void** if the Americast® brand product has been moved from its initial place of installation; if it has been subjected to faulty maintenance, abuse, misuse, accident or other damage; if it was not installed in accordance with American-Standard's instructions; or if it was modified in a manner inconsistent with the product as shipped by American-Standard.

American-Standard's option to repair or exchange the product under this warranty does not cover any labor or other costs of removal or installation, **nor shall American-Standard be responsible for any other incidental or consequential damages attributable to a product defect or to the repair or exchange of a defective product, all of which are expressly excluded from this warranty.** (Some states or provinces do not allow the exclusion or limitation of implied warranties, so this exclusion may not apply to you.)

This warranty gives you specific legal rights. You may have other statutory rights that vary from state to state or from province to province, in which case this warranty does not affect such statutory rights.

For service under these warranties, it is suggested that a claim be made through the contractor or dealer from or through whom the product was purchased, or that a service request (including a description of the product model and of the defect) be sent to the following address:

In the United States:

American Standard Inc.

P.O. Box 6820

Piscataway, New Jersey 08855

Attention: Director of Consumer Affairs

For residents of the United States, warranty information may also be obtained by calling the following toll free number: (800) 442-1902

www.AmericanStandard-US.com

In Canada:

American Standard

2480 Stanfield Rd.

Mississauga, Ontario

Canada L4Y 1S2

Toll Free: (800) 387-0369

www.AmericanStandard.ca

In Mexico:

Customer Service Manager

Ideal Standard, S.A. de C.V.

Via Morelos #330

Col. Santa Clara

Ecatepec 55540 Edo. Mexico

www.AmericanStandard.com.mx