

# SanDisk uSSD 5000

---

## Product Manual

Revision 1

October 08



### SanDisk Corporation

Corporate Headquarters • 601 McCarthy Blvd. • Milpitas, CA 95035

Phone (408) 801-1000 • Fax (408) 801-8657

[www.sandisk.com](http://www.sandisk.com)

# Table of Contents

<b>1. Introduction .....</b>	<b>3</b>
1.1 General Description.....	3
1.1.1 Applications .....	3
1.1.2 Rugged and Reliable.....	3
1.1.3 High Performance .....	3
1.1.4 Cost Effective .....	3
1.2 Features.....	4
1.3 Scope .....	5
1.3.1 Technology Independence .....	5
1.3.2 Defect and Error Management .....	5
1.3.3 Wear-leveling .....	5
1.3.4 Bad Block Management.....	5
<b>2. Product Specifications .....</b>	<b>6</b>
2.1 Formatted Capacities.....	6
2.2 System Environmental Specifications.....	6
2.3 System Power Requirements .....	7
2.4 Voltage Ramp Down Recommendation .....	7
2.5 System Performance .....	8
2.6 System Reliability .....	9
2.6.1 MTTF.....	9
2.7 Endurance .....	10
2.8 Electrical Interface .....	10
2.8.1 uSSD Connector .....	10
2.8.2 Electrical Specifications.....	11
2.9 Physical Specifications .....	12
2.9.1 Standard Configuration .....	12
2.9.2 Low Profile Configuration .....	13
2.9.3 uSSD-to-USB Adapter.....	13
2.10 Product Markings and Traceability .....	14
2.11 OS Support.....	15
2.12 Regulatory Compliance .....	15
<b>Ordering Information .....</b>	<b>16</b>
<b>Disclaimer of Liability .....</b>	<b>17</b>

## List of Tables

Table 1: Formatted Capacities .....	6
Table 2: Environmental Specifications .....	6
Table 3: Power Requirements.....	7
Table 4: Performance.....	8
Table 5: Reliability .....	9
Table 6: uSSD MTTF .....	9
Table 7: Host Interface 2x5 On-Board Header .....	10
Table 8: Absolute Maximum Ratings.....	11
Table 10: DC Characteristics for Full-Speed Operation (TA = 25°C) .....	11
Table 11: DC Characteristics for High-Speed Operation (TA = 25°C).....	11
Table 11: Physical Dimensions .....	12
Table 12: OS Support .....	15
Table 13: Ordering Information .....	16

# 1. Introduction

## 1.1 General Description

The SanDisk uSSD takes the benefits of flash storage to new markets with low-capacity storage requirements, most notably the low-cost PC (LCPC). Rugged and reliable, it is a fraction of the size and cost of a hard disk drive (HDD) in the 1 to 16 GB range. SanDisk adds high performance to the uSSD offering, based on an advanced controller that exemplifies the company's years of USB expertise.

### 1.1.1 Applications

The SanDisk uSSD offers a no-compromise flash-based storage solution for:

- LCPCs that need rugged reliability and require up to 4 GB. The uSSD can meet these requirements more cost-effectively than an HDD

- Desktops that support Microsoft® Vista and can benefit from enabling ReadyBoost® up to 4GB.

- Point of sale (POS) stations, where the uSSD replaces the HDD

- Blade servers, where the uSSD is ideal to store critical backup files and provide boot functionality

### 1.1.2 Rugged and Reliable

Unlike the HDD, the SanDisk uSSD has no moving parts. It keeps working in challenging environments such as classrooms, kiosks and on space-restricted server floors. The patented flash management technology brings top data integrity to the uSSD, even during power losses. Dynamic bad block management, dynamic and static wear-leveling, and robust error detection and correction code (EDC/ECC) ensure data reliability.

### 1.1.3 High Performance

The uSSD achieves a sustained read speed as high as 30 MB/sec and a sustained write speed of up to 20 MB/sec with single-level cell (SLC) technology.

### 1.1.4 Cost Effective

There is no need to pay for more capacity than you require. The uSSD lets you purchase just the right amount of storage, packed inside a memory device that's 25% smaller than a 1.8" HDD. It offers you the choice of single-level cell (SLC) flash technology or the more cost-effective multi-level cell (MLC) technology.

## **1.2 Features**

The SanDisk uSSD 5000 provides the following system features:

- Non-volatile storage (no battery required)

- USB 2.0 interface, certified by the USB organization

  - (<http://www.usb.org/home>)

- Complies with Microsoft Vista ReadyBoost® requirements

- Up to 16 GB of mass storage based on SanDisk's reliable flash technology

- SLC flash and MLC flash-based configurations

- Fixed configuration (not removable)

- Low power consumption

- High performance:

  - Sustained Read and write speed of up to 30 MB/sec for reading, 20 MB/sec for writing (SLC configuration)

- Rugged

- Lightweight

- Silent

- Standard and low profile

- Advanced error detection and error correction algorithms

- Advanced wear-leveling algorithms

- Guaranteed data integrity even after power loss

- MTTF > 8,000,000 hours

- Multiple OS support

- Warranty: 3 years

## **1.3 Scope**

This document describes the key features and specifications of the uSSD 5000, as well as the information required to interface this product to a host system.

### **1.3.1 Technology Independence**

To write or read a sector (or multiple sectors), the host computer software simply issues a Read or Write command to the module.

This command contains the address and the number of sectors to write/read. The host software then waits for the command to be completed.

The host software does not participate in the details of how the flash memory is erased, programmed or read. This is extremely important as flash devices are expected to increase in complexity in the future. Because the uSSD 5000 uses an intelligent on-board controller, the host system software will not need to be changed as new flash memory evolves. As such, systems that support uSSD 5000 now will be able to access future SanDisk Modules built with new flash technology without any need to update or change the host software.

### **1.3.2 Defect and Error Management**

The uSSD 5000 contains a sophisticated defect and error management system.

If necessary, the Module will rewrite data from a defective sector to a good sector. This is completely transparent to the host and does not consume any user data space.

The uSSD 5000 soft error rate specification is much better than the magnetic disk drive specification.

In the extremely rare case that a read error does occur, the uSSD 5000 has innovative algorithms to recover the data by using hardware on-the-fly Error Detection Code/Error Correction Code (EDC/ECC), based on a BCH algorithm.

These defect and error management systems, coupled with solid state construction, give the SanDisk uSSD 5000 unparalleled reliability.

### **1.3.3 Wear-leveling**

Wear-leveling is an inherent part of the erase-pooling functionality of the SanDisk uSSD 5000, using NAND memory.

Advanced features of dynamic and static wear-leveling and automatic block management are used to ensure high data reliability and maximize flash life expectancy.

### **1.3.4 Bad Block Management**

Bad blocks are occasionally created during the lifecycle of a flash component, in a phenomenon called dynamic bad block accumulation. These bad blocks must be dynamically marked and replaced to prevent read/write failures.

When a bad block is detected, the embedded bad block mapping algorithm maps out the block, which is then no longer used for storage.

## 2. Product Specifications

For all the following specifications, unless otherwise stated, values are defined at ambient temperature and nominal supply voltage.

### 2.1 Formatted Capacities

Table 1 shows the formatted capacities for the uSSD 5000:

**Table 1: Formatted Capacities**

Capacity [GB]	Capacity (formatted in bytes)	Sectors/Module (Max. LBA+1)	No. of Heads	No. of Sectors/Track	No. of Cylinders
<b>SLC Configurations</b>					
1	1,002,438,656	1,957,537	16	63	1,942
2	2,048,900,608	4,001,760	16	63	3,969
4	4,110,188,032	8,027,712	16	63	7,963
8	8,220,645,376	16,055,949	16	63	15,928
<b>MLC Configurations</b>					
2	2,048,900,608	4,001,760	16	63	3,969
4	4,110,188,032	8,027,712	16	63	7,963
8	8,220,645,376	16,055,949	16	63	15,928
16	16,441,481,216	32,112,269	16	63	31,857

### 2.2 System Environmental Specifications

Table 2 lists the environmental specifications, including temperature, noise level, vibration, shock and altitude.

**Table 2: Environmental Specifications**

Specification	Parameters
Temperature	<b>Operating (Commercial):</b> 0° C to 70° C <b>Storage temp without user data retention:</b> -40° C to 85° C <b>Storage temp with user data retention:</b> 0° C to 70° C
Noise Level	0 dB
Vibration	<b>Operating:</b> 2.17gRMS (20Hz to 2000Hz, 3 vibration axes, 60 min) <b>Non operating:</b> 3.08 gRMS (20 Hz to 2000 Hz)
Shock	<b>Operating:</b> 50 g, 11 msec duration, half sine <b>Non operating:</b> 1,500 g, 0.5 msec duration, half sine
Altitude (relative to sea level)	80,000 ft. maximum
ESD	<b>Contact discharge:</b> Up to 4 KV (enclosed in a host) <b>Air discharge:</b> Up to 8 KV (enclosed in a host)
Flammability ratings for major components	<b>PCB:</b> 888-1 94V0 HK <b>ASIC Packaging materials:</b> 94V0 <b>Flash packaging materials:</b> 94V0 <b>Labels:</b> CM-100-SM, CM-200-WS

## 2.3 System Power Requirements

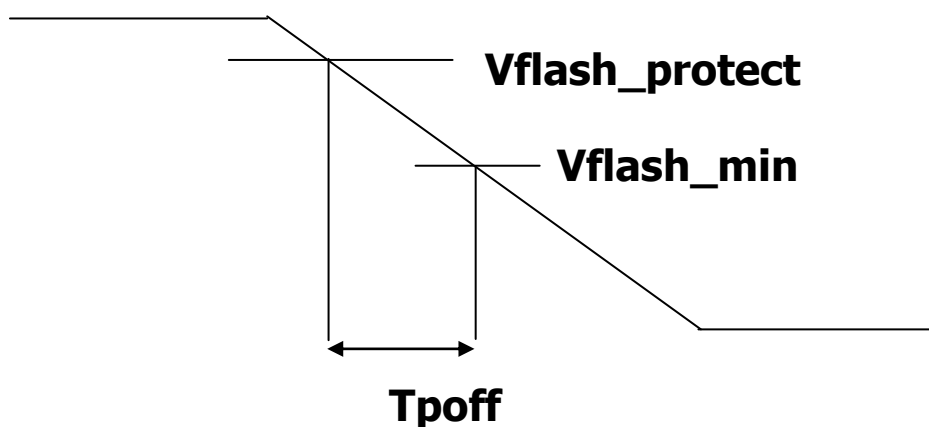
All values quoted in Table 3: Power Requirements

are typical at 25° C and nominal supply voltage unless otherwise stated.

**Table 3: Power Requirements**

Power Mode	5V +/- 10% IDD	5V +/- 10% IDD
Products	SLC 1GB, 2GB, 4GB, 8GB MLC 2GB	MLC 4GB, 8GB, 16GB
Standby	2.5 mA	2.5 mA
Operating HS Read	150 mA	200 mA
Operating HS Write	150 mA	200 mA
Idle HS	100 mA	100 mA

## 2.4 Voltage Ramp Down Recommendation



	Memory	Min	Typ	Max	Unit
<b>Tpoft</b>	Binary	1	-	-	ms
	MLC	3	-	-	ms
<b>Vflash_protect</b>	Any	4.27	4.38	4.49	V
<b>Vflash_min</b>	Any	-	-	2.7	V



## 2.5 System Performance

Table 4 lists the performance parameters of the SLC and MLC flash-based configurations:

**Table 4: Performance**

Specification	Parameters
<b>Maximum performance for 1 GB, 2 GB, 4GB and 8GB (SLC flash configurations)</b>	
<b>Sequential Read</b>	30 MB/sec
<b>Sequential Write</b>	20 MB/sec
<b>Random Read</b>	30 MB/sec
<b>Random Write</b>	6 MB/sec
<b>Maximum performance for 2 GB (MLC configuration)</b>	
<b>Sequential Read</b>	27 MB/sec
<b>Sequential Write</b>	6 MB/sec
<b>Random Read</b>	25 MB/sec
<b>Random Write</b>	2.2 MB/sec
<b>Maximum performance for 4 GB, 8 GB and 16GB (MLC configuration)</b>	
<b>Sequential Read</b>	27 MB/sec
<b>Sequential Write</b>	12 MB/sec
<b>Random Read</b>	25 MB/sec
<b>Random Write</b>	3.5 MB/sec
<b>Host compatibility</b>	
<b>USB 2.0</b>	Up to 60 MB/sec

Note: Random read and write were measured on Windows 2000 with HDBench on a 100MB file transfer

## 2.6 System Reliability

**Table 5: Reliability**

Specification	Parameters
Data Reliability	Error detection / error correction based on BCH algorithm
Data integrity after power loss	Data is guaranteed after power loss
Bad blocks	Transparent bad block management
Wear-leveling	Dynamic and Static Wear-leveling

### 2.6.1 MTTF

The reliability figure of merit most often used for electronic equipment is Mean Time To Failure (MTTF). SanDisk estimates MTTF using a prediction methodology based on reliability data for the individual components in SanDisk products.

Component data comes from several sources: device life tests, failure analysis of earlier equipment, device physics, and field returns.

SanDisk uses following methods to predict reliability:

Telcordia Special Report SR-332, Reliability Prediction Procedure for Electronic Equipment (RPP).

British Telecom Industry HRD5, Handbook of Reliability Data for Electronic Components used in Telecommunication System.

Table 6 summarizes the MTTF prediction results for various uSSD configurations. The analysis was performed using a RAM Commander™ failure rate prediction.

**Failure Rate:** The total number of failures within an item population, divided by the total number of life units expended by that population, during a particular measurement interval under stated condition.

**Mean Time To Failures (MTTF):** A basic measure of reliability for repairable items: The mean number of life units during which all parts of the item perform within their specified limits, during a particular measurement interval under stated conditions.

**Table 6: uSSD MTTF**

Product	Condition	MTTF (Hours)
1GB, 2GB, 4GB	Telcordia SR-332, GB, 25°C	10M
8GB, 16GB	Telcordia SR-332, GB, 25°C	8M

## 2.7 Endurance

The uSSD5000 SLC flash-based configurations have guaranteed endurance of 3 years for all capacities (1, 2, 4 and 8GB).

The uSSD5000 MLC flash-based configurations have guaranteed endurance of 3 years as follows:

- BAPCO Student profile – uSSD MLC 8GB and up.
- BAPCO Personal profile – uSSD MLC 4GB and up.

## 2.8 Electrical Interface

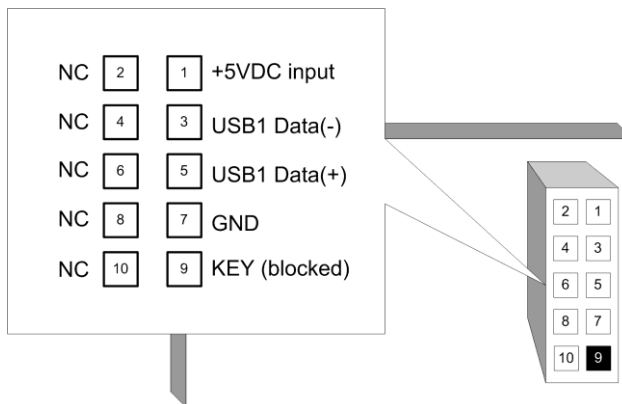
Table 7 lists the host interface on-board header pins and signals.

**Table 7: Host Interface 2x5 On-Board Header**

Pin	Signal	Pin	Signal
1	+5VDC	2	+5VDC
3	USB1 Data(-)	4	USB2 Data(-)
5	USB1 Data(+)	6	USB2 Data(+)
7	GND	8	GND
9	Key (no pin)	10	NC

### 2.8.1 uSSD Connector

Figure 1 illustrates the uSSD 2x5 device interface connector:



**Figure 1: uSSD 2x5 Connector Pinout**

## 2.8.2 Electrical Specifications

### 2.8.2.1 Absolute Maximum Ratings

**Table 8: Absolute Maximum Ratings**

Parameter	Symbol	Min	Max	Unit
Ambient Operating Temperature Range (Commercial)	T <sub>A</sub>	0	70	°C
Power Supply Voltage Relative to Ground	V <sub>bus</sub>	0	5.5	V
Voltage level on D+ / D- Relative to Ground 3	V <sub>data</sub>	-0.3	5.8	V

### 2.8.2.2 DC Characteristics

**Table 9: DC Characteristics for Full-Speed Operation (TA = 25°C)**

Parameter - USB Signals	Symbol	Min	Typ	Max	Unit
Supply Voltage:	V <sub>BUS</sub>	4.5	5.0	5.5	V
Supply Current (RMS):					
Operating	I <sub>CC</sub>	-	120	150	mA
Suspend	I <sub>CCS</sub>	-	1.6	2.5	mA
Max Current Consumption (Peak Value)		-	-	150	mA
Input Levels USB Signals (D+, D-):					
Low	V <sub>IL</sub>	-	-	0.8	V
High	V <sub>IH</sub>	2.0	-	-	V
Output Voltage USB Signals (D+, D-):					
Low	V <sub>OL</sub>	0.0	-	0.3	V
High	V <sub>OH</sub>	2.8	-	3.6	V
Output Signal Crossover Voltage USB Signals (D+, D-)	V <sub>CRS</sub>	1.3	-	2.0	V

**Table 10: DC Characteristics for High-Speed Operation (TA = 25°C)**

Parameter - USB Signals	Symbol	Min	Typ	Max	Unit
Supply Voltage:	V <sub>BUS</sub>	4.5	5.0	5.5	V
Supply Current (RMS)					
Operating	I <sub>CC</sub>	-	120	150	mA
Suspend	I <sub>CCS</sub>	-	1.6	2.5	mA
Max Current Consumption (Peak Value)		-	-	150	mA
Input Levels USB Signals (D+):					
Low	V <sub>IL</sub>	-10	-	10	mV
High	V <sub>IH</sub>	360	-	440	mV
Input Levels USB Signals ( D-):					
Low	V <sub>IL</sub>	360	-	440	mV
High	V <sub>IH</sub>	-10	-	10	mV
Output Voltage USB Signals (D+, D-):					
Low	V <sub>OL</sub>	-10		10	mV
High	V <sub>OH</sub>	360		440	mV

## 2.9 Physical Specifications

SanDisk offers the uSSD 5000 in 2 form factors:

- Standard profile

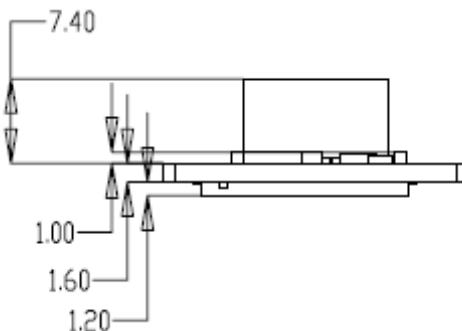
- Low profile

Table 11 and Figure 2, Figure 3 and Figure 5 list the physical specifications and dimensions of the uSSD 5000.

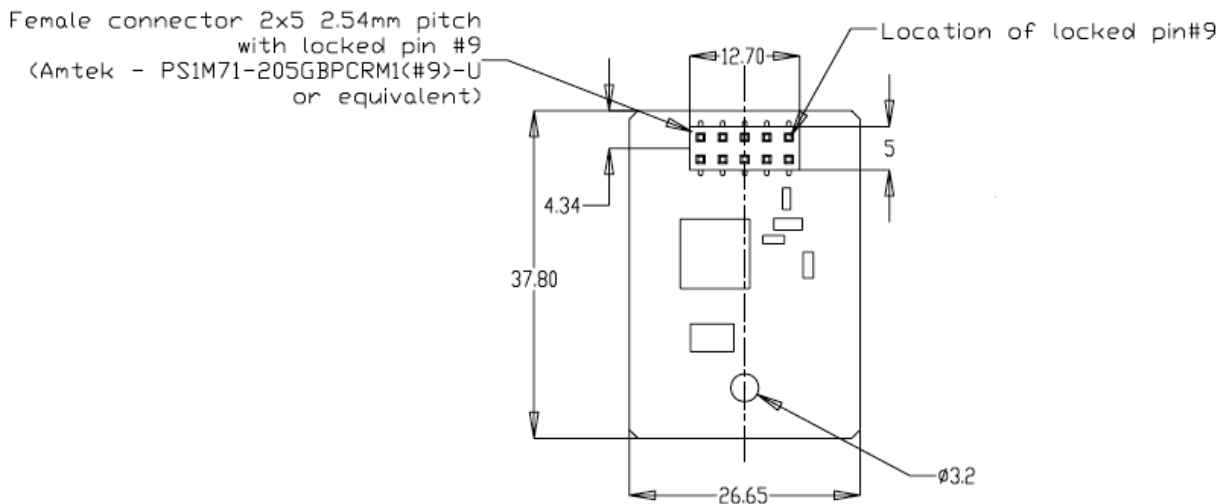
**Table 11: Physical Dimensions**

Dimension	Parameters
Weight	4.9g
Length	Standard and Low Profile: 37.80 ± 0.25 mm
Width	Standard and Low Profile: 26.65 ± 0.25 mm
Thickness	Standard profile: 10.60 ± 0.25 mm Low Profile: 6.58 ± 0.25 mm

### 2.9.1 Standard Configuration

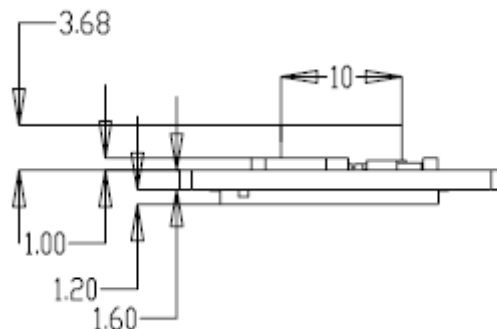


**Figure 2: uSSD Standard Version, Side View**

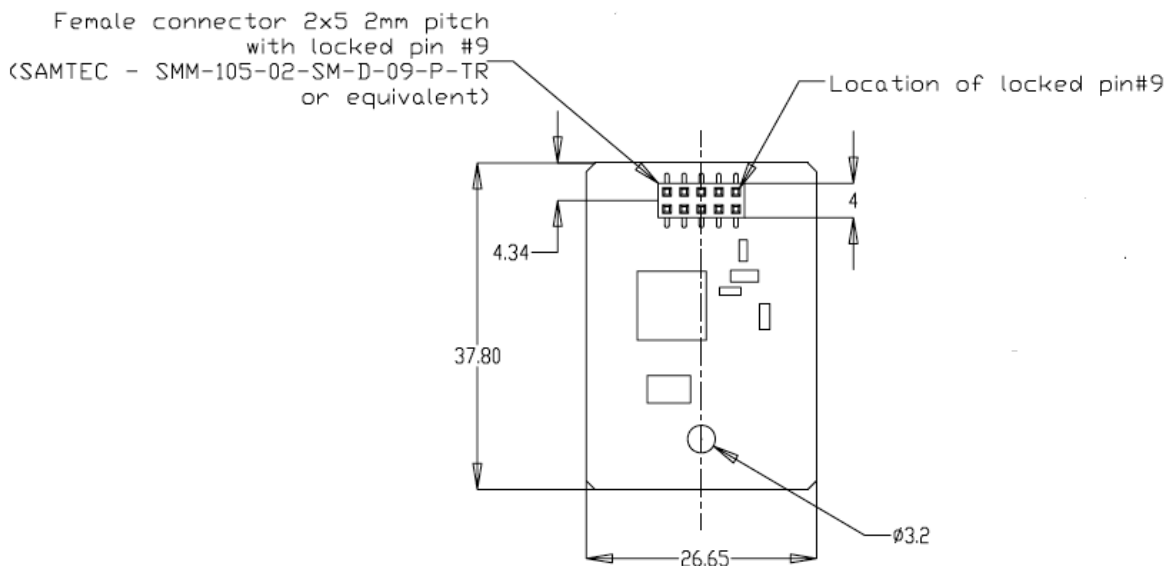


**Figure 3: uSSD Standard Version, Bottom View**

**2.9.2 Low Profile Configuration**



**Figure 4: uSSD 2x5 Low Profile Version, Side View**



**Figure 5: uSSD 2x5 Low Profile Version, Bottom View**

**2.9.3 uSSD-to-USB Adapter**

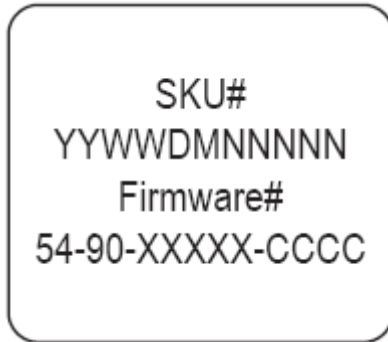
An adapter is available to assist customers in evaluating the uSSD 5000. The adapter enables inserting the uSSD 5000 in an external desktop or laptop USB port.

The adaptor is available at its leaded format for purchasing and its SKU is SDADP-UC-001



**Figure 6: uSSD External USB Adapter**

## 2.10 Product Markings and Traceability



SKU# Ordering Info See Appendix A for further options

SDUS5AB-001G - SD SanDisk

US5 uSSD 5000

A standard profile with LED /E low Profile with LED/  
/F low Profile with external LED

B Binary (SLC)/J MLC

YYWWDMMNNNNN -YY year

WW week

D Month day

M Subcontractor code

NNNNN Running serial number

Firmware# - according to Bill of Material

54-90-XXXXX-CCCC Internal SanDisk subunit Number

## 2.11 OS Support

The uSSD 5000 is supported under the operating systems listed in Table 12. In the standard boot and storage modes, the uSSD 5000 is recognized as a fixed disk in the system. The system can also boot from the uSSD 5000, eliminating the need for additional components.

Software packages for the supported operating systems can be downloaded from the SanDisk website, along with the relevant documentation.

**Table 12: OS Support**

Operating System	Version	Support
Windows XP Pro	Service Pack 2	SanDisk driver
Windows XP Embedded	SP2 FP 2008	Native in the OS
Windows Vista (Storage and ReadyBoost support)	32 bit + 64 bit	Native in the OS
Windows Embedded for Point of Service (WEPOS)	Service Pack 2	SanDisk driver
Windows Server 2003		SanDisk driver
Windows CE	5.0 and 6.0	Native in the OS
Linux	Kernel 2.6.XX	Native in the OS
DOS		Native in the OS

## 2.12 Regulatory Compliance

The uSSD 5000 complies with the following:

- USB Organization certification

- RoHS (6 Materials)

- Chinese RoHS

- FCC Class B for Information Technology [MIC, BMSI, VCCI]

- CE EN 55022/55024

- UL 60-950-1 CSA C22.2 No. 60950-1-03

- WHQL for Windows Xp, Windows Vista and Windows server 2003

- Windows Vista ReadyBoost® compliance



## Ordering Information

**Table 13: Ordering Information**

SKU	Capacity	Standard Profile	Low Profile	Internal Led	External Led	MLC	Binary
SDUS5AB-001G	1GB	X		X			X
SDUS5EB-001G	1GB		X	X			X
SDUS5EB-001G-1190	1GB		X	X			X
SDUS5FB-001G-1036	1GB		X		X		X
SDUS5AB-002G	2GB	X		X			X
SDUS5AJ-002G	2GB	X		X		X	
SDUS5EB-002G	2GB		X	X			X
SDUS5EJ-002G	2GB		X	X		X	
SDUS5FB-002G	2GB		X		X		X
SDUS5FB-002G-1036	2GB		X		X		X
SDUS5FJ-002G	2GB		X		X	X	
SDUS5AB-004G-1036	4GB	X		X			X
SDUS5FB-004G	4GB		X		X		X
SDUS5FJ-004G	4GB		X		X	X	
SDUS5AB-004G	4GB	X		X			X
SDUS5AB-004G-1035	4GB	X		X			X
SDUS5AJ-004G	4GB	X		X		X	
SDUS5EB-004G	4GB		X	X			X
SDUS5EJ-004G	4GB		X	X		X	
SDUS5AB-008G	8GB	X		X			X
SDUS5FB-008G	8GB		X		X		X
SDUS5FJ-008G	8GB		X		X	X	
SDUS5AB-008G-1035	8GB	X		X			X
SDUS5AJ-008G	8GB	X		X		X	
SDUS5EB-008G	8GB		X	X			X
SDUS5EJ-008G	8GB		X	X		X	
SDUS5AJ-016G	16GB	X		X		X	
SDUS5EJ-016G	16GB		X	X		X	
SDUS5FJ-016G	16GB		X		X	X	

1 megabyte (MB) = 1 million bytes; 1 gigabyte (GB) = 1 billion bytes. Some of the listed capacity is used for formatting and other functions, and thus is not available for data storage.

## Disclaimer of Liability

### SanDisk Corporation Policy

SanDisk Corporation general policy does not recommend the use of its products in life support applications wherein a failure or malfunction of the product may directly threaten life or injury.

Accordingly, in any use of products in life support systems or other applications where failure could cause damage, injury or loss of life, the products should only be incorporated in systems designed with appropriate redundancy, fault tolerant or back-up features.

SanDisk shall not be liable for any loss, injury or damage caused by use of the Products in any of the following applications:

- Special applications such as military related equipment, nuclear reactor control, and aerospace
- Control devices for automotive vehicles, train, ship and traffic equipment
- Safety system for disaster prevention and crime prevention
- Medical-related equipment including medical measurement device