

**FCC Compliance**

This equipment has been tested and found to comply with the limits for a Class B digital device, pursuant to Part 15 of the FCC rules. These limits are designed to provide reasonable protection against harmful interference in a residential installation. This equipment generates, uses, and can radiate radio frequency energy and, if not installed and used in accordance with the instructions, may cause harmful interference to radio communications. However, there is no guarantee that interference will not occur in a particular installation. If this equipment does cause harmful interference to radio or television reception, which can be determined by turning the equipment off and on, the user is encouraged to try to correct the interference by one or more of the following measures:

- Re-orient or relocate the receiving antenna.
- Increase the separation between the equipment and receiver.
- Connect the equipment into an outlet on a circuit different from that to which the receiver is connected.
- Consult the dealer or an experienced radio/TV technician for help.

**CAUTION**

Change or modifications not expressly approved by the manufacturer responsible for compliance could void the user's authority to operate the equipment.

**LASER STANDARD**  
IEC 60825-1 :1993 +A1 :1997 +A2 :2001

**WEEE**

**Correct Disposal of This Product (Waste Electrical & Electronic Equipment)**

(Applicable in the European Union and other European countries with separate collection systems)

This mark shown on the product or its literature, indicates that it should not be disposed with other household wastes at the end of its working life. To prevent possible harm to the environment or human health from an uncontrolled waste disposal, please separate this from other types of wastes and recycle it responsibly to promote the sustainable reuse of material resources.

Household users should contact either the retailer where they purchased this product or their local government office, for details of where and how they can take this item for environmentally safe recycling.

Business users should contact their supplier and check the terms and conditions of the purchase contract. This product should not be mixed with other commercial wastes for disposal.

• **Samsung Eco-mark**  
The Samsung's own Eco mark helps consumers to easily understand that Samsung develops eco-friendly products. This mark represents Samsung's continuous effort to develop eco-friendly products.

• **RoHS**  
(Restriction of the use of certain hazardous substances in electrical and electronic equipment)  
The RoHS, the environmental regulation announced by European Union, restricts the use of lead, mercury, cadmium, hexavalent chromium, PBB, and PBDE in products put on the market in The European Union after July 1, 2006.

BG68-01412A REV.02

- <http://www.samsung-ODD.com>  
- <http://www.samsung.com>

**Safety Precautions**

The following are basic precautions to ensure user safety and reduce the risk of property damage.

**• When you install the drive**

**Place the drive on a level surface.**

- Failure to do so may cause the device to fall onto a hard surface, resulting in damage or malfunction.

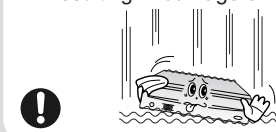

- Do not place the drive in direct sunlight.

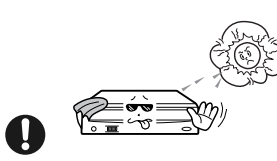

**• While operating**

**Handle with caution to prevent damage from an external shock.**

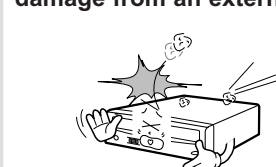

**Do not drop the drive, and protect it from severe shocks.**

- It can damage the drive or cause it to malfunction.

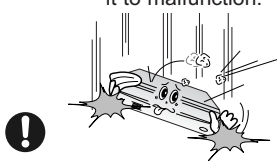

**• Other**

- Never allow food particles or foreign substances to enter the drive casing.

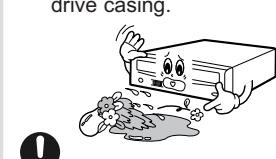

- To protect against the risk of fire, do not spill such liquids as alcohol and benzene on the drive.

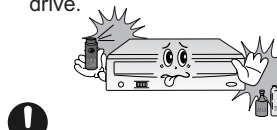

• Any change or modification not expressly approved by designated qualified personnel could void your authority to operate this device.

**Warning/Caution**



**Warning:** To warn the user that failure to comply with the instructions may result in serious injury or death.

**Caution:** To caution the user that failure to comply with the instructions may result in damage to property.

**Introduction**

- Design and specifications are subject to change without prior notice.

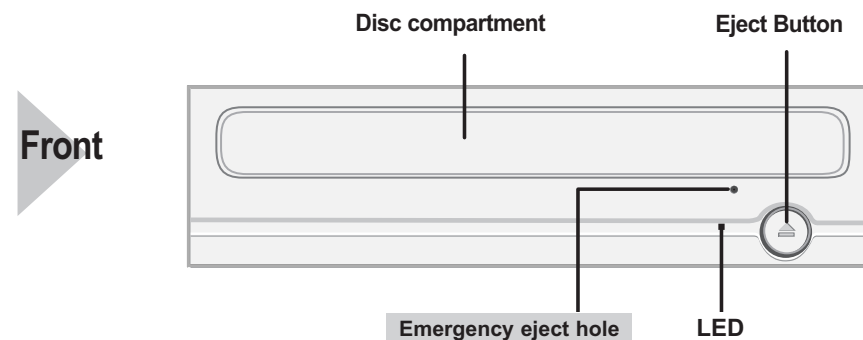

**Emergency eject hole**

If the compartment does not open when you press the Eject button, power off the computer, insert a pin or unfolded paper clip in the hole and push firmly)

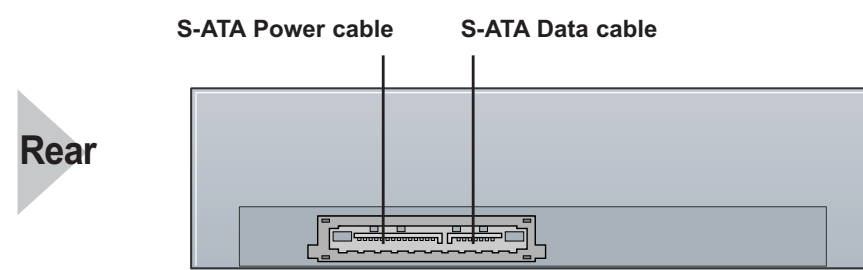

**Accessories**

User Guide, Screw 4ea

The type of accessories varies depending on a product model, and some accessories described herein are subject to change without notice.

**Connecting the Cables to the DVD Writer**

**Connecting the Cables**

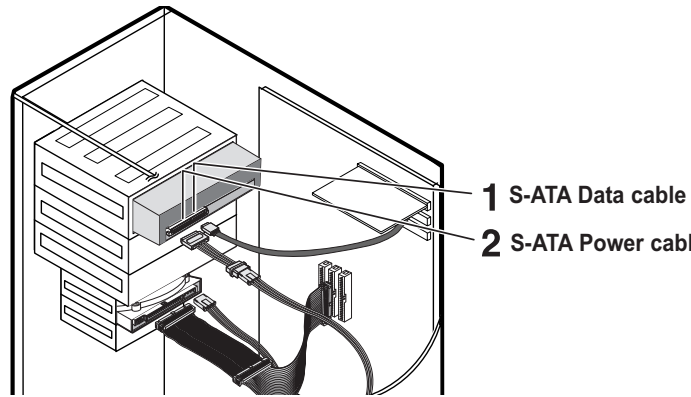

**1 Connecting the power cable**

- The 4-pin power cable from the internal power unit of your computer must be connected to the power terminal the rear of the DVD Writer drive.

**2 Connecting the S-ATA cable**



**Installing the Drive**

**System Requirements**

S-ATA supported PC  
(The compatible motherboard list can be found from the website)  
256Mbytes or above

**Installing the DVD Writer**

How to install the DVD Writer on your PC. First, remove the cover; connect the cable to the DVD Writer and then to the PC.

**1 If necessary, attach a horizontal bracket to both sides of the drive.**

- You can purchase these accessories separately from your computer dealer.  
(Screws for use: M3 X 6 X 4)

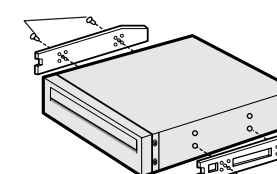

**2 Remove the plate from a free expansion slot and install the DVD Writer, as shown in the illustration.**

- If you have no free expansion slot, install the drive in place of the diskette drive.
- Make sure to use the standardized screws supplied (M3X6).  
- To use screws other than M3X6 may result in malfunction.

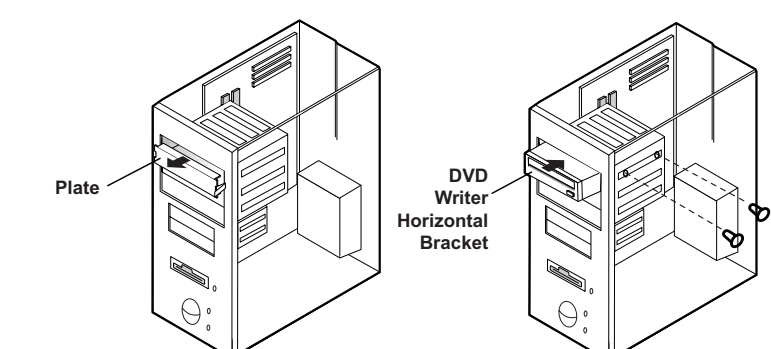

**Using the Drive/Storing and Cleaning Your Discs**

**Using the DVD Writer**

- 1 Push the power button and boot the computer.**
- 2 After booting the computer, open the disc partment by pressing the Eject button.**
- 3 Insert the disc (CD) with the label on the disc facing upwards and close the disc compartment by pressing the Eject button. The indicator light comes on.**
- 4 Play the disc (CD).**

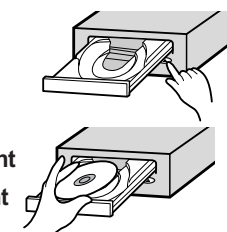

**Playing CD-DA/Audio CDs**

- Run the CD player program supplied with the sound card or play the Windows Media Player.

**Playing Video CDs**

- Follow the instructions provided with the disc.
- A video card or MPEG software and a sound card need to be installed to view video CDs.
- **If the drive is vertically installed, you cannot use an 8 cm Mini Disc because the disc is movable.**

**Storing Your Discs**

- Do not place a disc in direct sunlight.
- Store a disc vertically in a well-ventilated and stable location.
- Do not write or attach a label on a disc.
- Do not drop a disc or place heavy objects on it.

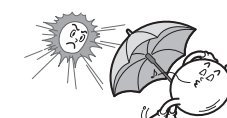

**Cleaning Your Discs**

- Do not touch the surface of a disc; hold it by the edges.
- To clean a disc, polish lightly from the inside of the disc to the outside with a soft cotton cloth.

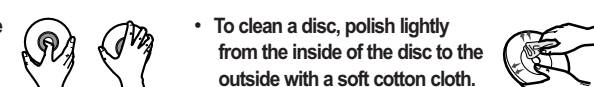

• The disc may not function properly if there are fingerprints, foreign substances or dust on the disc surface.

**Solving Technical Problems**

- The friction noise generated during SPIN-UP and STOP is caused by the Automatic Ball Balancing System(ABS) and is not a malfunction.

<b>The tray won't open.</b>	<ul style="list-style-type: none"> <li>• See if the PC is on.</li> <li>• Make sure the power cable within the PC is connected properly.</li> <li>• If the tray still won't open with the power-on, turn the power-off and insert a pin(paper clip) into the emergency hole to open.</li> </ul>
<b>The tray won't close.</b>	<ul style="list-style-type: none"> <li>• Make sure the disc has been inserted properly.</li> </ul>
<b>The PC is not working properly.</b>	<ul style="list-style-type: none"> <li>• See if the jumper(s) is properly connected to the Master/Slave Selection port.</li> <li>• See if the drive is properly connected to the PC.</li> <li>• See if the floppy disc remains in the PC.</li> </ul>
<b>The drive is not working properly.</b>	<ul style="list-style-type: none"> <li>• See if the drive is connected properly to the PC.</li> <li>• See if the device drive program has been installed properly.</li> </ul>
<b>The Window OS can't detect the drive.</b>	<ul style="list-style-type: none"> <li>• See if the device drive program has been installed properly.</li> <li>• Can be an OS problem. Try to reinstall the Windows OS program.</li> </ul>
<b>The system won't read the disc.</b>	<ul style="list-style-type: none"> <li>• See if the system detects the drive.</li> <li>• Make sure you use the types of discs that are supported by the drive.</li> <li>• See if the on/off light turns into green.</li> <li>• Make sure you inserted the disc with the label facing up.</li> <li>• Make sure you are using the right program for disc playback.</li> <li>• See if the disc is clean.</li> <li>• See if any congealing has occurred.</li> <li>• Make sure the region code of the drive matches the disc number.</li> </ul>

You can confirm the use of software at the site of our customer support.

Address: [www.samsungODD.com](http://www.samsungODD.com)

- See " Customer support > Download center > User's manual(PDF) > Software "

- See " Information > Movie manual > Recording software "

**Technical Specifications**

Category		SH-S203B(TS-H653B)/SH-S203D(TS-H653D)	
		DVD Writer	
DISC	Usable Discs	DVD : DVD-R, DVD-RW, DVD+R, DVD+RW, DVD-ROM, DVD-Video, DVD+R(DUAL), DVD-R(DUAL), DVD-RAM	
		C D : CD-ROM, CD-R, CD-RW, CD-DA, CD+EG, CD-MIDI, CD-TEXT, CD-ROM XA, Mixed Mode CD, CD-i, CD-i Bridge (Photo-CD, Video-CD), Multisession CD(Photo-CD, CD-EXTRA, Portfolio)	
Interface Support	Interface Port	S-ATA	
	Burst Transfer Rate	S-ATA 1.5Gbps	
Access time (Random)	CD-ROM	110ms (Random)	
	DVD-ROM	130ms (Random)	
Data Transfer Speed(MAX)	Media type	Write	Read
	DVD+R	CAV20X	CAV16X
	DVD+RW	ZCLV 8X	CAV 12X
	DVD+R DUAL	ZCLV16X	CAV 12X
	DVD-R DUAL	ZCLV12X	CAV 12X
	DVD-R	CAV20X	CAV16X
	DVD-RW	CLV 6X	CAV 12X
	DVD-ROM(Single)	-	CAV16X
	DVD-ROM(Dual)	-	CAV 12X
	CD-ROM	-	CAV48X
	CD-R	PCAV48X	CAV40X
	US-RW	ZCLV32X	CAV40X
	HS-RW	CLV10X	CAV40X
CD-RW	CLV 4X	CAV40X	
DVD-RAM	CAV12X	CAV12X	
<b>Buffer Memory</b>		2MB	
<b>Drive Installation</b>		Horizontal / vertical	
Operating Environment	Temperature	41°F ~ 122°F (5°C ~ 45°C)	
	Humidity	5 ~ 10% (RH)	
<b>Size(Width x Height x Length)</b>		5.34 X 1.65 X 6.69 Inch (148.2 X 42 X 170mm)	
<b>Weight</b>		750 g	

