

ReadyNAS Pro Pioneer Edition User Guide

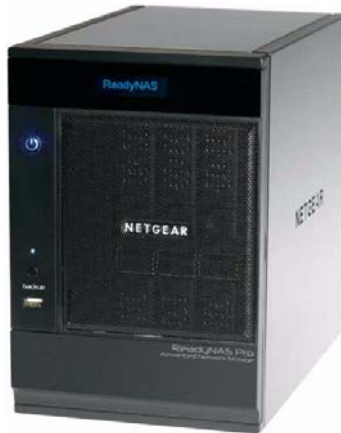

NETGEAR®

NETGEAR, Inc.
350 E Plumeria Drive
San Jose, CA 95134 USA

202-10456-01
v1.0
December 2008

Technical Support

Registration on the website or over the phone is required before you can use our telephone support service. The phone numbers for worldwide regional customer support centers are on the Warranty and Support Information card that came with your product.

Go to <http://kbserver.netgear.com> for product updates and Web support.

Trademarks

NETGEAR, the NETGEAR logo, ReadyNAS, X-RAID, X-RAID2, FrontView, RAIDar, RAIDiator, Network Storage Processor, and NSP are trademarks or registered trademarks of NETGEAR, Inc. Microsoft, Windows, Windows NT and Vista are registered trademarks of Microsoft Corporation. Other brand and product names are registered trademarks or trademarks of their respective holders.

Statement of Conditions

In the interest of improving internal design, operational function, and/or reliability, NETGEAR reserves the right to make changes to the products described in this document without notice.

NETGEAR does not assume any liability that may occur due to the use or application of the product(s) or circuit layout(s) described herein.

Certificate of the Manufacturer/Importer

It is hereby certified that the ReadyNAS Pro Network Attached Storage System Pioneer Edition has been suppressed in accordance with the conditions set out in the BMPT-AmtsblVfg 243/1991 and Vfg 46/1992. The operation of some equipment (for example, test transmitters) in accordance with the regulations may, however, be subject to certain restrictions. Please refer to the notes in the operating instructions.

The Federal Office for Telecommunications Approvals has been notified of the placing of this equipment on the market and has been granted the right to test the series for compliance with the regulations.

Bestätigung des Herstellers/Importeurs

Es wird hiermit bestätigt, daß das ReadyNAS Pro Network Attached Storage System Pioneer Edition gemäß der im BMPT-AmtsblVfg 243/1991 und Vfg 46/1992 aufgeführten Bestimmungen entstört ist. Das vorschriftsmäßige Betreiben einiger Geräte (z.B. Testsender) kann jedoch gewissen Beschränkungen unterliegen. Lesen Sie dazu bitte die Anmerkungen in der Betriebsanleitung.

Das Bundesamt für Zulassungen in der Telekommunikation wurde davon unterrichtet, daß dieses Gerät auf den Markt gebracht wurde und es ist berechtigt, die Serie auf die Erfüllung der Vorschriften hin zu überprüfen.

Voluntary Control Council for Interference (VCCI) Statement

This equipment is in the Class B category (information equipment to be used in a residential area or an adjacent area thereto) and conforms to the standards set by the Voluntary Control Council for Interference by Data Processing Equipment and Electronic Office Machines aimed at preventing radio interference in such residential areas. When used near a radio or TV receiver, it may become the cause of radio interference. Read instructions for correct handling.

Product and Publication Details

Model Number:

Publication Date: December 2008

Product Family: Network Storage

Product Name: ReadyNAS Pro Network Attached Storage System Pioneer Edition

Home or Business Product: Home

Language: English

Publication Part Number: 202-10456-01

Publication Version Number: 1.0

Contents

About This Manual

Conventions, Formats, and Scope	ix
How to Use This Manual	x
How to Print This Manual	x
Revision History	xi

Chapter 1

Getting Acquainted

What is the ReadyNAS Pro?	1-1
What Are the Benefits of X-RAID and X-RAID2?	1-2
X-RAID Is Expandable RAID	1-2
X-RAID2 Is Even More Flexible	1-3
Introducing the Status Displays, Ports, and Drive Bay	1-4
Front and Side Panel	1-4
Drive Bay	1-5
Rear Panel	1-6
Choosing a Location for a ReadyNAS Pro	1-7
Initial Setup	1-7
Default IP Address, Login Name, and Password	1-8
The RAIDar Setup Utility	1-8
The FrontView Management Console	1-9
NETGEAR ReadyNAS Community	1-10

Chapter 2

Setting Up and Managing Your ReadyNAS Pro

Customizing Network Settings	2-1
Ethernet Interfaces	2-2
Global Network Settings	2-4
WINS	2-5
DHCP	2-5
Route: A Manual Routing Table	2-6

Updating the Admin Password	2-6
Selecting Services for Share Access	2-8
Standard File Protocols	2-8
Streaming Services	2-10
Discovery Services	2-11
Understanding Volume Management	2-11
Overview of RAID Levels and X-RAID2	2-12
Volume Management for Flex-RAID	2-14
Volume Management for X-RAID2	2-16
Volume Maintenance	2-17
Working with USB Volumes	2-18
Setting Up Printers	2-20
Print Shares over CIFS/SMB	2-20
IPP Printing	2-21
Managing Print Queues	2-21
Adjusting System Settings	2-22
Clock, System Time, and NTP Options	2-22
Alerts, Alert Contacts, Alert Settings, and SMTP	2-23
Language Settings	2-24
Updating ReadyNAS Pro Pioneer Edition	2-25
Configuration Backup	2-28

Chapter 3
Managing User Access

Understanding Disk Share Security Access	3-1
Setting Up User and Group Accounts	3-2
Managing Groups	3-2
Managing Users	3-4
Setting Accounts Preferences	3-6
Changing User Passwords	3-6
Managing Your Shares	3-6
Adding Shares	3-7
Managing Shares	3-8
Web Browser	3-12
FTP/FTPS	3-14
Rsync	3-15

Networked DVD Players and UPnP AV Media Adapters	3-16
Remote Access	3-16
Remote FTP Access	3-17
Remote HTTP Access	3-18
Chapter 4	
Securing Your Data	
Configuring Backup Jobs	4-1
Adding a New Backup Job	4-1
Viewing the Backup Schedule	4-6
Programming the Backup Button	4-7
Viewing the Backup Log	4-8
Editing a Backup Job	4-8
Backing Up the ReadyNAS to a USB Drive	4-8
Chapter 5	
Optimizing Performance	
Performance	5-1
Adding a UPS to Protect Against Power Failures	5-2
Power Management	5-3
Disk Spin-Down Option	5-3
Power Timer	5-4
UPS Configuration	5-4
Wake-On-LAN	5-4
Chapter 6	
Managing Levels of Service	
Viewing System Status	6-1
Health	6-1
Logs	6-2
Replacing a Failed Disk	6-3
Choosing a Replacement Disk	6-3
Replacing a Failed Disk	6-3
Resynchronizing the Volume	6-5
Using the System Diagnostic Menu	6-5
Use the OS REINSTALL Option to Re-install the Firmware	6-6
Configuring RAID	6-7
Shutdown	6-8

Appendix A
Share Access from MAC and Linux Systems

MAC OS X	A-1
AFP over Bonjour	A-2
AFP over AppleTalk	A-3
MAC OS 9	A-5
Accessing Shares from Linux/Unix	A-7

Appendix B
Related Documents

Index

About This Manual

The *NETGEAR® ReadyNAS Pro Pioneer Edition User Guide* describes how to configure and troubleshoot a ReadyNAS Pro Pioneer Edition system. The information in this manual is intended for readers with intermediate computer and networking skills.

Conventions, Formats, and Scope

The conventions, formats, and scope of this manual are described in the following paragraphs:

- **Typographical Conventions.** This manual uses the following typographical conventions:

<i>Italic</i>	Emphasis, books, CDs, file and server names, extensions
Bold	User input, IP addresses, GUI screen text
Fixed	Command prompts, CLI text, code
<i>italic</i>	URL links

- **Formats.** This manual uses the following formats to highlight special messages:

	Note: This note highlights information of importance or special interest.
---	--

	Tip: This note highlights a procedure that will save time or resources.
---	--

	Warning: This note warns against a malfunction or damage to the equipment.
---	---





	Danger: This safety warning warns against personal injury or death.
---	--

- **Scope.** This manual is written for the ReadyNAS Pro Pioneer Edition according to these specifications:

Product Version	1.0
Manual Publication Date	December 2008

How to Use This Manual

The HTML version of this manual includes the following:

- Buttons,  and , for browsing forward or backward through the manual one page at a time.
- A  button that displays the table of contents and a  button that displays an index. Double-click on a link in the table of contents or index to navigate directly to where the topic is described in the manual.
- A  button to access the full NETGEAR, Inc. online knowledge base for the product model.
- Links to PDF versions of the full manual and individual chapters.

How to Print This Manual

To print this manual, you can choose one of the following options, according to your needs.

- **Printing a page from HTML.** Each page in the HTML version of the manual is dedicated to a major topic. Select File > Print from the browser menu to print the page contents.
- **Printing from PDF.** Your computer must have the free Adobe Acrobat Reader installed for you to view and print PDF files. The Acrobat Reader is available on the Adobe website at <http://www.adobe.com>.
 - **Printing a PDF chapter.** Use the **PDF of This Chapter** link at the top left of any page.
 - Click the **PDF of This Chapter** link at the top left of any page in the chapter you want to print. The PDF version of the chapter you were viewing opens in a browser window.
 - Click the print icon in the upper left corner of your browser window.

- **Printing a PDF version of the complete manual.** Use the **Complete PDF Manual** link at the top left of any page.
 - Click the **Complete PDF Manual** link at the top left of any page in the manual. The PDF version of the complete manual opens in a browser window.
 - Click the print icon in the upper left corner of your browser window.

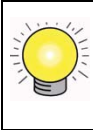

Tip: If your printer supports printing two pages on a single sheet of paper, you can save paper and printer ink by selecting this feature.

Revision History

Part Number	Version Number	Date	Description
202-10456-01	1.0	December 2008	First publication

Chapter 1

Getting Acquainted

This chapter provides an overview of the features and capabilities of the ReadyNAS Pro Pioneer Edition. It also covers the unit's physical features, main software, and initial setup steps.

Topics discussed in this chapter include:

- [“What is the ReadyNAS Pro?”](#)
- [“What Are the Benefits of X-RAID and X-RAID2?”](#)
- [“Introducing the Status Displays, Ports, and Drive Bay”](#)
- [“Choosing a Location for a ReadyNAS Pro”](#)
- [“Initial Setup”](#)
- [“The RAIDar Setup Utility”](#)
- [“The FrontView Management Console”](#)
- [“NETGEAR ReadyNAS Community”](#)

What is the ReadyNAS Pro?

NETGEAR ReadyNAS Pro gigabit network storage products provide small and medium sized businesses with easy-to-use, high-performance network attached storage solutions to share and protect critical data. Housed in a compact desktop form factor, the ReadyNAS Pro products support up to six SATA I or SATA II hard drives via six lockable, hot-swappable disk trays. Three USB 2.0 ports enable the connection of USB drives or printers. Based on current drive capacities, the ReadyNAS Pro provides up to 9TB of network attached storage that can easily be expanded as larger capacity drives become available.

The ReadyNAS Pro enables users across the LAN, WAN, or over the Internet to back up and share data from Windows, Macintosh, and Linux systems. ReadyNAS Pro offers extensible robust high-availability data protection. Its fail-safe features include dual redundant Gigabit Ethernet ports and support for RAID 0, 1, 5, RAID 5 plus hot spare, RAID 6, and NETGEAR's proprietary X-RAID2™ for automatic volume expansion.

In addition to a Web based graphical user interface (GUI) and setup wizard for ease-of-use and setup, ReadyNAS Pro features an LCD display that provides quick and intuitive system status readings and incorporates an active system monitoring capability which continually monitors the

entire system for abnormal situations or part failures and e-mails system alerts to the network administrator. In addition, the Frontview Add-on SDK provides developers the tools for uniquely extending ReadyNAS capabilities. For a full list of what is new compared with existing ReadyNAS systems, see [ReadyNAS Specifications](#) on ReadyNAS.com.

What Are the Benefits of X-RAID and X-RAID2?

Shipping in volume since 2004, X-RAID is a proven patent-pending technology that is available only on ReadyNAS. ReadyNAS Pro introduces X-RAID2, the 2nd generation version of X-RAID.

X-RAID Is Expandable RAID

RAID stands for Redundant Array of Independent Disks, which is a way of protecting your data in case of a disk failure. The X in X-RAID stands for “expandable”; X-RAID is expandable RAID.

X-RAID technology simplifies volume management. What most people want to do with their data volumes over time is either add redundancy or expand them without the headaches usually associated with doing so. By using simple rules, X-RAID hides the complexities yet still provides volume management features previously available only in enterprise-level storage solutions.

X-RAID Simplifies Redundancy

To maintain redundancy from disk failure, X-RAID requires a one-disk overhead. In a two-disk X-RAID volume, the usable capacity is one disk, in a three-disk volume the usable capacity is two disks, in a four-disk volume, the usable capacity is three disks, etc.

No Redundancy with a Single Disk but Easy to Add Disks with X-RAID

Even with RAID, there is no data redundancy with one disk; if that disk fails, your data is lost. If you have a one-disk ReadyNAS and want protection from disk failure, you have to add a 2nd disk that is at least as large as the first. It can be ‘hot-added’ while the ReadyNAS is running.

Whenever you add or replace a disk, the ReadyNAS will initialize it, scanning to make sure the disk is good. Once added, your 2nd disk will synch with the 1st disk. Depending on the disk size, the synch may take anywhere from 30 minutes to several hours. The sync occurs in the background so you can still keep on working with the ReadyNAS during this time.

After the sync completes, your data volume is now redundant, meaning if one of the disks fails, the other disk still contains the data, and thus your data is now fully protected from a disk failure.

The X-RAID Data Volume

X-RAID has one data volume. This volume uses the capacity of the smallest disk from each disk. For instance, if you had one 80 GB disk and two 250 GB disks, only 80 GB from each disk is used in the volume. The leftover space on the 250 GB disks is reclaimed only when the 80 GB disk is replaced with a 250 GB or greater capacity disk. However, as you will see below, X-RAID2 is more flexible in how it handles volume expansion.

Horizontal Expansion (More Disks) vs. Vertical Expansion (Larger Disks)

The process of expanding the number of disks we call horizontal expansion. X-RAID also supports vertical expansion by adding larger disks. With first generation X-RAID, horizontal expansion, the capacity is limited to a multiple of your original disk. As larger or more affordable disks become available, you take advantage of vertical expansion to grow the size of your volume. You can add additional disks of at least the size of the 1st disk. You can add a larger disk, but with the original X-RAID extra space will not be used until all disks are at least that size.

X-RAID supports replacing disks with larger capacity ones while keeping the volume data intact. Simply replace each of your disks one by one with a larger disk. After the init process, the disk will be synchronized to restore data redundancy. Again, this process can take 30 minutes to several hours. Both processes occur in the background, so you can continue using the ReadyNAS as usual.

Once you have done this for all disks in the system, just reboot the ReadyNAS to start the volume expansion which occurs in the background. When the process completes, your data will remain intact, but your data volume capacity will have expanded to a multiple of the your smallest capacity disk. That multiple is the total number of disks minus 1 for redundancy. For example, if your system now has 3 disks, and the smallest is 500 GB, then the volume capacity is 1TB.

The beauty with vertical expansion is that you can keep expanding your volume repeatedly with larger capacity disks, a definite future-proof advantage that you can count on with the ReadyNAS.

X-RAID2 Is Even More Flexible

Now, X-RAID2 will automatically expand when as little as two of your disks have extra capacity. Your data volume can keep growing every time you add a larger disk after that. X-RAID2 lets you do this without reformatting your disks and shuffling your data back and forth. The process occurs in the background, so access to the ReadyNAS Pro Pioneer Edition is not interrupted.

Others may claim that they have “online” RAID expansion just like X-RAID2, but take a closer look and you’ll see it’s just not that simple. Unlike X-RAID2, not only will there be complex RAID migration steps, but they cannot recover from a power loss during the process. With X-RAID2, you can turn off the power as many times as you want during the expansion, and it’ll continue where it left off.

Introducing the Status Displays, Ports, and Drive Bay

This section introduces the ReadyNAS Pro display, ports, and drive bay.

Front and Side Panel

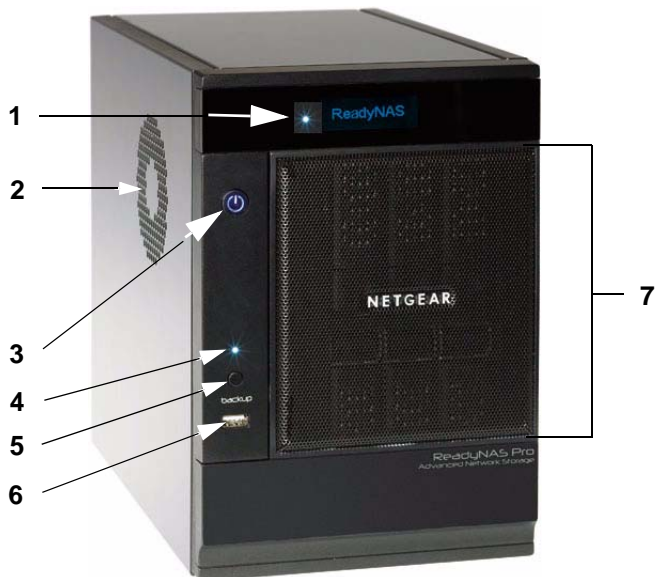

Figure 1-1

1. OLED display, including the disk activity status light



Note: The OLED goes to sleep to prevent burn-in; press the power button to wake it. When reporting an abnormal status, it stays on.

2. CPU exhaust vent
3. Power button/power status
4. USB backup status light
5. Backup button
6. Front USB port
7. Drive bay door

Drive Bay

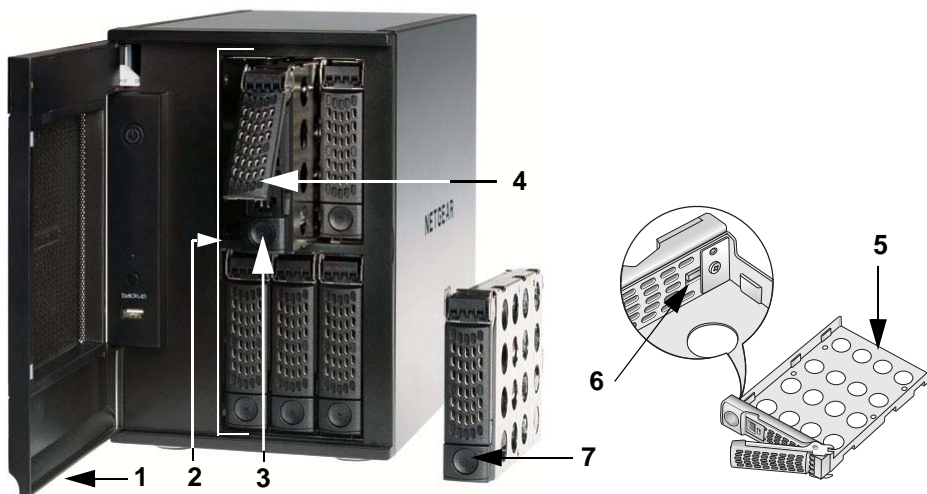



Figure 1-2

1. Drive bay door
2. Six disk bays
3. Disk tray pop-out button
4. Disk tray pop-out latch
5. Disk tray
6. Disk tray lock
7. Recessed disk tray latch lock release

	<p>Note: If you set the tray lock, you will need to use a push-pin or paper clip to open the tray.</p>	
---	---	---

Rear Panel

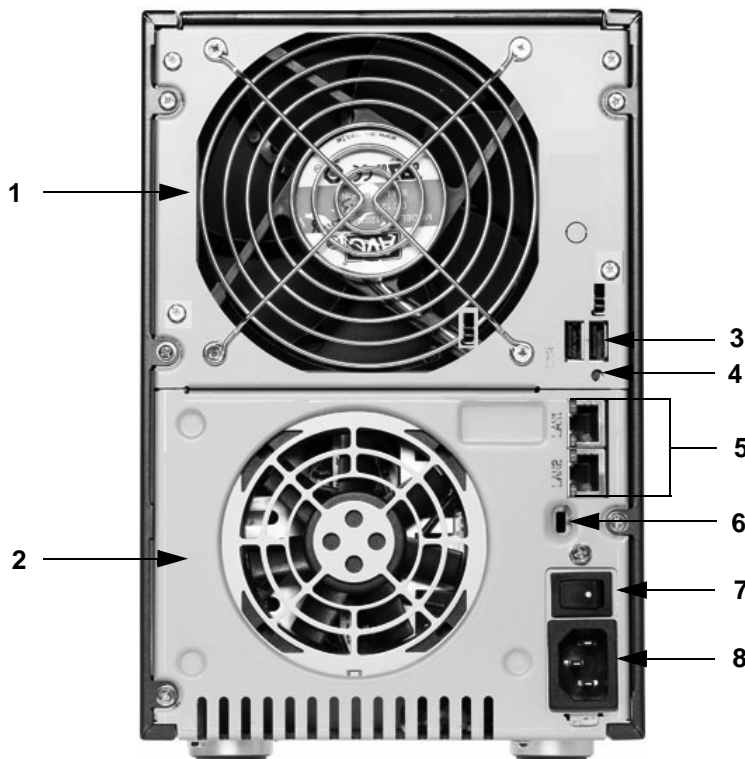

Figure 1-3

1. Disk exhaust fan
2. System exhaust fan
3. Two USB ports
4. Recessed button which provides access to the diagnostic startup menu: Normal, Factory Restore (which erases all data), OS Reinstall, Tech Support remote diagnostics, Skip Volume Check, Memory Test.
5. LAN1 and LAN2 gigabit Ethernet ports
6. Kensington lock to prevent unauthorized removal of the unit
7. Power switch
8. Power cable socket

Choosing a Location for a ReadyNAS Pro

The ReadyNAS Pro is suitable for use in an office environment where it can be free-standing, located in a wiring closet or equipment room.

When deciding where to locate the unite, ensure that:

- It is accessible and cables can be connected easily.
- If it will be protected by an uninterruptable power supply (UPS), its power cable can be securely and safely connected to the UPS.
- Water or moisture cannot enter the case of the unit.
- Airflow around the unit and through the vents in the side of the case is not restricted.
- The air is as free of dust as possible.
- Temperature operating limits are not likely to be exceeded.

Initial Setup

Follow the instructions in the NETGEAR Installation Guide that came with your unit to install your NETGEAR® ReadyNAS™ Pro. An electronic copy of the installation guide is on the product CD, on the NETGEAR web site, and on <http://readynas.com>.

The initial setup estimated completion time is 20 minutes.



Note: A diskless unit requires installing disks and initializing RAID before proceeding. Go to <http://kbserver.netgear.com> for a list of supported disks. Refer to “Configuring RAID” on page 6-7 for instructions on installing disks and configuring RAID.

Refer to [Appendix A, “Share Access from MAC and Linux Systems](#) for instructions on accessing shares from Linux and various versions of the MAC OS.

Default IP Address, Login Name, and Password

The default IP configuration is set to DHCP; if the unit does not get an IP address, it defaults to 192.168.168.168.

The default administrator user name is **admin** with the default password being **netgear1** (case sensitive).



Note: The RAIDar utility includes a discovery mechanism that enables it to find any ReadyNAS on the network without needing to know its IP address. Also, RAIDar does not require a user name and password to access a ReadyNAS.

The RAIDar Setup Utility

The RAIDar utility enables easy setup and management of all your ReadyNAS units.

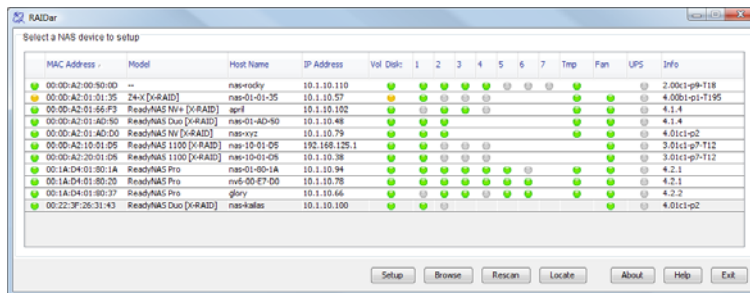

Figure 1-4

It discovers the units in the network, and makes it easy to see the status of the units, and connect to the FrontView management console you use to manage any unit.

The FrontView Management Console

The FrontView management console operates in two modes: Setup Wizard mode, and Advanced Control mode. When the unit is in its factory default state, FrontView is in Setup Wizard mode.

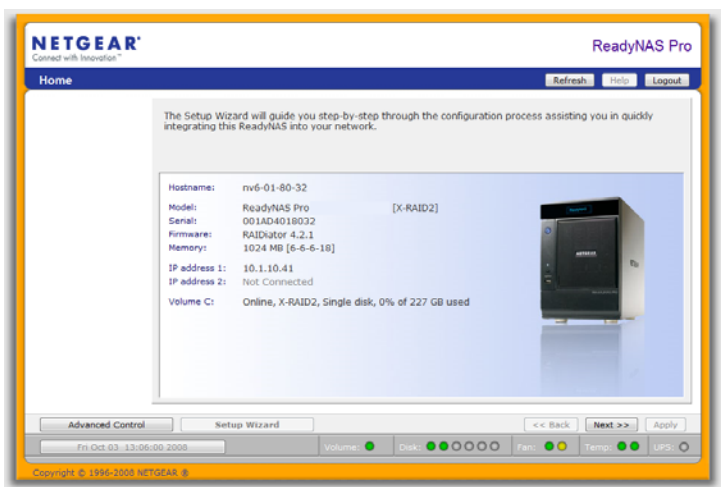

Figure 1-5

Use the wizard to perform the initial configuration of the unit.

The FrontView Advanced Control mode provides access to all the available settings.



Figure 1-6

In this mode, you see the menus on the left that allow you to quickly jump to the screen you want. The bar at the top provides options to return to the Home screen, refresh the browser window, display Help where available, or to log out of this session.



Figure 1-7

At the bottom of the screen is the status bar including the date button on the left which, when clicked takes you to the Clock screen. The status lights to the right give a quick glimpse of the system device status.

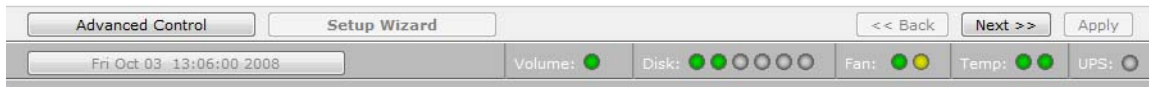

Figure 1-8

Move the mouse pointer over the status light to display device information, or click a status light to display the status in more detail. Above the status lights is the Apply button, which you use to save any changes on the current screen.

NETGEAR ReadyNAS Community

NETGEAR ReadyNAS Community web site is <http://readynas.com>. Find previews and reviews of new features, tutorials, and information you won't get anywhere else. Well, maybe you will, but not easily and not in one happy place like this. Do give us feedback on the ReadyNAS Community Forum and let us know if you would like to see topics not covered here.

Chapter 2

Setting Up and Managing Your ReadyNAS Pro

Setting up and managing the ReadyNAS Pro Network Attached Storage System Pioneer Edition in your network is described in this chapter.

This chapter contains the following sections:

- “Customizing Network Settings”
- “Updating the Admin Password”
- “Selecting Services for Share Access”
- “Understanding Volume Management”
- “Setting Up Printers”
- “Adjusting System Settings”
- “Configuration Backup”

Customizing Network Settings

Access network settings by clicking the Advanced Control button, and selecting Network > from the main menu. From the Network menu, you can then navigate to your basic network settings screens such as Interfaces, Gateway, DNS, WINS, DHCP, and Route options.

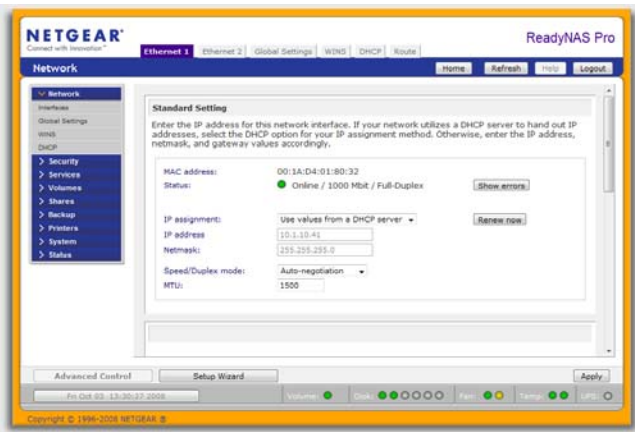
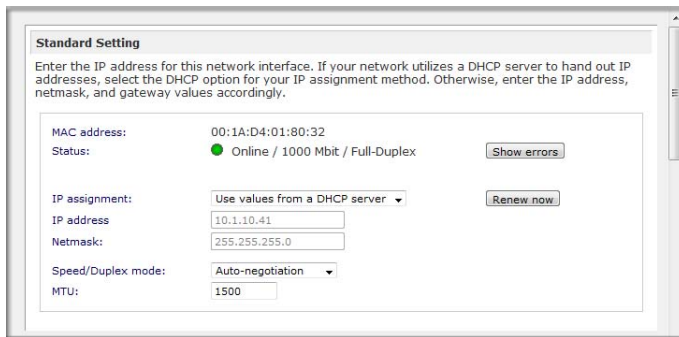

Figure 2-1

Ethernet Interfaces

Select Network > Interfaces > Ethernet 1 /Ethernet 2 tab pages to specify network interface-specific settings for Standard Settings and Performance Settings.

Standard Setting. In this section, you can specify the IP address, network mask, speed/duplex mode, and MTU settings. In most networks where a DHCP server is enabled, you can simply specify the **Use values from a DHCP server** option to automatically set the IP address and network mask.



The screenshot shows a web-based configuration interface titled "Standard Setting". At the top, there is a text box with instructions: "Enter the IP address for this network interface. If your network utilizes a DHCP server to hand out IP addresses, select the DHCP option for your IP assignment method. Otherwise, enter the IP address, netmask, and gateway values accordingly." Below this, the configuration fields are as follows:

- MAC address: 00:1A:D4:01:80:32
- Status: Online / 1000 Mbit / Full-Duplex (with a green dot icon and a "Show errors" button)
- IP assignment: Use values from a DHCP server (dropdown menu, with a "Renew now" button)
- IP address: 10.1.10.41 (text input)
- Netmask: 255.255.255.0 (text input)
- Speed/Duplex mode: Auto-negotiation (dropdown menu)
- MTU: 1500 (text input)

Figure 2-2

- **IP Assignment.** Select either **Use values from a DHCP server** or **Use values below**.
 - If you elect to assign the IP address using **Use values from a DHCP server**, NETGEAR advises that you set the lease time on the DHCP server/router to a value of at least a day. Otherwise, you might notice that the IP address of the unit changes even when it has been powered down for only a few minutes. Most DHCP servers allow you to assign a static IP address for specified MAC addresses. If you have this option, this would be a good way to ensure your ReadyNAS Pro Pioneer Edition maintains the same IP address even in DHCP mode.
 - If you assign a static IP address by selecting **Use values below**, be aware that the browser will lose connection to the ReadyNAS Pro Pioneer Edition device after the IP address has been changed. To reconnect after assigning a static IP address, open RAIDar and click **Rescan** to locate the device, and then reconnect.
- **Speed/Duplex Mode (Only applies to 10/100 connections).** If you have a managed switch that works best if the devices are forced to a particular speed or duplex mode, you can select

the setting you want. NETGEAR advises that you keep the setting in an Auto-negotiation mode otherwise.

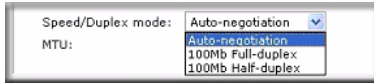

Figure 2-3

- **MTU.** In some network environments, changing the default MTU value can fix throughput problems. NETGEAR advises that you leave the default setting otherwise.

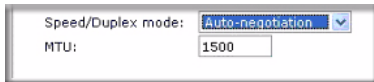

Figure 2-4

Performance Settings . In this section, you can the Enable jumbo frames option allows you to optimize the ReadyNAS Pro Pioneer Edition for large data transfers such as multiple streams of video playback.

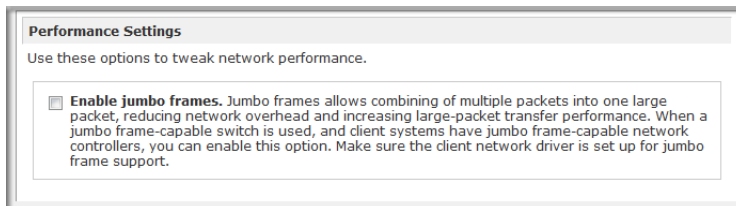

Figure 2-5



Note: Use this option only if your NIC and your gigabit switch support jumbo frames. The ReadyNAS Pro Pioneer Edition supports a 9000 byte frame size. For optimal performance, a switch capable of this frame size or larger should be used.

Global Network Settings

Hostname
The hostname for this device can be used in place of the IP address when accessing this device over CIFS/SMB. This name will also be used in various alerts that this device will send out.
Hostname:

Default Gateway
The default gateway specifies the IP address of the system/router that network requests out of the current subnet will get routed to.
Default gateway:

DNS Settings
DNS, or Domain Name Service, provides a means to translate hostnames to IP addresses. Enter the DNS IP addresses here.
Domain name server 1:
Domain name server 2:
Domain name server 3:
Domain name:

Figure 2-6

Hostname

The Hostname you specify is used to advertise the ReadyNAS Pro Pioneer Edition on your network. You can use the hostname to address the ReadyNAS Pro Pioneer Edition in place of the IP address when accessing the ReadyNAS Pro Pioneer Edition from Windows, or over OS X using SMB. This is also the name that appears in the RAIDar scan list.

The default hostname is **nas-** followed by the last three bytes of your primary MAC address.

Default Gateway

The Default Gateway specifies the IP address of the system where your network traffic is routed if the destination is outside your subnet. In most homes and smaller offices, this is the IP address of the router connected to the cable modem or your DSL service.

If you selected the DHCP option in the Ethernet or Wireless tab, the Default Gateway field is automatically populated with the setting from your DHCP server. If you selected the Static option, you can manually specify the IP addresses of the default gateway server here.

DNS Settings

The DNS area allows you to specify up to three Domain Name Service servers for hostname resolution. The DNS service translates host names into IP addresses.

If you selected the DHCP option in the Ethernet or Wireless tab, the Domain Name Server fields are automatically populated with the DNS settings from your DHCP server. If you selected the

Static option, you can manually specify the IP addresses of the DNS servers and the domain name here.

WINS

The WINS option allows you to specify the IP address of the WINS (Windows Internet Naming Service) server. A WINS server is typically a Windows server on the network that allows the ReadyNAS Pro Pioneer Edition or other devices on the network to be browsed from other subnets.

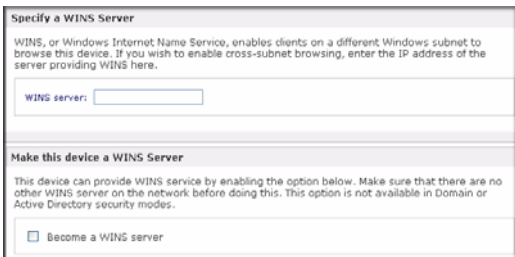

Specify a WINS Server

WINS, or Windows Internet Name Service, enables clients on a different Windows subnet to browse this device. If you wish to enable cross-subnet browsing, enter the IP address of the server providing WINS here.

WINS server:

Make this device a WINS Server

This device can provide WINS service by enabling the option below. Make sure that there are no other WINS servers on the network before doing this. This option is not available in Domain or Active Directory security modes.

Become a WINS server

Figure 2-7

If you do not have an existing WINS server, you can designate the ReadyNAS Pro Pioneer Edition to be one. Simply select the **Become a WINS server** check box, and configure your Windows PC to specify the ReadyNAS Pro Pioneer Edition IP address as the WINS server. This can be useful if you wish to browse by hostname across multiple subnets (for example, over VPN).

DHCP

The DHCP tab allows you to specify this device as a DHCP (Dynamic Host Configuration Protocol) server. DHCP service simplifies management of a network by dynamically assigning IP addresses to new clients on the network.

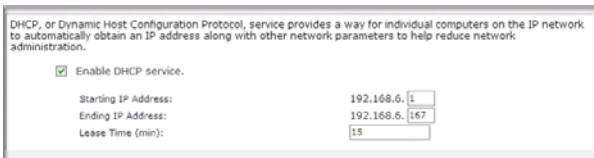

DHCP, or Dynamic Host Configuration Protocol, service provides a way for individual computers on the IP network to automatically obtain an IP address along with other network parameters to help reduce network administration.

Enable DHCP service.

Starting IP Address: 192.168.0.1

Ending IP Address: 192.168.0.167

Lease Time (min): 15

Figure 2-8

Select the **Enable DHCP service** check box if you want the ReadyNAS Pro Pioneer Edition device to act as a DHCP server. This is convenient in networks where DHCP service is not already available.



Note: These options are available only if this device is not already using a DHCP address. Enabling DHCP service on a network already utilizing another DHCP server will result in conflicts. If you wish to use this device as a DHCP server, make sure to specify static addresses in the Ethernet and DNS tabs.

Route: A Manual Routing Table

The Route tab allows you to specify a manual routing table for each Ethernet interface. You can use this option to optimize performance. For example, you could configure a manual routing table to assure that these Ethernet interfaces were directly routed over a fiber backbone to assure that the unit would not experience the traffic congestion that can build up on a gigabit segment.

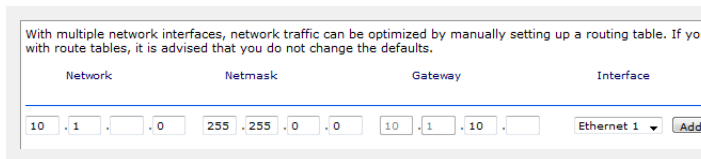

Figure 2-9

Updating the Admin Password

The Security tab allows you to set the administrator password, administer security, and set up the password recovery feature on the ReadyNAS.



Note: The RAIDar utility includes a discovery mechanism that enables it to find any ReadyNAS on the network without needing to know its IP address. Also, RAIDar does not require a user name and password to monitor a ReadyNAS.

The Admin Password tab allows you to change the administrator user password. The administrator user is the only user that can access FrontView, and this user has administrative privileges when accessing shares. Be sure to set a password different from the default password, and make sure that

this password is kept in a safe place. Anyone who obtains this password can change or erase the data on the ReadyNAS.

The screenshot shows the 'Security' menu on the left with options: Admin Password, Security M, User & Gro, Service, Volum, Shares, Backup, Printer, System, and Status. The 'Admin Password' option is selected, leading to a form with the following fields:

- New admin password:
- Retype admin password:
- Password recovery question:
- Password recovery answer:
- Password recovery email address:

A text box above the form reads: "To change the admin password you will need to additionally specify a password recovery question, the expected answer, and an email address. In case you forget the admin password, you can reset the password by answering the password recovery question correctly and specifying the email address where the new admin password will be sent. **There is no other way to recover a lost password without setting the device back to factory default or reinstalling the firmware.**"

The 'Password Recovery' form on the right contains the following fields:

- Enter the password recovery email address and answer the question below. If the input is correct, the admin password will be reset, and the new password will be sent to the admin email address on file.
- Password recovery email address:
- Password recovery question:
- Password recovery answer:
-

Figure 2-10

As a safeguard, you are requested to enter a password recovery question, the expected answer, and an e-mail address. If, in the future, you forget the password, you can go to **https://<ReadyNAS ip_address>/password_recovery**. Successfully answering the questions there resets the Admin Password, which is sent to the e-mail address you enter on this screen.

Selecting Services for Share Access

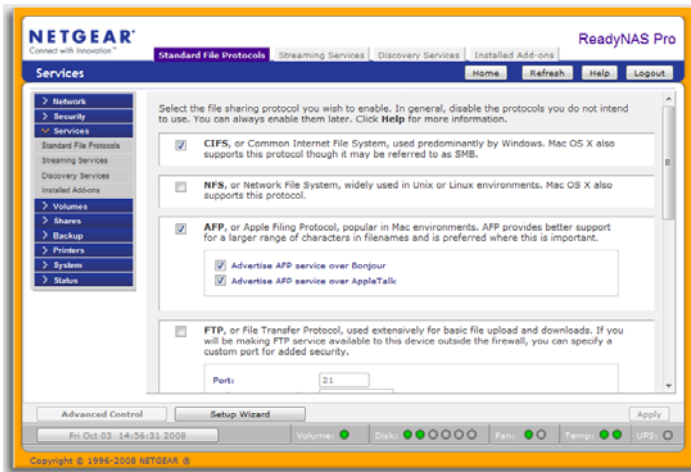

Figure 2-11

The Services screen allows you to manage various services for share access. This in effect controls the type of clients you wish to allow access to the ReadyNAS Pro Pioneer Edition. Three types of services are available: Standard File Protocols, Streaming Services, and Discovery Services. These different services are explained in the following sections.

Standard File Protocols

The standard file protocols are common file-sharing services that allow your workstation clients to transfer files to and from the ReadyNAS Pro Pioneer Edition using built-in file manager-over-network file protocols supported by the client operating system.

The available services are:

- **CIFS** (Common Internet File Service). Sometimes referred to as SMB. This protocol is used mainly by Microsoft Windows clients, and sometimes by Mac OS X clients. Under Windows, when you click on My Network Places Network Neighborhood, you are going across CIFS. This service is enabled by default and cannot be disabled.
- **NFS** (Network File Service). NFS is used by Linux and Unix clients. Mac OS 9/X users can access NFS shares as well through console shell access. The ReadyNAS Pro Pioneer Edition supports NFS v3 over UDP and TCP.

- **AFP** (Apple File Protocol). Mac OS 9 and OS X works best using this protocol as it handles an extensive character set. However, in mixed PC and Mac environments, it is advisable to use CIFS/SMB, unless enhanced character set support is necessary on the Mac. The ReadyNAS Pro Pioneer Edition supports AFP 3.1.
- **FTP** (File Transfer Protocol). Widely used in public file upload and download sites. ReadyNAS Pro Pioneer Edition supports anonymous or user access for FTP clients. If you wish, you can elect to set up port forwarding to nonstandard ports for better security when accessing files over the Internet.
- **HTTP** (Hypertext Transfer Protocol). Used by Web browsers. ReadyNAS Pro Pioneer Edition supports HTTP file manager, allowing Web browsers to read and write to shares using the Web browser. This service can be disabled in lieu of HTTPS to allow for a more secure transmission of passwords and data. With the option to redirect default Web access to a specified share, you can transparently force access to **http://readynas_ip** to **http://readynas_ip/share**. This is useful if you do not want to expose your default share listing page to outsiders. All you need in the target share is an index file such as index.htm or index.html. You have the option of enabling or disabling login authentication to this share.
- **HTTPS** (HTTP with SSL encryption). This service is enabled by default and cannot be disabled. Access to FrontView is strictly through HTTPS for this reason. If you want remote Web access to FrontView or your HTTPS shares, you can specify a nonstandard port (default is 443) that you can forward on your router for better security. You can also regenerate the SSL key based on the hostname or IP address that users will use to address the ReadyNAS Pro Pioneer Edition. This allows you to bypass the default dummy certificate warnings whenever users access the ReadyNAS Pro Pioneer Edition over HTTPS.
- **Rsync**. An extremely popular and efficient form of incremental backup made popular in the Linux platform but now available for various other Unix systems as well as Windows and Mac. Enabling rsync service on the ReadyNAS Pro Pioneer Edition allows clients to use rsync to initiate backups to and from the ReadyNAS Pro Pioneer Edition.

Streaming Services

The built-in streaming services on the ReadyNAS Pro Pioneer Edition allow you to stream multimedia content directly from the ReadyNAS, without the need to have your PC or Mac powered on.

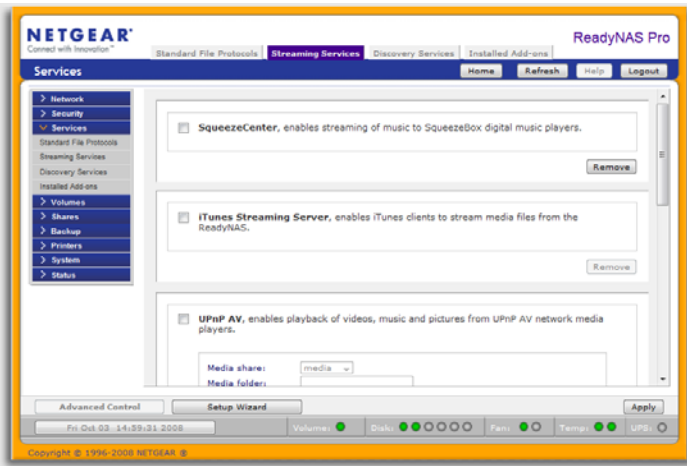

Figure 2-12

- **SqueezeCenter** provides music streaming to the popular Squeezebox music players from Slim Devices. You can click the http setup link for more detailed configuration options.
- **iTunes Streaming Server** enables iTunes clients to stream media files straight from the ReadyNAS Pro Pioneer Edition. You can click the http setup link for more detailed configuration options.
- **UPnP AV** provides media streaming service to stand-alone networked home media adapters and networked DVD players that support the UPnP AV protocol or are Digital Living Network Alliance (DLNA) standard compliant. The ReadyNAS Pro Pioneer Edition comes with a reserved media share that is advertised and recognized by the players. Simply copy your media files to the Videos, Music, and Pictures folders in that share to display them on your player. If you wish, you can specify a different media path where your files reside.
- **Home Media Streaming Server** provides streaming of videos, music, and pictures to popular networked DVD players. The streaming players often utilize the streaming client developed by Syabas. Similar to UPnP AV, this service is used to stream videos, music, and pictures from the reserved media share to these adapters. If you wish to change the location where the media files are stored, you can specify a different share and folder path. Note that this path is shared between the UPnP AV and this service.

Discovery Services

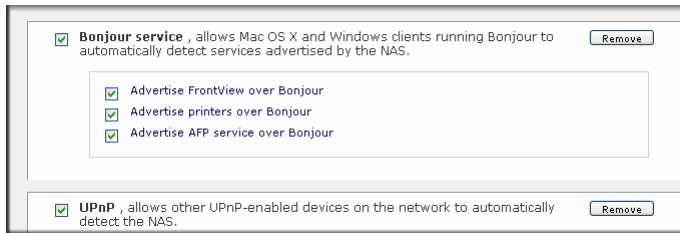

Figure 2-13

- **Bonjour service** provides a simple way of discovering various services on the ReadyNAS Pro Pioneer Edition. Bonjour currently provides an easy way to connect to FrontView, IPP printing, and AFP services. OS X has built-in Bonjour support, and you can download Bonjour for Windows from Apple's website.
- **UPnP** provides a means for UPnP-enabled clients to discover the ReadyNAS Pro Pioneer Edition on your LAN.

Understanding Volume Management

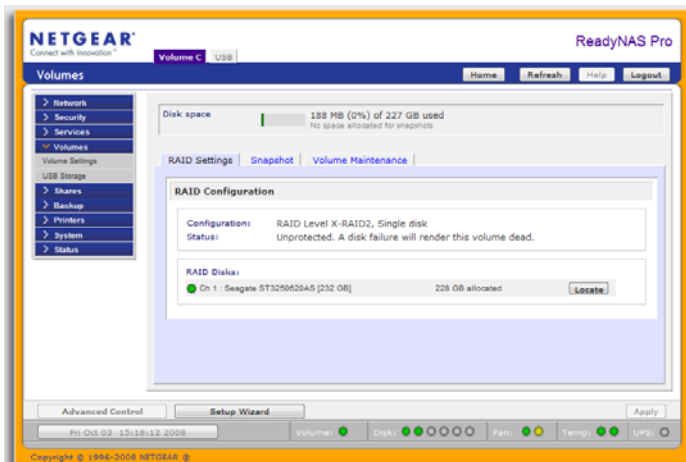

Figure 2-14

The ReadyNAS Pro Pioneer Edition family offers two RAID volume technologies: Flex-RAID, utilizing the industry-standard RAID levels 0, 1, 5, and 6; and X-RAID2, NETGEAR-patented

expandable RAID technology. Your system comes preconfigured with X-RAID2. However, you can switch between the two modes through a factory default reset process described in [“Configuring RAID”](#) on page 6-7.”

Overview of RAID Levels and X-RAID2

This section provides a basic overview of RAID and X-RAID2. RAID is an acronym for Redundant Array of Independent Disks. It can store data in a way that writes extra data derived from the original data across the array organized so that the failure of one (sometimes more) disks in the array will not result in loss of data. A RAID level determines how data is kept redundant. The most popular ones being levels 0, 1, 5, and 6. RAID 0 does not provide redundancy. Also, RAID arrays can be faster to write to and read from than a single disk. These various approaches entail different trade offs of protection against data loss, capacity, and speed.

RAID 0

RAID 0 (striped disks) distributes data across several disks in a way that gives improved speed and full capacity, but all data on all disks will be lost if any one disk fails

RAID 1

RAID 1 (mirrored disks) could be described as a backup solution, using two or more disks that each store the same data so that data is not lost as long as one disk survives.

For example, a two-disk RAID 1 volume can sustain a one-disk failure and continue running. A three-disk RAID 1 volume can sustain up to two disk failures. If a disk fails, the data is retrieved from the surviving disk. Unfortunately, RAID 1 capacity utilization is not optimal in a configuration of three or more disks. The capacity is limited to the size of the smallest disk in the RAID set.

RAID 5

RAID 5 (striped disks with parity) provides the best balance of capacity and performance while providing data redundancy. It combines three or more disks in a way that protects data against loss of any one disk; the storage capacity of the array is reduced by one disk.

RAID 5 provides redundancy by striping data across three or more disks and keeping the parity information on one of the disks in each stripe. In case of disk failure, the surviving disks and the parity disk are used to reconstruct the lost data, providing data transparently to the user application. When the failed disk has been replaced with a good disk, the reconstructed data is written out to the new disk; when the reconstruction (or sometimes referred as RESYNC) process is complete, the volume returns to a redundant state. The capacity of a RAID 5 volume is the

smallest disk in the RAID set multiplied by one less than the number of disks in the RAID set. For example, a four-disk RAID 5 set provides the capacity of three disks, assuming all four disks are identical in size.

RAID 6

RAID 6 (striped disks with dual distributed parity) provides fault tolerance from two drive failures. This makes larger RAID groups more practical, especially for high availability systems. This becomes increasingly important because large-capacity drives lengthen the time needed to recover from the failure of a single drive. Single parity RAID levels are vulnerable to data loss until the failed drive is rebuilt: the larger the drive, the longer the rebuild will take. Dual parity gives time to rebuild the array without the data being at risk if one drive, but no more, fails before the rebuild is complete.

X-RAID2

X-RAID2 is similar to RAID level 5, as it is optimized for large sequential access for the best possible media streaming performance. With a one-disk X-RAID2 volume, the volume is non-redundant and has the capacity of the single disk. By adding a second disk, the capacity remains the same, but the data is now mirrored between the two disks.

X-RAID2 will automatically expand when as little as two of your disks have extra capacity. Your data volume can keep growing every time you add a larger disk after that. It's as simple as that. X-RAID2 lets you do this without reformatting your disks and shuffling your data back and forth. The process occurs in the background, so access to the ReadyNAS Pro Pioneer Edition is not interrupted.

There are advantages to both technologies.

- **Flex-RAID:**
 - The default volume can be deleted and re-created.
 - Hot spare disk is supported.
 - Full volume management is available. You can create RAID level 0, 1, 5, or 6 volumes, specify the volume size, delete a disk from a volume, assign a hot spare, and so on.
 - Multiple volumes are supported, each with a different RAID level.
 - Each disk can be replaced, one by one, then rebuilt; after the last disk is replaced, another data volume using the newly added capacity can be configured.

- **X-RAID2:**

- One-volume technology, but supports volume expansion, either with the addition of more disks or the replacement of an existing disk with larger capacity disks.
- You can start out with one disk, and add more disks as you need them or can afford them.
- Volume management is automatic. Add a second disk, and it becomes a mirror to the first. Add a third disk and your capacity doubles; add a fourth, and your capacity triples, and so on up to a fifth—the expansion occurring while redundancy is maintained.
- In the future, you will be able to replace disks, one at a time, have each one finish rebuilding and, after new redundant space becomes available, your volume will automatically expand to utilize the new capacity.

Volume Management for Flex-RAID

If you want to reconfigure the default volume C, split it into multiple volumes, or specify a different RAID level, you need to reconfigure your volume. The first step is to delete the existing volume you want to replace.

Deleting a Volume

To delete a volume, select the **Volume** tab of the volume you wish to delete (if there are multiple volumes) and click **Delete Volume** (in this case only **Volume C** is configured).



Warning: Make sure that you back up the files you wish to keep before deleting a volume. All shares files residing on that volume *will be deleted and non-recoverable!*

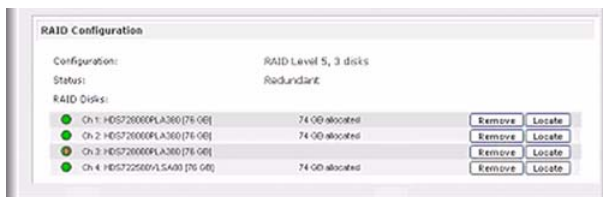

Figure 2-15

You are asked to confirm your intention by typing **DELETE VOLUME**.

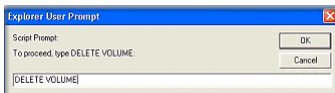

Figure 2-16

Adding a Volume

After deleting the volume, Add Volume tab displays listing the available configurable space on the hard disks. All the disks are selected by default. You can elect to specify a hot spare disk if you wish. A hot spare remains in standby mode and automatically regenerates the data from a failed disk from the volume. A hot spare disk is available for RAID level 1 and RAID level 5 only if there are enough disks to fulfill the required minimum plus one.

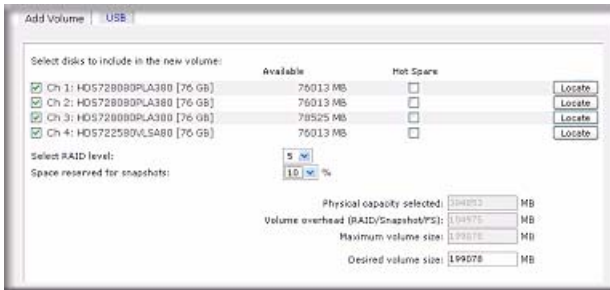

Figure 2-17

To add a volume:

1. Select the hard disks. In this example, we select the first three disks and elect not to specify any of them as a hot spare.
2. Select the RAID level. RAID level determines how the redundancy, capacity utilization, and performance are implemented for the volume. Typically in a configuration of three or more disks, RAID level 5 is recommended.

In our example, we selected RAID level 5 for the three selected disks.

3. Specify the desired volume size. After you specify the volume parameters, enter the appropriate volume size—if you wish to configure a smaller volume size than the maximum displayed. The resulting volume will be approximately the size that is specified.

In our example, we kept the maximum size that was calculated.

4. Click **Apply**, and wait for the instruction to reboot the system. It typically takes about 1 minute before you are notified to reboot.

After rebooting, you are notified by e-mail when the volume has been added. Use RAIDar to reconnect to the NAS device.

RAID Settings

After you have added a volume, you can return to the Volume tab and click the RAID Settings tab to display the current RAID information and configuration options for the volume.

Notice that the disk on Channel 4 that we did not configure is listed in the Available Disks section. We can add this disk as a hot spare by clicking **Make hot spare**.

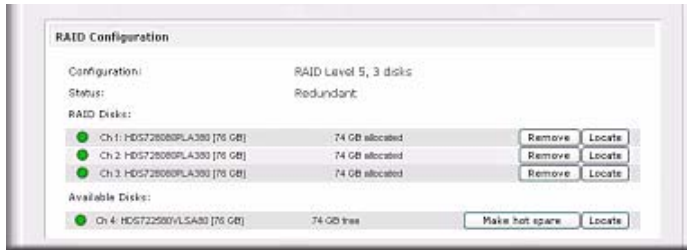



Figure 2-18

We can also remove a disk from the volume by clicking **Remove**. The volume will still be available but in a non-redundant state. An additional disk failure would render this volume unusable.

	Note: The Remove operation is a maintenance feature. NETGEAR recommends that you do not use it in a live environment. Its function is equivalent to hot-removing the disk or simulating a disk failure.
---	--

The Locate option is a way to verify that a disk is correctly situated in the expected disk slot. Clicking **Locate** causes disk LED to blink for 15 seconds.

Volume Management for X-RAID2

Most people want to either add redundancy or expand their data volume. X-RAID2 enables this without the headaches usually associated with doing so.

Adding a Second Disk for Redundancy

A one-disk X-RAID2 device has no redundancy and provides no protection from a disk failure. However, if and when you feel the need for redundancy, simply add a new disk with at least the capacity of the first disk. Depending on the size of the disk, within a few hours, your data volume will be fully redundant. The process occurs in the background, so access to the ReadyNAS Pro Pioneer Edition is not interrupted.

Adding More Disks

At a certain point, you will want more capacity. With typical RAID volumes, you have to back up your data to another system (with enough space), add a new disk, reformat your RAID volume, and restore your data back to the new RAID volume.

Not so with X-RAID2. Simply add the third disk using the ReadyNAS hot-swap trays. If you are adding multiple disks at the same time, or if your ReadyNAS is not hot-swap capable, power down the ReadyNAS, add the disk(s), and power back on. The X-RAID2 device initializes and scans the newly added disk(s) for bad sectors in the background. You can continue working normally without any lag in performance. When the process finishes, you will be alerted by e-mail to reboot the device.

During the boot process, your data volume will be expanded. This process typically takes about 15 to 30 minutes per disk to several hours or longer, depending on the size of your disks, or the quantity of data on your volume. A 250 GB disk takes approximately 30 minutes. Access to the ReadyNAS is not permitted during this time. You will be notified by e-mail when the process is complete.

After you receive your e-mail, the ReadyNAS Pro Pioneer Edition will have been expanded with the capacity from your new disk(s).

Replacing All Your Disks for More Capacity

When you need more disk space and 2 TB disks are available at an attractive price, you can expand your volume capacity by replacing the existing disks. Keep in mind that you must power down several times to replace out your old disks.

First, power down the ReadyNAS Pro, replace the first disk with the large-capacity disk, and then reboot. If your ReadyNAS supports hot-swapping, you can hot-swap the disk without powering down. The ReadyNAS Pro will detect that a new disk was put in place and resynchronizes the disk with data from the removed disk. This process takes an hour or longer, depending on disk capacity, and you can use the ReadyNAS while the new disk synchronizes. Upon completion, replace the second disk with another large-capacity disk, allow that disk to sync, and reboot. You can expand to additional disks by doing the same thing as the 2nd disk: replace with a larger disk, allow the disk to sync, and reboot.

Volume Maintenance

ReadyNAS Pro Pioneer Edition includes a volume maintenance features called disk scrubbing with auto parity fix.

Disk Scrubbing with Auto Parity Fix

This option can detect and correct potential data corruption. Schedule this feature to run in off-peak usage periods.

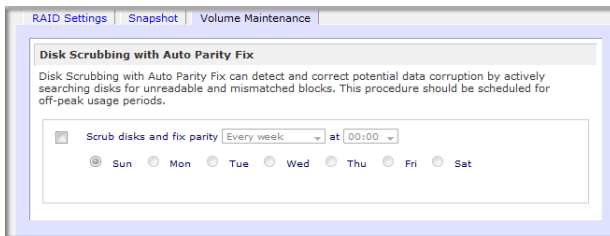

Figure 2-19

You can switch between X-RAID2 and Flex-X-RAID modes. The process involves setting the ReadyNAS Pro Pioneer Edition to the factory default and using RAIDar to configure the volume during a 10-minute delay window during boot. See “[Configuring RAID](#)” on page 6-7 for more information.

Working with USB Volumes

USB storage devices are shared using the name of the device appended with the partition number. You can change the base device name in Volumes > USB Storage, if you want.

The USB tab displays the USB disk and flash devices connected to the ReadyNAS Pro Pioneer Edition, and offers various options for these devices. A flash device appears as **USB_FLASH_1** and a disk device appears as **USB_HDD_1**. If you have multiple devices, they appear appended by an increasing device number; for example, **USB_HDD_2**. If the device contains multiple partitions, the partitions are listed beneath the main device entry.

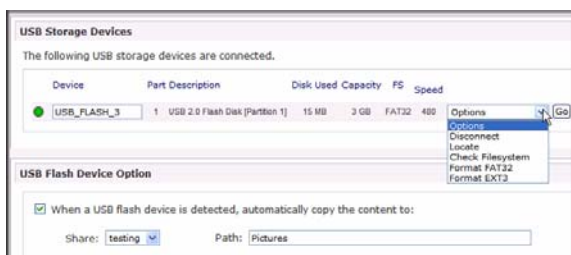

Figure 2-20

Partitions on the storage devices must be one of the following file system formats: FAT32, NTFS, Ext2, or Ext3.

To the right of the access icons are command options. The following commands are available:

Disconnect	This option prepares the USB partition for disconnection by correctly unmounting the file system. In most cases, you can safely disconnect the device without first unmounting; however, the Disconnect command ensures that any data still in the write cache is written out to the disks and that the file system is properly closed. The Disconnect option unmounts all partitions on the device. Once disconnected, physically remove and re-connect to the ReadyNAS to regain access the USB device,.
Locate	In cases where you attach multiple storage devices and wish to determine which device corresponds to the device listing, the Locate command causes the device LED to blink, if present.
Format FAT32	This option formats the device as a FAT32 file system. FAT32 format is easily recognizable by most newer Windows, Linux, and Unix operating systems.
Format EXT3	This option formats the device as an EXT3 file system. Select this option if you will be accessing the USB device mainly from Linux systems or ReadyNAS devices. The advantage of EXT3 over FAT32 is that file ownership and mode information can be retained using this format, whereas this capability is not there with FAT32. Although not natively present in the base operating system, Ext3 support for Windows and OS X can be added. The installation images can be downloaded from the Web.

When the USB device is unmounted, you have the option of renaming it. The next time the same device is connected, it will use the new name rather than the default **USB_FLASH_n** or **USB_HDD_n** naming scheme.

The USB storage shares are listed in the Share screen, and access restrictions can be specified there. The share names reflect the USB device names.

USB Flash Device Option

Toward the lower portion of the USB Storage screen is the USB Flash Device Option section (see [Figure 2-20 on page 2-18](#)). There, you can elect to copy the content of a USB flash device automatically on connection to a specified share. Files are copied into a unique timestamp folder to prevent overwriting previous contents. This is useful for uploading pictures from digital cameras and music from MP3 players without needing to power on a PC.

An additional option to set the ownership of the copied files is available.

USB Volume Name and Access Rights Persistence Across Mount/Dismounts

The ReadyNAS Pro Pioneer Edition attempts to remember the name as long as there is a unique ID associated with the USB device so that the next time the device is connected, the same share name(s) will be available. Share access restrictions are not saved across disconnects, however.



Figure 2-21



Note: Even when access authorization is based on user login, files on a USB device, are saved with UID 0 regardless of the user account. This is to allow easy sharing of the USB device with other ReadyNAS and PC systems.

Setting Up Printers

The ReadyNAS Pro Pioneer Edition device supports automatic recognition of USB printers. If you have not already done so, you can connect a printer now, wait a few seconds, and click **Refresh** to display detected printers. The print share name automatically reflects the manufacturer and model of your printer and is listed in the USB Printers section of the Print Queue service screen.

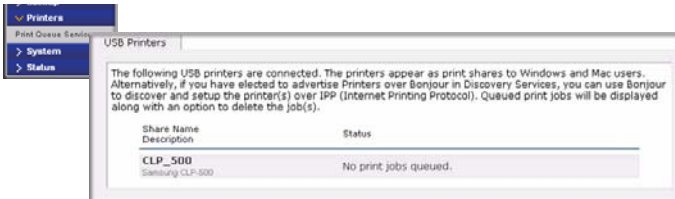

Figure 2-22

Print Shares over CIFS/SMB

The ReadyNAS Pro Pioneer Edition can act as a print server for up to two USB printers for your Windows or Mac clients.

To set up a printer in Windows:

1. Click **Browse** in RAIDar or simply enter `\\hostname` in the Windows Explorer address bar to list all data and printer shares on the ReadyNAS Pro Pioneer Edition.

2. Double-click the printer icon to assign a Windows driver..



Figure 2-23

IPP Printing

The ReadyNAS Pro Pioneer Edition also supports the IETF standard Internet Printing Protocol (IPP) over HTTP. Any client supporting IPP printing (IPP is available natively on the latest Windows XP OS and OS X) can now use this protocol to utilize printers connected to the ReadyNAS Pro Pioneer Edition. The simplest way to utilize IPP printing is to use Bonjour to discover and set up the print queue. Bonjour is built into OS X and can be installed on Windows computers (Bonjour for Windows is available for download from the Apple website at <http://www.apple.com/macosx/features/bonjour/>).

Managing Print Queues

From time to time, printers might run out of ink or paper, or simply jam up, forcing you to deal with the print jobs stuck in a queue. The ReadyNAS Pro Pioneer Edition has a built-in print queue management to handle this. Simply select the USB Printers tab or click **Refresh** to display the printers and the jobs queued up for any “stuck” printers.

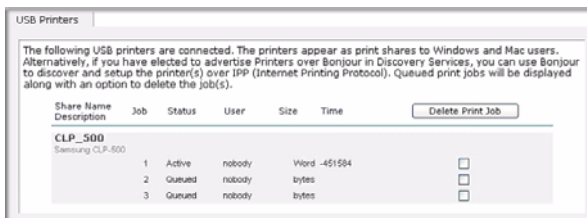

Figure 2-24

Select the radio button next to the print job and click **Delete Print Job** to remove a job (or all jobs) from the print queue.

Adjusting System Settings

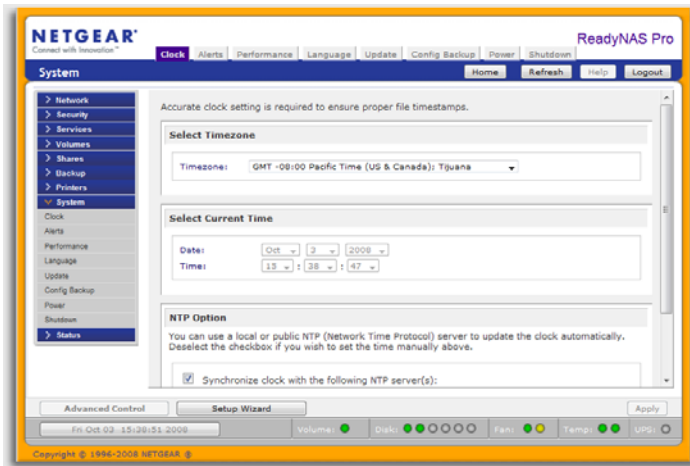

Figure 2-25

System settings include clock, alert, performance, language, firmware update, configuration backup/restore, power, and shutdown settings.

Clock, System Time, and NTP Options

An accurate time setting on the Clock screen is required to ensure proper file timestamps. You can access the Clock screen by selecting System > Clock from the main menu.

The Select Timezone section and the Select Current Time section of the Clock screen allow you to set the Timezone, and the Date and Time. You can elect to synchronize the system time on the device with a remote NTP (Network Time Protocol) server. You can elect to keep the default servers or enter up to two NTP servers closer to your locale. You can find an available public NTP servers by searching the Web.

Alerts, Alert Contacts, Alert Settings, and SMTP



Figure 2-26

In the event of a device or an enclosure failure, a quota violation, low-disk space warning, and other system events requiring your attention, e-mail alerts are sent. The Alerts screen is accessed by selecting System > Alerts from the main menu.

Contacts. The Contacts tab allows you to specify up to three e-mail addresses where system alerts will be sent. The ReadyNAS Pro Pioneer Edition device has a robust system monitoring feature and sends e-mail alerts if something appears to be wrong or when a device has failed. Make sure to enter a primary e-mail address and a backup one if possible.

Some e-mail addresses can be tied to a mobile phone. This is a great way to monitor the device when you are away from your desk.

Settings. This ReadyNAS Pro Pioneer Edition device has been preconfigured with mandatory and optional alerts for various system device warnings and failures. The Settings tab allows you to control the settings for the optional alerts.

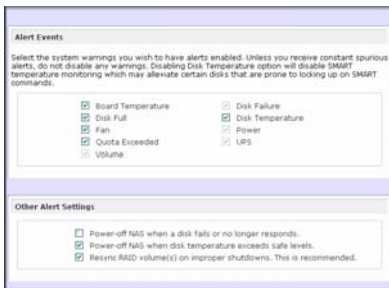

Figure 2-27

You should keep all alerts enabled; however, you might choose to disable an alert if you are aware of a problem and wish to temporarily disable it.

At the bottom of the screen in the Other Alert Settings section, there are a couple of additional options of note. Selecting the **Power-off NAS when a disk fails or no longer responds** option gracefully powers off the ReadyNAS Pro Pioneer Edition if a disk failure or a disk remove event is

detected. Selecting the **Power-off NAS when disk temperature exceeds safe level** gracefully powers off the ReadyNAS Pro Pioneer Edition when the disk temperature exceeds the nominal range.

SMTP. The ReadyNAS Pro Pioneer Edition device has a built-in e-mail message transfer agent (MTA) that is set up to send alert e-mail messages from the device. Some corporate environments, however, might have a firewall that blocks untrusted MTAs from sending out messages.

If you were unable to receive the test message from the Alerts Settings tab, it might have been blocked by the firewall. In that case, specify an appropriate SMTP server in this tab.



Figure 2-28

Internet Service Providers (ISPs) for home might also block untrusted MTAs. Furthermore, they might allow you to specify their SMTP server but requires that you enter a user login and password to send out e-mail—this is common with most DSL services. If this is the case, simply enter the user name and password in the fields provided.

Language Settings

The Language Setting screen offers the option of setting the ReadyNAS Pro Pioneer Edition device to the appropriate character set for file names.

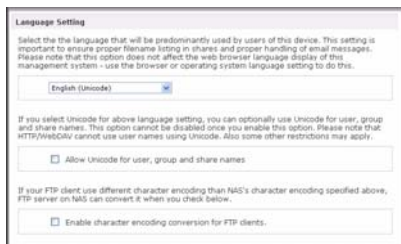

Figure 2-29

For example, selecting Japanese allows you to share files with Japanese names in Windows Explorer.



Figure 2-30

It is best to select the appropriate language based on the region where the device will be operated.



Note: This option does not set the web browser language display—browser settings must be done using the browser language option.

If you wish, you can select the **Allow Unicode for user, group and share names** check box to allow for greater flexibility in non-English speaking regions. This option, once selected, cannot be reversed.



Note: HTTP and WebDAV access do not work with Unicode user names. Other restrictions might exist.

If your FTP client uses different character encoding from the NAS character encoding specified in Unicode, the NAS FTP server will convert it if you select the **Enable character encoding conversion for FTP clients** check box.

Updating ReadyNAS Pro Pioneer Edition

The ReadyNAS Pro Pioneer Edition device offers the option of upgrading the operating firmware either automatically using the Remote Update option or by manually loading an update image downloaded from the NETGEAR Support website.

Updating from the NETGEAR Web Site

The preferred and quicker method if the ReadyNAS Pro Pioneer Edition has Internet access is the Remote update option. Select Update from the main menu and then select the Remote tab. Click **Check for Updates** to check for updates on the NETGEAR update server.

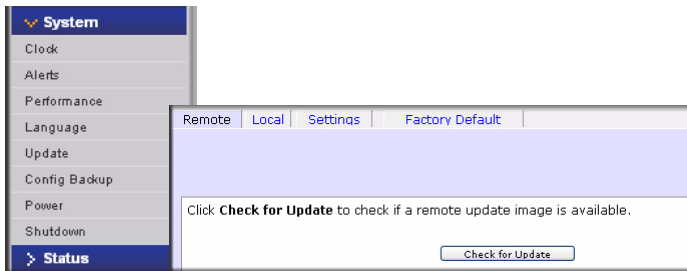

Figure 2-31

If you wish to continue, click **Perform System Update**. After the update image has been downloaded, you will be asked to reboot the system. The update process updates only the firmware image and does not modify your data volume. However, it is always a good idea to back up your important data whenever you perform an update.

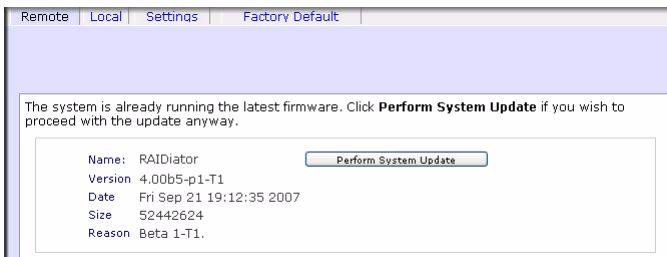

Figure 2-32

Updating from a Local Drive

When the ReadyNAS Pro Pioneer Edition device is not connected to the Internet, or Internet access is blocked, you can download an update file from the Support site and upload that file to the

ReadyNAS Pro Pioneer Edition by selecting the Local update tab. The update file can be a RAIDiator firmware image or an add-on package.

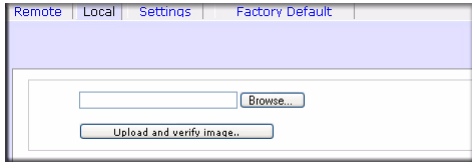

Figure 2-33

Click **Browse** to select the update file and then click **Upload and verify image**. The process takes several minutes after which you are requested to reboot the system and proceed with the upgrade.



Warning: *Do not* click the browser Refresh button during the update process.

Configuring Automatic Update Settings

If you do have a reliable Internet connection, you can enable the automatic update check and download options in the Settings tab.

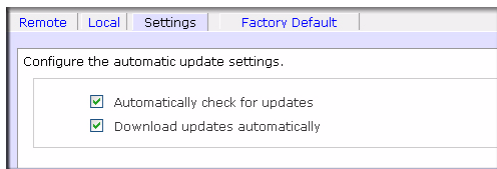

Figure 2-34

If you select the **Automatically check for updates** check box, the ReadyNAS Pro Pioneer Edition does not download the actual firmware update, but notifies you when an update is available. If you select the **Download updates automatically** check box, the update image is downloaded, and you are notified by e-mail to reboot the device to perform the update.

Restoring the Factory Default Settings

The Factory Default tab allows you to reset the ReadyNAS Pro Pioneer Edition device back to its factory default state. Choose this option carefully as **All Data Will Be Lost** unless you back up any data that you wish to keep prior to clicking **Perform Factory Default**.

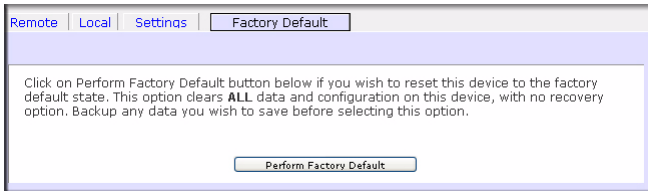

Figure 2-35

If you select this option, you are asked to confirm the command by typing: **FACTORY**.



Warning: Resetting to Factory Default erases everything, including data shares, volume(s), user and group accounts, and configuration information. There is no way to recover after you confirm this command.

Configuration Backup

Backup and restore ReadyNAS configurations to preserve settings to safeguard the configurations or to replicate settings onto other ReadyNAS devices.

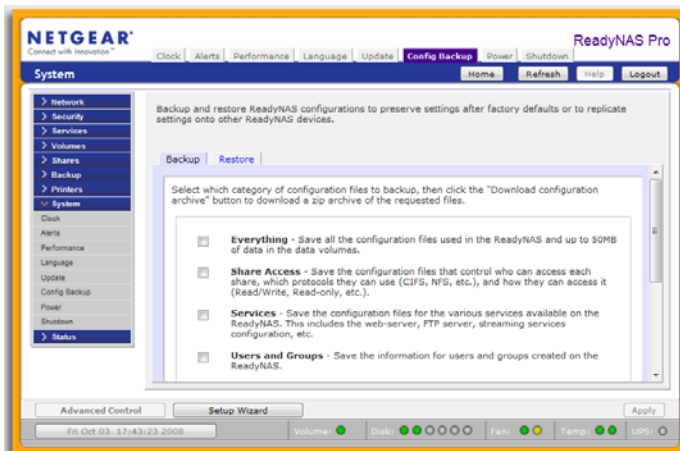

Figure 2-36

Click **Backup** then Select which category of configuration files to backup, then click the “Download configuration archive” button to download a zip archive of the requested files.



Tip: Use the configuration backup to save your configuration so that if you ever have to reset the unit to its factory default settings, you can simply restore all your settings from the configuration backup.

Use the Restore tab to brows for a configuration backup you would like to restore.

Chapter 3

Managing User Access

Setting up and managing the ReadyNAS Pro Network Attached Storage System Pioneer Edition in your network is described in this chapter.

This chapter contains the following sections:

- [“Understanding Disk Share Security Access](#)
- [“Setting Up User and Group Accounts](#)
- [“Changing User Passwords](#)
- [“Managing Your Shares](#)
- [“Web Browser](#)
- [“FTP/FTPS](#)
- [“Rsync](#)
- [“Networked DVD Players and UPnP AV Media Adapters](#)

Understanding Disk Share Security Access

The ReadyNAS Pro Pioneer Edition allows you to limit user and group accounts share access.

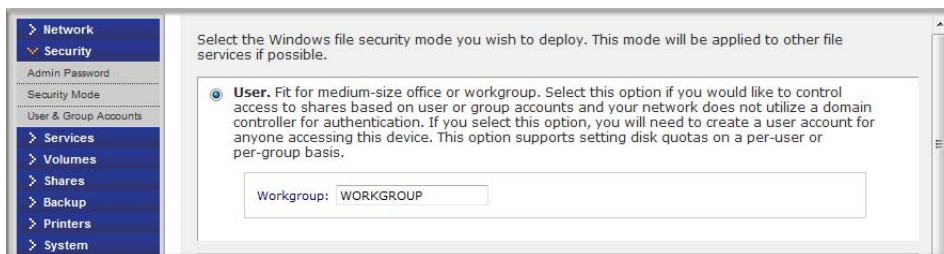

Figure 3-1

Access to shares requires proper login authentication, and you can specify which users and/or groups you wish to offer access. For example, you might want to restrict company financial data to just users belonging to one particular group. The administrator needs to set up and maintain user and group accounts on the network storage device itself. In addition, each user account is automatically set up with a private home share on the network storage.

You specify a workgroup name, and create user and group accounts. You have control over how much disk space is allocated for each user or group.

Each user is given a home share on the ReadyNAS Pro Pioneer Edition device that the user can use to keep private data such as backups of the user's PC. This home share is accessible only by that user and the administrator in order to perform backups of the private shares. The option to automatically generate the private home share is controlled in the Accounts/Preferences tab, and you can disable it if you wish.



Note: Private user shares are accessible only by users using CIFS (Windows) or AppleTalk file protocols.

Setting Up User and Group Accounts

In **User & Group Accounts**, the **Accounts** tab screen allows you to manage user and group accounts on the ReadyNAS Pro Pioneer Edition.

Managing Groups

To add a new group:

1. Select **Manage Groups** from the drop-down menu in the upper right corner.
2. Select the **Add Group** tab if it is not already selected. You can add up to five groups at a time. If you expect to have just one big set of users for one group, you can forego adding a new group and accept the default users group.
3. Click **Apply** to save your settings.

If you want, a user can belong to multiple groups. Once you have created user accounts, you can specify secondary groups that the user can belong to. This allows for finer-grain settings for share access. For instance, you can have user Joe in the Marketing group also belong to the Sales group so Joe can access shares restricted to only the Marketing and Sales groups.

While adding a new group, you can specify the amount of disk space you wish to allocate that group by setting a disk quota. A value of 0 denotes no limit. You can also set the Group ID, or GID, of the group that you are adding. You can leave this field blank and let the system automatically assign this value unless you wish to match your GID to your NFS clients.

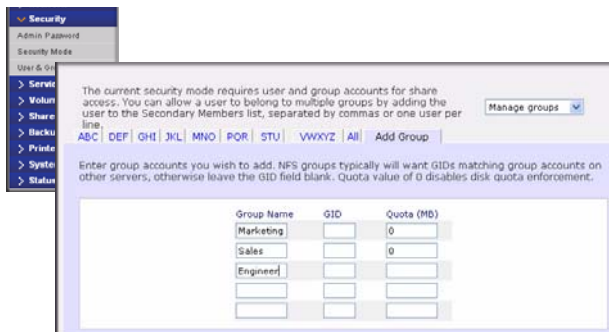

Figure 3-2

After adding your groups, you can view or change your groups by clicking the alphabetical index tab, or click **All** to list all groups.

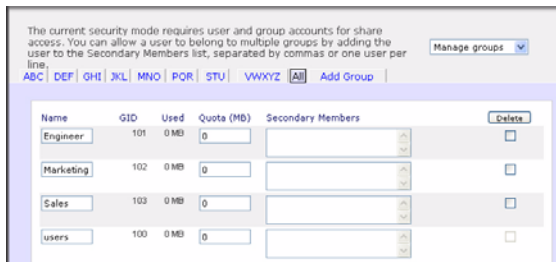

Figure 3-3

If you wish to add a large number of groups, select **Import group list** from the pull-down menu.

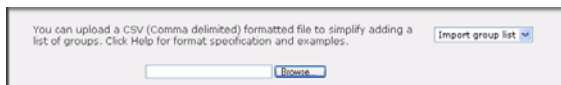

Figure 3-4

You can upload a CSV (Comma Separated Value) formatted file containing the group account information. The format of the file is:

```
name1,gid1,quota1,member11:member12:member13
name2,gid2,quota2,member21:member22:member23
name3,gid3,quota3,member31:member32:member33
```

:

Please note the following:

- Spaces around commas are ignored.

- The name field is required.
- Quota is set to default if not specified.
- GID is automatically generated if not specified.
- Empty fields are replaced with account defaults.
- Group members are optional.

Examples of acceptable formats are as follows (note that you can omit follow-on commas and fields if you wish to accept the system defaults for those fields, or you can leave the fields empty):

```
flintstones
```

In this example, the group `flintstones` is created with an automatically assigned GID and default quota.

```
rubble,1007,5000,barney:betty
```

In this example, the group `rubble` has a GID of 1007, a quota of 5000 MB, with members `barney` and `betty`.

Managing Users

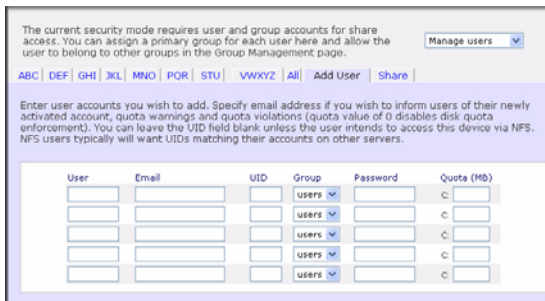

Figure 3-5

To manage user accounts:

1. Select **Manage Users** from the drop-down menu.
2. Click the **Add User** tab to add a new user. You can add up to five users at a time. For each user, add the following information:
 - User name,
 - E-mail address
 - User ID
 - Select a group from the **Group** pull-down menu.

- Password
- Disk quota.

3. Click **Apply** to save your settings.

Only the user name and password fields are required; however, you should specify a user e-mail address if you intend to set up disk quotas. Without an e-mail address, the user will not be warned when disk usage approaches the specified disk quota limit. If you do not wish to assign a disk quota, enter 0.

If you wish to add a large number of users, select **Import user list** from the pull-down menu.

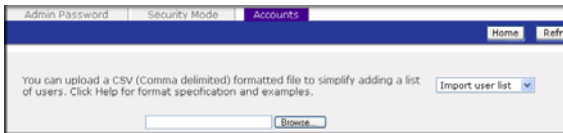

Figure 3-6

Here, you can upload a CSV (Comma Separated Value) formatted file containing the user account information. The format of the file is:

```
name1,password1,group1,email1,uid1,quota1
name2,password2,group2,email2,uid2,quota2
name3,password3,group3,email3,uid3,quota3
:
```

Please note the following:

- Spaces around commas are ignored.
- The name and password fields are required.
- If a listed group account does not exist, it is automatically created.
- Group and quota are set to the defaults if not specified.
- E-mail notification is not sent to the user if the field is omitted or left blank.
- UID is automatically generated if not specified.
- Empty fields are replaced with account defaults.

Examples of acceptable formats are as follows (note that you can omit follow-on commas and fields if you wish to accept the system defaults for those fields, or you can leave the fields empty):

```
fred,hello123
```

In this example, user **fred** has a password set to **hello123**, belongs to the default group, receives no e-mail notification, has a UID assigned automatically, and has a default quota.

barney,23stone,,barney@bedrock.com

In this example, user **barney** has a password set to **23stone**, belongs to the default group, receives e-mail notification sent to barney@bedrock.com, has a UID assigned automatically, and has a default quota.

wilma,imhiswif,ourgroup,wilma@bedrock.com,225,50

In this example, user **wilma** has a password **imhiswif**, belongs to the group **ourgroup**, receives e-mail notification sent to wilma@bedrock.com, has a UID set to 225, and a quota set to 50 MB.

Setting Accounts Preferences

You can set various account defaults by selecting **Preferences** option from the pull-down menu.



Figure 3-7

Changing User Passwords

There are two ways in which user passwords can be changed. The first way is for the administrator to change the passwords by selecting Security > User & Group Accounts and then selecting **Manage Users** from the pull-down menu. The other and preferred way is to allow users to change their own passwords. This relieves the administrator from this task and encourages users to change their passwords on a more regular basis for enhanced security.

Users can use the Web browser and their existing password to log in to https://<ip_addr>/ to access the Web share listing page. Then select the Password tab, and follow the prompts to set a new password.

Managing Your Shares

Shares enable you to organize the information stored on a volume, and administer who has access to that information. For example, generic policies and forms like blank expense reports everyone

should be able to access, compared with sensitive data like financial information only the finance group should be able to access.

The Shares menu provides all the options pertaining to share services for the ReadyNAS Pro Pioneer Edition device. This entails share management (including data and print shares), volume management, and share service management.



Figure 3-8

Adding Shares

To add a share:

1. From the main menu, select Volumes > Volume Settings. If more than one volume is configured, click on the volume you wish to add the share.
2. Select Add Shares. Enter the share name and description.

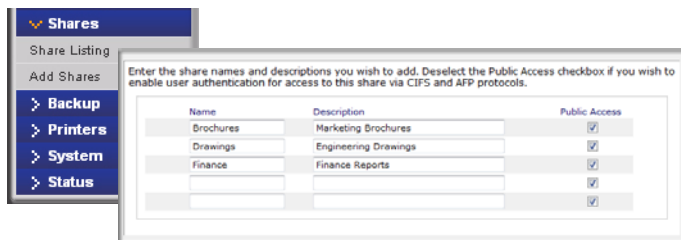

Figure 3-9



Note: Enabling Public Access means the Guest account has access to the share.

Once you finish adding the shares, refer to [Chapter 5, “Accessing Shares from Your Operating System”](#) for instructions on how to access them from different client interfaces.

Managing Shares

Once you have added shares, you can manually fine-tune share access by selecting Share List.

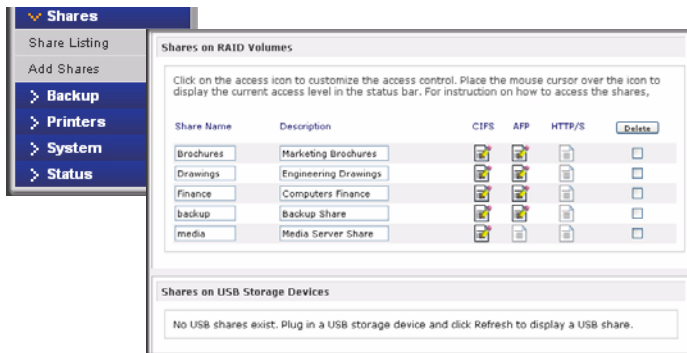

Figure 3-10

If you want to delete a share, select the check box on the far right of the share listing and click **Delete**.

The columns to the left of the Delete check box represent the services that are currently available. The access icons in those columns summarize the status of the service and the access rights to the share for each of the services. Move the mouse pointer over the access icons to view the access settings.



Figure 3-11

The settings are as follows:

- **Disabled.** Access to this share is disabled.
- **Read-only Access.** Access to this share is read-only.
- **Read/Write Access.** Access to this share is read/write.
- **Read Access with exceptions.** Either (1) access to this share is read-only and allowed only for specified hosts, (2) access is read-only except for one or more users or groups that are granted

read/write permission, or (3) access is disabled except for one or more users or groups that are granted read-only privilege.

- **Write Access with exceptions** – Either (1) access to this share is read/write and allowed only for specified hosts, (2) access is read/write except for one or more users or groups that are restricted to read-only access, or (3) access is disabled except for one or more users or groups that are granted read/write privilege.

You can click on the access icons to display the Share Options screen, where you can set the access rules for each file protocol. Keep in mind that access options differ between protocols.

Setting Share Access

Access the CIFS Share Access Restrictions screen by clicking on the file system icon.

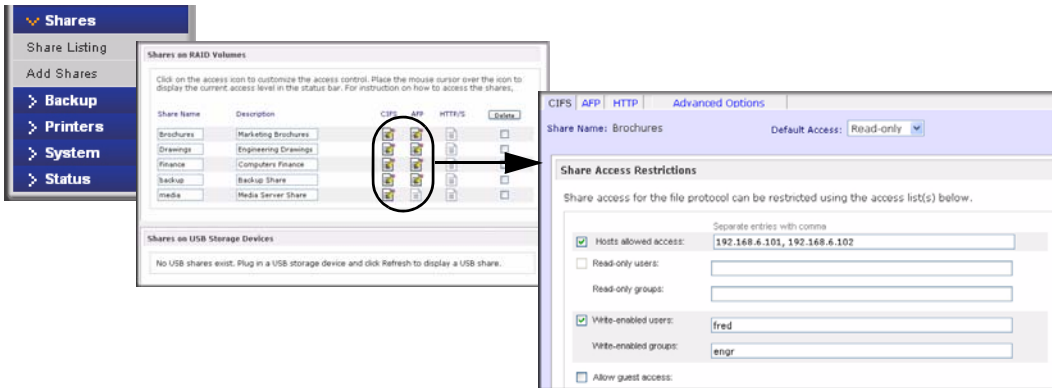

Figure 3-12

Share Access Restriction. If you wish to limit share access to particular users and/or groups, you can enter their names in the **Read-only users**, **Read-only groups**, **Write-enabled users**, and **Write-enabled group** fields. The names must be valid accounts on the ReadyNAS Pro. Note that access control differs slightly from service to service.

For instance, if you wish to allow read-only access to all and read/write access only user **fred** and group **enrg**, you would set the following:

- Default: **Read-only**
- Write-enabled users: **fred**
- Write-enabled groups: **enrg**

If you wish to limit this access only to hosts 192.168.2.101 and 192.168.2.102, set the following:

- Default: **Read-only**

- Hosts allowed access: **192.168.2.101, 192.168.2.102**
- Write-enabled users: **fred**
- Write-enabled groups: **engr**

If you wish to specify some users and groups for read-only access and some for read/write access, and disallow all other users and groups, enter the following:

- Default: **Disabled**
- Hosts allowed access: **192.168.2.101, 192.168.2.102**
- Read-only users: **mary, joe**
- Read-only groups: **marketing, finance**
- Write-enabled users: **fred**
- Write-enabled groups: **engr**

If you wish to guests access to this share, check the Allow guest access checkbox.

Share Display Option. Restricting access to a share does not prevent users from seeing the share in the browse list. In certain instances, you might not want this, such as for backup shares that you might want to prevent users from seeing.

To hide a share, select the **Hide this share...** check box. Users who have access to this share must specify the path explicitly. For example, to access a hidden share, enter **\\host\share** in the Windows Explorer address bar.

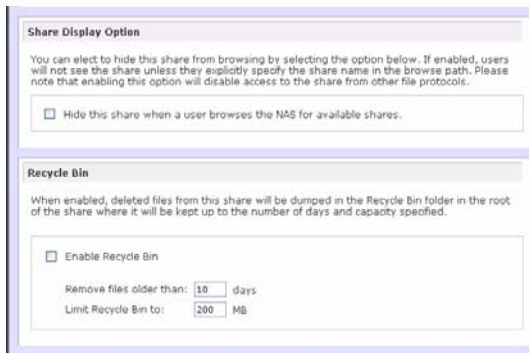

Figure 3-13

Recycle Bin. The ReadyNAS Pro Pioneer Edition can have a Recycle Bin for each share for Windows users. The **Enable Recycle Bin** option is shown at the bottom of the CIFS screen.

When this check box is selected, whenever you delete a file, the file gets inserted into the Recycle Bin folder in the share rather than being permanently deleted. This allows for a grace period during which users can restore deleted files.

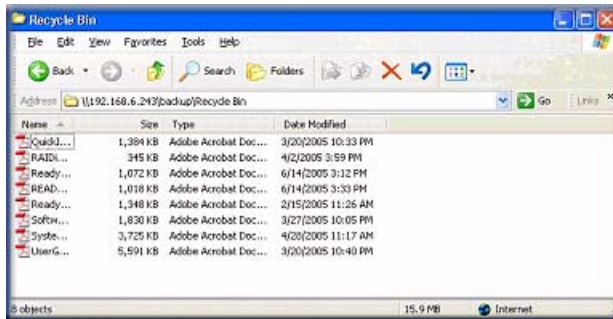

Figure 3-14

You can specify how long to keep the files in the Recycle Bin and how large the Recycle Bin can get before files get permanently erased.

Advanced CIFS Permission. The Advanced CIFS Permission section offers options for setting the default permission of new files and folders created through CIFS. The default permission of newly created files is read/write for the owner and owner's group and read-only for others (that is, everyone). Permission for newly created folders is read/write for everyone. If the default does not satisfy your security requirement, you can change it here.

Opportunistic locking (often referred to as oplocks) enhances CIFS performance by allowing files residing on the NAS to be cached locally on the Windows client, thus eliminating network latency when the files are constantly accessed.



Figure 3-15

Advanced Options

The Advanced Options tab offers advanced low-level file manipulation options that can affect remote file access through all file protocol interfaces. Care should be taken before you use these options as anything that changes ownership and permissions might not be easily reversible.

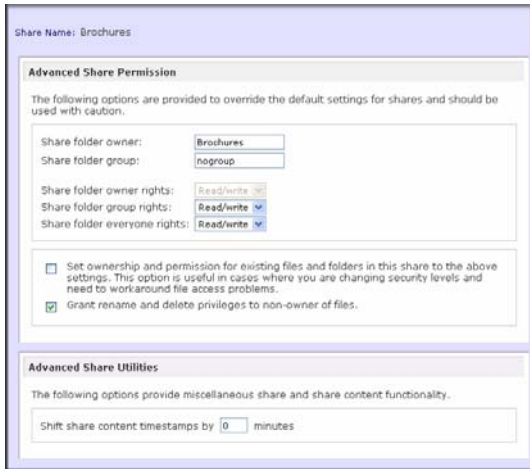

Figure 3-16

Advanced Share Permission. The Advanced Share Permission section offers the options to override the default ownership and permission of the share folder on the embedded file system and to permeate these settings to all files and folders residing on the selected share. The **Set ownership and permission for existing files and folders** option performs a one-time change. Depending on the size of the share, this can take a while to finish.

You can also grant rename and delete privilege to non-owners of the files option. In a collaborative environment, you might want to enable this option. In a more security-conscious environment, disable this option.

Web Browser

To access the same share using a Web browser, enter **http://<ipaddr>** in the browser address bar. You can use **https** if you want a secure encrypted connection. You will be prompted to log in.



Figure 3-17

Log in with a valid user name and password.

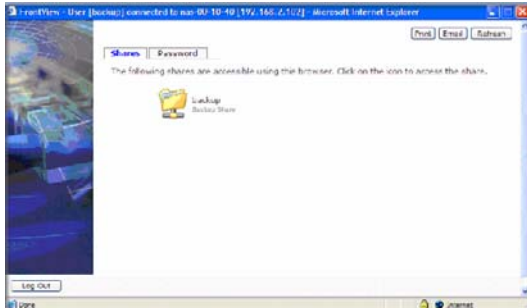

Figure 3-18

If the Share access is read-only, only the file manager displays.

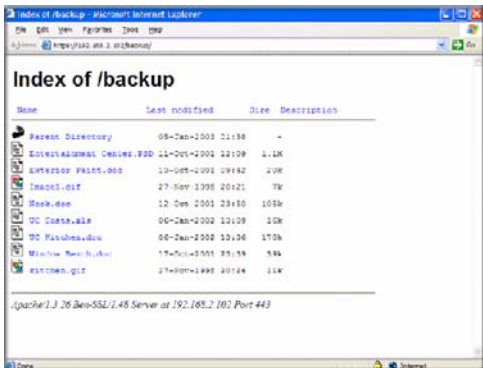

Figure 3-19



Note: Files created under the Web file manager can be deleted only under this file manager. The only exception is for the admin user; the admin user can change or delete any files created through the web. Files not created from this file manager can be modified within the file manager but cannot be deleted here.

If the Share is also writable, the file manager displays options for creating, modifying, and deleting files, as follows.

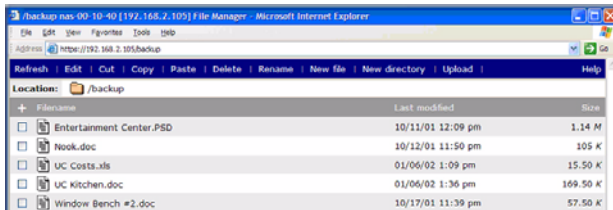

Figure 3-20

One useful application for a Web share is to set up an internal company website. You can copy HTML files to the Web share using Windows, Mac, NFS, or HTTP. When you set HTTP access to read-only, html files, including *index.htm* and *index.html*, can be viewed using any web browser.

FTP/FTPS

To access the share, use the appropriate user login and password used to access the ReadyNAS. For better security, use an FTPS (FTP-SSL) client to connect to the ReadyNAS FTP service. With FTPS, both the password and data are encrypted.

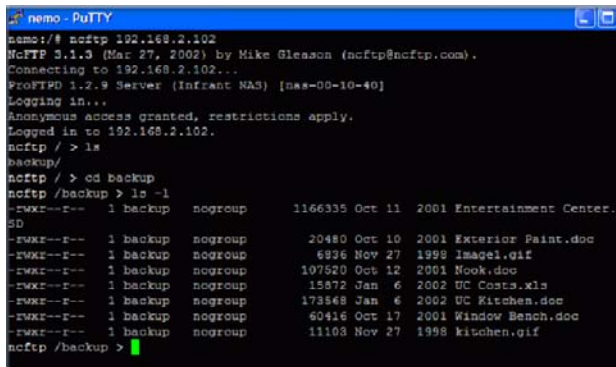

Figure 3-21

Rsync

If you specified a user or password in the rsync share access tab, you will need to specify this when accessing the rsync share. Unlike other protocols, rsync uses arbitrary user name and password that is specific only for rsync access. The user account you specify does not need to exist on the ReadyNAS.

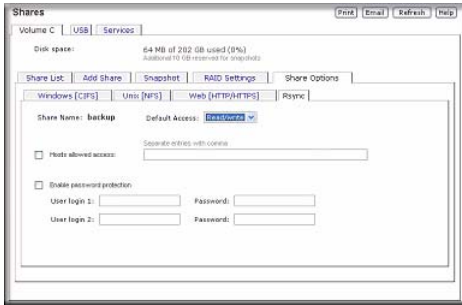

Figure 3-22

Here is an example of a way for a Linux client to list the content of a ReadyNAS rsync share with no user name and password defined:

```
# rsync <ipaddr>::backup
```

To recursively copy the content of a share to /tmp:

```
# rsync -a <ipaddr>::backup /tmp
```

To do the same except with a login **user** and password **hello**, enter:

```
# rsync -a user@<ipaddr>::backup /tmp
```

```
Password: *****
```



Note: The ReadyNAS does not support Rsync over SSH.

Networked DVD Players and UPnP AV Media Adapters

Networked DVD players and UPnP AV Media adapters detect the ReadyNAS if either the Home Media Streaming Server or the UPnP AV services are enabled. The content of the Streaming Services media share on the ReadyNAS is available to these players for playback.¹ Multiple players can be connected to the ReadyNAS and can play the media files concurrently.

Make sure that you enable the appropriate service in the Services tab before invoking the service.

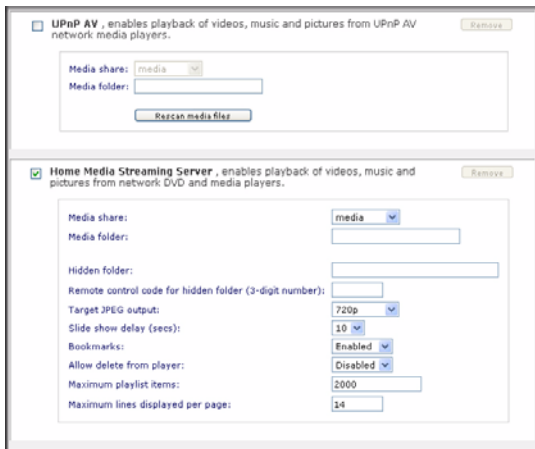

Figure 3-23

Consult the Device Compatibility list for information about which DVD players and media adapters work with the ReadyNAS.

Remote Access

You can remotely access your ReadyNAS Pro from the Internet via FTP and HTTP. Follow these instructions to enable remote access to your ReadyNAS Pro.

1. Consult the player manual for information on the file formats that it supports.

Remote FTP Access

1. Go to **Services > Standard File Protocols** and enable FTP.

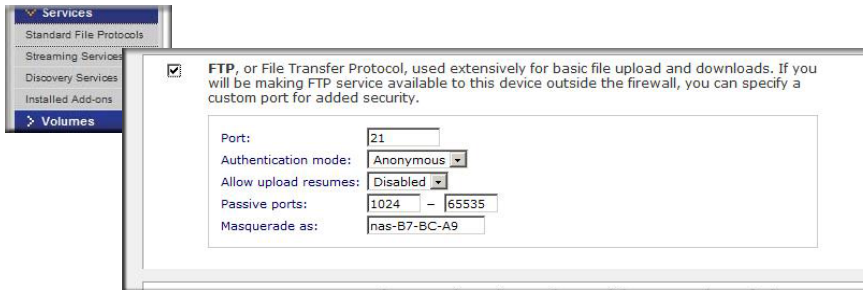

Figure 3-24

- **Port:** The TCP/IP port that the FTP service will be using. The default is 21, this port will need to be forwarded through the router. Refer to the port forwarding instructions provided with your router.
- **Authentication mode:**
Anonymous: No login information required for FTP users.
User: Users will need an account configured on the ReadyNAS.
- **Allow upload resumes:** This allows users to finish uploading a file to the FTP share if the connection had been previously interrupted. Without this option enabled, if the connection is dropped at 50% completion, the file upload must restart from the beginning.
- **Passive ports:** This port range is required to enable remote access to the ReadyNAS from over the Internet. This port range should be adjusted to the maximum number of concurrent sessions the user expects to run at one time. If you expect frequent concurrent access from many users, double this number, as each FTP user will consume a passive port.
- **Masquerade as:** This field is for adjusting the hostname that the FTP server reports to an FTP client.

2. Configure the FTP share access options.

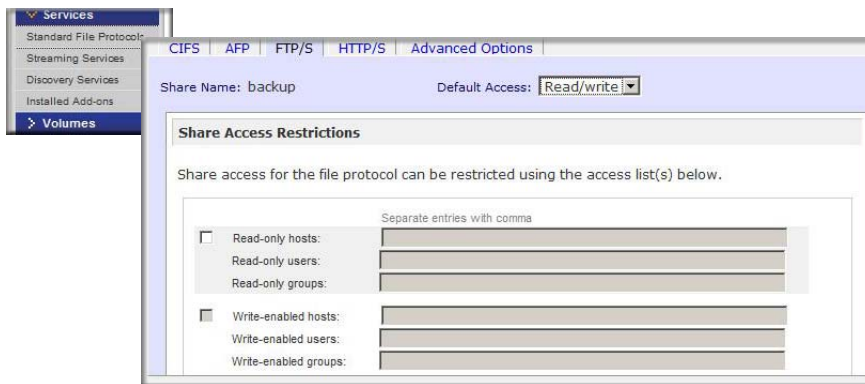

Figure 3-25

Change the Share Access Restrictions to allow FTP access to the share according to the user permissions you require.

Remote HTTP Access

1. Go to **Services > Standard File Protocols** and enable FTP.

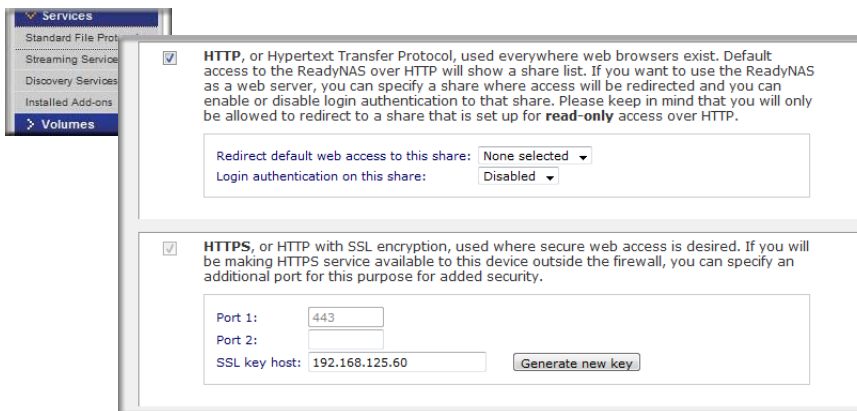

Figure 3-26

	<p>Note: HTTPS cannot be disabled - Frontview requires it.</p>
---	---

- **HTTP**

- Redirect default web access to this share: Advanced configuration option allowing hosting of user created HTTP web page on the ReadyNAS.
- Login authentication on this share: Configures the above mentioned share for whether or not authentication is required if users are browsing to the user created web content

- **HTTPS**

- **Port 1:** This field cannot be modified; it is reserved for the ReadyNAS.
- **Port 2:** This field can be used to allow https connections over a port other than the standard 443. Doing so will require enabling port forwarding of this port on the router.
- **SSL key host:** This field lets you configure the hostname used for the ReadyNAS to generate its SSL certificate, and then create a new SSL certificate. It is advised users update this field to match the current IP address of the ReadyNAS and then generate a new SSL certificate to avoid future certificate errors from their web browser.



Note: In this scenario, it is best to have a fixed IP configuration for the ReadyNAS so that the certificate will remain valid. Also, if the WAN IP address configuration is DHCP, then it is advisable to use a Dynamic DNS service to access the ReadyNAS via a persistent fully qualified domain name a DDNS service provides rather than via an IP address.

2. Configure the HTTP/S share access options.



Figure 3-27

Change the Share Access Restrictions to allow HTTP access to the share according to the user permissions you require.

- 3. Enable WebDAV support:** WebDAV is an HTTP connection method that can allow drag and drop file transfers similar to what users may experience with their standard Windows or Mac OSX computer. See ReadyNAS.com for a how-to explanation of how to set up WebDAV:
<http://www.readynas.com/?p=126>

Chapter 4

Securing Your Data

This chapter explains how to back up the data from your ReadyNAS.

- “Configuring Backup Jobs
- “Backing Up the ReadyNAS to a USB Drive

Configuring Backup Jobs

The Backup Manager integrated with the ReadyNAS Pro Pioneer Edition allows the ReadyNAS Pro Pioneer Edition to act as a powerful backup appliance. Backup tasks can be controlled directly from the ReadyNAS Pro Pioneer Edition without the need for a client-based backup application.

With the flexibility to support incremental backups over CIFS/SMB, NFS, and rsync protocols, and full backups over FTP and HTTP protocols, the ReadyNAS Pro Pioneer Edition can act as a simple central repository for both home and office environments. And with multiple ReadyNAS Pro Pioneer Edition systems, you can set up one ReadyNAS Pro Pioneer Edition to back up another directly.

Adding a New Backup Job

To create a new backup job, select **Add a New Backup Job** and follow the 4-step procedure.

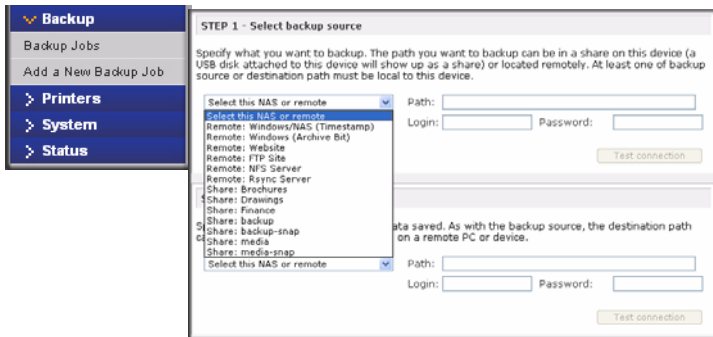

Figure 4-1

Step 1 – Select Backup Source

The backup source can be located remotely, or it can be a public or a private home share, or all home shares on the ReadyNAS Pro Pioneer Edition.

A USB device appears as a share, so if you want to back up a USB device, select a share name. If you want to back up data from a remote source, select from one of the following:

- **Windows/NAS (Timestamp).** Select this if you wish to back up a share from a Windows PC. Incremental backups use timestamps to determine whether files should be backed up.
- **Windows/NAS (Archive Bit).** Select this if you wish to back up a share from a Windows PC. Incremental backups use the archive bit of files, similar to Windows, to determine whether they should be backed up.
- **Website.** Select this if you wish to back up a website or a website directory. The backed up files include files in the default index file and all associated files, as well as all index file links to web page image files.
- **FTP site.** Select this if you wish to back up an FTP site or a path from that site.
- **NFS server.** Select this option if you wish to back up from a Linux or UNIX server across NFS. Mac OS X users can also use this option by setting up a NFS share from the console terminal.
- **Rsync server.** Select this if you wish to perform backups from a rsync server. Rsync was originally available for Linux and other flavors of UNIX, but has lately become popular under Windows and Mac for its efficient use of incremental file transfers. This is the preferred backup method between two ReadyNAS devices.

Once you have selected a backup source, you can enter the path from that source. If you selected a ReadyNAS Pro Pioneer Edition share, you can either leave the path blank to backup the entire share, or enter a folder path. Note that you should use forward slashes (/), in place of back slashes (\).

If you selected a remote source, each remote protocol uses a slightly different notation for the path. If the path field is empty, selecting the remote source in the pull-down menu shows an example format of the path.

Following are some examples:

- Examples of an FTP path:
ftp://myserver/mypath/mydir
ftp://myserver/mypath/mydir/myfile
- Examples of a website path:
http://www.mywebsite.com
http://192.168.0.101/mypath/mydir
- Examples of a Windows or remote NAS path:
//myserver/myshare
//myserver/myshare/myfolder
//192.168.0.101/myshare/myfolder
- Examples of an NFS path:
myserver:/mypath
192.168.0.101:/mypath/myfolder
- Examples of a Rsync path:
myserver::mymodule/mypath
192.168.0.101::mymodule/mypath
- Examples of a local path:
myfolder
media/Videos
My Folder
My Documents/My Pictures

To make sure that you have proper access to the backup source, click **Test Connection** before continuing.

Step 2 – Select Backup Destination

The Step 2 process is almost identical to Step 1 except that you are now specifying the backup destination. If you selected a remote backup source, you need to select a public or a private home share on the ReadyNAS Pro Pioneer Edition (either the source or destination must be local to the

ReadyNAS Pro Pioneer Edition). If you selected a ReadyNAS Pro Pioneer Edition share for the source, you can either enter another local ReadyNAS Pro Pioneer Edition share for the destination, or you can specify a remote backup destination.

STEP 1 - Select backup source

Specify what you want to backup. The path you want to backup can be in a share on this device (a USB disk attached to this device will show up as a share) or located remotely. At least one of backup source or destination path must be local to this device.

Share: backup Path:

Login: Password:

Test connection

STEP 2 - Select backup destination

Specify where you want your backup data saved. As with the backup source, the destination path can be a share on this device or a path on a remote PC or device.

Remote: Windows/NAS (Timestamp) Path: Example: //host/share/path

Login: admin Password:

Test connection

Figure 4-2

The remote backup destination can be a Windows PC/ReadyNAS Pro Pioneer Edition system, an NFS server, or a rsync server. Note that you can select **rsync** for a remote ReadyNAS Pro Pioneer Edition if it is configured to serve data over rsync.

Step 3 – Choose Backup Schedule

You can select a backup schedule as frequently as once every 4 hours daily or just once a week.

	Note: Backup jobs cannot go past midnight to the next day. Set a backup job start stop time that does not traverse midnight.
--	---

If you wish, you can elect not to schedule the backup job so that you can invoke it manually instead by clearing (deselecting) the **Perform backup every...** check box. (You might want to do this if your ReadyNAS has a backup button.)

The screenshot shows a web-based configuration interface for backup scheduling. It is divided into two sections: 'STEP 3 - Choose backup schedule' and 'STEP 4 - Choose backup options'.

STEP 3 - Choose backup schedule
 Select when you want the backup performed.
 Perform backup every 24 hours between 08:05 and 23:05
 Sun Mon Tue Wed Thu Fri Sat [Select All Days](#)

STEP 4 - Choose backup options
 Select the desired options when backup is performed. A full backup will copy all data from the backup source. Incremental backup, where only changed data are copied, occurs between scheduled full backups, unless **Every time** is selected.
 Schedule full backup: First time
 On backup completion, send errors only to the alert email address.
 Remove the contents of the backup destination before a full backup is performed. This will clean the backup destination of files which were removed in the backup source. **Warning:** This will delete all files and folders in the backup destination.
 Remove deleted files on backup target (sync only).
 After backup is complete, change ownership of files in the backup destination to the share owner if the destination is a NAS share. This will allow access to backed up files in Share security mode. **Warning:** Do not use this option if any files or directories should retain their current ownership.

Figure 4-3

Step 4 – Choose Backup Options

In this last step, you can set up how you want backups to be performed. To set up a backup schedule:

1. **Schedule a full backup.** Select when you want full backups to be performed. You can elect to do this just the first time, every week, every 2 weeks, every 3 weeks, every 4 weeks, or every time this backup job is invoked.

The first full backup is performed at the next scheduled occurrence of the backup depending on the schedule you specify, and the next full backup is performed at the weekly interval you choose calculated from this first backup. Incremental backup is performed between the full backup cycles.

Backups of a Web or FTP site only have the option to do a full backup every time.

2. **Send a backup log.** Backup logs can be sent to the users on the Alert contact list when the backup is complete. It is a good idea to select this option to make sure that files are backed up as expected. You can elect to send only errors encountered during backup, full backup logs consisting of file listings (can be large), or status and errors (status refers to completion status).



Note: Backup log e-mails are restricted to approximately 10K lines. To view the full backup log (regardless of length), select Status > Logs and click the **Download All Logs** link.

3. **Remove files from backup destination.** Select if you want to erase the destination path contents before the backup is performed. Be careful not to reverse your backup source and

destination as doing so can delete your source files for good. It is safer to not select this option unless your device is running low on space. Do experiment with a test share to make sure you understand this option.

- 4. Remove deleted files on backup target for rsync.** By default, files deleted in the backup source will not get deleted in the backup destination. With rsync, you have the option of simulating mirror mode by removing files in the backup destination deleted from the backup source since the last backup. Select this option if you wish to do this. Experiment with a test share to make sure that you understand this option.
- 5. Change ownership of backup files.** The Backup Manager attempts to maintain original file ownership whenever possible. To work around this, you have the option of automatically changing the ownership of the backed-up files to match the ownership of the share. This allows anyone who can access the backup share to have full access to the backed-up files.
- 6. Click **Apply**** to save your settings.

Before trusting your backup job to a schedule, it is a good practice to manually perform the backup to make sure that access to the remote backup source or destination is granted, and that the backup job can be done within the backup frequency you selected. This can be done after you save the backup job.

Viewing the Backup Schedule

After saving the backup job, a new job appears in the Backup Schedule section of the Backup Jobs screen.

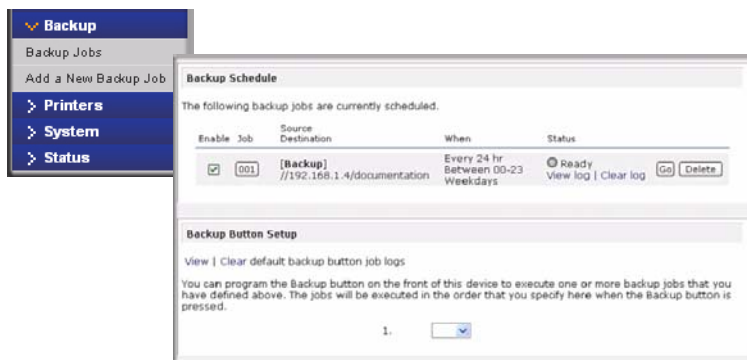

Figure 4-4

A summary of the backup jobs that have been scheduled are shown; jobs are numbered beginning at 001.

To manage your backup jobs:

1. Click the Job number icon to modify the selected backup job.
2. Enable or disable job scheduling by selecting/clearing the **Enable** check box. Disabling the job does not delete the job, but removes it from the automatic scheduling queue.
3. Click **Delete** to permanently remove the job.
4. Click **Go** to manually start the backup job. The status changes when the backup starts, when an error is encountered, or when the job has finished.
5. Select the **View Log** link to check a detailed status of the backup.
6. Click **Clear Logs** to clear the current log detail.

Programming the Backup Button

You can program the backup button (see the illustration at [page 1-4](#)) to execute one or more pre-defined backup jobs (see “[Backing Up the ReadyNAS to a USB Drive](#)” on [page 4-8](#) for more information).



Figure 4-5

Simply select the backup jobs in the order that you want them run and click **Apply**. Pressing the Backup Button once starts the job(s).

Viewing the Backup Log

You can view the backup log while the job is in progress or after it has finished.

```

Backup finished Mon Aug 7 19:09:20 PDT 2006
INCREMENTAL Backup started Mon Aug 7 19:08:08 PDT 2006

Job: 001
Protocol: cifs
Source: //192.168.6.157/Competition/data5
Destination: [Backup/]

/job_001//data5/Book1_april7_inv.xls -> /Backup/Book1_april7_inv.xls
/job_001//data5/Book1_april7_ord.xls -> /Backup/Book1_april7_ord.xls
/job_001//data5/Book1_april7_bck.xls -> /Backup/Book1_april7_bck.xls
/job_001//data5/Book1_april14_inv.xls -> /Backup/Book1_april14_inv.xls
/job_001//data5/Book1_april14_ord.xls -> /Backup/Book1_april14_ord.xls
/job_001//data5/Book1_april14_bck.xls -> /Backup/Book1_april14_bck.xls
/job_001//data5/Book1_april21_inv.xls -> /Backup/Book1_april21_inv.xls
/job_001//data5/Book1_april21_bck.xls -> /Backup/Book1_april21_bck.xls
/job_001//data5/Book1_april21_ord.xls -> /Backup/Book1_april21_ord.xls
/job_001//data5/Book3_MAR_ord.xls -> /Backup/Book3_MAR_ord.xls
/job_001//data5/Book1_april26_bck.xls -> /Backup/Book1_april26_bck.xls
/job_001//data5/Book2_APR_inv.xls -> /Backup/Book2_APR_inv.xls
/job_001//data5/Book1_april29_inv.xls -> /Backup/Book1_april29_inv.xls
/job_001//data5/Book1_april29_ord.xls -> /Backup/Book1_april29_ord.xls
/job_001//data5/Book2_FEB_inv.xls -> /Backup/Book2_FEB_inv.xls
/job_001//data5/Book3_APR_ord.xls -> /Backup/Book3_APR_ord.xls
/job_001//data5/Book2_MAR_inv.xls -> /Backup/Book2_MAR_inv.xls
/job_001//data5/Book2_MAR_inv.xls -> /Backup/Book2_MAR_inv.xls
/job_001//data5/Book3_FEB_ord.xls -> /Backup/Book3_FEB_ord.xls

```

Figure 4-6

The log format might differ depending on the backup source and destination type that was selected, but you can see when the job was started and finished, and whether it was completed successfully or with errors.

Editing a Backup Job

To edit a backup job, you can either click the 3-digit job number button in the Backup Jobs screen, or you can click the **Edit Backup Job** link while viewing that job log. You can then make appropriate changes or adjustments to the job.

Backing Up the ReadyNAS to a USB Drive

The following sections describe how to back up and remove disks from the ReadyNAS systems.

On the ReadyNAS Pro Pioneer Edition, the Backup button is associated with the USB Port at the front of the system. By default, the Backup button copies the data from the Backup share onto the USB disk connected to the USB port at the front of the device.

You can program backups for one or more predefined backup jobs.



Warning: Make sure that you have a USB hard drive attached to the front USB Port *before* pressing the Backup button.

Chapter 5

Optimizing Performance

This chapter discusses how to optimize ReadyNAS performance

- “Performance
- “Power Management

Performance

If you wish to tweak the system performance, select Performance from the main menu. Note that some of the settings suggest that you utilize an Uninterruptible Power Supply (UPS) before enabling that option:

- NETGEAR recommends that you select the **Disable journaling** only if the NAS has UPS protection. Without battery backup, there is a small chance that parity written to a disk in a RAID set might become out of sync with the data disks if a power failure suddenly occurs, possibly causing incorrect data to be recovered if one disk fails. Without full data journaling, disk write performance increases substantially.

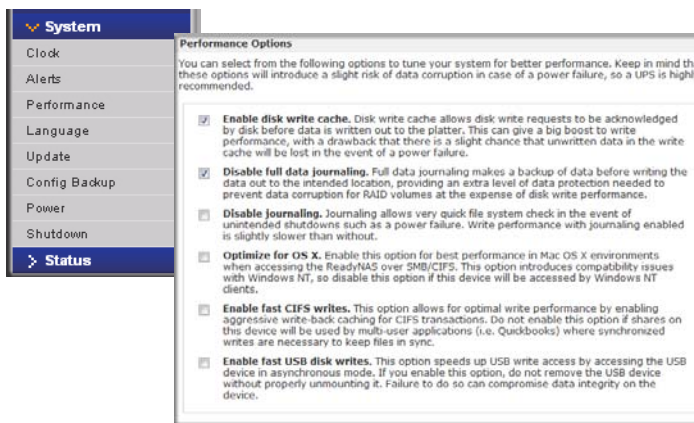

Figure 5-1

- Select **Enable disk write cache** if you want to allow disk write requests to be acknowledged by the disk before data is written out to the platter. This can give a big boost to write

performance, with a drawback that there is a slight chance that unwritten data in the write cache will be lost in the event of a power failure.

- Select **Disable journaling** if you understand the consequences of this action, and you do not mind a long file system check (only after unexpected power failures). File system journaling allows disk checks of only a few seconds verses possibly an hour or longer without journaling. Disabling journaling improves disk write performance slightly.
- The **Optimize for OS X** option provides the best performance in Mac OS X environments when connected to the ReadyNAS Pro Pioneer Edition through the SMB/CIFS protocol. This option, however, introduces compatibility issues with Windows NT 4.0; do not enable this option if this device will be accessed by Windows NT 4.0 clients.
- The **Enable fast CIFS writes** option allows for fast write performance by enabling aggressive write-back caching over CIFS. Do not enable this option in multi-user application environments such as Quick Books where synchronized writes are necessary to keep files in sync.
- The **Enable fast USB disk writes** option speeds up USB write access by allowing access to the USB device in asynchronous mode. If you enable this option, do not remove the USB device without properly unmounting it. Failure to do so can compromise data integrity on the device.

Adding a UPS to Protect Against Power Failures

Adding a UPS to the NAS is an easy way to protect against power failures. Simply connect the ReadyNAS power cable to the UPS, and connect the UPS USB monitoring cable between the UPS and the ReadyNAS. The UPS is detected automatically and shows up in the Status bar. Move the mouse pointer over the status light to display device information, or click a status light to display the status in more detail.



Figure 5-2

You get e-mail alerts about changes in the UPS status; for example, upon a power failure or if the battery is low. When the battery is low, the NAS device automatically shuts down safely.



Tip: Remember that when monitoring an attached UPS with the ReadyNAS you can disable Journaling in the Optimization settings to increase performance.

Power Management

The ReadyNAS Pro Pioneer Edition offers disk spin-down, power timer (time off/time on), UPS event, and wake-on-LAN power management options to reduce system power consumption, both while the system is in use and when it is not in use.

Disk Spin-Down Option

You can elect to spin down your ReadyNAS disks after a specified time of inactivity. The disks will spin up as needed. To enable spin-down mode, select the **Enable disk spin-down after...** check box, and specify the minutes of inactivity before spin up.

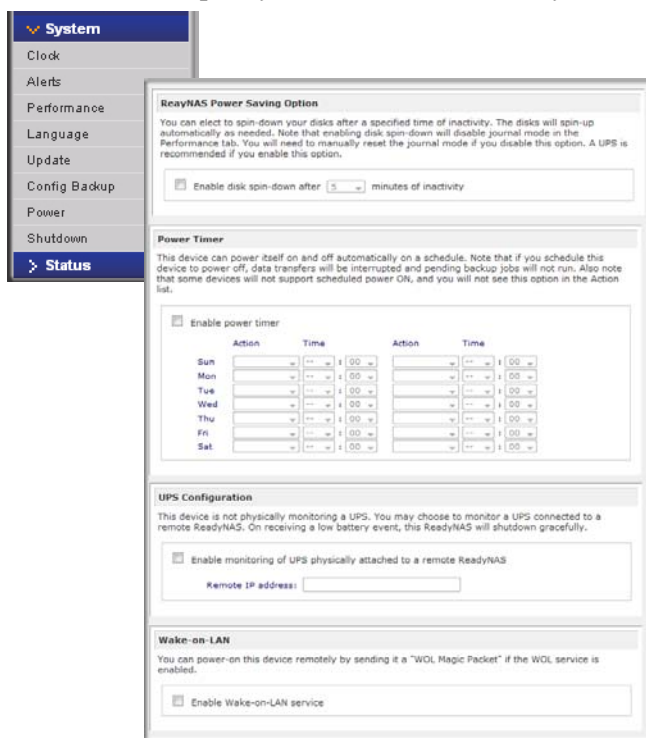

Figure 5-3



Note: Enabling disk spin-down disables journal mode. Once enabled, if you decide to disable disk spin-down, you need to manually re-enable journal mode if desired. NETGEAR recommends UPS if you utilize this option.

Power Timer

The ReadyNAS Pro Pioneer Edition can be scheduled to power off and power back on (on certain models) automatically (see [Figure 5-3](#)). Select the **Enable power timer** check box and enter the action and time. (The **Power ON** option is available on the ReadyNAS Pro Pioneer Edition NV through an add-on package.)¹ The **Power ON** option does not appear if the ReadyNAS Pro Pioneer Edition hardware does not support this feature.



Note: When the ReadyNAS Pro Pioneer Edition is powered off, any file transfers and backup jobs are interrupted, and backup jobs scheduled during the power off state do not run.

UPS Configuration

If this device is not connected to a UPS device, you may elect to enable a UPS connection to another NAS device. Select the **Enable monitoring of UPS physically attached to a remote ReadyNAS** check box and enter the IP Address in the **Remote IP** field. NETGEAR recommends that you enable this feature if you have enabled the Disk Spin-Down option.

If you use this option, the ReadyNAS is shut down automatically when a battery-low condition is detected on a UPS connected to another ReadyNAS. This is useful when a UPS is shared by multiple ReadyNAS units, even though only one ReadyNAS is monitoring the battery status.

As an option, the ReadyNAS can remotely monitor the UPS when connected to a PC running Network UPS Tools (NUT). For more information about NUT, see <http://www.networkupstools.org>.

Wake-On-LAN

You can power-on this device remotely by sending it a “WOL Magic Packet” if the WOL service is enabled.

1. Please refer to the Release Notes for RAIDiator 4 on the NETGEAR Support site for more information.

Chapter 6

Managing Levels of Service

This chapter presents system status, alerts, replacing failed disks, and scheduling topics.

- [“Viewing System Status](#)
- [“Replacing a Failed Disk](#)
- [“Using the System Diagnostic Menu](#)

Viewing System Status

The Status menu contains links to the Health screen and Logs screen that provide system status information.

Health

The Health screen displays the status of each disk, and the fan, temperature, and UPS status in detail. When available, normal expected values are provided.



Figure 6-1

For each disk, you can click **SMART+** (Self-Monitoring, Analysis and Reporting Technology) to display the content of the internal disk log.



Figure 6-2

To recalibrate the fan, click **Recalibrate**.

Logs

Select Status > Logs to access the Clear Logs screen. The Clear Logs screen provides information about the status of management tasks, including a timestamp.



Figure 6-3

The **Download All Logs** link is available in case you need to analyze low-level log information. If you click this link, a zip of all the logs is provided.

Replacing a Failed Disk



Note: Be sure to check the Hardware Compatibility list on the NETGEAR support site for a list of disks that have been qualified for the ReadyNAS Pro to assure that you use a suitable disk.

When a disk fails in your ReadyNAS device, you are notified of the failure by e-mail. The failed disk location can be seen in the FrontView status bar at the bottom by selecting Status > Health.



Figure 6-4

On the front of the ReadyNAS device, a failed disk is identified by an amber LED. The left most LED is disk channel 1; the next one is disk channel 2; and so on. Take note of the failed channel.

Choosing a Replacement Disk

On the main menu, select Status > Health. Take note of the disk vendor and model used in your ReadyNAS. It is best to replace a failed disk with the same disk model. Contact the disk vendor, and arrange to have the disk replaced if the disk is still under warranty. A disk RMA from the vendor requires that you provide the serial number of the disk. To locate the serial number, open the case and take out the failed disk (see the following sections for replacement instructions for your disk model).

If the disk is no longer under warranty, you can obtain a disk of the same capacity or larger from your ReadyNAS retailer.

Replacing a Failed Disk

When a Disk Status LED blinks slowly, it is an indication of a failed disk. ReadyNAS supports hot swap bays, so there is no need to power down the device.

To replace the disk:

1. Open the disk bay door.

2. Press the button under the failed disk. The latch pops out.



Figure 6-5

3. Pull out the disk tray and remove the screws.

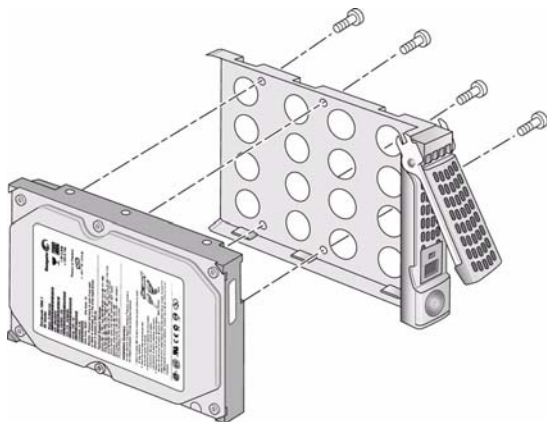

Figure 6-6

- If you want to prevent easy removal of the disk from the tray, set the tray lock: up is locked; down is unlocked.

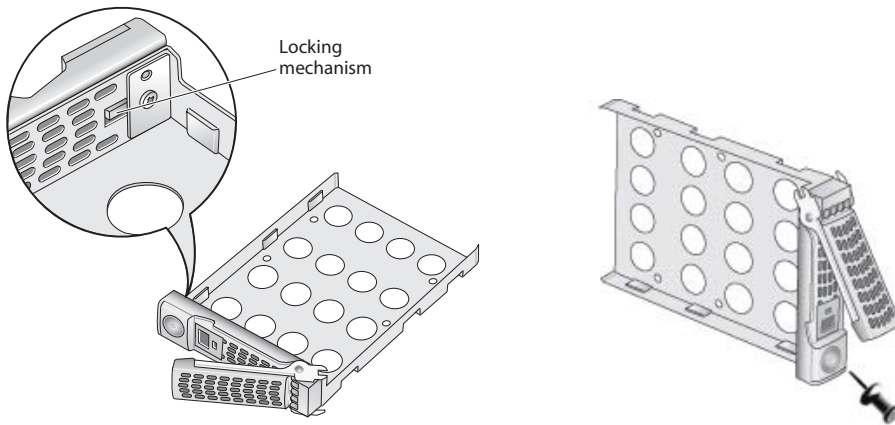

Figure 6-7



Note: If you set the tray lock, you will need to use a push-pin or paper clip to open the tray.

- Replace the failed disk, reassemble, and slide the disk tray back in. Make sure that the hard disk connectors face the interior of the disk bay when you reassemble the disk.

Resynchronizing the Volume

If you had to power off to replace the failed disk, turn on the power on the ReadyNAS.

The RAID volume automatically resynchronizes with the new disk in the background. The process takes several hours depending on disk size. During the resync process, the ReadyNAS can be used as normal, although access will be slower until the volume is finished resynchronizing.

You will be notified by e-mail when the resync process is complete.

Using the System Diagnostic Menu

The recessed reset switch on the back of the unit (see the illustration [“Rear Panel” on page 1-6](#)) allows you to perform six functions:

1. **Normal:** Bypass the diagnostic menu and perform a normal boot.
2. **Factory Default:** Reset the ReadyNAS back to factory default state, erasing all data on the disks. This option can be used to change between X-RAID2 and Flex-RAID mode.



Warning: This process reinstalls the firmware and resets all disk configurations, *wiping out any data* you might have on the NAS.

3. **OS Reinstall:** While keeping the data volume in tact, re-install the RAIDiator firmware on the ReadyNAS, reset the admin password and change the DHCP assignment to DHCP client. This is helpful if you have lost your admin password and want to set it back to default, if errors in your network settings has made it impossible to connect to the ReadyNAS, or if you suspect that the operating system on your disk may somehow be corrupt.



Tip: If possible, use the configuration backup (see [“Configuration Backup” on page 2-28](#)) to save your configuration so that if you have to reset the unit to its factory default settings, you can simply restore all your settings from the configuration backup.

4. **Tech Support:** Enable the remote diagnostic function.
5. **Skip Volume Check:** Boot the system but bypass the volume check.
6. **Memory Test:** Perform a memory diagnostic.

Typically, if you find that a configuration change makes the unit inaccessible, you can use option (3) to set the unit back to a factory default state.

Use the OS REINSTALL Option to Re-install the Firmware

To Re-install the RAIDiator firmware on the ReadyNAS without touching the data volume, follow these steps.

1. Power off the device.
2. While using a paper clip or push pin to press in the reset switch, power on the unit and hold the reset switch for a few seconds until the boot menu appears, then release the reset switch.

The OLED will display the reset menu.

3. Push the Backup button the front panel to scroll through the menu to the **OS Reinstall** option.

4. Press the recessed reset button at the back to confirm the menu selection and proceed to that option.

The system will boot reset to the factory default settings.

Configuring RAID

You can switch between the X-RAID2 Expandable Volume mode and the RAID 0/1/5/6 Flexible Volume mode only if you want to change the default configuration. It is not necessary to perform this procedure every time you boot up the system. The device remains in the selected mode until explicitly changed.



Warning: Performing a Factory Default will erase all your data on the hard disks. To preserve your data, do a full backup before using the Factory default option.

To reconfigure your RAID setup:

1. Power off the device.
2. While using a paper clip or push pin to press in the reset switch, power on the unit and hold the reset switch for a few seconds until the boot menu appears, then release the reset switch.
3. Push the Backup button on the front panel to scroll through the menu to the Factory Default option.
4. Press the recessed reset button at the back to confirm the menu selection and proceed to that option.

The system will reset to the factory default settings, and erase all the data on the disks.

5. Open RAIDar. RAIDar will prompt you to click **Setup**. The ReadyNAS Volume Setup screen displays.
6. Select either the **Expandable Volume (X-RAID2)** or the **Volume (RAID 0,1,5, 6)** radio button and click **Create Volume Now**. The volume and initialization process begins.



Warning: If no action is taken within 10 minutes, the system defaults to X-RAID2.

Shutdown

The Shutdown Options screen offers the option to either power off or reboot the ReadyNAS Pro Pioneer Edition device. You also have the option of performing either a full file system check or a quota check on the next boot. Both these options can take several minutes to several hours depending on the size of your volume and the number of files in the volume. You do not need to select these options unless you suspect there might be data or quota integrity problems.

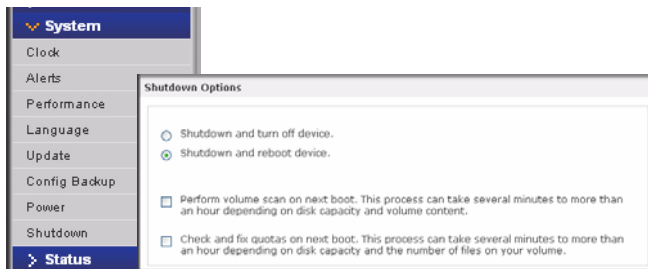

Figure 6-8

When you reboot or shut down the ReadyNAS Pro Pioneer Edition, you must close the browser window and use RAIDar to reconnect to FrontView.

Appendix A

Share Access from MAC and Linux Systems

This appendix presents examples of how shares on the ReadyNAS device can be accessed by the various MAC operating systems.

MAC OS X

To access the same share over AFP with OS X, select Network from the Finder Go > Network menu.



Figure A-1

From here, there are two ways to access your AFP share, depending on how you have chosen to advertise your AFP share.

AFP over Bonjour

To access the AFP share advertised over Bonjour on Mac OS X, select Network from the Finder Go menu to see a listing of available networks.

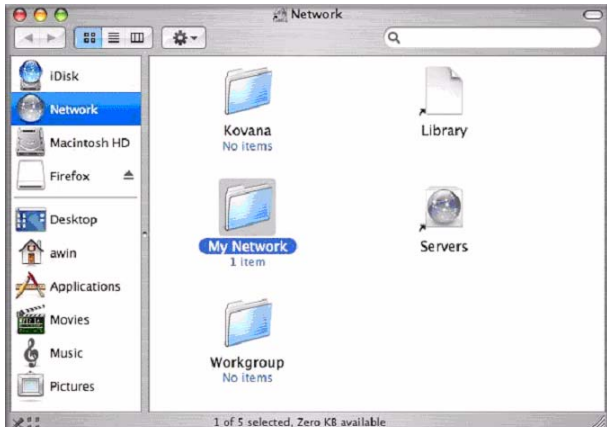

Figure A-2

Open the My Network folder to display the ReadyNAS hostname.



Figure A-3

Enter the user name and password you wish to use to connect to the ReadyNAS.

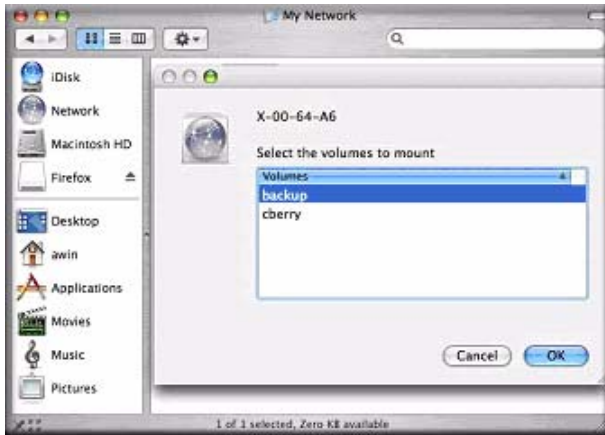
**Figure A-4**

From the Volumes field, select the share you want to access and click **OK**.

AFP over AppleTalk

If you chose to advertise your AFP service over AppleTalk, a listing of available networks is displayed.

**Figure A-5**

Open the My Network folder to display the ReadyNAS hostname. Select the one that has the hostname only. You are prompted with a connection box.



Figure A-6

Select **Guest** and click **Connect**. Then, select the share you want to connect to and click **OK**.



Figure A-7

If you have not set up a user name, enter the share name in place of the user name.

You should see the same file listing as you would in Windows Explorer.

MAC OS 9

To access the same share under Mac OS 9, select **Connect to Server** from the Finder menu, choose the NAS device entry from the AppleTalk section, and click **Connect**.

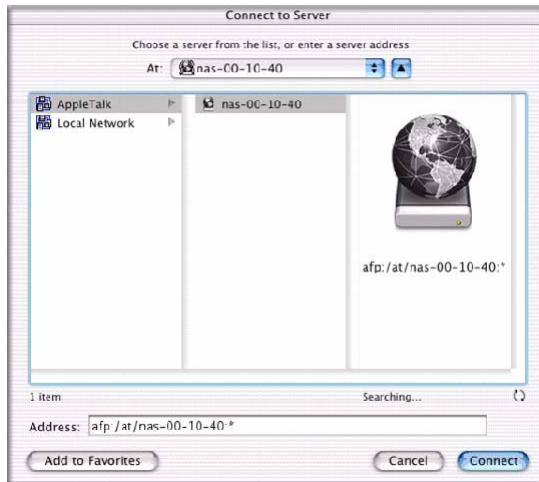

Figure A-8

Enter a valid **user account** and **password**, and click **Connect**.

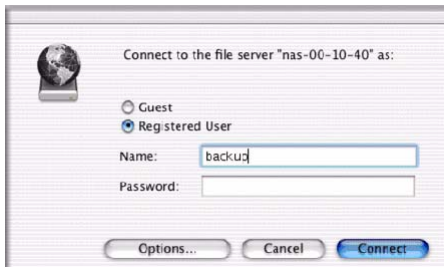

Figure A-9

If no share password is set in Share mode, you can select the **Guest** radio button and leave the **password** field blank. If your login is successful, are given a listing of one or more shares. Select the share you wish to connect to and click **OK**.

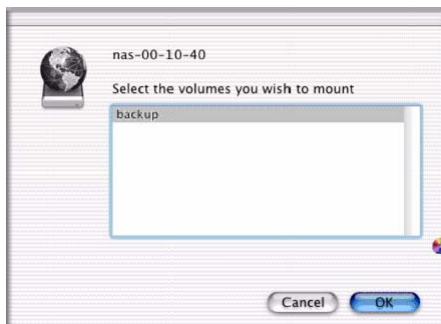

Figure A-10

You should see the same files in the share that you do in Windows Explorer.

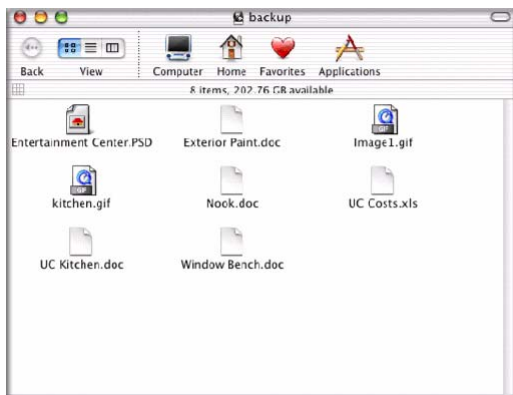
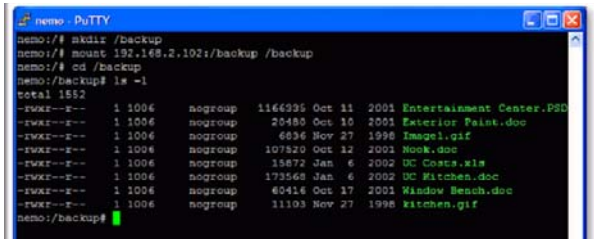

Figure A-11

Accessing Shares from Linux/Unix

To access this share from a Linux or Unix client where **backup** is the share name, you will need to mount the share over NFS by entering: `mount <ipaddr>:<backup /backup>`

Running the `ls` command in the mounted path displays the share content.



```

demo:PuTTY
demo:~# mkdir /backup
demo:~# mount 192.168.2.102:/backup /backup
demo:~# cd /backup
demo:/backup# ls -l
total 1552
-rwxr-xr-x  1 1006  nogroup  1164395 Oct 11  2001 Entertainment.Center.PSD
-rwxr-xr-x  1 1006  nogroup   20480 Oct 10  2001 Exterior.Paint.doc
-rwxr-xr-x  1 1006  nogroup    6836 Nov 27  1998 Image1.gif
-rwxr-xr-x  1 1006  nogroup  107820 Oct 12  2001 Menu.doc
-rwxr-xr-x  1 1006  nogroup   15872 Jan  6  2002 DC.Cases.xls
-rwxr-xr-x  1 1006  nogroup  173568 Jan  6  2002 DC.Kitchen.doc
-rwxr-xr-x  1 1006  nogroup   60416 Oct 17  2001 Window.Bench.doc
-rwxr-xr-x  1 1006  nogroup   11103 Nov 27  1998 kitchen.gif
demo:/backup#

```

Figure A-12



Note: The ReadyNAS does not support NIS as it is unable to correlate NIS information with CIFS logins. In mixed environments where you want CIFS and NFS integration, you can set the security to User mode and manually specify the UID and GID of the user and group accounts to match your NIS or other Linux/Unix server settings. The ReadyNAS can import a comma-delimited file containing the user and group information to coordinate Linux/Unix login settings.

Refer to [Appendix A, “Share Access from MAC and Linux Systems”](#) for instructions on accessing shares from various versions of the MAC OS.

Appendix B

Related Documents

This appendix provides links to reference documents you can use to gain a more complete understanding of the technologies used in your NETGEAR product.

Document	Link
Internet Networking and TCP/IP Addressing:	http://documentation.netgear.com/reference/enu/tcpip/index.htm
Wireless Communications:	http://documentation.netgear.com/reference/enu/wireless/index.htm
Preparing a Computer for Network Access:	http://documentation.netgear.com/reference/enu/wsdhcp/index.htm
Virtual Private Networking (VPN):	http://documentation.netgear.com/reference/enu/vpn/index.htm
Glossary	http://documentation.netgear.com/reference/enu/glossary/index.htm
Support	http://kbserver.netgear.com/
ReadyNAS Forum	http://www.readynas.com/
Hardware Compatibility List	http://www.readynas.com/?page_id=76

Numerics

1100 backup
USB 4-8

A

accessing shares
Linux/Unix A-7
MAC OS X A-1
over MAC OS 9 A-5
Web browser 3-12

account preferences
settings 3-6

Adding a Volume
Flex-RAID 2-15

admin user
password, setting of 2-6

Advanced Options 3-11

AFP 2-9
over AppleTalk A-3
over Bonjour A-2
share A-1

alerts
general settings 2-23
setting contacts 2-23

Apple File Protocol. See AFP.

AppleTalk
AFP A-3

B

Backup Button
programming 4-7

Backup Jobs
adding new 4-1
configuring 4-1

editing 4-8
options 4-5
scheduling 4-4, 4-6

Backup Log 4-8

Backup Manager 4-1

Bonjour
2-11
AFP A-2

C

changing between X-RAID and Flex-RAID 6-6

changing modes 2-18

CIFS 2-8
CIFS permission 3-9

Clock
NTP 2-22

Comma Separated Value. See CSV

Common Internet File Service. See CIFS.

CSV 3-5
format of 3-3

D

Default Gateway 2-4

Deleting a Volume
Flex-RAID 2-14

deployment
location 1-7

DHCP 2-5
enabling/disabling 2-6
settings 2-2

Digital Living Network. See DLNA.

Discovery Services 2-8
UPnP 2-11

- discovery services
 - Bonjour 2-11
- Disk Spin-Down 5-3
- DLNA 2-10
- DNS Settings 2-4
- DVD Players
 - networked 3-16

E

- Enable WebDAV support 3-20
- EXT3 2-19

F

- Factory Default Settings 2-28
- failed disk
 - ordering replacement disks 6-3
 - replacing on NV+ 6-3
 - replacing, how to 6-3
- FAT32 2-19
- File Transfer Protocol. See FTP.
- Flex-RAID 2-13, 2-14
 - adding a volume 2-15
 - deleting a volume 2-14
- frame size 2-3
- FrontView
 - accessing 1-9
- FTP 2-9
 - backup jobs 4-2

G

- groups
 - accounts, creating 3-2
 - managing 3-2

H

- health
 - status of ReadyNAS 6-1
- Home Media Streaming Server 2-10
- home share

- accounts/preference, creating 3-2
 - user 3-2
- Hostname 2-4
 - default 2-4
 - setting 2-4
- hot spare 2-16
- Hypertext Transfer Protocol. See HTTP.
- HTTP 2-9
- HTTPS
 - with SSL encryption 2-9

I

- import users
 - user accounts 3-5
- IP address
 - setting 2-2
 - static, setting 2-2
- iTunes Streaming Server 2-10

J

- jumbo frames
 - performance settings 2-3

L

- Language
 - settings 2-24
 - Unicode 2-25
- Linux/Unix
 - accessing shares A-7
- Logs 6-2

M

- MAC address
 - host name use 2-4
- MAC OS 9
 - accessing shares A-5
- MAC OS X
 - accessing shares A-1
- MTU 2-3
- multi-media 2-10

SlimServer 2-10
streaming services 2-10

N

Network File Service. See NFS.
networking
 DVD players 3-16
 UPnP AV Media Adapters 3-16
NFS 2-8
NFS server
 backup jobs 4-2
NTP
 clock 2-22
NV+
 replacing disk 6-3

P

password
 changing 3-6
 recovery of 2-7
 setting admin user 2-6
performance
 fine-tuning 5-1
 settings, jumbo frames 2-3
Power Management 5-3
Power Timer 5-4
print queues
 managing 2-21
Printers
 setting up 2-20
 USB 2-20
Printing
 CIFS/SMB 2-20
 IPP 2-21

R

RAID
 setup, reconfiguring 6-7
RAID Level
 X-RAID 2-13
RAID Level 0 2-12

RAID Level 1 2-12
RAID Level 5 2-12
RAID Settings 2-15
ReadyNAS
 health 6-1
 updating 2-25
 viewing Logs 6-2
replacement disks
 ordering 6-3
resynchronizing volume 6-5
Rsync 2-9
 server, backup jobs 4-2

S

shares
 access restriction, domain mode 3-9
 adding 3-7
 advanced CIFS permission 3-9
 display option, domain mode 3-9
 fine-tuning 3-8
 managing 3-7
 selecting services 2-8
 setting access in Domain Mode 3-9
Shutdown 6-8
SlimServer 2-10
SMART+Self-Monitoring, Analysis and Reporting
 Technology. See SMART+.
SMB 2-8
SMTP 2-24
Speed/Duplex Mode 2-2
Squeezebox 2-10
Standard File Protocols 2-8
streaming services 2-8
 Home Media Streaming Server 2-10
 iTunes Stream Server 2-10
 multi-media 2-10
 SlimServer 2-10
 UPnP AV 2-10
Support 1-ii

U

- UBB
 - 1100 backup 4-8
- Unicode 2-25
 - HTTP 2-25
 - WebDAV 2-25
- updating
 - remote method 2-26
- updating ReadyNAS 2-25
- UPnP 2-11
- UPnP AV 2-10
- UPnP AV Media Adapters
 - networked 3-16
- UPS
 - configuration of 5-4
 - performance, adding 5-2
- USB 2-19
 - backing up to 4-8
 - flash device 2-19
 - formats, EXT3 2-19
 - formats, FAT32 2-19
 - shares 2-18
 - storage 2-18
- USB storage
 - partitions 2-18
- user
 - accounts, creating 3-2
- user accounts
 - import users 3-5
 - managing 3-4

V

- Volume Management 2-11
 - X-RAID 2-14
 - Flex-RAID 2-13
 - X-RAID 2-16
- VPN
 - setting WINS server 2-5

W

- Web browser
 - accessing shares 3-12
- WINS
 - 2-5
- workgroup
 - name 3-2

X

- X-RAID 2-14
 - adding a second disk 2-16
 - adding more disks 2-16
 - RAID Level X 2-13
 - redundancy overhead 1-3
 - using hot-swap trays 2-17
 - volume management 2-16