

# ZANUSSI

## DISHWASHER DCE 5655

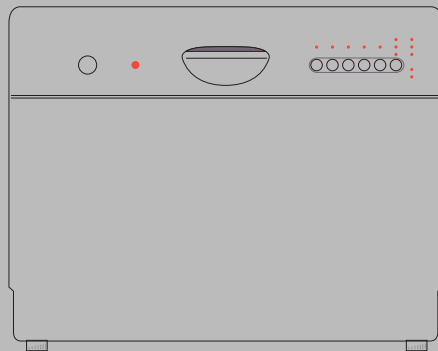

# Contents

## For the user

<b>Safety Information</b>	<b>3</b>
<b>Description of the appliance</b>	<b>4-5</b>
- Spray arm	
- Coarse strainer/microfilter	
- Fine filter	
- Detergent dispenser	
- Rinse aid dispenser	
- Water softener	
<b>The control panel</b>	<b>6</b>
- How to set the delayed start	
<b>Adjusting the water softener</b>	<b>7</b>
<b>Programme chart</b>	<b>8</b>
<b>Using the appliance</b>	<b>9</b>
- Starting the programme	
- Stopping the programme temporarily	
- Cancelling the programme	
- Pause function	
- Cancelling the drying phase	
- Switching the dishwasher off	
<b>Loading and unloading</b>	<b>10</b>
<b>Maintenance and cleaning</b>	<b>11</b>
<b>Something Not Working</b>	<b>12</b>
<b>Service</b>	<b>13</b>
- Service and Spare Parts	
- Customer Care Department	
<b>Information for test centres</b>	<b>13</b>
<b>Guarantee Conditions</b>	<b>14</b>

## For the Installer

<b>Technical Specifications</b>	<b>15</b>
<b>Unpacking</b>	<b>16</b>
- Damages	
- Use	
- Identification of materials	
<b>Installation</b>	<b>17</b>
- Positioning	
- Water inlet	
- Water drainage	
- Power supply	

## Guide to use the instruction book

The following symbols will be found in the text to guide you throughout the instructions:



**Safety information**



**Step by step instructions**



**Hints and tips**



**Environmental information**

# Safety information

**Before installing and first using the dishwasher, read this instruction booklet carefully, including its hints and warnings. To avoid unnecessary mistakes and accidents, it is important to ensure that all people using the dishwasher are thoroughly familiar with its operation and safety features. Save these instructions and make sure they remain with the dishwasher if it is moved or sold, so that everyone using it through its life can be properly informed on appliance use and safety.**

## Installation and servicing

- All installation and service work done on the product must be carried out by a qualified technician. Work performed by persons with inadequate knowledge may adversely affect the satisfactory functioning of the product and may cause personal injury or damage. Before any work is carried out on the dishwasher, it must be isolated from the electrical supply. To do this the power plug must be removed from the wall socket.
  - Water connection shall be made via an easily accessible stopcock.
  - The power cable must be plugged into an earthed socket, which need to be easily accessible. Permanent installation must only be carried out by an authorized electrician.
  - Make sure that the power cable is not nipped or otherwise damaged and that the hoses do not get crushed or kinked when moving the dishwasher in connection with installation or cleaning etc.
  - Servicing and possible repairs must be carried out by a service company authorized by the supplier. Use only spare parts supplied by these. Never try to repair the dishwasher yourself.
- If you take any dishes out of the dishwasher before the end of the dishwashing cycle, it is extremely important to rinse them thoroughly under running water to remove any remaining detergent.
  - The water safety system protects against water damages. The following requirements must be fulfilled:
    - The dishwasher must be electrically connected when it is shut off.
    - The dishwasher must be correctly installed.
    - Always shut off the water supply whenever the dishwasher is left unattended for an extended period.
  - In the event of flooding or leakage, shut off the water supply immediately by closing the stopcock and disconnect the power supply by unplugging the power cord or removing the fuse. When removing the electrical plug, grip the plug, not the lead.

## Child Safety

- The dishwasher should be used by adults only. Do not let children play with the controls or other parts of it.
- Remember that the plastic bags included in the packaging can be fatal playthings for small children.
- Keep all detergents in safe place out of children's reach.
- Prevent children from sitting, swinging or standing on the open door.

## During Use

- This dishwasher is designed solely for washing household utensils suitable for machine washing. Using it for other purposes could lead to physical injury or damage to property and invalidate the guarantee.
- Avoid opening the door while the dishwasher is running, as hot steam may escape.
- Only use detergent specifically designed for use in dishwashers.
- Do not place sharp knives with their points upwards. It is much safer to lay them horizontally in the basket.

## Conservation

### - packaging:

All materials used in packaging this appliance are environmentally-friendly. The various plastics used are identified and can be recycled.

### - old apparatus:

At the end of the appliance's useful life, disconnect the electrical plug from the power supply, then cut the electrical cable at the point where it enters the appliance. Make quite sure that children will not be able to play with it.

# Description of the appliance

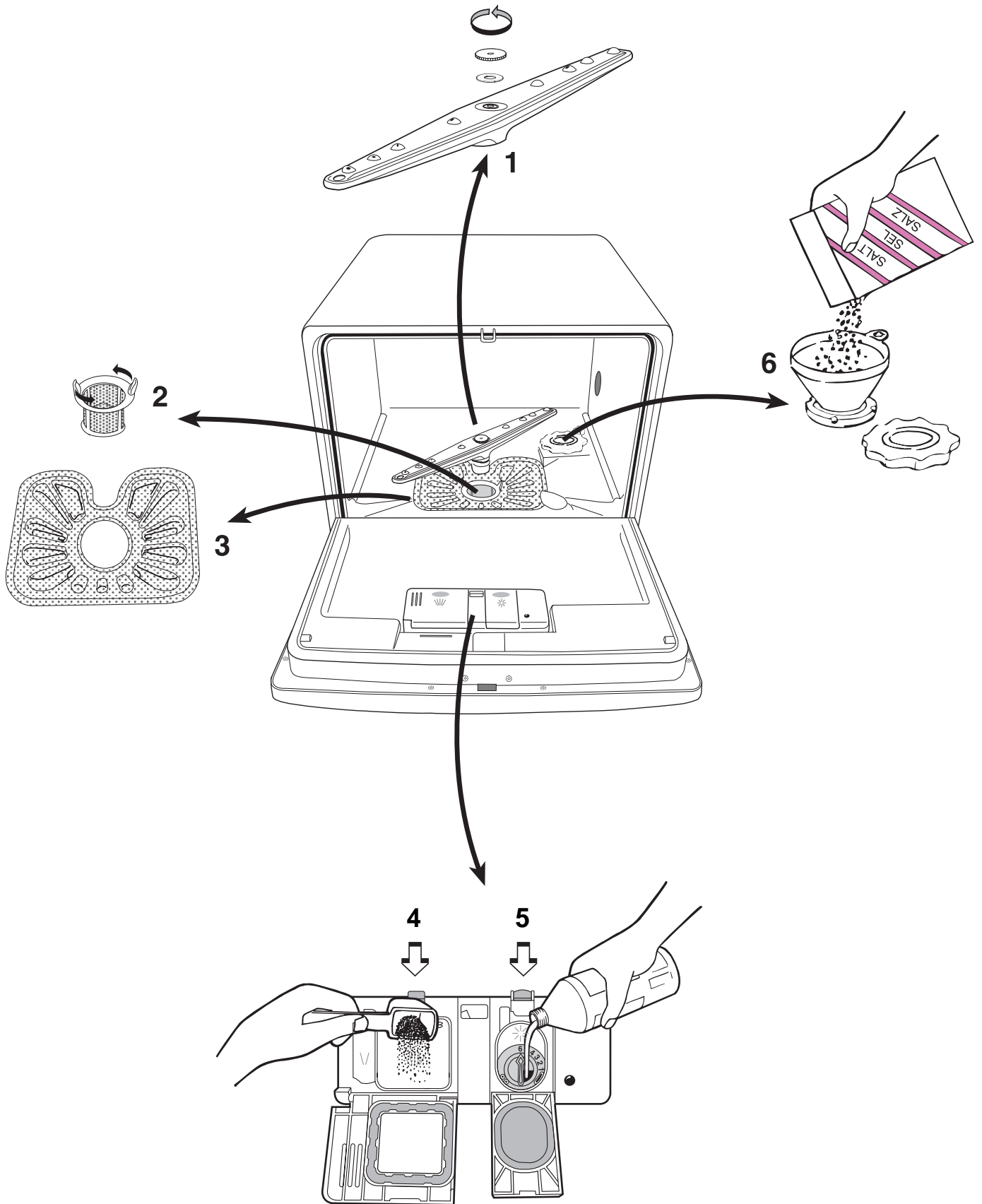

## Spray arm (1)

It is important to keep all the holes in the spray arm clear. A clogged hole can seriously affect washing efficiency. If the spray arm needs cleaning, unscrew the nut anti-clockwise, remove the washer and lift off the spray arm. Clear the holes and shake out any food remnants.

## Coarse strainer/microfilter (2)

The purpose of the coarse strainer is to catch large objects such as toothpicks and pieces of eggshell. Make sure that the strainer is always clean. Turn the coarse strainer anti-clockwise. Lift it out and rinse it under running water whenever necessary.

## Fine filter (3)

It is just as important to keep this filter clean. A dirty or clogged filter will always impair washing efficiency. The fine filter can easily be lifted out for cleaning when you have removed the coarse strainer.

## Detergent dispenser (4)

Open the lid to the dispenser by pressing the lid catch towards the compartment. Consult the instructions on the detergent packet, fill the compartment accordingly and close the lid. Pre-wash detergent is poured into the smaller compartment to the left when needed. This detergent is active already at pre-rinsing. Make sure that there is no items that prevents the lid from opening.



Only use detergents specially designed for dishwashers.

## Rinse aid dispenser (5)

Use of rinse aid will result in cleaner and faster drying of the load, since it helps water and soil to run off. Too much rinse aid may result in streakiness, too little may cause white spots. The dispenser holds about 150 ml. This is enough for approx. 60 wash cycles, depending on the dosage setting. Adjust the dosage setting according to the hardness of the water.



You can set the dosage between 1 - 6, the appliance is factory set to 1. Begin at the lowest dosage setting and increase if necessary by turning the setting arrow with e.g. the handle of a spoon.

The  indicator light on the control panel is lit when the dispenser requires refilling.



1. Open the lid to the dispenser by pressing the lid catch towards the compartment and lift the lid.
2. Fill up with rinse aid; do not overfill.
3. Wipe off any spillage carefully to prevent excessive foaming during the next wash programme.
4. Close the lid and press until it locks again.



Do not fill the rinse aid dispenser with liquid detergent.



Zanussi recommends the use of Finish dishwasher detergent and Rinse Aid.

## Water softener (6)

This dishwasher is equipped with a water softener for hard water. The lime in hard water causes white deposits to occur on dishes and to the interior of the dishwasher. To prevent this, the water has to pass through a special container where the hardness is removed. Since the water softener uses coarse dishwasher salt, you will have to refill the salt container after a certain number of dishwasher cycles.



It is extremely important, that the salt container is filled up with the coarse dishwasher salt before using the dishwasher for the first time.

The  indicator light on the control panel is lit when the container requires refilling.



1. Unscrew the filler cap to the salt container anti-clockwise.
2. Fill the salt container with water (only the first time).
3. Fill the container with dishwasher salt, using the funnel supplied.
4. Remove the funnel and wipe off any spillage around the filler opening.
5. Screw the filler cap back properly in place.

The water softener is now ready for the first load of dishes. Always make sure that there is coarse dishwasher salt in the container, which holds about 1 litre. To adjust the water softener, see page 7.



Only use special salt for dishwashing machines, ordinary domestic salt, especially table salt, can damage the water softener.

# The control panel

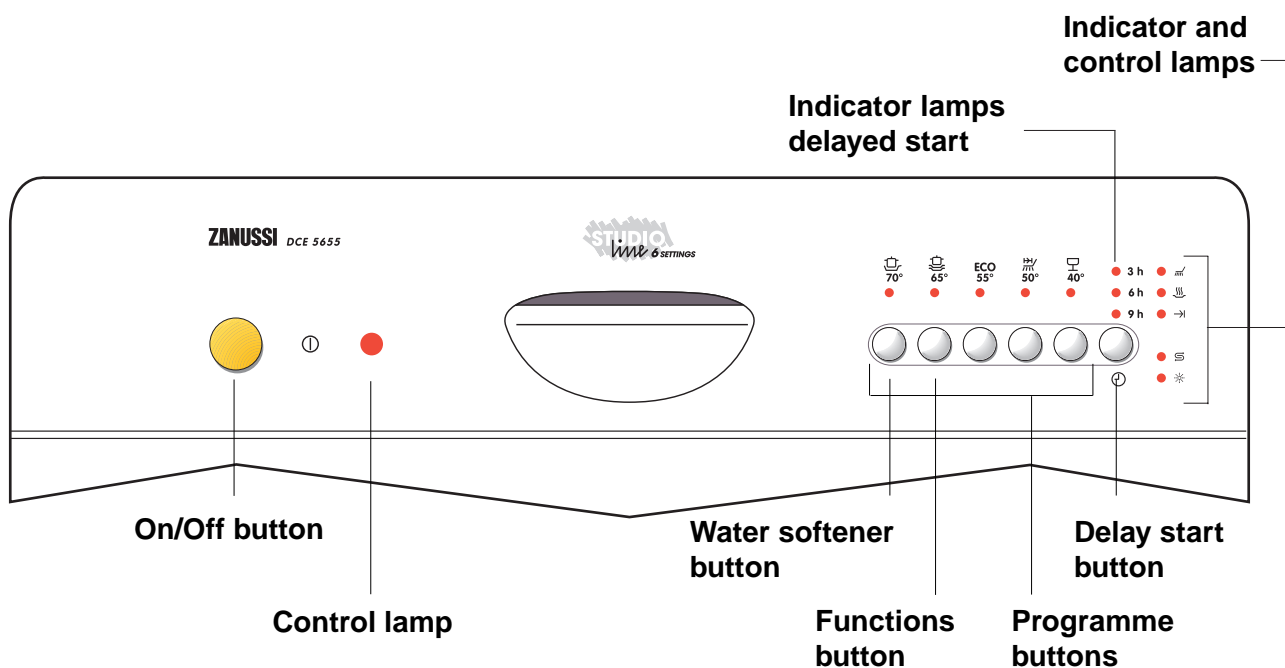



## Water softener and functions button:

In addition to selecting a programme you can press these two buttons to adjust the setting of the water softener.



## Indicator lamps:

Shows

- Current phase of the selected programme.
- Wash cycle in progress  top lamp
- Drying in progress  middle lamp
- Programme cycle ended  lowest lamp

## Control lamps:

Shows that

- On/Off button is pushed in 
- Refilling of salt container is necessary 
- Refilling of the rinse aid dispenser is necessary 

## How to set the delayed start

The programme start can be delayed by 3, 6 or 9 hours.

1. Press in the On/Off button.
2. Press the delay start button repeatedly, until the lamp next to the required hours of delay is lit.
3. Press the button for the required programme.
4. After the set delayed start time has elapsed, the programme starts.

## Reset the delayed start:

If the programme has not started, you can change the set time with the delayed start button.

## Cancelling the delayed start:

If the programme has not started, the delayed start can be cancelled. Press the delay start button repeatedly, until none of the lamps next to the hours are lit. The required programme starts immediately.

# Adjusting the water softener

To prevent limescaling on the dishes and to the interior of the dishwasher, the dishes must be washed with soft water.

This dishwasher is equipped with a water softener, where tap-water which is harder than 4 °d (german degree) is softened.

Adjust the water softener according to the table below for the water hardness level for your area.

 Contact your local Water Authority to find the exact water hardness level for your area.

The water softener has 5 settings:

Water hardness level		Setting on the water softener	Number of light flashes
i °d 1)	i mmol/l 2)		
> 24	4,2	5	5
18 - 24	3,2 - 4,2	4	4
12 - 18	2,1 - 3,2	3	3
4 - 12	0,7 - 2,1	2*	2
below 4	below 0,7	1 no salt is needed	1

 In both of the following settings the dishwasher must be switched off and all programmes completed. See page 9 for the programme cycles.

-  1. Press the water softener and functions buttons simultaneously and hold them pressed in, then also press in the On/Off button.
2. When the lamps for the water softener and functions buttons starts to flash, you can let go of the buttons.
3. Press the water softener button once. At first the lamp will be solid, then it starts to flash.
- The number of flashes are equivalent with the set water hardness level.
  - This sequence of flashes is repeated several times after a few seconds pause.
4. The water hardness level is raised by 1 step every time you press the water softener button.

-  After hardness level 5 comes hardness level 1.
5. Press the On/Off button when the required water hardness level is selected. This saves the selection.

 If the setting 1 is chosen, the salt indicator lamp is not lit.

 If dishwasher detergent with rinse aid is used, you can switch off the lamp that indicates that the rinse aid dispenser is empty.

-  1. Press the water softener and functions buttons simultaneously and hold them pressed in, then also press in the On/Off button.
2. When the lamps for the water softener and functions buttons starts to flash, you can let go of the buttons.
3. Press the functions button once. The lamps for the functions button and ended programme cycle starts to flash. Press the button once more and the light for the ended programme cycle goes out. Now the function for the rinse aid control light is off.
4. Press out the On/Off button to complete the setting.





 To reset the function, follow steps 1 and 2 above and then press the functions button twice, until the lights for the functions button and for ended programme cycle begin to flash again.

1) german degree of measurement for the water hardness

2) millimol, international unit for water hardness

\*) factory setting

# Programme chart

Type of dishes	Plates and cooking pots	All types of dishes			Coffee cups, delicate items
<b>Type of soil:</b>	<ul style="list-style-type: none"> <li>heavily soiled</li> <li>dried-on food remnants especially egg-white and starch</li> </ul>	<ul style="list-style-type: none"> <li>normaly soiled</li> <li>dried-on food remnants</li> </ul>	<ul style="list-style-type: none"> <li>normaly soiled</li> </ul>	<ul style="list-style-type: none"> <li>lightly soiled</li> </ul>	<ul style="list-style-type: none"> <li>lightly soiled</li> </ul>
<b>Suitable programme:</b>	↓	↓	↓	↓	↓
	 <b>INTENSIVE</b> 70° C	 <b>NORMAL</b> 65° C	<b>ECO</b> <b>ENERGY SAVE</b> 55° C <sup>3)</sup>	 <b>QUICK</b> 50° C	 <b>GLASS</b> 40° C
<b>Programme cycle:</b> 1)	Pre-wash Washing 2 x rinses Final rinse Drying	Pre-wash Washing Rinse Final rinse Drying	Pre-wash Washing Rinse Final rinse Drying	- Washing Rinse Final rinse -	- Washing Rinse Final rinse -
<b>Consumption figures:</b> 2)	↓	↓	↓	↓	↓
<b>Washing time with drying:</b>	112 minutes	92 minutes	150 minutes	35 minutes	30 minutes
<b>Drying time:</b>	12 minutes	12 minutes	50 minutes	—	—
<b>Energy:</b>	1,15 kWh	0,80 kWh	0,63 kWh	0,40 kWh	0,35 kWh
<b>Water:</b>	9 litres	7 litres	7 litres	6 litres	6 litres

1) Different parts of the wash programme may not sound the same, because the wash action is more intensive at some stages.

2) Consumption figures have been calculated for nominal conditions. The figures can vary depending on inlet water temperature and how full the main and cutlery basket are.

3) Consumption figures and performance is according to the Energy Save programme cycle.

 All programme cycles begins with a drainage.

 Dishwashing detergent in tablet form is not suitable for use in the Quick- and Glass programme cycles.



# Using the appliance

## Starting the programme

-  1. Scrape or rinse off solid food remnants.
2. Load the dishwasher.  
(See the basket and loading in page 10).
3. Put the correct amount of detergent into the detergent dispenser and close the dispenser lid.
4. Close the door.
5. Press in the On/Off button.
6. Press in the required programme button (see programme chart). Programme indicator lamp is lit. During the six seconds the two top indicator lamps are flashing, you can select another programme cycle. If not, the selected programme starts. The lamp indicates which part of the selected cycle the dishwasher is in.
7. Check the strainers/filters to see if they need to be cleaned when the dishwasher has finished the programme.

 If both the top and middle indicator lights are flashing, first check that the door is properly closed, if it is read the section "Something Not Working".

## Stopping the programme temporarily

-  1. Open the door. The programme stops.
2. Top or middle indicator lamp is flashing depending on how far the programme cycle has gone.
3. Close the door and the programme continues after about 6 seconds.

 Open the door carefully when the dishwasher is running, since hot steam may escape.

## Cancelling the programme

-  1. Press and hold in the button for the programme in progress until the indicator light for the programme goes out.
2. Release the programme button. The programme is now cancelled and a new programme can be selected.

 If you switch the dishwasher off, the selected programme is not finished, it is only paused. When you start the dishwasher again, the programme will continue.

## Pause function

With the pause function the programme can be temporarily disrupted for a short period of time.

-  1. Press in the On/Off button. The programme stops.
2. All lamps goes out.
3. When you want the programme to continue again, you press the On/Off button. The programme continues.



The programme should not be paused for any longer than necessary, because the water inside the dishwasher has cooled down and must be heated again which increases the power consumption.

## Cancelling the drying phase

In case you do not want to wait until the drying phase is completed, you can cancel it.

-  1. Press in the On/Off button. The control lamp for the On/Off button goes out.
2. Open the door. The drying phase is cancelled.

## Switching the dishwasher off

Do not switch the dishwasher off until the indicator lamp  for the programme cycle end is lit.

-  1. Press in the On/Off button. The control lamp for the On/Off button goes out.



Be careful if you open the door immediately after the programme is finished, since hot steam may escape.



This dishwasher has a new feature called "IMPULSE WASHING". This washing system varies both the revolutions of the pump and the water pressure for more intensive cleaning of the dishes during a programme. That is why different sections of the programme cycle do not sounds the same.

# Loading and unloading the dishwasher

## How to load the dishes

The illustration shows the dishwasher loaded with six place settings. Your own dishes are not likely to be identical to this load, but if you follow the advice below we are sure you will be pleased with the results.

- Always place glasses, cups and bowls upside down.
- Incline deep dishes (soup plates etc.) so that the water can run off when drying.
- Make sure that the dishes do not rest against each other. This is particularly important in regard to the cutlery basket - nested spoons, etc. simply cannot be properly washed. The water must get at all the soiled surfaces.
- Make sure that cutlery with slender handles and other items do not protrude through the openings in the basket and prevent the spray arm from rotating.
- Never put silver and stainless steel objects together. When these metals come into contact with each other a chemical reaction occurs which stains the silver.
- China with a pattern applied on top of the glaze may not be suitable for machine washing as the colours may fade and lose their lustre. The same applies to cutlery with wooden or plastic handles.

**i** Make sure you always buy articles that are dishwasher proof.

- Silver and aluminum items tend to be discolour when washed. Food remnants from egg and mustard often causes discolourations and stains on silver. Make sure to rinse off and remove food remnants on silver if it is not washed immediately after it has been used.
- Not all plastic articles are machine washable. If you are in doubt as to whether your plasticware can be machine washed, we suggest you check by washing a single item or else wash them by hand.
- When washing delicate items, select the programme with the lower wash temperature.
- Substances such as ketchup containing strong colouring agents can cause temporary discolouration to the interior of the dishwasher.

**!** Do not place sharp knives with their points upwards. It is much safer to lay them horizontally in the main basket.

**i** If required, the top and the handle to the cutlery basket are removable.

## Baskets

Main basket  
Cutlery basket

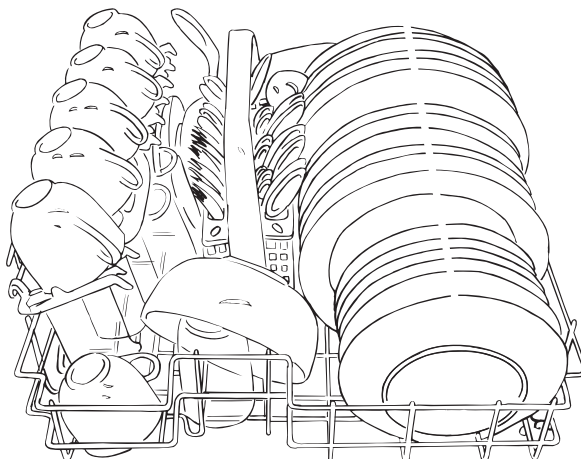

## Unloading

Hot dishes are sensitive to mechanical shocks. Always let the dishes cool down before unloading.

**i** The dishes dry faster if the door is opened slightly for a short time once the programme has finished.

# Maintenance and cleaning

## General cleaning

Inspect the filters and spray arm nozzle before re-loading the dishwasher and remove any food scraps. Wipe round the rubber gasket at the bottom of the door to remove grease which tends to collect there.

## Cleaning the filters

There are two filters, a coarse one and a fine one which should be cleaned after every wash. Lift out these filters which are in the base of the dishwasher and wash under running water.



The dishwasher must not be used without the filters. Incorrect repositioning of the filters will produce poor washing results.

Cleaning of the filters is vital to ensure correct operation of the dishwasher.

## Cleaning the spray arm nozzle

The holes in the spray arm nozzle must be kept free of scraps for the efficiency of the washing action. Inspect the spray arm regularly. When thorough cleaning is necessary, remove the spray arm by unscrewing the nut anti-clockwise, remove the washer and lift off the spray arm.

Wash the spray arm with hot soapy water using a stiff saucepan brush if necessary to remove scraps.

Re-assemble carefully, making sure the nut is secure.

## Cleaning the cabinet

Wipe the outside of the cabinet and control panel regularly with a soft damp cloth. When necessary, use washing up liquid to remove stubborn marks, rinse with a damp cloth and rub up with a soft duster.

Never use abrasive cleaners which could damage the surface, ie: scouring pads or solvents (acetone, trichloroethylene, etc).

If the dishwasher is not going to be used for some time, take the following precautions:



1. Unplug the dishwasher and turn off the water supply.
2. Fill up the rinse aid container.
3. Make sure the tub is clean by carrying out a wash programme (without any crockery) using Finish Dishwasher cleaner, then dry the inside thoroughly.
4. Leave the door ajar.

## Moving the dishwasher

If you have to move the dishwasher (you are moving house, etc):



1. Unplug it.
2. Turn off the water tap.
3. Remove the water inlet and discharge hoses.



Avoid tilting the dishwasher during transportation.

## Protecting the dishwasher against freezing



If the dishwasher is placed in an environment where the temperature sometimes fall below 0° C, there is a risk that the small amount of water which remains inside the parts of the dishwasher will freeze and damage it. To prevent this you should:



1. Turn off the water supply to the dishwasher.
2. Remove the water inlet and discharge hoses.
3. Make sure that there is dishwasher salt in the salt container for the water softener.



The appliance is only to be used and stored indoors at normal room temperature. The manufacture is not responsible for any frost damage.

# Something Not Working

Before calling out an engineer, please check through the details below because some faults can be rectified easily without the need to call out an engineer. If an engineer is called to resolve a problem listed below or to repair a fault caused by incorrect installation or mis-use a charge will be made, even if the appliance is under guarantee.

Fault	Check
<b>The programme will not start.</b>	<ul style="list-style-type: none"> <li>• Is the door closed properly?</li> <li>• Have you pressed the On/Off button?</li> <li>• Is the water tap turned on?</li> <li>• Is the dishwasher plugged in?</li> <li>• Has the fuse blown? (Start with fuse in electrical plug).</li> <li>• Is the delay start-button pressed in?</li> <li>• Is the previous programme finished? (<i>See page 9</i>).</li> </ul>
<b>The dishwasher is not filling with water.</b>	<ul style="list-style-type: none"> <li>• Is the water tap turned on?</li> <li>• Has your domestic water supply been cut off temporarily?</li> <li>• Is the water inlet hose kinked or blocked?</li> <li>• Is the filter inside the inlet hose blocked?</li> <li>• Is the water pressure too low?</li> </ul>
<b>Water not discharged at end of cycle.</b>	<ul style="list-style-type: none"> <li>• Did you open the door before the indicator light →  is lit and the programme cycle finished?</li> <li>• Is the previous programme finished? (<i>See page 9</i>).</li> <li>• Are the filters clogged?</li> </ul>
<b>Dishes not washed satisfactorily.</b>	<ul style="list-style-type: none"> <li>• Has anything prevented the spray arm from rotating?</li> <li>• Are the spray arm holes clogged?</li> <li>• Were the dishes packed too close together?</li> <li>• Are the filters clogged?</li> <li>• Are the filters fitted correctly in place?</li> <li>• Did you use enough detergent?</li> <li>• Is the salt container cap properly closed?</li> <li>• Did you select a programme with too low temperature?</li> <li>• Is the rinse aid dispenser empty?</li> </ul>
<b>Visible lime deposits or white film on the dishes.</b>	<ul style="list-style-type: none"> <li>• Is the salt container empty or is the water softener not correctly adjusted?</li> <li>• Is the rinse aid dispenser adjusted to too low dosage?</li> </ul>
<b>The dishwasher is noisy.</b>	<ul style="list-style-type: none"> <li>• Are the dishes rattling against each other?</li> <li>• Is the spray arm knocking against the dishes?</li> </ul>
<b>Whistling sound when washing.</b>	<ul style="list-style-type: none"> <li>• This is not a fault, try another brand of detergent.</li> </ul>
<b>The dishes are not quite dry and are not shiny.</b>	<ul style="list-style-type: none"> <li>• Is the rinse aid dispenser empty?</li> <li>• Have the dishes been left too long inside the dishwasher?</li> </ul>
<b>The door is difficult to close.</b>	<ul style="list-style-type: none"> <li>• Is the dishwasher level?</li> </ul>

If the top or middle indicator lamp is flashing, it is possible that you can solve the problem yourself. When the problem is solved, press in the On/Off button and the programme continues. If the problem occurs again, contact your local Service Force Centre. If any other lamps flash contact and inform your local Service Force Centre.

Fault	Check
<b>The top indicator lamp flashes.</b>	<ul style="list-style-type: none"> <li>• Is the water tap turned on?</li> <li>• Is the filter inside the inlet hose blocked?</li> <li>• Is the water inlet hose kinked or blocked?</li> </ul>
<b>The middle indicator lamp flashes.</b>	<ul style="list-style-type: none"> <li>• Is your domestic sewer system blocked?</li> </ul>

## Service and Spare Parts

In the event of your appliance requiring service, or if you wish to purchase spare parts, please contact your local Service Force Centre by telephoning:

**08705 929929**

Your telephone call will be automatically routed to the Service Force Centre covering your post code area.

For the address of your local Service Force Centre and further information about Service Force, please visit the website at [www.serviceforce.co.uk](http://www.serviceforce.co.uk)

Before calling out an engineer, please ensure you have read the details under the heading "In the event of a fault".

When you contact the Service Force Centre you will need to give the following details:

1. Your name, address and post code
2. Your telephone number
3. Clear and concise details of the fault
4. The model and serial number of the appliance (found on the rating plate)
5. The purchase date

**Please note that a valid purchase receipt or guarantee documentation is required for in-guarantee service calls.**



**Never attempt to repair the dishwasher yourself. Repairs carried out by unauthorized or inexperienced persons can cause injury or serious malfunctioning.**

## Customer Care Department

For general enquiries concerning your Zanussi appliance or for further information on Zanussi products, please contact our Customer Care Department by letter or telephone at the address below or visit our website at [www.zanussi.co.uk](http://www.zanussi.co.uk)

Customer Care Department  
Zanussi  
55-77 High Street  
Slough  
Berkshire  
SL1 1DZ  
Tel: 08705 727727 \*

\* call to this number may be recorded for training purposes.

## Information for test centres

The salt container and rinse aid dispenser shall be filled in accordance with this instruction manual. Before conducting the measurements the dishwasher shall be operated for one or two complete cycles using detergent and a clean load.

Test standard:	EN 50242 och EN 60704
Rated capacity:	6 place settings accordance EN 50242
Loading of basket:	accordance figure on page 10
Test program:	energy saving 55° C
Detergent (IEC type B):	15 gram in the dispenser + 3 gram in the pre-wash dispenser
Rinse aid (type III):	setting 3
Feed water pressure:	minimum 0,8 bar, maximum 10 bar

# Guarantee Conditions

## Standard guarantee conditions

We, Zanussi, undertake that if within 12 months of the date of the purchase this Zanussi appliance or any part thereof is proved to be defective by reason only of faulty workmanship or materials, we will, at our option repair or replace the same FREE OF CHARGE for labour, materials or carriage on condition that:

- The appliance has been correctly installed and used only on the electricity supply stated on the rating plate
- The appliance has been used for normal domestic purposes only, and in accordance with the manufacturer's instructions
- The appliance has not been serviced, maintained repaired, taken apart or tampered with by any person not authorised by us
- All service work under this guarantee must be undertaken by a Zanussi Service Force Centre
- Any appliance or defective part replaced shall become the Company's property
- This guarantee is in addition to your statutory and other legal rights

Home visits are made between **8.30am** and **5.30pm** Monday to Friday. Visits may be available outside these hours in which case a premium will be charged.

## Exclusions

**This guarantee does not cover:**

- Damage or calls resulting from transportation, improper use or neglect, the replacement of any light bulbs or removable parts of glass or plastic
- Costs incurred for calls to put right an appliance which is improperly installed or calls to appliances outside the United Kingdom
- Appliances found to be in use within a commercial environment, plus those which are the subject to rental agreements
- Products of Zanussi manufacture which are not marketed by Zanussi

## European Guarantee

If you should move to another country within Europe then your guarantee moves with you to your new home subject to the following qualifications:

- The guarantee starts from the date you first purchased your product
- The guarantee is for the same period and to the same extent for labour and parts as exists in the new country of use for this brand or range of products
- This guarantee relates to you and cannot be transferred to another user
- Your new home is within the European Community (EC) or European Free Trade Area
- The product is installed and used in accordance with our instructions and is only used domestically, i.e. a normal household
- The product is installed taking into account regulations in your new country

Before you move please contact your nearest Customer Care centre, listed below, to give them details of your new home. They will then ensure that the local Service Organisation is aware of your move and able to look after you and your appliances.

France	Senlis	+33 (0)3 44 62 29 99
Germany	Nurnberg	+49 (0)800 234 7378
Italy	Pordenone	+39 (0)0434 39 4700
Sweden	Stockholm	+46 (0)8 672 53 90
UK	Slough	+44 (0)1753 219897

# Installation instructions

 Any electrical work required to install this appliance, should be carried out by a qualified electrician or competent person.

 Any plumbing work required to install this appliance, should be carried out by a qualified plumber or competent person.

## Technical specifications

<b>Capacity:</b>	6 place settings accordance EN 50242	
<b>Dimensions:</b>	Height	447 mm
	Width	546 mm
	Depth (to the edge of the door)	480 mm
	Depth (to the middle of the door)	507 mm
<b>Weight:</b>	Net	22 kg
<b>Water pressures:</b>	Minimum	80 kPa (0,8 bar)
	Maximum	1000 kPa (10 bar)
<b>Water temperature:</b>	Maximum	65° C
<b>Electrical data:</b>	Power supply	230 V - 50 Hz
	Fuse	13 A
	Heating element	1000 W
	Power rating	1080 W



This appliance complies with the following E.E.C. directives:

- 73/23/EEC, dated 19.02.1973 – low-voltage directive.
- 89/336/EEC, dated 03.05.1989 (incl. amendment)
- 92/31/EEC) – directive on electromagnetic compatibility.

# Unpacking

## Damages

If the dishwasher has been damaged during transport, you should immediately notify the company responsible for delivering it.

Check that the dishwasher is undamaged. If you discover any damage, faults or that anything is missing, you should notify the dealer immediately.



Never leave packaging material in a place where children may play with it.

Check that the following accessories are supplied with the dishwasher when you unpack it:

- A funnel for filling salt (1)
- Elbow for discharge hose (2)
- Washer/filter for inlet hose (3)

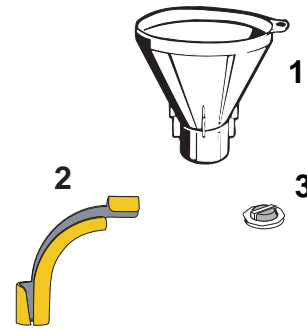

## Use

This dishwasher is designed solely for washing household utensils suitable for washing in a dishwasher. Using it for other purposes may damage it and invalidate the guarantee.

## Identification of materials



All materials used in packaging this appliance are environmentally-friendly. The various plastics used are identified and can be recycled:

- PE stands for polyethylene, which is used for the bag around the appliance and the bag in which these instructions were supplied.
- PS stands for polystyrene (moulded), which is used for the sections of packaging needed to cushion the appliance.

The cardboard components of the packaging are made from recyclable paper and should be taken to a collection point for recycling.

The appliance contains plastic and rubber components. These have identifying marks to show what they are made from, so they can be recycled or disposed of properly at the end of the appliance's life cycle.

The materials are identified according to international standards.



# Installation

## Positioning

The dishwasher is intended to be installed on a kitchen sink, worktop or built-in. To function properly, make sure that the appliance is level. Its height can be adjusted with the adjustable feet (5 mm each). See the illustration for built-in measurements.

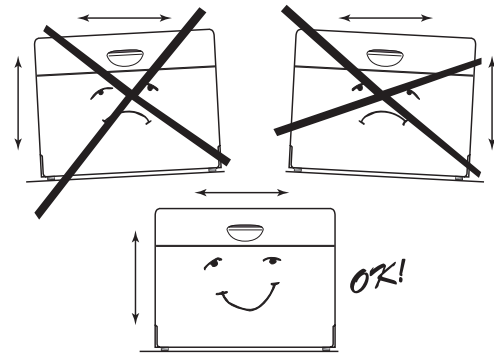

## Water inlet

**i** The dishwasher is equipped with safety features which are to prevent the water from going back to the fresh water system. These features are according to current water technical safety regulations.

The dishwasher should be permanently plumbed into a separate cold water supply.

The water pressure must be within the limits given in the technical specifications, as it will not function correctly if pressure is outside these specifications.

Your local Water Authority will advise you on the average mains pressure in your area. Where the water is supplied from a cold water cistern you can work out the pressure yourself by measuring the vertical distance (or 'Head') between the dishwasher's inlet hose and the outlet from the cold water storage cistern; allowing .86 psi for every 2 feet under normal conditions.

We would advise you to have a shut-off valve or stop-cock in the water supply pipe close to the dishwasher and accessible for easy use. This should be turned off when the appliance is not in use. Insert the combination rubber washer/filter and connect the inlet hose to a tap with a 3/4" pipe thread.

The inlet hose must not be joined onto any form of extension hose. If it is too short, the entire hose must be replaced with a longer high-pressure hose, specially designed for the purpose. The end of the hose, which is connected to the dishwasher can be turned in any direction. Loosen the retaining nut, turn the hose, then retighten the nut.

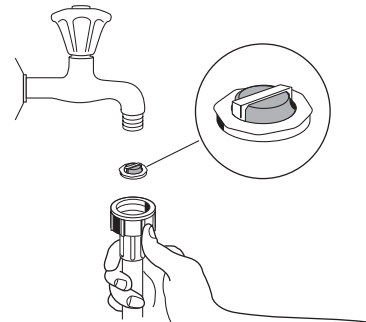
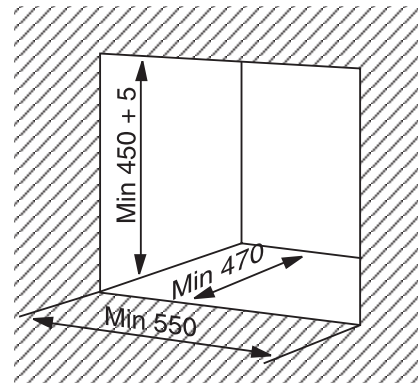

# Installation

## Water drainage

 To protect the dishwasher against water damage it is equipped with a water safety system. In the event of a fault the drain-pump starts automatically and the remaining water inside the dishwasher is pumped out.

 The water safety system also works when the dishwasher is switched off. However the dishwasher must be connected electrically.

Place the discharge hose over the sink as illustrated. It must not at any point be higher up than 75 cm over the surface which the dishwasher is standing on. If it runs higher, operation of the dishwasher might be impaired.

It is also important to ensure that the inside diameter of the hose is not less than 13 mm at any point. If the discharge hose is too long, it can easily be cut to the right length.

-  1. Cut the hose to a suitable length, using a sharp knife.
- 2. Fit the elbow supplied onto the end of the hose.

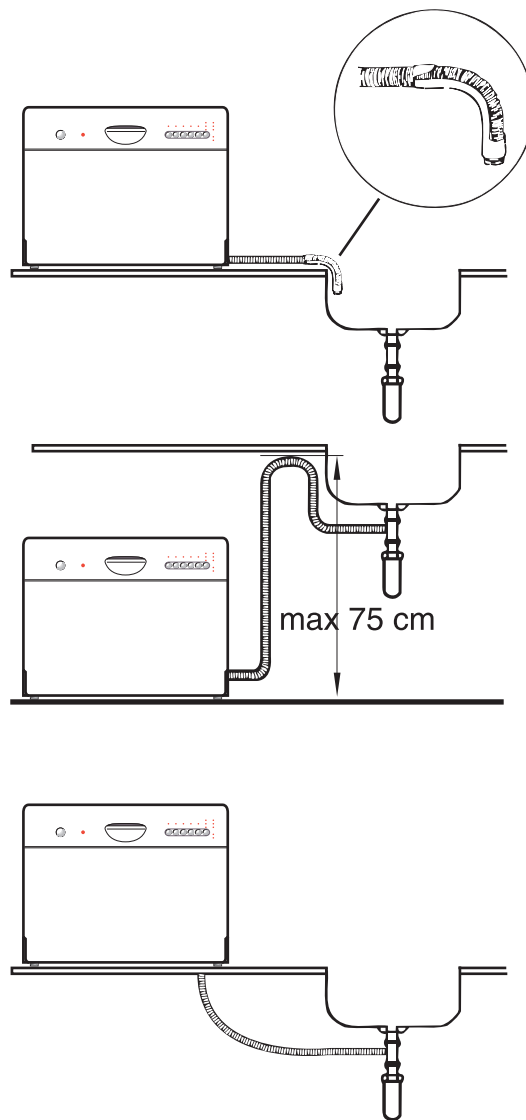

## Power supply

The dishwasher is supplied with a lead and electrical plug for connection to a 230 V, 13 A earthed wall socket. Before any work is carried out on the dishwasher, it must be isolated from the electric mains supply, for example by removing the plug from the wall socket.



**Permanent electrical installation must be carried out by an authorised electrician or competent person.**

**WARNING: THIS APPLIANCE MUST BE EARTHED.**

**The manufacturer declines any liability should this safety measure not be observed.**

If the plug that is fitted to your appliance is not suitable for your socket outlet, it must be cut off and the appropriate plug fitted.

Remove the fuse from the cut off plug.

The cut off plug should then be disposed of to prevent the hazard of shocks in case it should be plugged into a 13 amp socket in another part of your home.

### Important

The wires in the mains lead are coloured in accordance with the following code:

- Green and Yellow** - Earth
- Blue** - Neutral
- Brown** - Live

If you fit your own plug, the colours of the wires in the mains lead of your appliance may not correspond with the markings identifying the terminals in your plug, proceed as follows:

Connect the Green and Yellow (earth) wire to the terminal in the plug which is marked with the letter «E» or the earth symbol  $\oplus$  or coloured green and yellow.

Connect the blue (neutral) wire to the terminal in the plug which is marked with the letter «N» or coloured black.

Connect the brown (live) wire to the terminal in the plug which is marked with the letter «L» or coloured red.

The plug moulded onto the lead incorporates a fuse.

For replacement, use a 13 amp BSI362 fuse.  
Only ASTA or BSI approved fuses should be used.

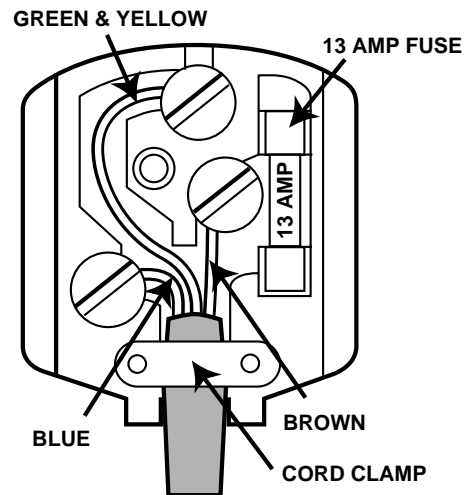

# ZANUSSI

© Electrolux Household Appliances Limited 2002

 **From the Electrolux Group.** *The world's No. 1 choice.*

*The Electrolux Group is the world's largest producer of powered appliances for kitchen, cleaning and outdoor use. More than 55 million Electrolux Group products (such as refrigerators, cookers, washing machines, vacuum cleaners, chain saws and lawn mowers) are sold each year to a value of approx. USD 14 billion in more than 150 countries around the world.*

CE

**AGB** 02-03